

AIRSTREAM®

OWNER'S MANUAL

2026

INTERSTATE® 19X



Roll With The Best®

User Guide Videos and Airstream Academy

Scan the QR code on the cover or visit <https://support.airstream.com> to view model-specific User Guide Videos that explore topics discussed in this manual. Visit Airstream Academy at <https://www.airstream.com/academy/> to learn the ins and outs of Airstreaming by exploring videos, articles, and frequently asked questions covering a wide range of popular RV topics.

⚠ WARNING

Operating, servicing and maintaining a passenger vehicle or off-road vehicle can expose you to chemicals including engine exhaust, carbon monoxide, phthalates, and lead, which are known to the State of California to cause cancer and birth defects or other reproductive harm. To minimize exposure, avoid breathing exhaust, do not idle the engine except as necessary, service your vehicle in a well-ventilated area and wear gloves or wash your hands frequently when servicing your vehicle. For more information go to www.P65Warnings.ca.gov/passenger-vehicle

California Consumers

CALIFORNIA CONSUMERS: To comply with California's Song Beverly Consumer Warranty Act pre-litigation notice requirements (described at California Code of Civil Procedure Section 871.24), written notice can be sent to Airstream, Inc., either by email sent to the following email address: support@airstream.com, or by certified or registered mail, return receipt requested, sent to the following address: Airstream, Inc., 428 West Pike Street, P.O. Box 629, Jackson Center, Ohio 45334-0629, Attention: Owner Relations Department.

CONSUMIDORES DE CALIFORNIA: Para cumplir con los requisitos de notificación previa al litigio de la Ley de Garantía del Consumidor Song Beverly de California (descritos en la Sección 871.24 del Código de Procedimiento Civil de California), se puede enviar una notificación por escrito a Airstream, Inc., ya sea por correo electrónico a la siguiente dirección de correo electrónico: support@airstream.com, o por correo certificado o registrado, con acuse de recibo, enviado a la siguiente dirección: Airstream, Inc., 428 West Pike Street, P.O. Box 629, Jackson Center, Ohio 45334-0629, Attention: Owner Relations Department.

Disclaimer And Copyright

All information, illustrations and specifications contained in this manual are based on the latest product information available at the time of publication approval. If and when new materials and production techniques are developed that can improve the quality of its product, or material substitutions are necessary due to availability, Airstream reserves the right to make such changes.

Airstream Interstate 19X Owner's Manual

©2025 Airstream, Inc. All rights reserved

Publication Date: November 2025

REV# 03

AIRSTREAM®

TABLE OF CONTENTS

INTRODUCTION	1-1	SPRINTER VAN	7-1
SAFETY	2-1	Important Sprinter Information	7-2
Safety Precautions	2-2	Tires	7-4
Chemical Sensitivity and Ventilation	2-2	Changing A Tire	7-6
Alarms and Detectors	2-3	Installing and Removing A Wheel	7-8
Diesel Exhaust	2-7	Tire Rotation	7-9
Fire Extinguisher	2-7	DRIVING	8-1
Emergency Exit	2-8	Loading	8-2
GENERAL INFORMATION	3-1	Safety	8-4
2-Year Airstream Limited Warranty	3-2	Trailer Towing and Driving Tips	8-4
Sprinter Van Information	3-5	Towing a Trailer	8-6
Service	3-5	Towing Your Touring Coach	8-9
Camping	3-6	Safety Check List	8-9
FLOOR PLANS AND SPECIFICATIONS	4-1	MAINTENANCE	9-1
Floor Plan	4-2	Maintenance Schedule	9-2
Specifications	4-3	Airstream Service and Parts	9-3
INTERIOR	5-1	Tire Care	9-3
General Information and Cleaning	5-3	Plumbing	9-4
Electrical System Overview	5-8	Drain and Waste System	9-6
Electrical System Operation	5-11	Winterizing and Storage	9-8
Entertainment Systems	5-20	Electrical Diagrams	9-13
Appliances	5-21	Fresh Water Layout	9-22
EXTERIOR	6-1	FAQs and Answers	9-23
Exterior Care	6-2		
Exterior Components	6-4		
Exterior Features	6-6		
Awning	6-9		
Screen Doors	6-11		

AIRSTREAM®

Section 1 INTRODUCTION

The Owner's Manual for your new Airstream Touring Coach is designed to respond to the most frequent inquiries regarding the operation, function, and care of the many systems that make modern motorhoming a joy.

The Airstream Touring Coach is integrated into a Sprinter Van, designed and manufactured by Mercedes-Benz. Operation of the Sprinter, its engine, power train, and other related components are discussed in the Mercedes-Benz Sprinter Operator's Manual and other literature provided by Mercedes-Benz. Those systems discussed in the Sprinter literature are warranted by Mercedes-Benz or their suppliers.

Airstream realizes our customers possess varying degrees of expertise in the area of maintaining and repairing the appliances in their touring coach. For this reason, the service and trouble-shooting information found in this manual is directed toward those with average mechanical skills. We also realize you may be more familiar in one area than you are in another. Only you know your capabilities and limitations.

We want you to use this manual, and hope you will find the information contained in it helpful; however, should you ever feel you may be "getting in over your head," please see your dealer to have the repairs made.

The operation and care of component parts such as, refrigerator, heating and hot water system, and others are briefly explained in this manual.

All information, illustrations, and specifications contained in this manual are based on the latest product information available at the time of publication approval. Airstream reserves the right to make changes if and when new materials and/or production techniques are developed that can improve the quality of its product, or when material substitutions are necessary due to availability.

Optional items may be available on all, or particular models. Additionally, some optional items can only be included during the manufacturing phase and cannot later be added to the touring coach. The inclusion of optional items information in this manual does not imply or suggest the availability, application, suitability, or inclusion for any specific unit.

WARNING

Your Mercedes-Benz Sprinter Van Operator's and Warranty Manuals contain important cautions, warnings, operational, and warranty information on the Sprinter and its components. All information in the Sprinter manual should be reviewed and followed for your safety. The Airstream Owner's Manual may provide additional information and tips on the use of the van as a touring coach; however, no information in the Airstream manual should be interpreted as advice or directions to disregard or void the warnings, cautions, or other information contained in the Sprinter's manuals.

Airstream uses the  safety alert symbol and signal words Danger, Warning, and Caution to alert you to potential personal injury hazards. Obey all safety messages that follow this symbol to avoid possible injury or death. The following are examples of each type of signal word, safety message, and information message found throughout this manual.

DANGER

Indicates a hazardous situation which, if not avoided, will result in death or serious injury.

WARNING

Indicates a hazardous situation which, if not avoided, could result in death or serious injury.

CAUTION

Indicates a hazardous situation which, if not avoided, could result in minor or moderate injury.

NOTICE

Indicates a potential situation which, if not avoided, may result in damage to your Airstream. Addresses practices not related to personal injury.

NOTE

Provides noteworthy information and tips about your Airstream.

AIRSTREAM®

Section 2 SAFETY

SAFETY PRECAUTIONS	2-2	ALARMS AND DETECTORS	2-3
Weight Distribution	2-2	Smoke Alarm/Carbon Monoxide Detector	2-3
Tire Safety	2-2	Smoke Alarm	2-3
Electrical Appliances and Outlets	2-2	Batteries Low	2-4
Diesel Operated Systems	2-2	This Carbon Monoxide Detector Is Not	2-4
Mold	2-2	Important Safety Precautions	2-4
CHEMICAL SENSITIVITY AND VENTILATION	2-2	What Is Carbon Monoxide	2-5
Chemical Sensitivity	2-2	Conditions that can result in potentially dangerous CO situations	2-5
Formaldehyde	2-2	Symptoms of Carbon Monoxide Poisoning	2-5
Ventilation	2-3	Regular Maintenance of Smoke/CO Detector	2-6
Do Not Smoke	2-3	Testing the Smoke/CO Detector	2-6
Medical Advice	2-3	DIESEL EXHAUST	2-7
		Engine and Heating and Hot Water System Safety	2-7
		FIRE EXTINGUISHER	2-7
		EMERGENCY EXIT	2-8
		Safety	2-8

Safety Precautions

Many things can be construed as safety related, but the most important is your common sense. If you are careless with matches, cigarettes, flammable material, or any other hazardous material, you surely realize your potential for accidents is greatly increased.

You will find many safety recommendations in this section and throughout the manual. The following recommendations are the ones we consider to be the most important.

Weight Distribution

Touring coach's have fresh water and waste water tanks, a water heater, and storage areas. It gives you great flexibility in loading. With flexibility comes responsibility. If you want to load down all the storage compartments, the amount of fluids may have to be reduced. It is a trade off so plan wisely. Distribute your additional cargo as evenly as possible with the heaviest objects located as low as possible. For detailed information on loading and weight distribution, see [Loading on page 8-2](#).

Tire Safety

Properly maintained tires improve the steering, stopping, traction, and load-carrying capability of your vehicle; see [Tire Care on page 9-3](#).

Electrical Appliances and Outlets

Improper handling of electrical components can be fatal. Do not touch or use electrical components or appliances with bare feet, while hands or feet are wet, or while standing in water or on damp ground.

Diesel Operated Systems

The diesel powered function of the heating/hot water system and touring coach engine run on diesel fuel. Do not start the diesel fired option on the heating/hot water system or the vehicle engine in closed garages or other enclosed or confined areas. For more information, see [What Is Carbon Monoxide on page 2-5](#) and see [Diesel Exhaust on page 2-7](#).

Mold

Mold and mold spores exist throughout indoor and outdoor environments. There is no practical way to eliminate all mold and mold spores in the indoor environment; however, the way to control indoor mold growth is to control moisture; see [What factors contribute to mold growth on page 3-9](#).

Chemical Sensitivity and Ventilation

Chemical Sensitivity

Immediately after the purchase of your new recreational vehicle and sometimes after it has been closed up for an extended period of time, you may notice a strong odor and/or experience a chemical sensitivity. This is not a defect in your recreational vehicle. Like your home, there are many different products used in the construction of recreational vehicles, such as carpet, linoleum, plywood, insulation, upholstery, etc. Formaldehyde is also the by-product of combustion and numerous household products, such as some paints, coatings, and cosmetics. However, recreational vehicles are much smaller than your home and therefore, the exchange of air inside a recreational vehicle is significantly less than in a home. These products, when new or when exposed to elevated temperatures and/or humidity, may off-gas different chemicals, including formaldehyde. This off-gassing, in combination with the minimal air exchange, may cause you to experience irritation of the eyes, nose, and throat, as well as sometimes headache, nausea, and a variety of asthma-like symptoms. Elderly persons and young children, as well as anyone with a history of asthma, allergies, or lung problems, may be more susceptible to the effects of off-gassing.

Formaldehyde

Formaldehyde is a naturally occurring substance and is an important chemical used widely by industries to manufacture building materials and numerous household products. It is also a by-product of combustion and certain other natural processes. Thus, it may be present inside the touring coach. Ventilation of the unit normally reduces the exposure to a comfortable level.

Trace levels of formaldehyde are released from smoking, cooking, use of soaps and detergents, such as carpet shampoos and cosmetics, and many other household products. Some people are very sensitive to formaldehyde while others may not have any reaction to the same levels of formaldehyde. Amounts released decrease over time.

Your Airstream touring coach was manufactured using low formaldehyde-emitting (LFE) wood products, the use of which is typical in the recreation vehicle industry. Formaldehyde has an important role in the adhesives used to bind wood products used in recreation vehicles. The wood products in your coach are designed to emit formaldehyde at or lower than industry guidelines and should not produce symptoms in most individuals.

While LFE wood products typically do not emit formaldehyde at a level that would cause symptoms in most individuals, it is possible, though not likely, for symptoms to occur when the touring coach is not properly ventilated. Ventilation is an essential requirement for touring coach use for many reasons. Any effects of formaldehyde can be greatly reduced by actions such as opening windows, opening roof vents, running the air conditioner, or some combination thereof. In addition, the emission of formaldehyde by these products naturally decreases rapidly over time.

Airstream strongly suggests you take measures to properly ventilate your touring coach on a regular basis. If you have any questions with respect to proper ventilation of your touring coach, please do not hesitate to contact your dealer or Airstream.

Ventilation

To reduce or lessen exposure to chemicals from off-gassing, it is of the utmost importance that you ventilate your recreational vehicle. Ventilation should occur frequently after purchase and at times when the temperatures and humidity are elevated. Remember, off-gassing is accelerated by heat and humidity. Open windows, exhaust vents, and doors. Operate ceiling and/or other fans, roof AC, and use a fan to force stale air out and bring fresh air in. Decreasing the flow of air by sealing the recreational vehicle increases the formaldehyde level in the vehicle's indoor air.

Do Not Smoke

It is recommended you do not smoke inside your recreational vehicle. In addition to causing damage to your recreational vehicle, tobacco smoke releases formaldehyde and other toxic chemicals.

⚠ WARNING

Do not smoke when drowsy. Remove immediately any flowing ash or lit cigarette which falls on furniture. Smoldering/smoking material can cause upholstered furniture fires.

Medical Advice

Questions regarding the effects of formaldehyde on your health should be submitted to your doctor or local health department.

Alarms and Detectors

Parts of this section on the combination Smoke/Carbon Monoxide Detector are a reprint of the manual included with the device and provided to you in the Airstream owner's packet.

Carefully read and understand the contents of the provided instruction manual before using the detector. Store the manual in a safe place for future reference. Pay particular attention to the safety warnings. Pass the manual on to any subsequent users of the alarm.

If you have not received the manual, contact your dealership to obtain one, or contact Airstream Customer Relations at 937-596-6111.

⚠ WARNING

Dangers, Warnings, and Cautions alert you to important operating instructions or to potentially hazardous situations. Pay special attention to these items.

Smoke Alarm/Carbon Monoxide Detector



Smoke Alarm

Power/Smoke LED: Flashes RED
Horn: 3 BEEPS, pause, 3 BEEPS, pause
CO LED: Off

Carbon Monoxide Alarm

CO LED: Flashes RED
Horn: 4 BEEPS, pause, 4 BEEPS, pause
Power/Smoke LED: Off

⚠ WARNING

If either alarm sounds, exit immediately and call the Fire Department. In the event of a carbon monoxide alarm, exit immediately and move everyone to a source of fresh air. Do not remove the batteries.

Batteries Low

The Smoke/Carbon Monoxide Detector will “chirp” once a minute for at least 30 days when the batteries are weak. The battery must immediately be replaced with a fresh one. The unit may beep briefly when you install the batteries. This is normal. The GREEN light flashes about every 60 seconds when the unit is receiving battery power.

⚠ WARNING

Smoke/Carbon Monoxide detectors have a limited life. The unit should be replaced immediately if it is not operating properly. You should always replace an alarm after 5 years from the date of purchase. Write the purchase date on the space provided on the back of unit.

⚠ WARNING

This product is intended for use in ordinary, indoor locations of family living units. It is not designed to measure compliance with occupational safety and health administration (OSHA) commercial or industrial standards. Individuals who are at special risk from Carbon Monoxide exposure by reason of age, pregnancy, or medical condition may consider using warning devices which provide audible and visual signals for Carbon Monoxide concentration under 30 ppm. If in doubt, consult your medical practitioner.

⚠ WARNING

Activation of your Carbon Monoxide alarm’s audible horn indicates the presence of Carbon Monoxide that can kill you. Leave the area immediately!

This Carbon Monoxide Detector Is Not

- Designed to detect any gas other than Carbon Monoxide.
- To be seen as a substitute for the proper servicing of fuel-burning appliances.
- To be used on an intermittent basis, or as a portable alarm for spillage of combustion products from fuel-burning appliances.

⚠ WARNING

This Carbon Monoxide detector is designed for indoor use only. Do not expose to rain or moisture. Do not knock or drop the alarm. Do not open or tamper with the alarm as this could cause malfunction. The detector will not protect against the risk of Carbon Monoxide poisoning when the batteries are dead or missing. The alarm will only indicate the presence of Carbon Monoxide gas at the sensor. Carbon Monoxide gas may be present in other areas.

Important Safety Precautions

- Ideally, it is recommended that a Carbon Monoxide detector should be installed in or near every room that has a fuel burning appliance such as any room heaters, water heaters, cookers, grills, etc.
- Ensure that the alarm horn can be heard by all those who are intended to hear it. Seek medical help if it is suspected that a user of the RV is suffering from Carbon Monoxide poisoning.
- If the alarm sounds, make sure to investigate the problem. Ignoring the alarm may result in sickness, injury or death. (CO may be present even if nothing is seen or smelled by the user.)
- Room spaces should be well ventilated when household cleaning supplies are used as these may cause a false alarm.
- Alarm should be tested once per week. If further details are required, which do not appear in this manual, contact BRK Brands Inc. First Alert.

What Is Carbon Monoxide

Carbon Monoxide (CO) is a highly poisonous gas that is released when fuels are burned. It is invisible, has no smell, and is therefore very difficult to detect with the human senses. Under normal conditions, in a room where fuel-burning appliances are well maintained and correctly ventilated, the amount of CO released into the room by appliances is not dangerous.

These fuels include wood, coal, charcoal, oil, natural gas, gasoline, diesel fuel, kerosene, and propane. Common appliances are often sources of CO. If they are not properly maintained, are improperly ventilated, or malfunction, CO levels can rise quickly. CO is a real danger in air-tight vehicles with added insulation, sealed windows, and other weatherproofing that can trap CO inside.

Conditions that can result in potentially dangerous CO situations

1. Excessive spillage or reverse-venting of fuel-burning appliances caused by outdoor conditions, such as:
 - Wind direction and/or velocity, including high gusts of wind.
 - Heavy air in the vent pipes (cold/humid air with extended periods between cycles).
 - Negative pressure differential resulting from use of exhaust fans.
 - Simultaneous operation of several fuel-burning appliances competing for limited internal air.
 - Vent-pipe connections vibrating loose from clothes dryers, furnaces, or water heaters.
 - Obstructions in or unconventional vent-pipe designs which can amplify the above situations.
2. Extended use of un-vented fuel burning devices.
3. Temperature increase that can trap exhaust gases near the ground.

Symptoms of Carbon Monoxide Poisoning

- Mild Exposure - Slight headache, nausea, vomiting, fatigue (flu-like symptoms).
- Medium Exposure - Throbbing headache, drowsiness, confusion, fast heart rate.
- Extreme Exposure - Convulsions, unconsciousness, heart and lung failure. Exposure to CO can cause brain damage and/or death.

 WARNING

The Smoke/CO detector is shipped with batteries deactivated. Ask your dealer to activate batteries or activate batteries immediately upon delivery. Failure to follow this warning will remove your protection.

 DANGER

Many causes of reported CARBON MONOXIDE POISONING indicate that while victims are aware that they are not well, they become so disoriented that they are unable to save themselves by either exiting the area or calling for assistance. Also young children and pets may be the first to be affected.

 WARNING

Test Units in your touring coach after the vehicle has been in storage, before each trip, and at least once a week while in use. If the alarm ever fails to test correctly, have it replaced immediately. If the alarm is not working properly, it cannot alert you to a problem. Failure to test units used in RVs as described may remove your protection.

Regular Maintenance of Smoke/CO Detector

The Smoke/CO detector has been designed to be as maintenance-free as possible, but there are a few simple things you must do to keep it working properly. Use replacement batteries as indicated in the manual included with the device and provided to you in the Airstream owner's packet. The unit may not operate properly with other batteries. Never use rechargeable batteries since they may not provide a constant charge.

Testing the Smoke/CO Detector

PRESS and HOLD the TEST/SILENCE button 3-5 seconds until the unit starts to alarm. During testing, you will see and hear the following sequence:

- The Horn will sound 3 BEEPS, pause, 3 BEEPS. The Power/Smoke LED flashes Red and the CO LED will be Off.
- Next the Horn will sound 4 BEEPS, pause, 4 BEEPS. The Power/Smoke LED will be Off and the CO LED flashes Red.
- Test it at least once a week.
- Clean the Smoke/CO Alarm at least once a month: gently vacuum the outside of the alarm using your household vacuum's soft brush attachment. A can of clean, compressed air (sold at computer or office supply stores) may also be used. Follow manufacturer instructions for use. Never use water, cleaners, or solvents, since they may damage the unit.
- If the alarm becomes contaminated by excessive dirt, dust, and/or grime, and cannot be cleaned to avoid unwanted alarms, replace the unit immediately.

⚠ WARNING

The battery door will resist closing unless batteries are installed. This warns you that the unit will not operate without batteries.

⚠ DANGER

Carbon Monoxide is poisonous and can cause confusion, unconsciousness, and death. Follow all instructions, cautions, and warnings in this section.

⚠ WARNING

NEVER ignore any alarm. Failure to respond can result in injury or death. The Silence Features are for your convenience only and will not correct a problem. Always check your touring coach for a potential problem after any alarm. Failure to do so can result in injury or death.

Diesel Exhaust

Engine and Heating and Hot Water System Safety

The touring coach engine and diesel powered function of the heating/hot water system run on diesel fuel and expel exhaust fumes externally. To avoid unsafe conditions or exposure to fumes and safely run the engine and hydronic system:

1. DO NOT run the engine or diesel powered function of the heating/hot water system in an enclosed building or a partly enclosed area such as a garage.
2. DO NOT operate the engine or diesel powered function of the heating/hot water system when parked close to objects that could block the exhaust and force fumes inside; examples include thick vegetation, snow, buildings, and other vehicles.
3. DO NOT operate the engine or diesel powered function of the heating/hot water system when parking the vehicle in high grass or brush. The heat from exhaust system components could cause a fire in dry conditions.
4. DO NOT touch any part of either exhaust system when the engine or heating/hot water system is running or immediately after shutting off. The heat coming off exhaust systems can cause burns. Allow the exhaust(s) to cool before attempting maintenance or service.

 DANGER

Diesel engines produce carbon monoxide. Exposure to diesel exhaust fumes may cause headaches, nausea, chest tightness, wheezing, cough, and irritation of the eyes, nose, and throat, and in high concentrations can be fatal.

 WARNING

Hot exhaust system components can cause burns if touched, even briefly.

Fire Extinguisher



The fire extinguisher should be checked for charge on a regular basis. Make sure your family knows how to release the extinguisher storage bracket and how to properly operate the extinguisher. Check with your local fire department for professional advice on its operation and use if you find the directions on the extinguisher unclear. They will be able and willing to assist you and your family.

 WARNING

Read the directions carefully on the fire extinguisher. If there is any doubt on the operation you and your family should practice, then replace or recharge the extinguisher. You will find your local fire department will be happy to assist you and answer any questions.

 WARNING

Do not smoke inside the touring coach. Keep matches out of reach of small children. Do not bring flammable liquids inside the RV or clean with flammable materials. Keep flammable materials away from open flames. We have all heard these warnings many times, but they are still among the leading causes of fires.

Emergency Exit

There are three avenues of escape from the touring coach in the event of an emergency, the driver's door, the passenger door, and the rear doors. As always, safety should be one of your top priorities. Make sure you and everyone traveling with you can operate these doors and exit rapidly without light. A little planning and a quick practice session at each camping site is well worth the time it may take.

Safety

As always, safety should be a top priority. Ensure that you, and everyone traveling with you, can quickly operate the main door and rear doors in the dark. Plan for other means of escape in case these designated exits are blocked.

⚠ DANGER

At each campsite, make sure you have not parked in such a manner as to block the operation of the doors or the escape avenues by being too close to trees, fences, or other impediments. Scenic views are one reason for traveling, but do not park so the beautiful lake or steep cliff is just outside your doors. Do not block access to the doors from the inside or outside of the vehicle.

AIRSTREAM®

Section 3 GENERAL INFORMATION

2-YEAR AIRSTREAM LIMITED WARRANTY . . .	3-2	CAMPING	3-6
SPRINTER VAN INFORMATION	3-5	Suggested Pre-Travel Check List	3-6
SERVICE.	3-5	Exterior	3-6
Coach-Net® Roadside Assistance	3-5	Interior	3-6
Service Centers	3-5	Touring Coach Equipment and Accessories	3-6
Reporting Safety Defects	3-6	Motoring Essentials	3-6
		Overnight Stop	3-7
		Overnight or Weekend Trips	3-7
		Longer Trips	3-7
		Extended Stay	3-7
		Leveling	3-7
		Effects of Prolonged Occupancy	3-8
		About Molds	3-9
		What are molds	3-9
		What factors contribute to mold growth . . .	3-9
		How can mold growth be inhibited	3-9
		Wastewater System	3-9
		Things Not to Put into Toilet or Drains . .	3-9
		Drain System	3-10
		Winter Traveling	3-10
		Heated Tanks	3-11

General Information

2-Year Airstream Limited Warranty

AIRSTREAM®

1001 West Pike St., Jackson Center, OH 45334-0629

2026 INTERSTATE 2-YEAR AIRSTREAM LIMITED WARRANTY

Delivery Date: _____

Airstream Serial Number: _____

Chassis Serial Number: _____

PURCHASED BY: _____

PURCHASED FROM: _____

Name: _____

Dealer Name: _____

Address: _____

Address: _____

City/State: _____ Zip: _____

City/State: _____ Zip: _____

THIS LIMITED WARRANTY COVERS: (i) The first retail owner and any subsequent owners for a period of 2 years; (ii) ONLY those portions of a NEW motorhome not excluded under the section "What is Not Covered," when sold by an authorized dealership and used for its intended purpose of recreational travel and camping; and, (iii) ONLY defects in workmanship performed and/or materials used to assemble those portions of your motorhome not excluded under the section "What is Not Covered." "Defect" means the failure of the workmanship performed and/or materials used to conform with the design and manufacturing specification and tolerances of Airstream. This Limited Warranty is transferable, and the subsequent owner's warranty coverage period shall be the unexpired balance of the original warranty coverage period. A completed copy of the Warranty Transfer Form must be submitted to Airstream at the time of resale.

When you request and accept the performance of warranty repairs under the terms of this Limited Warranty, you are accepting all terms of this Limited Warranty, including by way of example, warranty limitations and disclaimers, the forum selection clause and the clause reducing the time period when suit must be filed for breach.

If any term or condition in this Limited Warranty conflicts with your state's Uniform Commercial Code ("UCC") as interpreted by courts within your state, the provisions of your state's UCC are varied as allowed for by USS 1-302.

COVERAGE ENDS: 24 months after the first retail owner first takes delivery of the motorhome from an authorized dealership. Delivery occurs when the retail owner takes physical possession of the motorhome or has alterations done to it, whichever occurs first. ANY ACTION FOR BREACH OF THIS WARRANTY OR ANY IMPLIED WARRANTIES MUST BE COMMENCED NOT MORE THAN 25 MONTHS AFTER DATE OF DELIVERY. Some states do not allow the reduction of the time when a breach of warranty claim must be commenced, so the reduction in time when a breach of warranty claim must be commenced may not apply to you.

LIMITATION OF IMPLIED WARRANTIES: IMPLIED WARRANTIES ARISING UNDER APPLICABLE LAW, IF ANY, INCLUDING BUT NOT LIMITED TO IMPLIED WARRANTIES OF MERCHANTABILITY OR FITNESS FOR A PARTICULAR PURPOSE, ARE HEREBY LIMITED IN DURATION TO THE TERM OF THIS WARRANTY AND ARE LIMITED IN SCOPE OF COVERAGE TO THOSE PORTIONS OF THE MOTORHOME COVERED BY THIS WARRANTY. THERE ARE NO EXPRESS WARRANTIES OR ANY IMPLIED WARRANTIES OF MERCHANTABILITY ON THOSE PORTIONS OF THE MOTORHOME EXCLUDED FROM COVERAGE. There is no warranty of any nature made by Airstream beyond that contained in this Limited Warranty. No person has authority to enlarge, amend, or modify this Limited Warranty. The dealer is NOT Airstream's agent. Airstream is not responsible for any undertaking, representation, or warranty made by any dealer or others beyond those expressly set forth within this Limited Warranty. SOME STATES DO NOT ALLOW LIMITATIONS ON HOW LONG AN IMPLIED WARRANTY LASTS, SO THE ABOVE LIMITATIONS MAY NOT APPLY TO YOU.

DISCLAIMER OF INCIDENTAL AND CONSEQUENTIAL DAMAGES: Airstream disclaims any and all incidental and consequential damages, including but not limited to expenses such as transportation to and from dealerships and Airstream repair facilities, loss of time, loss of pay, loss of use, inconvenience, commercial loss (including but not limited to lost profits), towing charges, bus fares, vehicle rental, service call charges, gasoline expenses, incidental charges such as telephone calls and facsimile transmissions, and expenses for lodging and moisture damage such as mold and mildew as well as rust and corrosion. This disclaimer is independent of any failure of the essential purpose of any warranties provided with the motorhome and shall survive any determination that a warranty failed of its essential purpose. Some states do not allow the exclusion or limitation of incidental or consequential damages, so the above limitation or exclusion may not apply to you.

REPAIR REMEDY: Airstream's sole and exclusive obligation is to repair any covered defects discovered within the warranty coverage period if: (1) within 10 days of your discovery of a defect, you notify Airstream OR an authorized dealership of the defect; AND (2) you deliver your motorhome to Airstream OR an authorized dealership at your cost and expense.

BACK-UP REMEDY: If the primary repair remedy fails to successfully cure any defect after a reasonable number of repair attempts, your sole and exclusive remedy shall be to have Airstream pay an independent service shop of your choice to perform repairs to the defect, which requires the exercise of good faith. If you select an independent service shop, you must notify Airstream to allow it to work directly with the service shop to have repairs performed. The repair remedy and the back-up remedy MUST both be exhausted AND these remedies must fail to fulfill their essential purpose before you can seek other legal or equitable remedies for breach of this express warranty or for breach of any implied warranty. THIS LIMITED WARRANTY IS NOT A WARRANTY THAT PROMISES OR EXTENDS TO FUTURE PERFORMANCE BECAUSE THE WARRANTY DOES NOT MAKE A REPRESENTATION ON HOW YOUR MOTORHOME WILL PERFORM IN THE FUTURE BUT INSTEAD REPRESENTS ONLY WHAT THE REMEDY WILL BE IF A DEFECT EXISTS.

Unless prohibited by state law, repairs will not extend the time when you must commence a breach of warranty claim and shall not extend the warranty coverage period. Any performance of repairs after the warranty coverage ends OR any performance of repairs to those portions of your motorhome excluded from coverage shall be considered “good will” repairs. Warranty repairs should be expected. Airstream may use new and/or remanufactured parts and/or components of substantially equal quality to complete a repair. Damage to interior or exterior surfaces, trim, upholstery, and other appearance items may occur at the factory during assembly, during delivery of the motorhome to your selling dealer or on the selling dealer’s lot. Normally, any damage is detected and corrected at the factory or by the selling dealer during the inspection process. If you discover any damage when you take delivery of your motorhome, you MUST notify your dealer OR Airstream within 10 days of the date of purchase to have damage repaired at no cost to you. Minor adjustments, such as adjustments to the interior or exterior doors, drawers, and latches will be performed at no cost to you by your selling dealer during the first 90 days of warranty coverage; thereafter, such adjustments are your exclusive responsibility as normal maintenance.

WHAT IS NOT COVERED

1. The Mercedes-Benz chassis and power train, including, by way of example, the engine, drive-train, steering, ride and handling, braking, wheel balance, muffler, tire wear or failure, tubes, batteries and gauges, suspension, exterior shell, exterior doors, etc.
2. Accessories and equipment that are working as designed, but which you are unhappy because of the design;
3. Normal deterioration due to wear or exposure, including but not limited to floor coverings, rust, corrosion, oxidation, and cosmetic blemishes. In addition, this Limited Warranty does not apply to consumable parts that are designed to diminish over time, unless failure has occurred due to a defect in materials or workmanship;
4. Normal maintenance and service items, including but not limited to batteries, tires, glass breakage, fuses, bulbs, lubricants, sealants and seals, door adjustments, and awning tension. In addition, this Limited Warranty does not apply to consumable parts that are designed to diminish over time, unless failure has occurred due to a defect in materials or workmanship;
5. After-market equipment or accessories installed on the motorhome after completion of manufacture by Airstream, or any defects or damage caused by such items;
6. Motorhomes not purchased through an authorized dealer of Airstream and motorhome’s purchased directly or indirectly through auction, salvage, repossession, or other non-customary sale means.
7. Any motorhome used other than for temporary recreation purposes, including, but not limited to, use of the motorhome for residential, rental, business and commercial purposes, or any motorhome purchased by, registered by, or titled in the name of a business association (such as any LLC, corporation, or partnership). If the motorhome owner or user files a tax form claiming a business or commercial tax benefit or income related to the motorhome, it shall be irrefutable that the motorhome has been used for rental, commercial or business purposes.
8. Defects or damage caused by, in whole or in part, or in any way related to: Accidents, misuse (including off-road use), or negligence; Failure to comply with the instructions set forth in any owner’s manual provided with the motorhome; Alteration or modification of the motorhome except such alterations or modifications approved in writing by Airstream; Acts of God or other environmental conditions, such as lightning, hail, salt causing rust, or other chemicals in the atmosphere; De-icing agents or other chemicals applied to the motorhome; Failure to properly maintain or service the motorhome, including but not limited to the maintenance of lubricants, sealants, and seals; Condensation and the results of condensation including water damage and the growth of mold or mildew (mold and mildew are natural growths given certain environmental conditions and are not covered by the terms of this Limited Warranty); The addition of weight to the motorhome that causes the total weight to exceed applicable vehicle weight ratings, or addition of weight causing improper distribution of the weight of the motorhome; Failure to seek and obtain repairs in a timely manner; Failure to use reasonable efforts to mitigate damage caused by defects; Failure to properly ventilate the motorhome; Improper electric power supply or improper motorhome hookup to other facilities; Acts or omissions of any person or entity other than Airstream.
9. Hardware or software of a third-party device that is connected to the motorhome or its components, even if integrated or delivered with the motorhome. Airstream is not responsible for the quality or accuracy of any information or service accessed through or from any third-party device or platform. Software distributed by Airstream inside or outside the motorhome (including, but not limited to, system software and/or applications) is not covered by this Limited Warranty. Airstream does not warrant that connections to, from or through the motorhome will be uninterrupted or error-free. Also, the user should back-up their data and information frequently. Airstream is not responsible for any loss or damage to data or information made available in connection with the use of the motorhome. In addition, this Limited Warranty does not apply to: (a) to damage caused by use with another product or service; (b) to damage caused by a third party device or service (including upgrades and expansions), or (c) to obsolescence or lack of utility due to incompatibility with future versions of external hardware or software, including, but not limited to mobile devices.

OBTAINING WARRANTY SERVICE: In order to obtain warranty service under this Limited Warranty, the owner must do all of the following:

1. Owner and dealer representative must complete, sign, and return the Customer Performance Checkout within 10 days from delivery of the motorhome;
2. Notify Airstream or one of its authorized, independent dealers, of any claimed defect within the warranty period or 10 days thereafter;
3. Provide notification of a defect within 10 days of discovery of that defect; and
4. Promptly return the motorhome to an authorized Airstream dealer or Airstream for repairs.

If you believe a defect covered by this Limited Warranty still exists after an attempted repair by an authorized Airstream dealer, you must contact Airstream in one of the following manners, and specify:

1. The complete serial number of the motorhome;
2. The date of original purchase and the date of original delivery;
3. The name of the selling dealer; and servicing dealer, if they are not the same.
4. The nature of the problem and the steps or service which have been performed.

Email: support@airstream.com • Phone: (937) 596-6111
 Mail: AIRSTREAM, INC., 428 West Pike Street, P.O. Box 629, Jackson Center, Ohio 45334-0629, Attention: Owner Relations Department

General Information

Airstream may direct you to an authorized Airstream dealer or may request that you bring your motorhome to the Airstream factory in Jackson Center, Ohio for repairs. Airstream does not control the scheduling of repairs at its authorized Airstream dealers, and repairs at the Airstream factory may not be immediately available. Therefore, you may encounter delays in scheduling repairs and/or completion of repairs. All costs associated with transporting the motorhome for any warranty service shall be the sole responsibility of the owner.

CONSUMER ARBITRATION PROGRAM: For recreation vehicles purchased in the State of California, Airstream, Inc. participates in the Consumer Arbitration Program for Recreation Vehicles (CAP-RV). This third-party dispute resolution program is available, at no charge to you, to settle unresolved warranty disputes for recreation vehicles. This dispute resolution program reviews eligible product and service related complaints involving warranty covered components. To find out more about this program, or to request an application/brochure, please call the Arbitration Administration office toll-free 800.279.5343. The CAP-RV program operates as a certified mechanism under the review of the California Arbitration Certification Program. Members of the armed forces who purchased the vehicle in California, or who were stationed in or a resident of California at the time of purchase (regardless of state of purchase) or who are stationed in California at the time of application to this program may utilize the CAP-RV program.

EVENTS THAT DISCHARGE AIRSTREAM'S OBLIGATIONS UNDER THIS LIMITED WARRANTY: Misuse or neglect, accidents, unauthorized alteration, failure to provide reasonable and necessary maintenance (see Owner's Manual), damage caused by off road use, collision, fire, theft, vandalism, explosions, overloading in excess of rated capacities, odometer tampering, and use of the motorhome for commercial, business, or rental purposes shall discharge Airstream from any express or implied warranty obligation.

LEGAL REMEDIES: EXCLUSIVE JURISDICTION FOR DECIDING LEGAL DISPUTES RELATING TO THE ALLEGED BREACH OF EXPRESS WARRANTY AND BREACH OF IMPLIED WARRANTIES ARISING BY OPERATION OF LAW AS WELL AS THOSE RELATING TO REPRESENTATIONS OF ANY NATURE RESTS IN THE COURTS WITHIN THE STATE OF MANUFACTURE, WHICH IS OHIO. ALSO, THIS WARRANTY SHALL BE INTERPRETED AND CONSTRUED IN ACCORDANCE WITH THE LAWS OF THE STATE OF OHIO. ANY AND ALL CLAIMS, CONTROVERSIES, AND CAUSES OF ACTION ARISING OUT OF OR RELATING TO THIS WARRANTY, WHETHER SOUNDING CONTRACT, TORT OR STATUTE, SHALL BE GOVERNED BY THE LAWS OF THE STATE OF OHIO, INCLUDING ITS STATUTE OF LIMITATIONS, WITHOUT GIVING EFFECT TO ANY CONFLICT OF LAW RULE THAT WOULD RESULT IN THE APPLICATION OF THE LAWS OF A DIFFERENT JURISDICTION. IF STATE LAW GIVES YOU ADDITIONAL RIGHTS THAT CONFLICT WITH ANY TERM OF THIS WARRANTY, YOUR STATE LAW APPLIES OVER INCONSISTENT WARRANTY TERMS. For example, if you took delivery of your RV in California, the Song Beverly Warranty Act and Consumers Legal Remedies Act apply because they cannot be waived.

I AGREE THAT ANY AND ALL ACTIONS OF ANY KIND RELATED TO MY MOTORHOME SHALL BE DECIDED BY A JUDGE RATHER THAN BY A JURY. THIS JURY WAIVER MAY NOT APPLY TO YOU IF APPLICABLE OR PROVINCIAL LAW PROHIBITS A WAIVER OF A JURY TRIAL. For example, if you took delivery in California, your right to a jury cannot be waived.

CALIFORNIA CONSUMERS: To comply with California's Song Beverly Consumer Warranty Act pre-litigation notice requirements (described at California Code of Civil Procedure Section 871.24), written notice can be sent to Airstream, Inc., either by email sent to the following email address: support@airstream.com, or by certified or registered mail, return receipt requested, sent to the following address: Airstream, Inc., 428 West Pike Street, P.O. Box 629, Jackson Center, Ohio 45334-0629, Attention: Owner Relations Department.

CONSUMIDORES DE CALIFORNIA: Para cumplir con los requisitos de notificación previa al litigio de la Ley de Garantía del Consumidor Song Beverly de California (descritos en la Sección 871.24 del Código de Procedimiento Civil de California), se puede enviar una notificación por escrito a Airstream, Inc., ya sea por correo electrónico a la siguiente dirección de correo electrónico: support@airstream.com, o por correo certificado o registrado, con acuse de recibo, enviado a la siguiente dirección: Airstream, Inc., 428 West Pike Street, P.O. Box 629, Jackson Center, Ohio 45334-0629, Attention: Owner Relations Department.

Before I purchased my motorhome, I received, read, and agreed to the terms and conditions of this Limited Warranty. I understand and agree that the selling dealership is not an agent for Airstream but is an independent entity. I understand and acknowledge items of the WHAT IS NOT COVERED section of this Limited Warranty. I acknowledge and agree that, before purchasing my motorhome, I inspected or was given an opportunity to inspect my motorhome and disclosed in writing to the selling dealership all defects and damage that I discovered during my test drive. For example, I inspected the underside of the RV for rust and did not discover any unless disclosed in writing to the selling dealership.

Purchaser Signature

Date

Purchaser Signature

Date

THIS WARRANTY GIVES YOU SPECIFIC LEGAL RIGHTS, AND YOU MAY ALSO HAVE OTHER RIGHTS WHICH VARY FROM STATE TO STATE.
AIRSTREAM, INC • 1001 West Pike Street • Jackson Center, Ohio 45334-0629 • Phone: 937-596-6111 • FAX: 937-596-6539

Sprinter Van Information

Airstream, Inc., does not accept any responsibility in connection with any of its touring coach's for the Sprinter Van or its components. The Sprinter Van and its components are covered by Mercedes-Benz Warranties as explained by Sprinter literature provided. Your Sprinter Van and its components are pre-checked by its manufacturer before delivery to Airstream. All service to the Sprinter Van and its components must be performed by Mercedes-Benz Sprinter designated service points according to the manufacturer's warranty and service policies. The literature provided with each touring coach gives important information concerning its warranty coverage, maintenance, and operation.

The Airstream Interstate Nineteen Owner's Manual may provide additional information and tips on the use of the van as a touring coach, however, no information, in whole or in part, in any Airstream manual should be interpreted as advice or directions to disregard or void the Warnings, Cautions, Notices, or other information contained in the Sprinter's manuals.

⚠ WARNING

Your Mercedes-Benz Sprinter Van Operator's and Warranty Manuals contain important cautions, warnings, operational, and warranty information on the Sprinter and its components. All information in the Sprinter manual should be reviewed and followed for your safety.

Service

Coach-Net® Roadside Assistance



Every new Airstream comes with a three-year, transferable subscription to Coach-Net which includes a long list of premium services to help quickly solve issues or learn about your Airstream.

To learn more, scan the QR code above, navigate to <https://www.airstream.com/owners/coach-net/>, or call Coach-Net at 855-817-1885. On-call technicians are always ready to answer questions.

Service Centers

Before leaving the factory, every vital part of the touring coach is tested for performance. Each test is signed and certified by an inspector. After the touring coach arrives on your dealer's lot, all vital parts and systems are again tested. When you take delivery of your new touring coach, you will receive a complete check out.

At that time, a specified list of performance checks on your touring coach equipment will be conducted, and any deficiencies you have experienced since taking delivery will be corrected.

Please contact your dealer if your touring coach needs service. Major service under your Airstream Limited Warranty is available through our nationwide network of Airstream Dealer Service Centers. To find a dealer, please visit, <https://www.airstream.com> to use our dealer locator.

Occasionally, dealerships change, or new dealers are added that may not appear on the website immediately. Please note that all centers operate on an appointment basis for the utmost efficiency.

When you require service for your touring coach from the Airstream Factory Service Center or a Certified Dealer Service Center, please contact the service manager for an appointment, and inform them if you are unable to keep the appointment date or wish to change it. Service may be arranged at the Factory Service Center by contacting the Service Coordinator at:

Airstream Factory Service Center
 428 West Pike Street
 P.O. Box 629
 Jackson Center, Ohio 45334-0629
 Phone: (937) 596-6111 or (877) 596-6111

NOTE

Connected RV features and systems may be turned off while in a service facility for the safety of our technicians. You might have to re-pair your personal device after service appointment.

General Information

Reporting Safety Defects

If you believe your vehicle has a defect which could cause a crash or could cause injury or death, you should immediately inform the National Highway Traffic Safety Administration (NHTSA), in addition to notifying Airstream, Inc.

If NHTSA receives similar complaints, it may open an investigation, and if it finds that a safety defect exists in a group of vehicles, it may order a recall and remedy campaign. However, NHTSA cannot become involved in individual problems between you, your dealer, or Airstream Inc.

To contact NHTSA, you may either call the Vehicle Safety Hotline toll-free at 1-888-327-4236 (TTY: 1-800-424-9153), go to <https://www.nhtsa.gov>, or write to:

Administrator

NHTSA

1200 New Jersey Avenue, S.E.

Washington, DC 20590

You can also obtain other information about motor vehicle safety from <https://www.nhtsa.gov>.

Camping

Suggested Pre-Travel Check List

Exterior

1. Verify power cord is stored.
2. Verify leveling jacks are up (if equipped).
3. Verify water and sewer hoses are stored.
4. Double check all hitch connections (if towing).
5. Look under, over, and around the vehicle for any overlooked items.
6. Check exterior lighting.
7. Check torque of wheel bolts or lug nuts.
8. Check tires for correct pressure.

Interior

1. Turn off water pump and heater/hot water system.
2. Close windows and vents.
3. Close all interior cabinet doors.
4. Latch refrigerator door. (Seal containers first.)
5. Latch microwave.
6. Secure, stow, and latch for travel anything that will move, fall, fly, or open.
7. Drain toilet bowl.
8. Turn off 12-volt lights.

Touring Coach Equipment and Accessories

1. Water hose, 5/8-in. high-pressure, tasteless, odorless, non-toxic (two 25-ft. sections).
2. Y connection - water hose.
3. Holding tank cleaner and deodorizer.
4. Power cord adapter, 15 amp - 30-amp.
5. 30-ft. electric cord, 30-amp capacity.
6. Wheel chocks.
7. Torque wrench.
8. Quality tire gauge.
9. Emergency light and first aid kits.

Motoring Essentials

1. Touring coach registration.
2. Carry driver's license.
3. In Canada, bring along a non-residence liability insurance card and your passport.
4. In Mexico, you must have special auto insurance.
5. Carry an extra set of the ignition keys in a separate pocket or in your wallet.
6. Keep an operating flashlight with fresh batteries in the glove compartment.
7. Pack the trunk so that you can reach the tools without completely unpacking.

Overnight Stop

In time you will develop a knack for spotting wonderful little roadside locations by turning off the main highway and exploring. There are many modern recreational vehicle parks, including State, County, and Federal parks with good facilities, where you may obtain electrical, water, and sewer hookups and connections. Directories are published which describe in detail these parks and tell what is available in the way of services and hookups.

All you need to do to enjoy the self-contained luxury while boondocking is to:

1. Turn on the Battery Power pushbutton (battery disconnect switch) to provide power to your components.
2. Inverter will need to be turned on to power the entertainment devices. To conserve battery power, turn off the inverter when not in use.
3. Turn on the water pump and open faucets until air is expelled from the system.

Before moving on, turn off the water pump and the heating/hot water system. Check your campsite, both for cleanliness and to be sure you have not left anything behind. Make sure everything is properly stowed.

Overnight or Weekend Trips

On overnight or weekend trips, chances are you will not use up the capacity of the holding tanks. Deplete the water supply, if using the system moderately or conservatively. You will need to maintain the level of your battery during longer periods of battery use, and when the State-of-Charge (SOC) is low.

Longer Trips

On a longer trip, when you have stayed where sewer connections and utility hookups were not available, it will be necessary for you to stop from time to time to dispose of the waste in the holding tank and replenish the water supply. Many truck stops and gas stations, chain and individually owned, have installed sanitary dumping stations for just this purpose. Booklets are available that list these facilities.

When you stop for the night, your Airstream Touring Coach is built to be safely parked in any spot that is relatively level and where the ground is firm. Your facilities are with you. You are self-contained. Try to pick as level a parking spot as possible.

Extended Stay

Making a long trip is not very different from making a weekend excursion. Since everything you need is right at hand, you are at home wherever you go. When packing for an extended trip, take everything you need, but only what you need.

Hook up to water by attaching a ½ -inch minimum high-pressure water hose to the city water service.

Plug the 120-volt, 30-amp electrical cable into the city power service. The SmartPlug incorporates a reverse polarity feature which will include a series of light codes to let you know the condition of the power coming from the campsite power pedestal. Please refer to the provided SmartPlug owner's manual for more information on reverse polarity and the light codes; also [see Shoreline Power Inlet and Cordset on page 6-8](#)

A Cable/Satellite TV connection is located in the exterior compartment along with the switches for the dump valves, macerator pump, and macerator pump high-pressure hose reel.

When you stay for extended periods where electric or water hookups are not available, you must make regular checks on State-of-Charge of your battery and the contents of your water tank (Multiplex control panel). Carry drinking water in a clean bucket to refill your tank. When your waste tank nears capacity, move your touring coach to a dumping location.

Leveling

When you plan to stay in the same place for several days, weeks, or months, you will want your touring coach to be as level as possible. Check the attitude with a small spirit level set on the inside work counter. If a correction is necessary, then you must first level from side to side. This can be done most easily by driving up a small ramp consisting of 2 in. x 6 in. boards tapered at both ends. Airstream does not recommend placing tires in a hole for leveling. For more information on tires, [see Tires on page 7-4](#).

General Information

Effects of Prolonged Occupancy

Your touring coach was designed primarily for recreational use and short-term occupancy. If you expect to occupy the touring coach for an extended period, be prepared to deal with condensation and the humid conditions that may be encountered. The relatively small volume and tight compact construction of modern recreation vehicles mean that the normal living activities of even a few occupants will lead to rapid moisture saturation of the air contained in the touring coach and the appearance of visible moisture, especially in cold weather.

Just as moisture collects on the outside of a glass of cold water during humid weather, moisture can condense on the inside surfaces of the touring coach during cold weather when relative humidity of the interior air is high. This condition is increased because the insulated walls of a recreation vehicle are much thinner than house walls. Estimates indicate that two adults can vaporize up to one-and-a-half gallons of water daily through breathing, cooking, bathing, and washing. Unless the water vapor is carried outside by ventilation or condensed by a dehumidifier, it will condense on the inside of the windows and walls as moisture, or in cold weather as frost or ice. It may also condense out of sight within the walls or the ceiling where it will manifest itself as warped or stained panels. Appearance of these conditions may indicate a serious condensation problem. When you recognize the signs of excessive moisture and condensation in the touring coach, action should be taken to minimize their effects.

NOTICE

Your touring coach is not designed, nor intended, for permanent housing. Use of this product for long term or permanent occupancy may lead to premature deterioration of structure, interior finishes, fabrics, carpeting, and drapes. Damage or deterioration due to long-term occupancy may not be considered normal, and may under the terms of the warranty constitute misuse, abuse, or neglect, and may therefore reduce the warranty protection.

To avoid condensation problems, try to follow these tips to help alleviate excess moisture:

- Allow excess moisture to escape to the outside when bathing, washing dishes, hair drying, laundering, and using appliances. Always use an exhaust fan when cooking.
- Keep the bathroom door closed and the vent or window open when bathing and for a period of time after you have finished.
- If you are experiencing condensation, you may want to reconsider hanging wet clothes in the touring coach to dry.
- In hot weather, start the AC early as it removes excess humidity from the air while lowering the temperature.
- Keep the temperature as reasonably cool during cold weather as possible. The warmer the vehicle, the more cold exterior temperatures and warm interior temperatures will collide on wall surfaces, thus creating condensation.
- Use the ceiling vent to keep air circulating inside the vehicle so condensation and mildew cannot form in dead air spaces. Allow air to circulate inside closets and cabinets (leave doors partially open). Please keep in mind that a closed cabinet full of stored goods prevents circulation and allows the exterior temperature to cause condensation.
- The natural tendency would be to close the vehicle tightly during cold weather. This will actually compound the problem. Simply put, you need to remove some of the warm air and allow some cool outside air to get inside the vehicle so the furnace will not recycle the humid interior air.
- Minimize the use of incandescent lights, which produce heat and contribute to condensation.

About Molds

What are molds

Molds are microscopic organisms that naturally occur in virtually every environment, indoors and out. Outdoors, mold growth is important in the decomposition of plants. Indoors, mold growth is unfavorable. Left unchecked, molds break down natural materials, such as wood products and fabrics. Knowing the potential risks is important for any type of homeowner to protect their investment.

What factors contribute to mold growth

For mold growth to occur, temperatures, indoor or outdoors, must be between 40°F and 100°F and also, there must be a source of moisture, such as humidity, standing water, damp materials, etc. Indoors, the most rapid growth occurs with warm and humid conditions.

How can mold growth be inhibited

By controlling relative humidity, the growth of mold and mildew can be inhibited. In warm climates, use of the air conditioner will reduce the relative humidity. Vents are located in the bathing and cooking areas and constant use is advised during food preparation and bathing, even during colder weather. Additionally, opening a window during these activities will assist in ventilation. In extremely humid conditions, the use of a dehumidifier can be helpful. If using a dehumidifier, please read and follow all manufacturer instructions and recommendations to the use and cleaning of the dehumidifier.

Frequent use of your touring coach or cleaning regularly is an important preventive measure. Further, any spills should be wiped up quickly and dried as soon as possible. Avoid leaving damp items lying about. On safe surfaces, use mold or mildew killing cleaning products. Check sealants regularly, and reseal when necessary to avoid water leaks. Proper preventive maintenance to the touring coach and its accessories, as described both in this manual and in accompanying literature, will provide the best protection to the touring coach.

Wastewater System

The main parts of the wastewater system are the toilet, holding tanks, and tank dump valves; [see Drain and Waste System on page 9-6](#). The system is designed to provide complete self-contained toilet facilities, while on the road or parked, without being connected to a sewage line. It may also be used when parked while connected to a sewage hose.

Keep the dump valves closed with either method and empty the tanks when they are nearly full. The idea is to send a large volume of water through the tanks and hose at the same time to float solids away.

After the sewage tank has been emptied, close the dump valves and charge the tank by putting a few gallons of water in the sewage holding tank using the waste tank flush inlet. This will spray the interior of the tank with water and help prevent solids from building up in the sewage holding tank. The addition of a deodorizing agent like Aqua-Kem will help prevent odors.

Should you ever have a buildup of solids, close the valves, fill the tanks about 3/4 full with fresh water, drive a distance to agitate the solids, and drain the tanks.

Things Not to Put into Toilet or Drains

- Facial tissues and feminine hygiene products (they do not dissolve like toilet paper).
- Automotive antifreeze, ammonia, alcohols, or acetone.
- Table scraps or other solids that may clog the drains.

General Information

Drain System

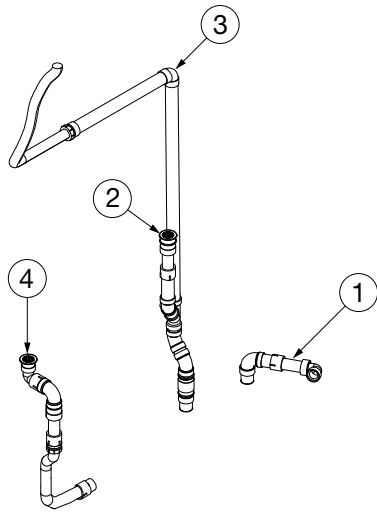

1. Shower, Side Drain
2. Lavy Sink Drain
3. Gray Tank Vent
4. Galley Sink Drain

Winter Traveling

Traveling in sub-freezing temperatures will require certain precautions to protect the plumbing system and your personal belongings from being damaged by freezing.

While traveling, simply use your common sense. How cold is it? How long will it be before you can turn the heat back on? Is the temperature dropping or rising? Remember, when driving at 50 MPH, the wind chill factor will cause the interior of the touring coach to cool much faster than a touring coach that is parked.

1. You must have at least 1/4 tank of fuel to run the diesel powered function of the heating/hot water system as the heat from the furnace warms the touring coach and keeps the fresh water lines and waste water holding tank from freezing. If your fuel tank drops below 1/4 tank, the system will automatically shut off. This 1/4 tank reserve is so you can travel to refuel.
2. If your stay is longer than overnight, you should endeavor to have a shoreline hookup.
3. Minimize use of electricity if 120-volt power source is not available.
4. Leave cabinet doors, wet bath doors, and wardrobe doors slightly open at night to allow circulation of air in and around all components.
5. Save power by using non-toxic RV- approved antifreeze in the gray water holding tank instead of the heating pad to prevent freezing. Quantity of antifreeze needed will vary with ambient temperature and the amount of liquids in tank.
6. For extended stays in cold weather, insulate all water lines outside the touring coach. You should remember that low temperatures in combination with high winds cause an equivalent chill temperature much below what your thermometer is reading. For instance, with an outside temperature of zero degrees, and the wind velocity of 10 miles per hour, the equivalent chill temperature is -20°F.
7. Remember to remove and drain the exterior shower faucet to prevent freeze damage.

Heated Tanks

The touring coach has 12-volt heat pads installed with the fresh and gray water tanks to help prevent freezing. The tank heaters are controlled using the Multiplex system; [see Multiplex System on page 5-18](#). When the outside temperature is near freezing, simply switch “ON” the tank heaters. Built-in sensors will activate the heat pads when the contents of the tanks drop to 44°F. Once the liquid is heated and rises to 64°F the heat pads will automatically deactivate. Switch the power “OFF” when the ambient outside temperature remains above freezing or if the tanks are empty. The tank heaters will eventually deplete the house battery unless the unit is plugged into an external power source. To conserve battery power, RV antifreeze may be used to protect the gray and waste tanks.

NOTE

The waste tank is installed above the floor where heat from the furnace will keep it from freezing.

NOTICE

Drain and winterize all models if the water systems are not being used during winter traveling; [see Winterizing and Storage on page 9-8](#).

AIRSTREAM®

Section 4 FLOOR PLANS AND SPECIFICATIONS

FLOOR PLAN	4-2
Interstate 19X	4-2
SPECIFICATIONS	4-3
Interstate 19X Specifications	4-3
Specifications Definitions	4-4
Specifications Labels	4-4
Occupant and Cargo Carrying Capacity Label	4-4
Tire and Loading Placard	4-4
Manufacturer's Certification Label	4-4

Floor Plans And Specifications

Floor Plan

Interstate 19X



Specifications

Interstate 19X Specifications	
Chassis	Mercedes-Benz® Sprinter 2500
Engine	Mercedes-Benz® 2.0L Turbo Charged High Output 4-Cylinder Diesel
Horsepower/Torque	208HP/332 lb-ft Torque
Transmission	9G-Tronic, 9 Speed Automatic Transmission
Emissions	BlueTEC SCR Technology, 50 State – EPA/CARB Standards
Axle Ratio	3.92
Wheelbase	144"
MPG ^[1]	16-18+ Estimated Highway
Exterior Overall Length	20' 1"
Exterior Overall Height with A/C and Antenna	9' 9"
Exterior Overall Width w/Mirrors	7' 8.5"
Interior Height	6' 2.5"
Interior Width	5' 10"
GVWR ^[2]	9,050 lbs
GCWR ^[2]	13,930 lbs
UVW/UBW ^[2]	Weights are listed on the OCCC Label and Tire and Loading Placard; for more information, see Specifications Labels on page 4-4
OCCC ^[2]	
Tow Capacity/Tongue Weight ^[3]	Up To 5,000 lbs/500 lb Tongue Weight
Fuel Tank	24.5 gallon
Fresh Water Tank	20 gallon
Gray Water Tank	16 gallon
Waste Water Tank	9 gallon
Furnace/Hot Water	Truma Combi D Comfort Plus, On-demand Diesel/Electric
Air conditioner	13,500 BTU
Refrigerator w/Freezer Box	3.1 CU FT Refrigerator, .33 CU FT Freezer 12V
Microwave	.7 cubic feet
Cooktop	1,000 Watt, Single burner, Induction
House Batteries, Advanced Power	3 – 12 Volt 270 Ah LiFePO4 batteries w/Built-in Heater (10.3kWh)
Inverter/Converter	3,000 Watt Pure Sine Inverter/130A Multi-Stage Charger
Shore Power	30-Amp/120-Volt Service
Solar Power	240 Watts
Front and Rear Parking Sensors	Standard
Bed Size	74" x 70"
Wheel Fastener Torque Value ^[4]	133 ft-lbs
Tire Size / Max Cold Inflation Pressure ^{[2][5]}	Tire size and max cold inflation pressure are listed on the Tire and Loading Placard on the B-pillar (driver's door jamb); For more information, see Tire and Loading Placard on page 4-4
Airstream Limited Warranty	2 Years
Mercedes-Benz® Chassis Warranty	5 Years/75,000 Miles
Mercedes-Benz® Engine & Drive Train Warranty	5 Years/100,000 Miles

1. Actual mileage will vary based on load carrying, driving style, and road conditions.

2. For more information, see [Specifications Definitions on page 4-4](#) and see [Specifications Labels on page 4-4](#).

3. Tow capacity will vary with build spec and intended vehicle loading with people, cargo, and fluids.

4. For safety reasons, wheel fastener torque must be checked immediately after reinstalling wheels and again after 30 miles.

5. In this context, cold refers to how long a tire has sat idle. *Max cold inflation pressure* should be checked in the morning (after sitting idle for at least three hours) before driving more than one mile or before rising ambient temperatures and the sun's radiant heat can affect tire pressure.

Floor Plans And Specifications

Specifications Definitions

Unloaded Vehicle Weight (UVW) or Unit Base Weight (UBW) is the factory manufactured/empty weight of the touring coach. UVW includes fuel, engine operating fluids, and all batteries; *UVW is listed as “factory manufactured weight” on the Tire and Loading Placard.*

Gross Combined Vehicle Weight Rating (GCWR) is the maximum weight rating of the vehicle with a trailer attached; *GCWR is listed on the previous page.*

Gross Axle Weight Rating (GAWR) is the value specified as the load carrying capacity of a single axle system, as measured at the tire-ground interfaces. This is the maximum amount of weight that can be placed on each axle; *GAWR is listed on the Manufacturer’s Certification Label.*

Gross Vehicular Weight Rating (GVWR) is the maximum permissible weight of the Touring Coach when fully loaded; *GVWR is listed on the Tire and Loading Placard and Manufacturer’s Certification Label. It is also listed on the previous page.*

Occupant and Cargo Carrying Capacity (OCCC) is the maximum total weight of all occupants, cargo, fresh water, and any tongue weight of a towed trailer; *OCCC is listed on the OCCC label and Tire and Loading Placard.*

GVWR - UVW = OCCC

⚠ WARNING

The combined weight of occupants and cargo should never exceed the limit on OCCC label.

⚠ WARNING

Wheel fastener torque must be checked immediately after reinstalling a wheel and again after 30 miles. Torque all wheel fasteners evenly to specification using the proper sequence; see [Wheel Bolt/Lug Nut Tightening on page 7-8](#). For torque values, see [Specifications on page 4-3](#).

NOTE

All product information and specifications listed are as accurate as possible at the time of printing. Since we continually strive to improve our products, all specifications are subject to change without notice.

NOTE

Specifications labels shown are examples only.

Specifications Labels

Occupant and Cargo Carrying Capacity Label

MOTOR HOME OCCUPANT CARGO CARRYING CAPACITY
VIN: XXXXXXXXXXXXXXX
THE COMBINED WEIGHT OF OCCUPANTS AND CARGO SHOULD NEVER EXCEED
XXX kg OR XXX LBS
 Safety belts equipped seating capacity: X
CAUTION:
 A full load of water equals XX kg or XXX lbs of cargo @ 1kg/L (8.3lb/gal) and the tongue weight of a towed trailer counts as cargo.
 Motor Home overall length XXX (XXX cm) as manufactured

The Occupant and Cargo Carrying Capacity Label on the edge of the passenger door lists the VIN, OCCC, safety belt equipped seating capacity, the weight of a full load of water, and the motorhome’s overall length.

Tire and Loading Placard

TIRE AND LOADING INFORMATION
RENSEIGNEMENTS SUR LES PNEUS ET LE CHARGEMENT

The combined weight of occupants and cargo should never exceed XXX kg or XXXX lbs.

SEATING CAPACITY TOTAL X FRONT X REAR X

TIRE PNEU	SIZE DIMENSIONS	COLD TIRE PRESSURE PRESSION DES PNEUS A FROID	SEE OWNERS MANUAL FOR ADDITIONAL INFORMATION VOIR LE MANUEL DE L'USAGER POUR PLUS DE RENSEIGNEMENTS
FRONT AVANT	XXXXXXXXXX	XXX kpa (XX Psi)	
REAR ARRIERE	XXXXXXXXXX	XXX kpa (XX Psi)	
SPARE DE SECOURS	XXXXXXXXXX	XXX kpa (XX Psi)	

The factory manufactured weight of this motor home is XXXX kgs XXXX (lbs).
 The GVWR of this motor home is XXXX kgs XXXX (lbs).

The Tire and Loading Placard on the B-pillar (driver’s door jamb) lists OCCC, UVW, GVWR, seating capacity, tire size, tire cold inflation pressure, and the last six digits of the serial number.

Manufacturer’s Certification Label

MANUFACTURED BY : AIRSTREAM, INC

GVWR: XXXX kg/ XXXX lb		DATE: XXXXXXXX XXX	
GAWR	TIRES	RIMS	COLD INFL.PRESS.
FRONT	XXXXXXXXXX	XXXX	XXX KPA SINGLE <input checked="" type="checkbox"/>
XXXX KG/ XXX LB			XX PSI DUAL <input type="checkbox"/>
INTERM			SINGLE <input type="checkbox"/>
			PSI DUAL <input type="checkbox"/>
REAR	XXXXXXXXXX	XXXX	XXX KPA SINGLE <input checked="" type="checkbox"/>
XXXX KG/ XXX LB			XX PSI DUAL <input type="checkbox"/>

THIS VEHICLE CONFORMS TO ALL APPLICABLE U.S. FEDERAL MOTOR VEHICLE SAFETY STANDARDS IN EFFECT ON THE DATE OF MANUFACTURE SHOWN ABOVE ALL WEIGHTS ARE APPROXIMATE

V.I.N./N.I.V.:XXXXXXXXXXXXXXXXXX TYPE/TYPE: XXXXXXXX MODEL: XXXXXX
 XXXXXXXXXXXXXXXXXXXX XX XXX Serial: XXXXXXXXXXXXXXXXXXXX

The Manufacturer’s Certification Label on the driver’s seat pedestal lists the GVWR, GAWR, date of manufacture, tire size, rim size, tire cold inflation pressure, VIN/NIV number, vehicle type, model, and the full serial number.

AIRSTREAM®

Section 5 INTERIOR

GENERAL INFORMATION AND CLEANING	5-3	ELECTRICAL SYSTEM OVERVIEW	5-8
Upholstery	5-3	Power Center	5-8
Aluminum Interior Skin	5-3	Circuit Breaker Protection	5-8
Vinyl Flooring	5-4	Ground Fault Circuit Interrupter (GFCI)	5-9
General Cleaning	5-4	GFCI Breaker Test	5-9
Interior Doormat and Rug Selection	5-4	Auxiliary Fuse Locations.	5-9
Privacy Sun Shades	5-4	120 volt System	5-10
Window Shades	5-4	City Power Overview	5-10
Countertops	5-4	Outlets and USB Ports	5-10
Sink and Faucet Care	5-5	12 volt System	5-10
Wet Bath	5-5	Overview.	5-10
Shower Head	5-5	Undercarriage Electrical Components	5-11
Retractable Clothesline	5-5	Solar System.	5-11
Toilet	5-5	ELECTRICAL SYSTEM OPERATION.	5-11
Deodorizers and Biological Chemicals	5-5	Battery Disconnect Switches	5-11
Driver and Passenger Seats	5-6	Battery Power Pushbutton	5-11
Storage	5-6	Manual Battery Disconnect Switch.	5-12
Cabinets, Roof Lockers, and Cubbies	5-6	Energy Management System (EMS)	5-12
Under-Seat Storage and Bedframe		Inverter/Charger	5-13
Wall Tethers	5-6	12V Power Loss/Backup Converter	5-13
L-Track Cargo Rail Storage	5-6	House Battery Pack	5-14
Bed Conversion	5-7	Battery Management System (BMS)	5-14
Table System	5-8	High Voltage Disconnect	5-14
		Low-Voltage Disconnect.	5-15
		Temperature Limits.	5-15
		Battery Heaters	5-15

Section 5 Interior

Battery Management and Charging5-16	APPLIANCES5-21
Battery Monitoring/State of Charge (SOC)	.5-16	Maintenance5-21
Charging via Shoreline Connection5-16	Air Conditioner5-21
DC-DC Charger, REDARC Alpha5-17	Cooktop5-21
Charging via Solar Power5-17	Ceiling Vent Fan5-22
Charging via Secondary Alternator.5-17	Operation5-22
Multiplex System5-18	Rain Sensor5-22
Cleaning the Multiplex Touchscreens.5-18	Cleaning Instructions5-22
Multiplex Bluetooth® App5-19	Exhaust Vent5-22
Lighting5-19	Operation5-22
Ceiling and Directional Lights.5-19	Furnace and Water Heater5-23
Docking Light5-19	Overview.5-23
ENTERTAINMENT SYSTEMS5-20	Troubleshooting5-23
Wireless Bluetooth Speaker5-20	Truma Combi Control Panel5-24
TV Pre-wire and TV/Radio Antenna5-20	Safe Operation5-24
Antenna Pre-Wiring5-20	Exhaust and Condensation Spout5-24
Cable/Satellite Connection5-20	Hot Water Tempering Valve5-25
Starlink Pre-Wire5-20	Water Heater Pressure Relief/Drain Valve	.5-25
Airstream Connected RV Antenna Pre-		Microwave.5-25
Wire5-20	Refrigerator5-25
		Operation5-25
		Defrost and Cleaning5-25

General Information and Cleaning

The interior of every Airstream is crafted with features that offer comfort, convenience, functionality, durability, and design appeal. Our goal in this section is to deliver the best experience possible by providing you with the knowledge you need to enjoy these features and care for them to ensure their longevity.



Airstream Supply Company is your trusted source to obtain care products and supplies to help maintain and enjoy your Airstream. Scan this QR code to visit and explore our recommended assortment of RV care products and much more at airstreamsupplycompany.com.

Many of the appliances and components installed in your Airstream come with manuals from the manufacturers that produced them. These manuals provide detailed instructions and critical safety alerts that should be read and followed before operating them. If any manual(s) have not been provided in your owner's packet, contact your dealer, appliance or component manufacturer, or Airstream Customer Service at 937-596-6111 or email: support@airstream.com

Upholstery

The front driver and passenger seats consist of two fabrics. Each seat's main body and headrest are covered in Ultraleather, and the stitched portion is Vinyl with a Permablok[®] protective coating.

The bench-style seat cushions and backrests consist of two fabrics as well. The cushions are covered in the same Permablok protective-coated Vinyl found in the stitched portion of the front and bench seat backrests. See cleaning instructions for each fabric below.

Spot clean Ultraleather regularly with mild soap and water. For stubborn stains, wipe with isopropyl (rubbing alcohol) as soon as possible. Sanitize using a disinfectant such as a 5:1 water/bleach solution. Air dry or dry quickly with a hair dryer on low.

PermaBlok[®] is a vinyl protective coating engineered to create a tough, effective barrier against the three biggest problems: germs, abrasion, and stains. Most stains can be removed with a damp cloth and cleaned with a 1:1 mix of Ivory[®] soap and water. A 1:1 mix of ammonia and water or a 1:4 mix of bleach and water can be used for more stubborn stains. Only if needed a 1:1 mix of isopropyl alcohol and water can be used. Use only a soft cotton cloth and rub the stain in a circular motion. Rinse thoroughly with clean water and pat dry.

NOTICE

Never remove cushion covers for separate dry cleaning or washing. Any tumble cleaning method can destroy the backing, and/or shrink or otherwise damage upholstery fabric.

Aluminum Interior Skin

The metal interior skin on the ceiling is coated with a baked-on acrylic coating. Use soft rags or wash mitts always moving lengthwise with the grain of the aluminum. NEVER rub hard on the coating. Oil, grease, dust, and dirt may be removed by washing with a 5 percent solution of commonly used commercial and industrial multi-purpose detergent in water. Cleaning should be followed by a thorough clean water rinse. Drying the metal with a chamois or a soft cloth may prevent spots and streaks. When washing or waxing the metal, always wipe "with" the grain of the metal. A good grade of nonabrasive automotive paste or liquid wax once a year will increase the life of the finish.

NOTICE

Abrasive polishes or cleaning solvents such as automatic dishwasher or acid etch cleaners are too strong and should never be used. Rinse all grit from surface prior to washing. Use soft rags always moving lengthwise with the unit. NEVER rub with excessive pressure on the coating. Even the softest rag will damage the coating if excessive pressure is applied.

Vinyl Flooring

General Cleaning

Use a soft broom to sweep the floor. A vacuum cleaner may damage the flooring, especially the type that use beater bars. In most cases, a clean damp cloth or mop will suffice to clean dirty flooring. When necessary, a solution of mild detergent or domestic floor cleaning emulsion can be used to clean the flooring. Do not use a wire brush or nylon scouring pads, furniture polish, spirit-based polish, powder or liquid abrasive cleaners, bleach or other strong detergents. Scuffs, dirt, and spillages should be cleaned up as soon as possible.

For spirit-based products such as shoe polish, solvents, hair dye, and permanent marker pens, wipe up spots and marks as quickly as possible. This also applies to mustard and strongly colored foodstuffs. Corrosive substances such as acid and alkaline solutions can damage the surface of the floor. Clean up any spills quickly and carefully avoiding direct contact with the substance. Wear protective clothing such as gloves when doing so. Bitumen/tar from freshly resurfaced or melted roads and pathways, and some inexpensive rubber shoe and slipper soles can cause stains. The above materials are likely to cause damage but are not considered restrictive.

NOTICE

The use of certain cleaning agents, including but not limited to powdered abrasives, solvents, and industrial strength cleaners is not recommended.

Interior Doormat and Rug Selection

To avoid staining or discoloration of vinyl flooring, only use doormats or rugs made of natural fibers.

NOTICE

Rubber or latex-backed mats or furniture with rubber feet may stain or discolor vinyl flooring.

Privacy Sun Shades

Privacy shades are provided for the front windshield and driver/passenger cab windows. The shades have magnets sewn into them that attach to the van.

Light brushing with an upholstery brush or gentle use of a vacuum cleaner will suffice in most situations. For heavy soiled conditions dry clean only. Washing the shades may void the warranty.

Window Shades



Window shades are provided for the side windows and attach to the van by Velcro along the windows trim. Velcro along the inner edges of the shades allow them to be folded up, gaining access to vent the windows. The shades can be left attached or be completely removed and stored.

To clean, brush off dirt before it becomes embedded and wipe up spills soon after a stain occurs. Use a mild cleaning solution of soap and water.

Countertops

The countertops can be cleaned with soap and water or use a common solvent on tough spots. Do not use abrasive cleaners since they can scratch the surface. A protective pad should always be used under hot utensils or pans.

NOTICE

Do not use abrasive cleaners or scouring pads; they could scratch the surface. Use a protective pad for hot items.

Sink and Faucet Care

To clean sinks and faucets, dampen a soft cloth with warm water and a small amount of mild liquid soap or detergent. Gently wipe down all surfaces, then rinse with clean water and dry with a soft cloth. Avoid abrasive scrubbing sponges, steel wool, scouring powders, and harsh chemical cleaners, as these can damage or dull the protective finishes on sinks and faucets. Using gentle cleaning methods helps preserve the appearance and integrity of the materials. For best results, wipe down sinks and faucets after each use to prevent water spots, soap residue, and grime from accumulating.

Avoid leaving cookware in the sink, especially metal like cast iron, as it can cause stains and scratches. Depending on the sink and faucet manufacturer, additional care instructions may be included in your owner's packet.

Wet Bath

Wet the bath surface and clean it using a non-abrasive sponge or soft cloth and a non-abrasive liquid detergent cleaner safe for acrylic, gel coat, and fiberglass bath surfaces. Avoid using acidic or harsh commercial bath cleaners. Rinse and dry with a soft towel. A wax or sealer suitable for these surfaces can be applied to the stall to restore gloss to dull areas when necessary, but should not be used on the shower floor as this could create an unsafe, slippery surface.

WARNING

Applying wax to the shower floor is not recommended and could create an unsafe, slippery surface.

Shower Head

The shower head facilitates water-saving when camping without a fresh water hookup. To conserve water while showering with fresh tank water, turn the water off between lathering and rinsing.

Retractable Clothesline

A retractable clothesline is installed for your convenience in the shower stall. To use, pull the line from the base and attach it to the holder on the opposite wall. Turning the nut on the base will tighten the line.

Toilet

The toilet in your Airstream is a design that has been used for many years.

To flush, press the foot pedal, holding the pedal down until all solids have cleared. To add water into the bowl, press the pedal down halfway.

NOTICE

When you dump the bowl of the toilet, make sure all paper and solids have cleared the slide mechanism before you allow it to close. Failure to do so can cause the groove for the slide to become jammed and the slide will no longer close completely.

Please see the toilet owner's/user manual for warranty, user tips, and maintenance information.

Deodorizers and Biological Chemicals

There are many deodorizers and processing chemicals on the market in tablet, liquid, and powder form. These not only combat odor, but also stimulate the bacteria that works to dissolve the solids and tissues in your waste tank. These chemicals should be introduced through the toilet prior to use per the manufacturers directions. It's also important to always add a few gallons of water by filling the toilet bowl a few times and depressing the foot pedal

Driver and Passenger Seats

Mercedes Sprinter provides the driver and passenger seats, which Airstream recovers to match the interior decor.

Sprinter's seat adjustment mechanism allows the seat to be moved forward or backward and swivel left or right. Buttons near the door handle move the seat forward and backward. Pressing down on the handle, centered under the front of the seats, allows the seat to swivel. Return the seat to the full upright position before using the swivel adjustment. The heated seats are activated by switches on the door next to the seat controls. For complete details on seat adjustments, please refer to the Sprinter manual.

⚠ WARNING

Adjust the driver's seat so that you can easily reach and operate all controls. Make sure the seat is locked in position. Do not adjust driver's seat swivel or fore and aft mechanism while vehicle is moving. The seat could move unexpectedly causing loss of control.

NOTICE

Seat backs in cab must be returned to full upright position and seat moved forward before seat is swiveled. Failure to do so could result in damage to the seats upholstery, the wall panels, and the seats decorative skirt.

Storage

Cabinets, Roof Lockers, and Cubbies

Latching hardware keeps doors and drawers secure while traveling. To open doors and drawers equipped with secure latching hardware, press the spring-loaded knob inward until it pops out to use as a pull. When closing, push the knob back into the recess until the mechanism latches.

Exercise caution when storing items in cubby spaces and other open storage areas as they could dislodge during travel. Heavy items could cause damage and even be dangerous should they dislodge while making sudden stops. Always secure cargo before travel. It is recommended to store heavier items in lower storage areas and lighter items overhead.

⚠ WARNING

Unsecured cargo can cause injury or lead to a vehicle accident and may damage the coach's interior should it become dislodged.

⚠ WARNING

Keep flammable material away from appliances with burners and do not block vents.

NOTICE

The cab storage shelf has a 40 LB weight limit; all other storage shelves have a 50 LB limit.

Under-Seat Storage and Bedframe Wall Tethers

For hands-free access to under-seat storage, the cushions can be removed, and the hinged bedframes can be raised and secured to the wall-mounted L-track anchor points using the attached straps and quick-release attachments.

To remove cushions, grasp them at the front edge and lift them from front to back to detach them from the velcro. If a wood slat gets disconnected from the frame when removing a cushion, it's easier and safer to reinsert it with one of its plastic end caps removed from the frame. You can remove an end cap by pulling it upward to pop it out of the frame.

L-Track Cargo Rail Storage



Your coach has L-track rails (airline-style cargo track) on the floor, ceiling, and walls. This high-grade aluminum track is durable and lightweight and creates strong and secure tie-down anchor points when equipped with L-track fittings.

 A wide range of fittings and accessories can be purchased and installed aftermarket. Visit <https://airstreamsupplycompany.com> by scanning this QR code to view some available accessories. Enter L-track in the search field to find attachments like the L-track quick-release latch or the L-track bike mounting system.

Bed Conversion

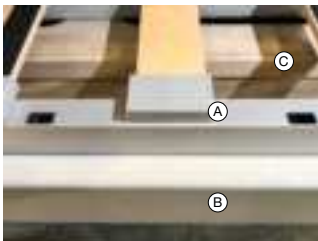

The following is a list of the bed components in the order of top-to-bottom location in the touring coach (diagram above), followed by assembly instructions.

- A. Curbside and roadside retractable wood-slat bedframes.
- B. Curbside only pull-out bed support.
- C. Curbside and roadside wooden seat bases.

Not shown: additional bedframe pieces (small sections of frame stored under the roadside bench seat).

The bed can be assembled without removing the cushions but they can be removed if preferred. For cushion removal instructions and how to raise the bedframes for under-seat storage access, see [Under-Seat Storage and Bedframe Wall Tethers on page 5-6](#).

Seat to Bed Conversion, Curbside:

1. Retrieve the additional bedframe pieces from under the roadside seat base.
2. Locate and unstrap the slide lock strap on the center edge of **curbside bedframe (A)**.

3. Grasp both handles and pull **bed support (B)** along with **curbside bedframe (A)** out until the assembly latches in the extended position.
4. If the backrest cushions do not fall flat, gently push them down into position.

Seat to Bed Conversion, Roadside:

1. Locate and unstrap the slide lock strap on the center edge of **roadside bedframe (A)**.
2. Extend **roadside bedframe (A)** and align its bracket hooks with the holes in **curbside bedframe (A)**; hook the two halves together.
3. Move the smaller end cushions out of the way and insert the additional bedframe pieces retrieved from under the roadside seat:
 - Align the piece *with* pins to the holes in **bed support (B)** and lower it in to place.
 - Hook the piece *without* pins into place to complete the frame assembly.
 - Lay the small cushion pieces flat to finish out the bed assembly.

Bed to Seat Conversion, Roadside:

1. Pull the backrest cushions up and onto the seat.
2. Remove the small cushions and bedframe pieces.
3. Stow **roadside bedframe (A)** and the small bedframe pieces; secure the bedframe by buttoning the slide lock strap.

Bed to Seat Conversion, Curbside:

1. Pull the backrest cushions up and onto the seat.
2. Reach under the front of **bed support (B)**, locate, and push up on the yellow levers on each of the two slides to release the locking mechanisms and push the assembly into the stowed position; secure the bedframe by buttoning the slide lock strap.

⚠ CAUTION

Do not extend and use the roadside bedframe by itself. It will not support a person's weight. The curbside bed can be extended, latched, and used solo but has a weight limit of 300 lbs. max. The fully assembled bed limit is 600 lbs. max.

⚠ CAUTION

Exercise caution to avoid pinch points when assembling, disassembling, and using the bench seats and bed.

Table System



The touring coach is equipped with a removable table which is stored behind the driver's seat. To remove from the mount, move the driver's seat forward for clearance. Loosen the knob at the top of the table and rotate the bracket. Pull the table out, careful not to damage the table or the paneling. Turn the table over and remove the leg by loosening the handle and sliding off the table. Insert the table leg into the desired leg holder and adjust it to the desired height. Install the table top onto the leg and tighten it to the desired position.

⚠ WARNING

Return the table to the proper storage position before moving the vehicle. In an emergency stop or accident, the table could cause personal injury and death if not properly stowed

Electrical System Overview

Power Center



The Power Center is a self-contained 120-volt AC (120V AC) power distribution center used in recreational vehicles. It houses the coach's circuit breakers and fuses. Its primary function is to provide circuit protection for all 120V AC loads in the touring coach and is central to the overall electrical system. It distributes 120V AC power to the appliances and also supplies 120V AC to the converter, which transforms 120V AC to 12V DC to power the 12V DC systems.

The Power Center distributes incoming power from two sources: Shoreline power when connected to an external 120V AC power supply (city power) and the Advanced Power System (lithium-ion battery pack) via the 12V DC to 120V AC inverter.

The Power Center is located at the base of the roadside bench seat. Open the decorative door to access 12V fuses and 120 VAC breakers.

⚠ WARNING

The power center is a centralized power switching, fusing, and distribution center. The potential of lethal electrical shock is present in this box. Inadvertent shorts at this box could result in damage and/or injury. All servicing of this box should be done by a qualified Service Technician.

Circuit Breaker Protection

Standard residential-style (resettable) circuit breakers provide circuit protection for all 120V AC loads. Airstream has installed breakers per RVIA (NEC) listing requirements for the touring coach.

The 30 amp main breaker feeds individual branch breakers. The branch-breakers protect individual loads, which are identifiable by the affixed labels. Shutting off the main breaker will remove power to all branch loads (except for outlets/receptacles on the inverter circuit when the inverter is enabled, see GFCI below).

A circuit breaker's ON/OFF switch function operates like a light switch: up is ON, and down is OFF. If an overload or short occurs, the breaker will snap to the OFF position to protect the connected circuit. As a result, any device running on the circuit will lose power. Before attempting to reset the breaker, consider the cause. If a connected device is faulty or uses a higher amperage than the circuit breaker's capacity, turn it off before resetting the breaker.

Before resetting the breaker, you need external AC power going to the breaker box. Firmly push the breaker switch to the OFF position and back to the ON position. If the breaker snaps back to the OFF position while resetting, a fault condition still exists and should be serviced by a qualified Service Technician. Suppose the breaker stays ON but snaps back OFF after turning on a possibly faulty appliance. In that case, a fault condition may exist in that appliance that will require service by a qualified Technician.

Ground Fault Circuit Interrupter (GFCI)

Some outlets/receptacles on your Touring Coach are GFCI protected. The GFCI breaker provides reliable overload and short-circuit protection. GFCI breakers protect against ground faults and provide additional safety to the occupants of the touring coach on all outlets/receptacles. A ground fault occurs when current travels along an unintended path to ground, possibly through water or a person, which may result in an electric shock. The GFCI compares the amount of current going to and returning from the device plugged into the circuit's outlet/receptacle. When the amount of current going to the device differs from the amount returning, the GFCI interrupts the current within a fraction of a second, removing power from the circuit, and protecting the user.

Each GFCI circuit breaker is calibrated to trip with a ground current of 5 mA or more. Since most people can feel as little as 2 mA, a shock may be felt. The shock should be of such a short duration that the effects would be reduced, less than what would normally be a dangerous level. However, persons with acute heart problems or other conditions that can make a person particularly susceptible to electric shock may still be seriously injured.

While the GFCI circuit breaker affords a high degree of protection, there is no substitute for knowing that electricity can be dangerous when carelessly handled or used without reasonable caution.

The system incorporates GFCI breakers that implement an auto-self-test functionality. When turned off, these breakers require external AC power to be present before they can be turned back on. If power is present, and the breaker refuses to stay on, consult an electrician or certified RV technician.

⚠ WARNING

The GFCI circuit breaker will NOT reduce shock hazard if contact is made between a HOT load wire and a neutral wire or two HOT load wires. GFCI circuit breakers provide protection only to the circuit to which it is connected. It does NOT protect any other circuit.

GFCI Breaker Test

Perform this test on the GFCI circuit breaker each month and record the date.

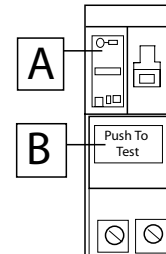

1. With handle A in the "ON" position, press PUSH TO TEST button B.
2. Handle A should move to the TRIP position, indicating that the GFCI breaker has opened the circuit.
3. Move handle A to the "OFF" position and back to the "ON" position to restore power.

If the device remains on when the Test button is pushed, the GFCI is not working properly or has been incorrectly installed (wired improperly). If your GFCI is not working properly, call a qualified, certified electrician who can assess the situation, rewire the GFCI if necessary, or replace the unit.

Auxiliary Fuse Locations

In addition to the 12-volt fuses and breakers located in the power center, several components of the coach are protected by in-line fuses. These are usually located at or near the components they protect. There are also several fuses located under the driver and passenger seats. For additional information, see [12-Volt Main Schematic on page 9-13](#).

NOTICE

Most fuses will require a qualified technician to access and replace. Contact your dealer or Airstream Service Center.

120 volt System

City Power Overview

120-volt AC shoreline power (city power) enters the coach through the SmartPlug cordset connection and is routed to the power distribution center and inverter/charger. The inverter/charger serves as a pass-through when connected to shore power, supplying 120V AC power to major appliances such as the electric element of the heating and hot water system, air conditioner, cooktop, microwave, and receptacles.

In addition to its pass-through function, the inverter plays a key role when off-grid (boondocking) by converting stored 12V DC battery power into 120V AC power, allowing appliances and outlets to function without shore power. However, the available power is dependent on battery capacity and charge level.

The Energy Management System (EMS) actively monitors power usage and automatically sheds loads when necessary to help prevent circuit overloads and breaker trips; [see Energy Management System \(EMS\) on page 5-12](#).

If an outlet or appliance is not working:

- Check the circuit breakers in your touring coach and at the shoreline connection.
- If a breaker trips repeatedly after being reset, the circuit may be overloaded or have a short.
- Reduce the number of devices running simultaneously to lessen the load on the circuit.
- If the issue persists, contact an Airstream Service Center for assistance.

Outlets and USB Ports

Several 120V receptacles and USB charging ports are located throughout your touring coach's interior. The outlet on the front of the curbside galley (just below the countertop) is controlled by the EMS and was designed with cooktop use in mind. It is the only outlet the cooktop should be plugged into.

NOTICE

The outlet on the front of the curbside galley is controlled by the EMS (see below) and was designed with cooktop use in mind and is the only outlet the cooktop should be plugged into. Depending on the use of other 120 VAC appliances and outlets, temporary interruptions in service may occur.

12 volt System

Overview

Your touring coach is equipped with a robust house battery system designed for extended off-grid use and reliable power management. With its high capacity, the system supports both everyday power needs and longer off-grid stays. For detailed information on your specific setup; [see House Battery Pack on page 5-14](#).

Supporting the battery system is the Xantrex Freedom XC Pro 3000 inverter/charger, delivering 3,000 watts of continuous pure sine wave power, 6,000-watt surge capacity, and a 150A battery charger for efficient lithium battery charging; [see Inverter/Charger on page 5-13](#). Also supporting the battery system is a secondary alternator and regulator, which supplements the vehicle's primary alternator by providing high-output charging to rapidly replenish the battery bank while driving; [see Charging via Secondary Alternator on page 5-17](#). Additionally, solar panels contribute to battery maintenance, reducing reliance on other charging sources.

State of Charge (SOC) is the primary concern when using only battery power from the onboard battery pack. With the exception of 120V AC appliances and outlets, everything runs on 12V DC power (some appliances still require 12V DC power to operate).

Power is routed from the house battery pack to the 12V DC distribution panel and through its branch circuits to the rest of the touring coach. All 12V DC current is routed to a 12V DC fuse block, which then distributes power to a busbar holding Type 2 thermal breakers. These breakers supply power to various electrical components throughout the touring coach.

⚠ CAUTION

Type 2 thermal breakers automatically reset once they cool down after tripping due to overheating from an overload or short circuit. If a breaker repeatedly overheats and trips, it should be inspected by a qualified service technician to diagnose the underlying issue.

NOTE

The engine battery and house battery are isolated from each other, preventing the two systems from drawing down simultaneously.

Undercarriage Electrical Components

Some features of the electrical system, including the battery pack, are mounted to the undercarriage. While these areas are protected from normal road debris and water infiltration from normal operation, they are not submersible.

NOTICE
<p>It is imperative that you do not allow any part of your touring coach to be submerged in water as it could cause damage to electrical components that a warranty would not cover.</p>

Solar System

The rooftop solar panels on your Airstream help maintain the charge and extend the life of both the house and chassis batteries. To maximize solar charging efficiency, keep the panels clean and free from shade caused by trees or structures that might obstruct sunlight. For more information on solar power, see [DC-DC Charger, REDARC Alpha](#) on page 5-17 and see [Solar Ports](#) on page 6-9.

Electrical System Operation

⚠ WARNING
<p>This manual provides an overview of the electrical system, its components, and basic operation. For detailed instructions, refer to the electrical component manufacturers' manuals in your Airstream Owner's Packet. It is important to review all manufacturer instructions and safety notifications before using the system.</p>

Battery Disconnect Switches

Battery Power Pushbutton



The Battery Power pushbutton, located inside the entry door on the side of the roof locker, is used to separate the 12-volt distribution panel from the charging system. When the button is pressed, it activates the motorized function of the Manual Battery Disconnect Switch causing it to rotate to the ON position.

The house and chassis batteries will continue to charge from shore power, the alternator, and solar panels even if the battery disconnect switch is turned OFF. However, when not connected to an external power source, turning the switch OFF disconnects the house batteries, cutting off all 12-volt power, except the battery heaters, which can still be manually activated with the dedicated key switch; see [Battery Heaters](#) on page 5-15. It is recommended to turn the battery disconnect switch OFF during long-term storage or when conserving battery power while the coach is not in use.

Manual Battery Disconnect Switch



The motorized manual disconnect switch is located behind the left rear door and does not require user input for day-to-day use. The auto rotating function is activated by pressing the battery power pushbutton at the main entrance.

The knob can be manually rotated past the auto OFF setting to the manual OFF position by pressing inward on the knob and rotating. Likewise, the knob can be manually rotated past the auto ON setting to the manual ON position.

NOTICE

Rotating the disconnect switch manually without pushing in can result in damage to the switch. Do not over rotate the switch. Over rotating can damage the switch rendering it inoperable, resulting in power loss.

The manual OFF feature is useful when storing the coach. With the knob set to manual OFF, the pushbutton is disabled and cannot be turned on inadvertently, leading to a dead battery.

Likewise, the manual ON feature is useful while camping. With the knob set to manual ON, the pushbutton is disabled and cannot be inadvertently turned off, cutting power to appliances like the refrigerator.

The holding tank heat pads and solar panel are not connected to the 12-volt distribution panel and are wired direct in through the thermal breakers. The main disconnect will not disable these systems.

Energy Management System (EMS)



The Energy Management System (EMS) monitors and regulates 120-volt power usage, automatically managing appliances to prevent circuit overloads. It ensures that total current draw stays within the user-selected shore power service limit, reducing the risk of tripped breakers.

The control display is inside the roof locker above the galley. By default, the system starts in 30A mode when power is supplied. Pressing SELECT allows the user to cycle between service modes to match available shore power. For example, a standard home outlet typically provides 15-20A service, requiring the user to select the corresponding mode. Campgrounds often provide full 30A service, allowing the system to operate at maximum capacity. Pressing SCROLL cycles through system information, including total power usage, available service type, and currently shed appliances.

When 120V AC and 12V DC power are supplied, the system gradually energizes each EMS load control relay, allowing power to flow to connected appliances while monitoring total power consumption. If usage exceeds the service limit, the EMS will automatically shed (remove power from) appliances in the following order:

- 1 Electric heating element (heating/hot water system)
- 2 Air conditioner
- 3 Cooktop
- 4 Microwave

As each load is shed, the system calculates and stores the reduction in power demand, learning the power draw of each appliance and adjusting for voltage and temperature variations to improve accuracy.

Once power consumption drops below the limit and remains stable for at least two minutes, the EMS will automatically restore power to the shed appliances in reverse order (microwave first, then cooktop, etc.).

Inverter/Charger



Your touring coach is equipped with a Xantrex Freedom XC Pro 3000-watt inverter/charger and a remote control display (shown above). This system delivers 3,000 watts of continuous pure sine wave power, a 6,000-watt surge capacity, and a 130A battery charger for efficient lithium battery charging. The display, in the galley roof locker near the entrance, provides real-time status updates, allows for settings adjustments, and offers charging information for seamless power management.

The inverter/charger functions as a pass-through, automatically directing 120V AC shore power to the onboard electrical system to operate appliances such as the electric element of the heating and hot water system, air conditioner, cooktop, microwave, and 120V receptacles. When shore power is unavailable, the inverter converts DC power from the house batteries into 120V AC electricity to run these same systems. Additionally, the charger converts 120V AC power into 12V DC to recharge the house batteries and supply power to the 12V DC system.

 The Xantrex app enables remote monitoring and management from a connected device. To learn more or download the app, scan the QR code, visit your app store, or go to the manufacturer's website at <https://xantrex.com> and navigate to the product page. If viewing a digital version of this manual, click one of the icons below. Additional component instructions may be included in your Airstream Owner's Packet.



NOTICE

Airstream calibrates all settings at the factory and recommends adjustments not be made.

NOTE

Even when not using 120V AC power, the inverter will draw a small amount of power if left on. To conserve battery power, turn the inverter off when not in use. Overloading the inverter will cause an automatic shutoff to activate. Removing the load will allow the inverter to reset.

12V Power Loss/Backup Converter

The backup converter provides emergency power for all 12V systems, ensuring your Airstream remains operational in the event of a 12V power loss. This redundancy feature is designed to keep your Airstream functional when connected to external AC shore power until the system can be serviced.

Before using the backup converter, verify that the 12V system is truly offline. First, ensure the battery disconnect switch is in the ON position by cycling it off and back on again. If you're connected to shore power or running the generator but still have no 12V power, check that the entire 12V system is down — not just a single circuit (i.e., no lights, no Firefly display, etc.). A single circuit issue may be caused by a blown fuse and wouldn't require the use of the backup converter. Finally, ensure the 110V breakers for the inverter are switched on, as the converter will not function if it cannot receive power when plugged in and the battery is dead.

Once a complete 12V failure is confirmed, locate the backup converter under the roadside bench seat, and plug it in to restore temporary 12V power if shore or generator power is available.

NOTICE

The inverter will likely not function during this condition, so boondocking will not be possible until the system is repaired. The backup converter is intended only as a temporary emergency 12V power supply. The system should be serviced as soon as practicable to restore full functionality.

House Battery Pack

Your Airstream comes standard with the Advanced Power system, which includes three 270Ah Battle Born Gamechanger LiFePO₄ (Lithium Iron Phosphate) batteries, providing a total capacity of 810Ah. These batteries are housed in a pack mounted to the undercarriage at the rear of the vehicle. The system can be upgraded to Advanced Power Plus, expanding capacity to 1,350Ah by adding two more 270Ah batteries under the curbside bench seat, for a total of five batteries. This upgrade is available exclusively through authorized Airstream dealers. Contact your Airstream dealer for more details.

 The following is an overview of the type of batteries installed in your Airstream and the battery management system. Please read the Battle Born Gamechanger 3.0 manual (in your Owner's Packet) to learn more about using and maintaining the batteries. For additional information, scan the QR code above to visit <https://battlebornbatteries.com/> and navigate to the Gamechanger 3.0 information page.

⚠ WARNING

For detailed information regarding your lithium batteries, refer to the Battle Born documentation in your Airstream Owner's Packet. It is essential to review all manufacturer instructions, safety guidelines, and warnings before operating or servicing the battery system.

A full discharge and recharge of the battery defines a cycle. The number of cycles a lithium-ion battery can sustain varies depending on its usage. A battery that is consistently discharged to only 50% SOC will have more cycles than a battery that is frequently discharged to 0% SOC. To learn about battery about charging options, see [Battery Management and Charging](#) on page 5-16.

Battery Management System (BMS)

The BMS is an internal component of the battery and is crucial to ensuring safe operation. The BMS monitors cell voltages, currents, and temperatures to ensure they operate in a safe range and will shut the battery down should any faults occur. The following are features of the BMS:

- Over/under voltage protection
- High current protection/short circuit
- High-temperature protection
- Low-temperature charging protection
- Cell balancing

High Voltage Disconnect

If an individual cell voltage exceeds a prescribed threshold during charging (approx. 14.7V), the BMS will prevent a charge current from continuing. Discharge is always allowed under this condition.

NOTICE

Even though the BMS will protect against issues from overcharging, it should be avoided. The recommended specs are 14.2-14.6 bulk/absorb and below 13.8 float.

NOTE

If the battery has not been balanced for a long period, a high voltage disconnect could occur at a lower voltage. The battery will rebalance after several full charges.

Low-Voltage Disconnect

If an individual battery cell falls below a prescribed threshold during discharge (approximately 10.5V), the Battery Management System (BMS) will prevent further discharge to protect the battery. If this occurs, you can wake the battery by connecting the coach to external power using the shoreline power cord or by driving the vehicle, which allows the alternator to charge the battery. Bringing a battery out of low-voltage disconnect only wakes it, enabling it to accept a charge. However, without an active charging source such as shore power or alternator charging, the battery may return to low-voltage disconnect.

NOTICE

The manufacturer states you should charge (wake) your battery within 24 hours of entering low-voltage disconnect; otherwise, you risk damaging the battery and voiding the warranty.

Temperature Limits

- The battery has an operating temperature range of -4°F (-20°C) to 135°F (57.2°C).
- The BMS will not allow a charging current under 25°F (-3.9°C) but will continue to discharge down to -4°F (-20°C).
- The BMS will not allow a charging or discharging current if the internal temperature of the battery has reached 135°F (57.2°C)

Battery Heaters

The house batteries are equipped with internal heaters to maintain optimal performance in cold conditions and to facilitate charging by keeping the battery temperature above the threshold at which the Battery Management System (BMS) prevents charging. These heaters are controlled by a key switch in the rooflocker above the galley near the entrance. The battery disconnect does not need to be turned on for the heaters to function.

It's important to note that the BMS will prevent charging if the battery's internal temperature drops below 25°F (-3.9°C). When the key switch is turned on, the heaters automatically engage below 35°F and disengage above 45°F, maintaining a safe charging range. The key switch can generally remain on and requires no user input during normal use. It should only be turned off during long-term storage (3 months or more) when the unit isn't plugged in, to prevent battery over-discharge from heater draw.

NOTE

The BMS will not allow a charging current if the internal temperature is below 25°F, and it will not allow charging or discharging current above 135°F.

NOTE

If the battery is in low-voltage disconnect mode and the battery temperature is below 35°F, the heat function will need some time to warm the battery before performing the wake-up procedure.

Battery Management and Charging

Battery Monitoring/State of Charge (SOC)



Your coach is equipped with a Victron Energy SmartShunt, an advanced battery monitor that measures and communicates key battery parameters without the need for a traditional display. The SmartShunt connects via Bluetooth to the VictronConnect app on your connected device, allowing you to monitor real-time data such as state of charge (SOC), voltage, current, power consumption, and estimated remaining battery life. This information assists in effectively tracking and managing your energy usage.

To learn more or download the app, scan the QR code above, visit your app store, or go to the manufacturer's website at <http://www.victronenergy.com> and navigate to the product page. If viewing a digital version of this manual, click one of the icons below. Additional component instructions may be included in your Airstream Owner's Packet.

Use the code 000000 to sign up



If the inverter use is extensive, the house battery will deplete much quicker. Even when not using 120V AC power, the inverter will draw a small amount of power if left on. When not in use, turn the inverter off to conserve battery power.

If you plan on staying longer without access to a charge or plans to drive and charge from the alternator, you will want to conserve your battery power by using as few lights and appliances as possible. The two most significant loads on the battery are heating and cooling. The more these systems run, the more energy consumption. Consider reducing the temperature on the thermostat when using the heater and increasing the temperature on the thermostat when using the air conditioner.

Charging via Shoreline Connection

Plug the SmartPlug Cordset (shoreline power cord) into an external shoreline power supply (city power). Check that the cordset LED indicator light is blue, then plug the other end into the coach's roadside SmartPlug inlet. For more information about establishing a safe shoreline connection, at home or away, see [Shoreline Power Inlet and Cordset on page 6-8](#).



Next, select the appropriate service mode to match available shore power; see [Energy Management System \(EMS\) on page 5-12](#).

The amount of time it takes to charge the batteries depends on a variety of factors, including available shore power amperage, state of charge of the batteries, efficiency of the onboard charger, ambient temperature, and any power usage within the coach. Higher amperage shore power connections (such as 30A service) allow for faster shore charging while lower amperage connections (such as 15A or 20A) will extend charge times. Additionally, extreme cold or heat can affect lithium battery charging efficiency. For a full charge from a depleted battery pack condition, typical 30A charge times for the Advanced Power 3-battery system average around 5 hours, while the Advanced Power Plus 5-battery system typically takes about 9 hours under optimal conditions.

DC-DC Charger, REDARC Alpha

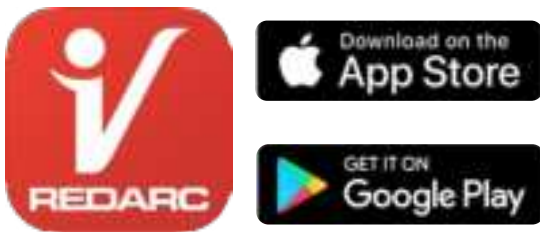
The REDARC BCDC Alpha, DC-to-DC charger, charges the house battery pack using available solar power, supplementing with power from the chassis battery as needed. Once the house battery is fully charged, excess solar energy is directed to the chassis battery. The unit operates automatically, requiring no user interaction, and draws from the chassis battery only when necessary and only while the engine is running, minimizing alternator load and maximizing solar energy use. Built-in isolation prevents the house batteries from draining the chassis battery when the vehicle is not running.





 The charger also includes a Start Battery Recovery feature—a function that resembles a  jump-start—safely supplying a bulk charge to the chassis battery to help get the vehicle running again if the chassis battery is depleted. This can be initiated remotely via the RedVision® app. Refer to the REDARC Alpha manual and RedVision app for complete details. To learn more or download the app, scan the QR code above, visit your app store, or go to the manufacturer’s website at <https://www.redarcelectronics.com/us/> and navigate to the product page. If viewing a digital version of this manual, click one of the icons above.

Charging via Solar Power

To maximize efficiency, ensure the solar panels remain clean and unobstructed by trees or structures that could block sunlight. For information on how solar charge is managed, see [DC-DC Charger, REDARC Alpha on page 5-17](#). Your Airstream includes solar ports for connecting portable panels, allowing flexibility in different use scenarios; see [Solar Ports on page 6-9](#).

Charging via Secondary Alternator

Your Airstream is equipped with a secondary alternator that charges automatically while driving, with no user interaction required. This alternator supplements the vehicle’s primary alternator, providing high-output charging to quickly replenish the house battery bank.

 The secondary alternator features a high-energy external Bluetooth regulator, which can  be monitored and optimized using the ARCO Zeus app. This system enhances charging efficiency, especially during extended trips, ensuring that you have ample power reserves for off-grid use. To learn more or download the app, scan the QR code above, visit your app store, or go to the manufacturer’s website at <https://arcomarine.com> and navigate to the product page. If viewing a digital version of this manual, click one of the icons below. Additional component instructions may be included in your Airstream Owner’s Packet.



The app features Generator Mode, capable of delivering up to 3,000W of idle charging under certain conditions. This feature allows battery replenishment even when stationary. However, prolonged idling is not recommended, as it increases fuel consumption and engine wear.

Best Practices for Optimal Performance:

- Allow the alternator to naturally charge the battery bank while driving.
- Use generator mode only when necessary and avoid extended idling.
- Monitor system performance using the ARCO Zeus app, which provides real-time system data and charge optimization.

NOTICE

While generator mode provides significant power, prolonged idling is not recommended by Airstream or Mercedes-Benz (refer to your vehicle Owner’s Manual). Do not park and rev the engine, as this may cause engine damage and could void your Mercedes-Benz warranty.

Multiplex System



Screen images may vary slightly with continuous improvements/firmware updates

The Firefly Multiplex System simplifies control of your touring coach's key features by integrating them into a single, intuitive touchscreen interface. Tapping a function icon toggles that system on or off. In most cases, icons are white when off and turn blue when on, although some controls, such as Light Master or Panel Lights, may not follow this color scheme.

The Home screen provides quick access to frequently used functions, along with real-time readings of tank levels and the status of major onboard systems. Use the menu bar on the left side of the screen to navigate to additional control pages for features such as lighting, awning, ceiling vent fan, and more—depending on your coach's configuration. A dedicated Settings screen is also available for adjusting general system preferences.

Although the interface is designed to be intuitive and easy to use, detailed instructions for specific systems are provided throughout this manual in their respective sections.

NOTICE

The Multiplex System is self-resetting should a circuit trip. The owner should never need to reset the system for any reason. If the main control panel or remote panels are not operating, this could indicate a short in the wiring that will require service by a certified technician.

NOTICE

You may encounter Warning screens when entering settings. Some Changes will affect functions of the touchscreens and your touring coach and should only be changed by a trained technician.

Cleaning the Multiplex Touchscreens

To clean the glass surface of the LCD touchscreens, power down the system and then gently wipe it with a soft, slightly damp cloth (using ONLY minimal amounts water or lens cleaner). Ensure the LCD is fully dry before powering the system up again.

NOTICE

The components of the Firefly system must not be exposed to liquids or moisture of any kind. The only approved exception is cleaning of the glass surface of LCD touchscreens.

Multiplex Bluetooth® App

The multiplex system can be controlled wirelessly via Bluetooth® connection using the Vegatouch Mira app while in proximity to the touring coach. To download the app and connect via Bluetooth®:

1. Go to the settings screen on the multiplex panel inside your touring coach and tap the gear icon.
2. Select “mobile app” to reach the Mira information page where the required PIN is displayed.
3. Scan the QR code, download the app, and follow the on-screen instructions to connect using the PIN.

If you are unable to scan the touchscreen’s QR code, search your app store for Mira, or if viewing a digital version of this manual, click one of the icons below.

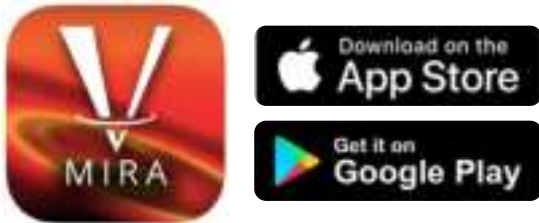

Lighting

Ceiling and Directional Lights

The Multiplex System touchscreens control the LED lighting throughout your Airstream. The “Home” and “Lights” screens have a “Light Master” switch that will allow you to instantly turn all the interior lighting in your touring coach, on or off.

Light Master Memory Feature:

The Light Master function has a memory. If you turn off individual lights and then press Light Master OFF, it will recall what lights were on the next time you press Light Master ON, and only those lights will come on. Hold the Light Master ON for more than 1 second to reset the memory and turn on all the interior lights.

Light Master LOCK Feature:

If Light Master OFF is held or pushed twice, the Light Master On will not respond. Hold the Light Master ON to resolve.

Docking Light

The light switch at the end of the roadside bench seat, accessed by opening the rear doors, controls the docking light mounted at the top of the roadside door.

NOTE

Since your Airstream has LED lighting, there are no lights to change. If an LED light stops functioning, it will require service or replacement.

Entertainment Systems

Wireless Bluetooth Speaker



Above the galley, you will find a removable/portable and rechargeable Bluetooth® speaker housed in a spring loaded bracket. Bracket tension is adjustable with the included wrench (mounted to the underside). Refer to the provided instructions on how to connect and use the speaker.

A USB charging port and outlet can also be found near the speaker on the underside of the roof locker.

TV Pre-wire and TV/Radio Antenna



Your Touring Coach is pre-wired for the installation of a TV. There are four mounting bolts below the curbside galley roof locker for installation of a TV. The roof-mounted TV/Radio antenna receives free Local VHF/UHF TV signals and FM radio signals. The signal is boosted to maximize signal strength and provide TV and radio reception.

The antenna booster is controlled by a switch on the antenna booster's wall plate inside the curbside roof locker. Press the small pushbutton on the wall plate to turn **ON** the booster. To view cable or satellite, you will need to turn it **OFF**.

The antenna is constructed of durable automotive-grade plastic that is UV-protected, weatherproof, and capable of withstanding outdoor climates. Clean the antenna with mild soap and water only. Do not powerwash or use harsh cleaning solutions, solvents, or alcohol to clean the antenna or antenna base.

Antenna Pre-Wiring

Cable/Satellite Connection



You can establish a cable connection by attaching a service provider's coax cable to the external roadside cable inlet.

Starlink Pre-Wire

You can establish a Starlink connection using the curbside external ethernet port; [see 120-Volt Outlet and Ethernet Port on page 6-8](#). Once a connection is established externally, you can complete the set up on the interior by accessing the internal ethernet port and 110V outlet on the inside of the cab shelf above the driver's seat.

Airstream Connected RV Antenna Pre-Wire

 Your Airstream is pre-wired for the aftermarket installation of a Connected RV high-gain multi-band antenna. This antenna, along with the Airstream router (sold separately), provides access to the Internet by creating a local area network. For more information, scan the QR code above or visit <https://www.airstream.com/connected/>. Stay connected to the amenities you demand with a boosted Wi-Fi signal or a dedicated 4G LTE-A internet service (requires data plan activation). Contact your preferred dealer's service department to schedule your installation.

NOTE

A data plan is required to activate the Connected RV features when purchasing an Airstream antenna and router. Instructions on setting up and data plans will be included with the router.

Appliances

The appliances installed in your Airstream typically include manuals provided by their respective manufacturers, which are often found in your owner's packet. If a manual didn't come with the appliance, the Certified Performance Checkout sheet in your owner's packet lists the manufacturer, model, and serial number for each appliance.

⚠ WARNING

Always read and follow each appliance manufacturer's instructions before use. Their manuals include critical safety information and guidance on proper use and maintenance.

The information contained in the appliance manuals supersedes any information contained in the Airstream Owner's Manual content on appliances. If you believe contradictory information on appliances is contained in this manual, or if any appliance manuals have not been provided with your Airstream, contact your dealer, the respective appliance manufacturer, or Airstream Customer Service at 937-596-6111 or email: support@airstream.com.

Maintenance

Follow the instructions and Warnings noted in the respective appliance and equipment owner's manuals.

Air Conditioner

The roof A/C used on Airstream Touring Coach's are one of the most popular on the market today. In your owner's packet is a set of literature covering all operating and maintenance instructions. If the literature is misplaced, contact the A/C manufacturer or your Airstream dealer for replacement.

Proper voltage to the A/C is critical. A volt meter check may find voltage much lower at a campground shoreline outlet than the needed 110 to 120 volts. Your A/C may not function if the voltage is too low. Low voltage is usually associated with older or poorly maintained motorhome parks. Parking your touring coach so the power cord can be plugged in to a receptacle close to the fuse or circuit breaker box can alleviate low voltage problems. Avoid extension cords and adapters whenever possible. If an extension cord must be used, it should be rated at 30 amps and as short as possible to provide the most current.

If high temperatures are expected, make an effort to park in a shaded area. Starting the A/C early in the morning also helps. It is more efficient to hold a comfortable temperature than it is to lower the temperature after the interior of the touring coach is already hot.

NOTICE

Review the air conditioning literature supplied in your owner's packet before proceeding.

NOTICE

It is recommended to clean filters Weekly when A/C is in full use.

Cooktop

Your Airstream is equipped with a single-burner induction cooktop, which requires specific types of cookware to function properly. Unlike traditional cooktops, which use an open flame or electric element to heat the pan, an induction cooktop uses magnetic induction to generate an electrical current directly in the cookware. This causes the pan itself to heat up—rather than the cooktop surface—resulting in faster, more efficient cooking and improved temperature control.

Cookware must be made from a metal that responds to a magnetic field. Cast iron and most types of stainless steel are compatible. Other types of cookware, such as aluminum, will only work if specifically designed for induction use with a bonded layer that responds to a magnetic field.

To test if cookware is compatible, simply hold a magnet to the bottom. If the magnet sticks, the cookware should work with the induction cooktop.

⚠ WARNING

An operation manual for the range has been provided with your owner's packet. Their manual contains specialized warnings and cautions that should be reviewed prior to operating the appliance.

NOTICE

The outlet on the front of the curbside galley is controlled by the EMS and was designed with cooktop use in mind and is the only outlet the cooktop should be plugged into; see [Outlets and USB Ports](#) on page 5-10

Ceiling Vent Fan

It is recommended to use the ceiling vent fan to remove hot air from inside the touring coach when the outside temperature does not require air conditioning or when cooking to remove smoke, steam, and other cooking fumes and odors. The ceiling vent fan can create a balanced airflow by opening a window during operation, allowing fresh air to be drawn in while hot, stuffy air is exhausted. The controls for the roof vent have been incorporated into the Multiplex System.

Operation

Manual Mode; open or close the vent lid by pressing the UP/DOWN icons on the multiplex touchscreen. Turn the fan on or off and select the desired fan speed.

Auto Mode; the fan has a built-in thermostat controlled by the multiplex system. Press AUTO, then tap the UP/DOWN icons to set the desired temperature. The vent lid will automatically open, and the fan will turn on and off as your touring coach heats up and cools down.

NOTE

The vent can be put into AUTO only when HVAC is set to off. In AUTO, the vents will only shut off and close when the internal temperature is 2° below the set point. Setting the climate control to anything other than off will bring the vent fan out of auto mode.

Rain Sensor

The fan is equipped with a rain sensor. When it becomes wet, the dome automatically closes, and the fan turns off. The dome will reopen once the sensor has dried out, and the fan will restart.

Cleaning Instructions

1. Turn the fan motor off and remove power by turning off the battery disconnect.
2. Rotate the screen retainers to remove the screen.
3. Clean the screen with a mild soap and water solution, air dry, and reinstall.

⚠ CAUTION

Do not operate the fan with the screen removed as this could result in damage or injury.

NOTICE

Never place Lindeen™ or a similar cover over the ceiling fan. Greatly restricted airflow and increased sound levels will occur.

NOTICE

Do not use petroleum containing additives or solvent based products on any of the vent's components. The use of non-compatible chemicals will cause cracking and product failure.

Exhaust Vent



Operation

The bath exhaust vent removes moisture from the air when using the shower. To operate, you first need to open the vent by pushing upward on the handle. Once open, turn the fan on by pressing the ON/OFF button.

Turn the fan off before closing the vent. Pull down on the handle to close.

NOTICE

Turn off the fan before closing the vent. Damage to the motor can occur if the fan runs with the vent closed. Always close the vent prior to travel.

⚠ CAUTION

Do not operate the fan with the screen removed as this could result in damage or injury.

Furnace and Water Heater



⚠ WARNING

For detailed information regarding your Truma furnace and water heater, refer to the Truma documentation included in your airstream owner’s packet. It is essential to review all manufacturer instructions, safety guidelines, and warnings before operating or servicing the system.

NOTICE

Please ensure your fuel tank is at ¼ before attempting to start the system. Starting with a low fuel level can cause the system to fail to ignite, lead to repeated error codes, and eventually lock out the unit, requiring service. Always check fuel level first to avoid unnecessary issues.

Overview

Your Airstream is equipped with a Truma Combi diesel/ electric combination furnace and water heater, which draws diesel fuel directly from the Sprinter’s fuel tank. To protect the vehicle from running out of fuel, the Truma system will automatically shut off when the Sprinter’s fuel level drops to one-quarter tank. It is operated via the Truma CP Plus Control Panel.

The Truma system offers three selectable modes of power: diesel, electric, or a diesel/electric mix, allowing flexibility depending on your location and available resources. There are two main operating modes to choose from:

Heating Mode – In this mode, the furnace automatically selects the appropriate operating level based on the difference between the set temperature and the actual room temperature. If water is present in the tank, it will be heated automatically as well. The water temperature is not regulated in this mode but can reach up to 162°F.

Hot Water Mode – Ideal when only hot water is needed. The lowest burner setting is sufficient for this, and the burner shuts off once the water reaches the selected temperature.

Notably, the furnace can be operated even if the water tank hasn’t been filled, giving you greater flexibility in cooler weather.

Troubleshooting

For detailed troubleshooting information regarding your Truma furnace and water heater, refer to the Truma documentation included in your airstream owner’s packet. When the system is turned on, it will automatically go through three start attempts. These are usually undetectable. If it does not ignite, an error code (E560) will appear on the control panel screen. If this occurs you must reset the unit at the control panel (refer to the Truma manual for detailed instructions). Upon reset, reselect the desired heating mode. The system will then automatically attempt to start three more times. If it still fails to ignite, the same error code will appear again.

At this stage, it is strongly advised to stop and check the vehicle’s fuel gauge. In most cases, the system fails to start because the fuel level is too low. If the gauge confirms there is at least a quarter tank of fuel remaining, contact the Truma call center or an authorized service center before proceeding.

While the system technically allows for two more manual reset attempts, further attempts should not be made.

Continuing to reset and attempting ignition beyond two attempts risks locking out the unit entirely, which requires professional servicing to correct.

NOTICE

Make sure the water heater bypass valves are in their normal operating positions. If the bypass valves are left open this will cause an insufficient hot water supply; see [Component Locations for Winterization on page 9-9](#)

NOTICE

The furnace/water heater does not feature a freeze-protection function. The water container must be drained if the coach will not be used whenever there is a risk of freezing.

NOTICE

The furnace/water heater manufacturer does not recommend blowing air through the water heater or adding antifreeze to the water heater.

Truma Combi Control Panel

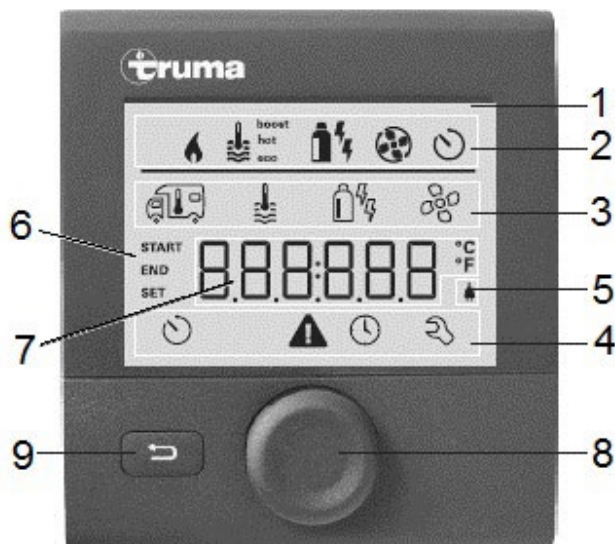

The Truma Combi panel controls and monitors the combination furnace and water heater.

1. Display
2. Status line
3. Menu line (top)
4. Menu line (bottom)
5. Power supply display 120 VAC (main supply)
6. Time switch display
7. Settings/values
8. Rotary push button
9. Back button

NOTICE

If warranty service is required, use only a service location recommended by the furnace manufacturer or your Airstream dealer.

Safe Operation

Never run the heating/hot water system while refueling the vehicle, and do not run the fuel fired function in an enclosed building or a partly enclosed area such as a garage where exhaust fumes can accumulate and create unsafe conditions.

For information on the safe operation of this system read the Truma user manual, and also, see [Diesel Operated Systems](#) on page 2-2 and see [Diesel Exhaust](#) on page 2-7.

⚠ DANGER

Never operate the furnace/water heater while refueling the vehicle. The furnace/water heater vents to the exterior. When parked near a fuel pump, gasoline fumes can enter vents and ignite from a burner flame, CAUSING A FIRE OR AN EXPLOSION.

⚠ DANGER

Never operate the furnace/water heater in an enclosed or partially enclosed area, such as a garage, where exhaust fumes can accumulate and create a hazardous condition; see [Diesel Exhaust](#) on page 2-7

⚠ WARNING

Scalding injuries caused by hot water! Water temperatures over 127 °F (52 °C) can cause severe burns or scalding and, in extreme cases, even death. Water in the hot water container can reach a temperature as high as 162°F (72°C) during operation. If there is a malfunction, the water can reach 205 °F (96 °C).

⚠ WARNING

NEVER store flammable material in close proximity to the exhaust outlet on the side of the touring coach. Hot exhaust system components can cause burns if touched, even briefly.

Exhaust and Condensation Spout

The exhaust for the combination furnace and hot water heater is on the roadside exterior; see [Exterior Components](#) on page 6-4. The provided spout can be clipped onto the exhaust to direct condensation away from the body of the vehicle, but is only intended to be installed when the vehicle is stationary.

⚠ CAUTION

Remove the condensation spout before driving. Leaving it in place while driving may result in the spout falling off.

Hot Water Tempering Valve



A hot water tempering valve (thermostatic mixing valve) is a 3-way valve that mixes cold water with hot water to reduce the temperature and prevent scalding. The valve is located near the water heater on the roadside interior, below the access panel, under the bench seat cushion and should not require adjustment. For location, see [Component Locations for Winterization on page 9-9](#).

<p>⚠ WARNING</p>
<p>If it is necessary to make tempering valve adjustments, exercise caution. Water temperatures over 127 °F (52 °C) can cause severe burns or scalding.</p>

Water Heater Pressure Relief/Drain Valve



The dual-purpose pressure relief/drain valve provides both pressure relief and drain functions. The pressure relief/drain valve is a safety component and must not be removed. Should the valve be activated (manually or under pressure), water will drain from the line extending through the floor to the exterior. For more information and location, see [Component Locations for Winterization on page 9-9](#).

Microwave

Refer to the Certified Performance Checkout sheet, included in your owner’s packet, for manufacturer, model, and serial number information. Depending on the manufacturer, Instructions may be included in your owner’s packet.

Refrigerator

Review all refrigerator literature supplied in your owner’s packet or stored in the refrigerator prior to operating it.

Operation

The refrigerator is all-electric and features a strong 12-volt compressor, which results in a powerful cooling performance. No LPG is required. The ventilation is integrated which also means that outside vents are also not required.

The refrigerator has a very quiet compressor. The standard noise level reaches 32 dB(A). If you want to reduce the noise level further, you can activate the night mode, which drops the noise level an extra three decibel to 29 dB(A).

Even in storage, prevent moisture, mold and unpleasant odors in the refrigerator by holding the door open. Use the sliding latch at the top of the door to keep door open. Remember to keep the freezer door open too.

Defrost and Cleaning

The frequency of defrost is dependent on the number of door openings, the ambient temperature and the humidity level. Typically, it is a good practice to defrost once there is ¼ inch of frost buildup. When defrosting, power off the unit. Prop the door open. We suggest placing a towel in the bottom of the refrigerator and in the freezer compartment to catch excess moisture.

Now that the unit has been defrosted, the interior can be cleaned with a non-abrasive cleaner. Do not use “Brillo” or “SOS” type abrasive pads, as they will score the surfaces. Baking soda is also not recommended.

<p>NOTICE</p>
<p>Speeding up the defrost process with a knife or scraper is strongly discouraged due to the likelihood of rupturing the refrigerant circuit.</p>

AIRSTREAM®

Section 6 EXTERIOR

EXTERIOR CARE	6-2	AWNING	6-9
Painted Surface Care	6-2	Awning Use In Wind and Rain6-10
Washing the Exterior	6-2	Awning Manual Override6-10
Protecting the Exterior	6-3	Care and Maintenance6-10
Seam Sealant Inspection	6-3	SCREEN DOORS6-11
Body Kit.	6-3	Sliding Screen Door6-11
EXTERIOR COMPONENTS	6-4	Rear Screen6-11
Roadside	6-4		
Curbside	6-5		
EXTERIOR FEATURES	6-6		
Windows	6-6		
Gravity Water Fill	6-6		
City Water Hookup	6-6		
Exterior Shower	6-6		
Sprayer Port	6-7		
Brushguard	6-7		
Off Road Lights	6-7		
Fox Performance Elite Series shocks	6-7		
Shoreline Power Inlet and Cordset	6-8		
120-Volt Outlet and Ethernet Port.	6-8		
Solar Ports	6-9		

Exterior Care

 Airstream Supply Company is your trusted source for Airstream-approved cleaners, sealants, and other care products and supplies needed to properly maintain your Airstream's exterior. Scan this QR code to visit and explore our recommended assortment of RV care products and much more at airstreamsupplycompany.com.

Mercedes-Benz Sprinter painted the exterior of your Airstream before it arrived at the Airstream factory. The Airstream up-fitted and body kit portions were sent out and painted for Airstream during production.

⚠ WARNING

Your Sprinter Owner's Manual contains detailed cleaning and care instructions for painted surfaces and important safety information. Please read Sprinter's Cleaning and Care instructions before proceeding.

Airstream provides this section to help you understand the finish and its care. Following these instructions will help maintain your recreational vehicle's high-gloss finish.

⚠ WARNING

Information on finish care may provide additional information and tips on the use of the Sprinter Van as a touring coach, however, no information about the exterior finish of your touring coach in this manual should be interpreted as advice or directions to disregard or void the warnings, cautions, or other information contained in the Sprinter's manuals.

Painted Surface Care

The painted finish on your touring coach consists of a layer of acrylic urethane base coat paint (the pigmented application that provides the color) and a top layer of clear coat. The protective clear coat surface requires regular maintenance, especially in harsh environments where it is more susceptible to damage.

Clear coats lose gloss and appear to fade as environmental and road contaminants accumulate on the surface over time. Regular washing is necessary to keep the surface from being damaged by contaminants (like road salt). However, washing alone will not adequately remove all forms of contamination and does not provide clear coat protection.

To maintain and protect the longevity of the clear coat, the surface must be waxed or sealed periodically after washing. Waxes and sealers protect the top coat from damage caused by the accumulation of environmental contaminants like bugs, bird droppings, tree sap, acid rain, ultraviolet exposure, and moisture. They also protect against road contaminants like salt and tar and help prevent scratches, swirl marks, and chipping. As an added benefit, they enhance the appearance, improving resale value.

If the paint is chipped, it should be repaired with touch-up paint. If the base coat is exposed, it will deteriorate over time, and the exposed metal surface will eventually rust. Contact your Airstream dealer for the correct touch-up paint. Paint color codes can be found on a sticker on the driver's seat pedestal.

Clear coat surfaces that have not been well maintained can develop imperfections like oxidation, swirl marks, and scratches, which may require professional detailing (polishing). Detailing should only be accomplished by a qualified technician or professional detailer.

Washing the Exterior

Before you begin, verify that all vents and windows are closed. Ensure the touring coach's surface temperature is not too hot (under 90°F). Direct sunlight causes water and soap to evaporate quickly, resulting in water spots, so try to wash the coach in a shaded area. If only partially shaded, keep the vehicle wet by hosing it down occasionally.

Airstream recommends using microfiber wash mitts. Inspect the wash mitt each time you pull it from the bucket to ensure it hasn't picked up debris. It's good practice to use two mitts, one for the wheels and undercarriage and one for painted surfaces. Soft bristle brushes are acceptable for use on tires, wheel wells, but are not intended for use on painted surfaces.

Fill a clean bucket with warm water and mild soap or a car wash shampoo, which most auto parts stores and large retailers carry. Avoid combination wash-n-wax products, as these waxes may cause buildup and are better suited for smaller vehicles.

Working your way from the top down, start by thoroughly rinsing the entire vehicle with a hose to remove debris that could scratch the surface. Dip the wash mitt into the bucket, and without ringing it out, wash all surfaces, working your way from the top down, frequently rinsing to minimize grit abrasion. Follow with a final rinse of water.

Dry the surface and windows with a chamois or microfiber towels, working from the top down. Check for debris as you go, especially when working close to the ground. Open all the doors and wipe down the door jams, edges of the doors, and door seals. Drying and cleaning these areas can help prevent the buildup of contaminants that can hold moisture and cause rust on any vehicle. Keeping the seals and jams clean also provides a better surface for the doors to seal when closed. Finish by drying off the wheel rims and tires.

⚠ WARNING

Do not use a round spray nozzle when pressure washing. Doing so can cause unseen damage to tires and other critical vehicle components, which may cause them to fail unexpectedly. Maintain a proper distance of approximately 1 foot when using a 25° nozzle. Never point the jet nozzle at tires, moldings, hoses, electrical components, seals, plug connections, etc.

NOTICE

Do not use solvent-based cleaners. Refer to the Sprinter manual’s cleaning section for products to use on tough spots like insects and tree resin.

NOTICE

Never use any abrasive pads, course brushes, or harsh/abrasive chemical cleaners especially those offered by most automatic car wash operations. Wheels should be cleaned after each exposure to harmful chemicals/materials.

Protecting the Exterior

Only apply waxes or sealants directly after washing the coach to ensure no dirt remains that could scratch the paint, and only apply waxes or sealers in a shaded area. Always follow the directions on the product label. Some product labels may recommend applying wax to the entire vehicle and letting it dry before removal. However, with the large surfaces of a touring coach, it is best to work in sections, applying the wax to a portion, letting it dry, and removing it before moving on to another section. Use a high-quality microfiber towel to remove wax. Turn the towel frequently. Check the towel for debris as you go, especially when working close to the ground. Remove dried polish from crevices, trim, and moldings when finished.

NOTICE

Rubbing or polishing compounds should only be applied by experienced technicians.

Seam Sealant Inspection

It is recommended that the caulking and sealant used in external seams and joints, such as window frames, light bezels, beltline, rub-rail molding, etc., be checked regularly. If this material has dried out or cracked, or if a portion has fallen out, it should be replaced with fresh material to prevent possible rain leaks. Caulking and sealing products are available from your touring coach dealer, most RV supply stores, and Airstream Supply Company..

Body Kit



The body kit is made from state-of-the-art high impact plastic. The same material is used in the automotive industry for moldings, bumper guards, and trim. The body kit, hood, and grill are sprayed with an impact and abrasion coating that requires no paint or finish. The coating provides good impact and abrasion resistance, as well as excellent corrosion resistance. The cleaning procedures are the same as the painted finish on the Sprinter body; however, a soft nylon bristle brush can be used to remove dirt from the textured surface. There are several automotive care products on the market for exterior care that will provide added protection from UV ray damage. Find one you like and use it as often as needed to help prevent fading.

Exterior

Exterior Components

Roadside

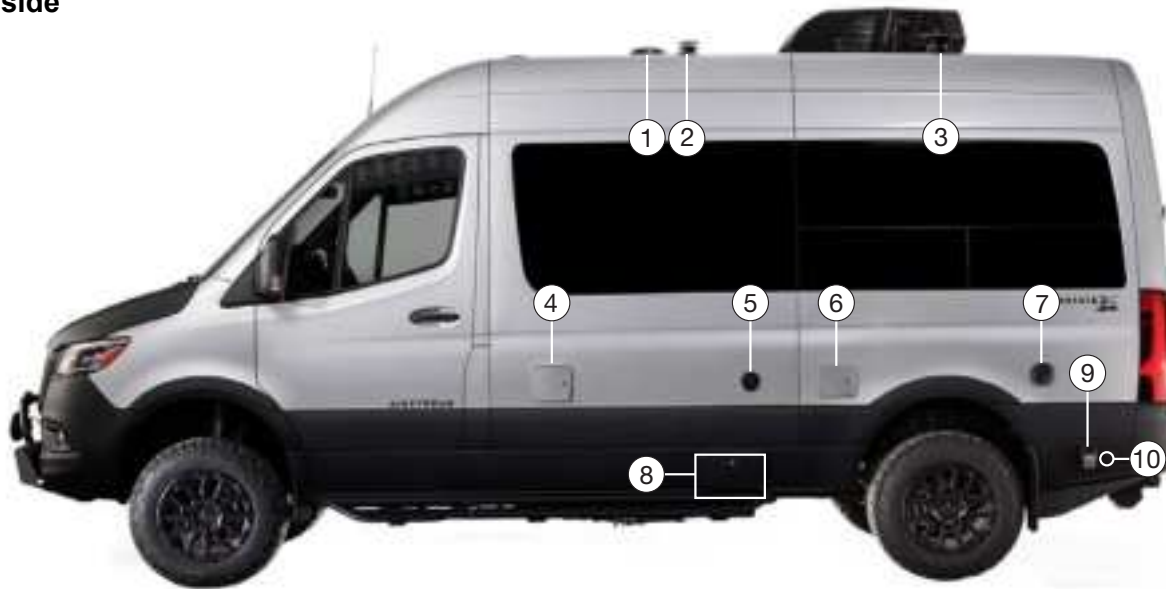

NOTE

Sections 6 and 9 contain additional information about these components. Mid-production changes may affect the exact location of the features shown above.

1. Bath exhaust vent; [see Exhaust Vent on page 5-22](#).
2. Plumbing vent.
3. Power boosted omni-directional TV antenna is wired into TV outlets on exterior of coach and inside unit at entertainment center cabinet; [see TV Pre-wire and TV/Radio Antenna on page 5-20](#).
4. Exterior shower outlet; can be used on the water pump or with the city water hookup after faucet/valve/hose assembly is inserted; [see Exterior Shower on page 6-6](#).
5. Exhaust Vent, Furnace/Water Heater; should be cleaned regularly. When operating furnace/water heater, be sure exhaust can escape into a well ventilated area. Air coming from vent can be hot. When parking the touring coach, be sure to have proper clearance in venting area; [see Furnace and Water Heater on page 5-23](#)
6. Utility hatch, contains:
 - Switches for the dump valves, macerator pump, and macerator pump high-pressure hose reel; [see Emptying the Holding Tanks on page 9-7](#).
 - Cable/Satellite TV inlet. A portable satellite dish can be connected and used in this cable connection; [see Cable/Satellite Connection on page 5-20](#).
7. City water hookup provides access for city water to your fresh water system. Use ½ inch minimum hose for water supply; [see City Water Hookup on page 6-6](#).
8. Macerator hose reel compartment stores the electric reel holding the pump hose and the waste tank flush; [see Macerator Pump on page 9-6](#).
9. SmartPlug Power Cord Inlet: the 30 amp power cord is stored inside the vehicle and is used to provide external AC power to the touring coach; [see Shoreline Power Inlet and Cordset on page 6-8](#).
10. Solar Port: designed as a quick plug-in for a portable solar charging kit; [see Solar Ports on page 6-9](#).

Curbside

**NOTE**

Sections 6 and 9 contain additional information about these components. Mid-production changes may affect the exact location of the features shown above.

1. Roof air conditioner; [see Air Conditioner on page 5-21](#).
2. Awning; [see Awning on page 6-9](#).
3. Airstream Connected RV Antenna Pre-wire. Provides access to the internet by creating a local area network. Antenna and router required (sold separately); [see Airstream Connected RV Antenna Pre-Wire on page 5-20](#)
4. Solar Port: designed as a quick plug-in for a portable solar charging kit; [see Solar Ports on page 6-9](#).
5. Exterior 120-volt outlet provides an exterior GFCI protected electrical source; [see 120-Volt Outlet and Ethernet Port on page 6-8](#).
6. Ethernet Inlet; [see 120-Volt Outlet and Ethernet Port on page 6-8](#) and [see Starlink Pre-Wire on page 5-20](#)
7. Cab window inserts; louvered and screened, these vents provide ventilation and are held in place by rolling up the window.

Exterior Features

Windows

Clean your touring coach windows the same way you clean the windows in your home. Clean the seals with a damp cloth and mild detergent every 3 to 6 months. Do not use strong solvents, as they will damage the seals. A coat of natural silicone lubricant applied after the seal has dried will keep it flexible. Spread the lubricant evenly with a brush or finger, working it into the surface. This is a good practice for all rubber seals in your touring coach.

⚠ WARNING

Failure to properly clean and lubricate the window seals could result in the window sticking to the jamb and should only be released by a qualified technician trained in the procedure. Do not force, pry, or apply great pressure to open the window. Failure to heed this warning may cause the window to shatter and/or cause personal injury.

For replacement of a damaged window, contact an Airstream Service Center.

Gravity Water Fill

The gravity water fill is located on the backside of the galley cabinet. It is used to fill the fresh water tank with potable water. A small vent is located next to the port to allow air to expel from the tank as it is filled.

Fill the water tank by opening the sliding door. A high-pressure RV/Marine FDA approved drinking water hose of at least 1/2-in. diameter made from material that is tasteless, odorless, and non-toxic can now be inserted. It's a good idea to let the water run through a hose for a short time to flush it out. RVers sometimes fill their tanks with "home" water to avoid strange water that may be distasteful to them on short outings. Remember, the more water you carry in the Fresh Water tank, the less cargo carrying capacity you have for other items. The amount of water in the tank may be checked on the Multiplex Control Panel.

NOTICE

Since the fresh water tank fill is essentially in the interior of the unit. Please monitor the amount of water you are putting into the tank to ensure that you do not have overflow into the coach.

City Water Hookup



The city water hookup is located on the roadside of the touring coach. For consistent water flow and plumbing line safety, an in-line regulator limits pressure to 50 psi.

Use a tasteless, odorless, non-toxic, high-pressure hose of at least 1/2-in. diameter designed for touring coach use. The city water inlet is a standard garden hose thread. We suggest you carry two lengths of hose in order to reach hookups farther away than normal, as well as to have a spare.

After hooking up the hose and turning on the city water valve provided in the park, slowly open a faucet. There will be a lot of spurts and sputtering until all the air is expelled from the touring coach system. It may take some time before all the air is expelled and a steady flow of water occurs. Once a steady flow is achieved at one faucet, the others should be opened long enough to expel the air in the lines going to them.

Exterior Shower



All units are equipped with an exterior shower. This shower consists of a shower hose, shower head, and water valves inside a lockable exterior door. Water is supplied by the pump or city water hookup. To use: insert the hose into the inlet, pull back slightly to verify it is securely connected. Press the spout button and rotate the faucet handles to the desired temperature. To remove the hose assembly, hold back the water inlet fitting while simultaneously pulling out on the hose fitting. Be sure to press the spout button to relieve any residual pressure before removing the hose.

Sprayer Port



Inside the rear door on the roadside bench seat is a sprayer port that allows connection of the provided quick-connect hose and sprayer nozzle. Water will flow from the onboard fresh water tank (when the water pump is on while boondocking) or city water when connected to a city water source.

To connect the hose, push the hose fitting into the port until the quick-connect engages. To disconnect, push in on the quick-connect collar to release the hose.

NOTICE

The port is under pressure when the water pump is on and when the coach is connected to a city water supply. It is recommended to briefly turn off the water pump or external water supply when connecting and disconnecting the hose.

Brushguard



The trailhead brushguard mounted on the front of the vehicle functions only as a mounting system for the lights and is otherwise aesthetic only.

⚠ WARNING

Do not use the brushguard to tow, push, or pull. Placing a load on the brushguard could result in a failure leading to property damage, personal injury, or death.

Off Road Lights



The Interstate 19X is equipped with KC lights mounted to the brushguard. The switch to operate the KC lights is located on the dash just below the engine start button. Remove the light covers prior to operation. To remove, pull at the top of the KC cover. To reinstall the covers, place the bottom on first and snap the top back into place.

⚠ CAUTION

The exterior lights are not intended for on-road use and may be restricted by law. Traffic laws may require covering the lights when traveling on-road. Adhere to state and local laws pertaining to the legal use of the light accessories.

NOTE

The chassis battery powers the KC lights. Keeping the engine running while the lights are on is recommended to avoid draining the chassis battery. Since the chassis battery powers the lights, the lights will remain on even if the house battery disconnect switch is turned off.

Fox Performance Elite Series shocks

 Your Airstream is equipped with adjustable shocks, which are pre-set at the factory for optimal performance but feature tool-free compression damping adjustment, allowing you to tailor ride characteristics to driving conditions. Consult the shock manufacturer's manual for instructions on making safe and proper adjustments, and for cleaning and care procedures. If a manual was not provided, scan the QR code above to visit <https://ridefox.com/>.

⚠ WARNING

Improper adjustment or maintenance beyond the tool-free compression damping adjustment can alter handling characteristics, increase the risk of loss of control or rollover, and may void your warranty. Any service beyond tool-free adjustments must be performed only by qualified service technicians. The shocks are gas-charged and highly pressurized; improper handling can result in SERIOUS INJURY or DEATH.

Shoreline Power Inlet and Cordset



Your Airstream is equipped with a SmartPlug power inlet located on the exterior, roadside rear.

Before connecting power to your Airstream, plug the cordset (power cord) into the power source and check the cordset's Power Indicator Light. When the SmartPlug cordset is connected to a power source the LED light on the plug will indicate the following:

- Blue ON - normal power condition. OK to proceed.
- Blue OFF - no power condition. Check Connection and power.

In some older parks and other locations where three-pronged outlets are not available, certain precautions to ensure proper grounding and polarity must be taken. These precautions are listed below:

1. Attach the three-pronged plug to a two-pronged adapter. The third conductor line of this adapter has a short wire lead that must be grounded.
2. For proper grounding, connect the short ground lead to a grounded outlet box or to a cold water pipe. When no water pipe is available, drive a metal rod two feet into the ground and attach the ground lug to it, thus providing the unit with proper grounding.

NOTE

When the three-pronged plug can be used, there will be no problems with proper polarity or grounding with a properly-wired shoreline outlet.

As an RV owner, you may want to install a 30A 120V AC outlet in your home so you have a shore power hookup readily available. However, you must have the proper outlet installed. Typical household 30A outlets are wired 240 VAC for home appliances. **RV outlets are 30A 120V AC.** Ensure your electrician is aware of the difference, or they may mistakenly wire the outlet to 240 VAC.

NOTICE

Do not connect to a 240 VAC outlet. Connecting to a 240 VAC outlet may result in permanent damage not covered by warranty.

120-Volt Outlet and Ethernet Port

The touring coach is equipped with a 120-volt GFCI outlet, located on the curbside rear of the coach. Next to the outlet, you will find an ethernet port. Connect any external provider's ethernet connection to establish an ethernet connection. For location, [see Curbside on page 6-5](#).

Solar Ports

 The solar ports on each side of the touring coach (see [Exterior Components on page 6-4](#)) allow plug-and-play connection of portable solar panels to augment the existing solar charging capability, but there are limits to what can be connected. For best results, use the portable solar kit specific to your model, available through Airstream Supply Company. These kits have been tested and are fully compatible. One kit can be connected to each port for simultaneous use. Scan the QR code to shop at <https://airstreamsupplycompany.com/>.

It may be desirable to park your coach in the shade on hotter days, but doing so might limit the solar charging capability of the rooftop panels. The portable kit has a cable that allows the fold-out panels to be placed away from the coach in the sun where they will still provide a charge.

If using portable solar panels other than those offered by Airstream Supply Company, consult your Airstream dealer to confirm the rated output is safe for this system. The following limits must be strictly observed to ensure proper system operation and to prevent damage:

- Combined total system output of the factory installed rooftop panels and any portable panels must not exceed the 50A/48V rating of the REDARC Alpha unit
- Each external port is rated for a maximum 20A input
- Multiple portable panels may be used across separate ports, provided that the total input through all external ports does not exceed 760W
- Portable panels must not include a built-in solar regulator

⚠ CAUTION
Exceeding any of the limits specified above may affect system charging behavior and can damage the electrical system.

Awning

 The awning manufacturer’s manual can be found in your Airstream owner’s packet or by scanning this QR code and navigating to the instructions on Carefree’s website at <https://www.carefreeofcolorado.com/>.

Extend and retract the awning and control the awning lights using the Multiplex panel.

Depending on when your Airstream was built, the awning may have a preinstalled Bluetooth® module that allows you to control awning functions using the Carefree Connects™ app. For instructions on downloading and using the app, and Bluetooth® pairing, scan the QR code above and navigate to the Carefree Connects information page.



NOTICE
Awning must be retracted before driving the Touring Coach. Damage may occur if the awning is not properly retracted. The awning will not extend while vehicles engine is running.

NOTICE
Rear doors must be closed when operating the awning or if the vehicle is left unattended, due to seismic sensor, with the awning extended. Damage may occur if the awning is extended or retracted with the rear doors open.

Awning Use In Wind and Rain

The automatic extra strong awning comes with a Direct Response™ System seismic sensor. The Direct Response™ System is an innovative seismic sensor system that automatically activates the 12V motor and retracts the awning in strong winds, thus avoiding possible damage to the awning.

NOTICE

If wind or extended periods of rain are expected, retract the awning and secure as for travel. The effects of wind and rain on any awning are unpredictable. Severe damage to the vehicle and or the awning may result and cannot be covered by warranty.

NOTICE

Never use the awning with damaged fabric. Make sure the awning can be correctly retracted.

Awning Manual Override

If power to the vehicle is not available, the awning can be safely retracted using the manual override located on the idler (right) end of the case. A ratchet and socket extension has been included and is located under the passenger side compartment floor.



1. Remove thumb screw from backside of decorative awning cap. The cap will be held in place by velcro that must be released before removing.
2. Remove cover from the right end of awning and save.
3. Insert the 3/8" socket drive extension and handle into the square drive hole inside the end cap.
4. Turn the handle clockwise until the awning is retracted.
5. Replace the end cap.

NOTICE

After closing the awning with the manual override, the lead rail may move out from the case 1/4"-1/2". This is normal and the awning is secure for travel until power is restored or repairs are completed. Do NOT attempt to force the lead rail in with the override, serious damage can occur to the awning.

NOTE

Manual override cannot be used to extend the awning.

Care and Maintenance

1. PERIODIC MAINTENANCE Like any other part of the touring coach, an owner should periodically inspect the awning. The following items should be checked.
 - a. All mounting brackets are tight.
 - b. Check all pivot points for enlargements of holes or broken rivets.
 - c. Check end caps for cracking and splitting.
 - d. Check that awning rail is tight against coach and all screws are tight.
 - e. Check canopy for loose stitching and possible shrinkage or puckering.
 - f. Clean and lubricate all tension knobs and pivot points.

Fuse Location: Chassis fuse panel under driver's seat,

Screen Doors

Sliding Screen Door

The touring coach is equipped with an accordion style screen door to provide ventilation and insect control. To operate, carefully pull the screen from its stowed position across the opening. Reverse the procedure when returning the screen door to its stowed position. The screen door should always be in the stowed position when operating the main sliding door, to prevent damage.



The screen above the galley can be opened as well, by sliding the screen up. This screen can be used to pass food, drinks, or other items outside. It can also be used to access the galley's faucet without the need to climb into the touring coach.

NOTICE

Check that the screen door is open before closing the exterior door. Failure to follow this caution could result in damage to the screen door.

Rear Screen



The rear screen is modular allowing the user to position, open, and close as desired. The edges are held in place with magnetic strips to allow for fast egress in an emergency. Push anywhere along the edge to open. The screen can be unzipped, rolled up, and held in place at the top by the attached straps, or it can be removed entirely and stowed.

AIRSTREAM®

Section 7 SPRINTER VAN

IMPORTANT SPRINTER INFORMATION	7-2	CHANGING A TIRE	7-6
Fuels and Operating Fluids	7-2	Flat Tire	7-6
Mercedes me Connect App	7-2	Precautions When Changing a Wheel	7-6
Component Identification	7-2	Procedure	7-7
Sprinter Van - Serviced by Mercedes-Benz Sprinter or Its Suppliers	7-3	Jack	7-7
Chassis	7-3	INSTALLING AND REMOVING A WHEEL	7-8
Drivers and Passengers Seats and Restraint Systems	7-3	Mounting a New Wheel.	7-8
Airstream Components - Serviced by Airstream Authorized Service Centers or Airstream suppliers.	7-3	Centering Wheels With Wheel Fasteners.	7-8
Cab Area.	7-3	Lowering the Vehicle.	7-8
Living Quarters	7-3	Wheel Bolt/Lug Nut Tightening	7-8
Electrical Components	7-3	TIRE ROTATION	7-9
Exterior	7-3	Typical Tire Rotation Patterns	7-9
TIRES	7-4	Support	7-9
Vehicle Placard and Tire Inflation Pressure Label	7-4	Correct	7-9
Proper Tire Inflation	7-4	Incorrect	7-9
Underinflation	7-4		
How Overloading Affects Your Tires	7-5		
Tires and Wheels	7-5		
Tire Grip	7-5		
Hydroplaning.	7-5		

Sprinter Van

The Airstream Interstate 19X Touring Coach is integrated into a Sprinter Van designed and manufactured by Mercedes-Benz. Operation of the Sprinter, its engine, power train, and other related components are discussed in the Mercedes-Benz Sprinter Owner's Manual and other literature provided by Sprinter. As a point of reference, those systems discussed in this literature are warranted by Mercedes-Benz or their suppliers.

Important Sprinter Information

Your Mercedes-Benz Sprinter Van Operator's and Warranty Manuals contain important Cautions, Warnings, operational, and warranty information on the Sprinter and its components. All information in the Sprinter manual should be reviewed and followed for your safety. The Airstream Owner's Manual may provide additional information and tips on the use of the Sprinter Van as a touring coach; however, no information in the Airstream manual should be interpreted as advice or directions to disregard or void the warnings, cautions, or other information contained in the Sprinter manuals. If you believe there is a conflict in information, Warnings, Cautions, or safety-related information between the Sprinter and Airstream manuals, please contact the Airstream customer relations department immediately to resolve the conflict.

Fuels and Operating Fluids

The Sprinter Operator's Manual contains important information about the fuel and operating fluids approved for use by Mercedes-Benz. Review the Sprinter manual's information and notes on maintenance, fuel grades, and Mercedes-Benz-approved operating fluids before refueling or servicing the vehicle.

Refill only with commercially available ULTRA-LOW SULFUR DIESEL (ULSD, maximum sulfur content 15 ppm). Mercedes-Benz recommends fuels with a bio-diesel content of 5% (B5) or less whenever possible. The use of B20 fuel requires special precautions addressed in your Sprinter manual.

NOTICE

Do NOT use R95 diesel fuel. Use only fuels and operating fluids approved by Mercedes-Benz. Do NOT use any fuel additives or other operating fluid additives. Using the wrong fuel, incorrect operating fluids, or both may damage the vehicle.

Mercedes me Connect App

 Access your vehicle from anywhere and experience all the benefits of ownership with Mercedes me connect. To learn more, scan this QR code or visit <https://www.mbvans.com/en/connectivity>.

The Mercedes me connect App directly pairs with your vehicle. Download the app from the link above (by scanning the QR code), or click on one of the following icons:



The app will guide you through the activation process, but you may also reach out to your Mercedes-Benz dealer to activate your account. For additional assistance, please call the Mercedes-Benz Customer Assistance Center at 877-762-8267.

Component Identification

If repairs are needed, it may be difficult to determine which parts are Mercedes-Benz and which are Airstream's responsibility. The lists on the following page show the major components of the van and the company responsible for their servicing.

 For assistance in locating a Mercedes-Benz service center in the United States, scan this QR code or visit <https://www.mbvans.com/en/vehicles/dealer-locator-pages/dealers> and use the Mercedes-Benz dealer locator, or call 877-762-8267.

See Mercedes-Benz Sprinter Warranty Information for instructions on obtaining warranty service.

Sprinter Van - Serviced by Mercedes-Benz Sprinter or Its Suppliers

Chassis

Engine	Speed control
Exterior automotive lights	Automotive electrical system
Engine battery	Instrument panel cluster
Power mirrors	Hitch receiver and tow plug
Engine cooling system	Doors, cab, side and rear cargo
Fog lamps	Heated drivers/passenger seats
Transmission	Cab door windows and windshield
Chassis suspension	AM/FM radio antenna
Brakes	Dash Multimedia Center
Drive axle and hubs	Dash AC/heater/defroster
Steering assembly, Steering wheel	Cargo door assist handle
Rear window defroster and heated windshield	Lane keeper assist
Automotive fuse panel	Blind spot assist
Wheels, Tires	High beam assist
Parking brake	Collision prevention assist
Alternator	Parktronics
Fuel pump	

Drivers and Passengers Seats and Restraint Systems

Sprinter provides the swivel pedestals and Airstream provides the seat decorative skirting and recovers the front seats to match the surrounding decor.

Airstream Components - Serviced by Airstream Authorized Service Centers or Airstream suppliers.

Cab Area

- Driver's and passenger's seat skirting and covers.
- Floor Mats
- Dash Kit
- Rear View Mirror/Monitor
- Vanity Mirrors

Living Quarters

Fire extinguisher	Three piece sun and privacy shield
Interior furniture	Window Coverings
Appliances	Floor covering
Smoke/CO detector	All plumbing systems

Electrical Components

Inverter/Charger	120-volt system
Converter	12-volt living area system
House battery	Multiplex System
Battery power button	Roof AC
Power vents	TVs and TV antenna
Secondary Alternator	

Exterior

Exterior body kit	Air Suspension System
Power step	Macerator pump
Exterior lights	Solar panels
Awning	
Windows	

NOTE

Some features listed may not be available on your touring coach.

Tires

Under inflation or over inflation of tires is dangerous. Under inflation can result in tire flexing, heat build-up, tire overloading, bad handling, bad fuel economy, and uneven wear. Over inflation can result in abnormal wear, bad handling, and a harsh ride.

Tire inflation pressures should be checked as per the Mercedes-Benz Sprinter's Owner's manual and when significantly changing the load you plan to carry in your touring coach. Set the correct tire pressure before loading the vehicle. Always check tire inflation pressures when the tires are "cold." Inflation recommendation is 47 psi for the front tires and 70 psi for the rear. Front and rear pressures are shown for each model and GVWR, and are based on the GVWR and front and rear axle ratings (GAWRs) printed on your vehicle VIN plate and certification label. Tires must be inflated to these pressures when the vehicle is fully loaded or an axle GAWR is reached. For tire size and inflation pressures, [see Specifications on page 4-3](#).

Proper front end alignment improves tire tread mileage. Your front-end suspension parts should be inspected periodically and aligned when needed. Improper alignment may or may not cause the vehicle to vibrate. However, improper toe alignment will cause front tires to roll at an angle, which will result in faster tire wear. Incorrect caster or camber alignment will cause your front tires to wear unevenly and can cause the vehicle to "pull" to the left or right.

Vehicle Placard and Tire Inflation Pressure Label

The TIRE AND LOADING INFORMATION placard supplies information on the size and the cold tire inflation pressure for the original equipment tires supplied with your vehicle. Check the Sprinter manual for all weights and tire information placard location.

A MOTORHOME TIRE SAFETY ADDENDUM is included with your Airstream owner's packet. Please take the time to read, understand, and follow the information contained in the booklet.

Proper Tire Inflation

The level of air in your tires affects your vehicle's overall performance. Not even the highest quality tire will perform well if it's not inflated properly. The correct pressure varies from vehicle to vehicle and depends in part upon driver preference. Each vehicle has a recommended inflation pressure, usually found on a placard. Check the Sprinter manual for all weights and tire information and the placard location.

Correct tire inflation is a key component in tire care. The recommended inflation pressures for your tires are indicated on the certification label or in your owner's manual. Since touring coach's can be loaded with many different configurations, the load on each tire will vary. For this reason, air pressure should be checked based on the load on each individual tire. Cold Inflation Pressure should be adjusted to handle the maximum tire load, and all tires on the axle should carry the same inflation pressure. Cold tire inflation pressure is the tire pressure checked in the morning before you drive more than a few miles or before rising ambient temperatures or the sun's radiant heat affect it. Check your tire air pressure at least once a month, before each trip, and each morning you drive during a trip. Tire pressure should be checked cold, as tire pressure ratings have been designed with typical running heat/pressure build up in mind. Make sure the valves and caps are free of dirt and moisture.

Underinflation

Underinflation brings a higher risk of susceptibility to damage due to road hazards, reduces tire casing durability, and causes a loss in fuel economy, plus uneven or irregular tire wear. Severe under inflation brings about an increased risk of tread separation, handling difficulties, and possibly tire failure, which is caused by overheating.

⚠ WARNING

It is a common practice for motorhome owners to lower tire pressure in their search for a smoother ride. This is not only dangerous, it is relatively ineffective, and the difference in ride quality is not significant. When minimum inflation pressure requirements are not met, tire durability and optimum operating conditions are compromised. Tire inflation pressure should always meet at least the minimum guidelines for vehicle weight.

- It may be necessary to inflate your tires at a truck stop or truck service center in order to achieve adequate air pressure for your coach's needs
- Only permanent air seal metal valve caps should be used.
- Be safe - if a tire has been run 20 percent under inflated, it must be dismantled and inspected by a trained professional. It should not be inflated without a full inspection or without using a safety cage. Use a calibrated gauge. If your tire is rated for higher inflation pressures, a special gauge designed for larger tires will be required.

⚠ WARNING

Due to RISK OF EXPLOSION damaged tires or tires run with more than a 20% underinflation (approximate) must be dismantled, inspected by a trained professional, and should not be inflated without using a safety cage.

- Don't bleed air from warm tires to reduce pressure buildup.
- Don't inflate tires to cold psi rating beyond rim specifications.

How Overloading Affects Your Tires

Tire pressure is what enables your touring coach tire to support loads. Overloading your tires can have serious consequences for passengers and your touring coach. Too much weight can cause stress on your touring coach's suspension system, brake failure, shock absorber damage, handling and steering problems, irregular tire wear and possible tire failure. Excessive loads or under inflation can lead to an excessive amount of heat and tire failure. If you discover that your tires cannot handle the load, lighten the weight of the load on your tires.

Tires and Wheels

(This section is partially excerpted from the Mercedes-Benz Sprinter Van Operator's Manual.)

Check tires regularly for even tread wear, tread depth (note legal requirements), and signs of external damage. Use only wheels and tires of the same size, make, and pattern.

Do not install tires that are not approved for the size and type of wheel installed on the vehicle itself. Only use those wheel sizes that were delivered to you by your authorized Mercedes-Benz Sprinter dealer.

Use only wheels and tires that have been tested and approved by the vehicle manufacturer.

Break in the tires at moderate speeds for a distance of about 65 miles.

⚠ WARNING

Always replace wheel nuts that are damaged or rusted. Never apply oil or grease to wheel nuts. Damaged wheel hub threads should be repaired immediately. Incorrect mounting bolts or improperly tightened mounting bolts can cause the wheel to come off. This could cause an accident. Make sure to use the correct mounting bolts. Check tightness of wheel nuts regularly and retighten if necessary.

Tire Grip

Tire grip is greatly reduced on a wet or icy road. Speed and driving style must therefore be adapted to suit road conditions. Below a tread depth of 1/8 in., tire grip begins to decrease rapidly on wet roads.

Hydroplaning

Depending on the depth of the water layer on the road, hydroplaning may occur, even at low speeds and with new tires. Reduce vehicle speed, avoid grooves in the road, and apply brakes cautiously in the rain.

The majority of flood-related deaths are caused by people attempting to drive through moving water. Driving into flood waters may be the most dangerous thing one might ever try. Considering the following:

- Most cars will float (and be swept away) in 18-24 inches of moving water. Trucks and SUVs have only 6-12 more inches of clearance. Creeks and rivers can rise very rapidly and the road bottom can also wash away, making the water much deeper than it appears.
- Once cars are swept downstream, they will often roll to one side or perhaps flip over entirely. The driver has a few seconds to escape the vehicle. Many drivers panic as soon as the vehicle submerges and are found later with their seat belt intact.

Changing A Tire

(Partially excerpted from the Mercedes-Benz Sprinter Van Operator's Manual)

After changing a wheel, the wheel nuts must be tightened once the vehicle has been driven for about 30 miles.

If new or repainted wheels are fitted, the wheel nuts must be retighten again after about 600 to 3000 miles. Do not use remolded tires.

⚠ WARNING

Fitting wheel sizes other than those supplied by Sprinter to the vehicle will change the Sprinter's handling characteristics and may lead to an accident resulting in severe personal injuries, death and property damage.

⚠ WARNING

Read the Sprinter manual for wheel bolt or lug nut torque and wheel tightening procedures.

⚠ WARNING

The Mercedes-Benz Sprinter Operator's Manual contains important cautions, warnings, specifications, and operational information on changing, maintaining, and replacing of the tires and wheels. Read, understand, and follow the Sprinter manual sections for changing a tire.

⚠ CAUTION

Changing a tire on a touring coach chassis is a physically demanding procedure. It requires specialized tools and knowledge of safety procedures. Only you can determine your knowledge base and physical ability. Don't take any unnecessary risks. Find a safe area to park your coach, and call a tire service center and supply them with the information in the Sprinter Manual if you have any doubts about changing a tire.

Flat Tire

If you get a flat tire while driving, gradually decrease your speed. Hold the steering wheel firmly and slowly move to a safe place on the side of the road. The pressure of the spare wheel (sold separately) should be checked regularly (at least after every tenth time at the filling station).

The vehicle tool kit is located in a hatch under the front passenger foot well.

⚠ WARNING

Use a jack (sold separately) designed exclusively for jacking up the vehicle at the jack take-up brackets built into either side of the vehicle. To help avoid personal injury, use a jack only to lift the vehicle during a wheel change. Never get beneath the vehicle while it is supported by a jack.

Precautions When Changing a Wheel

- Keep hands and feet away from the area under the lifted vehicle.
- Always firmly set parking brake and block wheels before raising vehicle with jack.
- Do not disengage parking brake while vehicle is raised.
- Always use the jack on a level surface.
- Do not jack the vehicle up more than 1-2 in. between the tire and the surface. Otherwise, the vehicle may tip over and may cause serious injury or death to you or others.
- Be sure that the jack arm is fully seated in the jack take-up bracket.
- Always lower the vehicle onto sufficient capacity jack stands before working under the vehicle.
- Do not damage, grease, or oil wheel nuts or stud threads.

Procedure

- Park the vehicle on a firm, level, non-slippery surface.
- Switch on the hazard warning flasher switch, apply the parking brake, and place the transmission selector in “P”.
- Everyone must leave the vehicle before you jack it up.
- Everyone must leave the danger zone before you jack up the vehicle. Danger zones vary with locations. Take a minute and look at what might happen if the vehicle falls off the jack and rolls. Set up your danger zone.
- The vehicle must be safeguarded in accordance with legal regulations (such as using a warning triangle).
- Prevent vehicle from rolling away by blocking wheels with wheel chocks (not supplied with vehicle) or sizable woodblocks or stone. On a level road place one chock in front of and one behind the wheel that is diagonally opposite to the wheel being changed. When changing a wheel on mild uphill or downhill grade, place chocks on the downhill side blocking both wheels of the other axle. Do not jack vehicle up on a steep grade.

 WARNING

Do not change wheels on a steep uphill or downhill grade. The vehicle may begin to move and fall from the jack, which could cause property damage, personal injury, and/or death.

Jack

Read, understand, and follow the Mercedes-Benz Sprinter Operator’s manual instructions, cautions, and warnings for changing a wheel and jack point locations.

- Loosen the wheel nuts before raising the vehicle.
- Close the release valve on the jack.
- Assemble the pump lever provided and insert it into the socket on the jack.
- Secure lever by turning it clockwise in the socket.
- Position the jack under the appropriate jack point and raise the vehicle by pumping the lever.

 WARNING

A jack (sold separately) is intended only for raising the vehicle briefly, for instance when changing a wheel. The jack must be placed on a firm, flat surface only. Do not crawl under the vehicle while it is raised with a jack. Do not start the engine while the vehicle is jacked up. Do not jack the vehicle up more than 1-2 in. between the tire and the surface. The vehicle may tip over and cause serious injury or death to you or others. Jack stands must always be used while working beneath the vehicle. Failure to follow these precautions could result in property damage, personal injury, and/or death.

Installing and Removing A Wheel

- Loosen the wheel fasteners (wheel bolts or lug nuts).
- Jack up the vehicle until the wheel is clear of the ground.
- Unscrew the fasteners and remove the wheel (keep the fasteners clean).

⚠ WARNING

If the vehicle moves forward or backward while it is being jacked up, lower it, stabilize the vehicle, and repositioned the jack. When the vehicle is jacked up, the jack must stand vertically (plumb-line).

Mounting a New Wheel

- Before fitting the spare wheel, clean rust and dirt off the contact surfaces of the wheel and the wheel hub and from wheel bolts or lug nuts.
- Note the specified wheel and tire size, tire load capacity, and speed code.
- Do not change the tire's direction of rotation.
- Do not damage, grease, or oil wheel bolts or lug nuts or their threads.

Centering Wheels With Wheel Fasteners

- If dual assemblies are used, before placement, the inner wheel should be inspected to ensure all ball bearing rings are in the proper position.
- Install the wheel and snug the wheel fasteners.
- Slightly tighten wheel fasteners.

Lowering the Vehicle

- Slowly open the jack release valve to lower the vehicle until tire is resting on the ground.
- Tighten the wheel fasteners in a crisscross pattern, as specified, with a torque wrench. For wheel fastener torque procedures, see the Mercedes-Benz Sprinter Van Operator's Manual.
- Remove the jack and stow.
- Check the tire pressure. For tire pressures see the vehicle manufacturing tag on the driver's door jamb of your touring coach; also [see Specifications on page 4-3](#).
- Torque wheel fasteners immediately after reinstalling a wheel and again after 30 miles.

⚠ WARNING

Only certain tires meeting the tire size/load/speed index ratings contained in the Tire Pressure Tables, found in the Index Section of the Mercedes-Benz Sprinter's Operators or Owner's Manual, are certified to conform to FMVSS 120 for the Sprinter Vehicle at this time. Please check the sidewalls of your originally-equipped tires for specific makes/sizes, and speed load ratings when you need to replace your tires. To prevent accident, injury, or possible death, use only the correct tires for your tire replacement.

Wheel Bolt/Lug Nut Tightening

Torque wheel fasteners evenly to specification with a torque wrench using a crisscross pattern in the proper sequence:

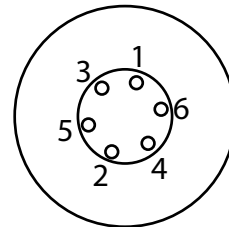

⚠ WARNING

Consult the Mercedes-Benz Sprinter Operator's manual for extensive wheel installation, tightening, torque procedures, cautions, and warnings.

⚠ WARNING

Wheel fastener torque must be checked immediately after reinstalling a wheel and again after 30 miles. Torque all wheel fasteners evenly to specification using the proper sequence. For torque values, [see Specifications on page 4-3](#).

⚠ WARNING

Tightening by hand or with an impact wrench can result in loose or overtightened wheel fasteners, which could lead to a wheel falling off while driving or damage wheel and brake components.

Tire Rotation

Front and rear tires perform different jobs and can wear differently depending on the types of roads driven, driving habits, etc. To obtain the longest tire life, you should inspect and rotate your tires regularly.

Many automotive dealers and tire dealers will perform a free tire inspection to look for uneven or abnormal tire wear.

Tires should be rotated every 6,000 to 8,000 miles. For the longest tire life, any time irregular wear is seen have the tires checked, alignment checked, and tires rotated by your truck or tire dealer. Have the cause of uneven wear corrected.

Typical Tire Rotation Patterns

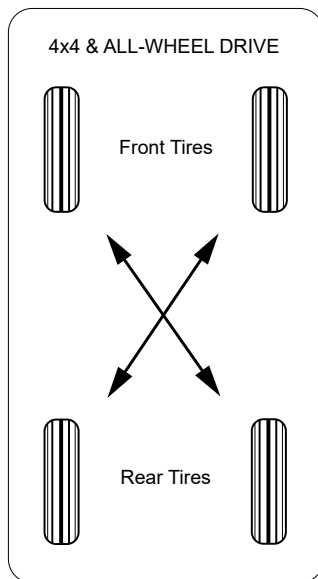

⚠ WARNING
 Read, understand, and follow the Sprinter manual sections for Tire Rotation and the Tire Pressure Monitoring System reset functions.

⚠ WARNING
 Front and rear tires are inflated to different pressures. Tire pressures must be adjusted to the proper levels after rotation; see Specifications on page 4-3.

Support

Since touring coach's may sit for long periods it is important to properly support the tires if blocks are used for leveling.

Extreme caution must be taken to ensure that the tires are fully supported when using blocks to level the touring coach. The load on the tire should be evenly distributed on the block. If not done, the steel cables in the sidewall of the tires may be damaged and could lead to premature fatigue of the sidewall.

Correct

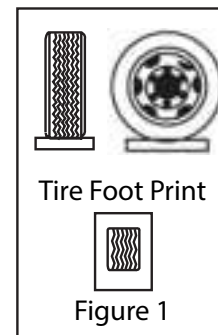

The CORRECT method is shown in Figure 1. The tire is supporting the full load. Please note that the block is wider than the tread and longer than the tire's footprint. This provides maximum support to the tire and ensures that the load is evenly distributed throughout the tire's footprint area.

Incorrect

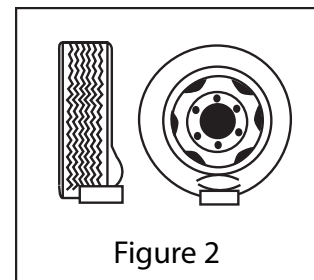

INCORRECT method is shown in Figure 2: A portion of the tire is supporting the full load.

⚠ WARNING
 Tires that are incorrectly supported may be damaged, which could lead to casing failure resulting in serious injury or property damage. If, on previous occasions, the tires have been incorrectly supported, hidden damage may be present. Please contact your local tire dealer and request an inspection and a determination of possible damage.

AIRSTREAM®

Section 8 DRIVING

LOADING	8-2	TOWING A TRAILER	8-6
Weighing	8-2	Towing a Boat	8-6
Vehicle and Trailer Weights and Ratings Definitions	8-2	Tracking	8-6
Procedure for Weighing a Touring Coach	8-3	Brake Controller	8-7
Weight Distribution	8-3	Backing Up	8-8
SAFETY	8-4	Camera Monitoring System (360°)	8-8
Seat belts	8-4	Passing	8-8
TRAILER TOWING AND DRIVING TIPS	8-4	Parking Your Touring Coach	8-9
Trailer Hitches	8-4	TOWING YOUR TOURING COACH	8-9
Loading a Trailer	8-5	SAFETY CHECK LIST	8-9
Checking Weights of Vehicle and Trailer	8-5	Exterior Check List (Before Entering Vehicle)	8-9
Attaching a Trailer	8-5	Interior Check List (Before Driving)	8-10

Loading

One of the most critical aspects of safely operating a touring coach is knowing the weight involved and where it is placed. The first thing to determine is how much cargo is being loaded and confirming that it is within the capacity of the equipment being used. Determining WHERE that load is placed is critical to the way your rig will handle on the road.

Do not try to guess what your touring coach weighs loaded. Load your touring coach including water and take it to a public scale. Weigh each axle of your vehicle. Refer to your axle weight and tire limits to see if you are within a safe range. Total all axle weights and make sure you are below the GVWR. If you are not overloaded, make sure your load is balanced. Do not load too much on one side. A balanced load is much easier to tow or drive.

Front to back balance is also important. Step back and look at your touring coach. Make sure there is not too much weight in the front or on the rear of the touring coach. Be sure to secure all items. Loose items can cause damage and can be a safety issue.

The Cargo Carrying capacity tag shown below is installed on every touring coach and can be found on the inside of the door on your vehicle.

MOTOR HOME OCCUPANT AND CARGO CARRYING CAPACITY
VIN #####
THE COMBINED WEIGHT OF OCCUPANTS AND CARGO SHOULD NEVER EXCEED
XXX kg or XXX lbs
Safety belt seating capacity:XXX
CAUTION
A full load of water equals XXX kg or XXX lbs of cargo @ 1 kg/L (8.3 lb/gal) and the tongue weight of a towed trailer counts as cargo

To arrive at “THE COMBINED WEIGHT OF OCCUPANTS AND CARGO SHOULD NEVER EXCEED” number, Airstream weighs the vehicle as finished and adds the weight fuel. That number is subtracted from the GVWR of the touring coach and listed on the tag, The total weight of any and all cargo, including but not limited to dealer or customer modifications or additions, fluids (fresh water and holding tanks), food, clothes, tools, tongue weight of a towed trailer or vehicle, and passengers should never exceed the number listed while the touring coach is in transit.

The “SAFETY BELT SEATING CAPACITY” is the number of passengers that seat belts are provided for.

The “A FULL LOAD OF WATER EQUALS” number is arrived at by multiplying the fresh water tank and water heater capacities by 1Kg/L or 8.34 lb/gal.

When loading the vehicle it is important to keep the GVWR, GAWR, Tire Weight Ratings (listed on the vehicle tire Information placard), and the cargo and occupant capacity in mind and not to exceed these specifications. Your safety depends on not overloading the touring coach, axles, and tires; [see Specifications on page 4-3](#).

Weighing

To determine the actual weight of your vehicle with personal cargo and water, it must be weighed on scales as you plan to travel. The most common scales are those used by states to weigh trucks along the highway. In rural areas, grain elevators, cement outlets and gravel pits are a good source.

NOTE

Weighing instructions for this touring coach are explained on the next page. If you have trouble locating scales, a call to your State Highway Patrol will usually find them cooperative in assisting you.

Vehicle and Trailer Weights and Ratings Definitions

Gross Vehicle Weight Rating (GVWR) is the maximum permissible weight of the touring coach.

Gross Vehicle Weight (GVW) comprises weight of vehicle including tools, installed accessories, passengers, cargo, and trailer tongue weight. It must never exceed the GVWR.



Gross Axle Weight Rating (GAWR) is the maximum permissible axle weight.

Gross Trailer Weight (GTW) is the maximum permissible trailer weight to be towed.

Trailer Tongue Weight Rating (TWR) is the maximum permissible weight of the trailer tongue. This counts as cargo when loading a touring coach.

NOTE

Check the Sprinter manual for all weights and the tire information placard location.

Front Axle GAWR	GVWR	Rear Axle GAWR	GCWR - GVW
SCALE WEIGHT		Optional Tow Weight	
			
STEP 1 Front Axle GAW	STEP 2 GVW	STEP 3 Rear Axle GAW	STEP 3a Tow Weight minus Weight of Trailer or Vehicle Towed
INDIVIDUAL WHEEL POSITION WEIGHT			
			
STEP 4 Left Front Wheel Position	STEP 5 Left Side (Total LF + LR)	STEP 6 Left Rear Wheel Position	
Calculated	Calculated	Calculated	
Right Front Wheel Position Step 1 minus Step 4	Right Front (Total RF + RR) Step 2 minus Step 5	Right Rear Wheel Position Step 3 minus Step 6	

GAWR = Gross Axle Weight Rating
 GVWR = Gross Vehicle Weight Rating
 GCWR = Gross Combination Weight Rating

Procedure for Weighing a Touring Coach

Vehicle should be weighed loaded, as you normally travel.

1. Fill in first row from Specification Section of this manual.
2. Weigh vehicle as shown in row 2 (Scale Weight) and fill in blanks.
3. Weigh one side of vehicle as shown in Individual Wheel Position Weight.
4. Calculate other side as shown in last row.

Weight Distribution

Touring coach's have fresh water and gray water tanks, a heating and hot water system, and storage areas. It gives you great flexibility in loading. If you want to load down all the storage compartments, the amount of fluids may have to be reduced. Distribute your additional cargo as evenly as possible with the heaviest objects located as low as possible.

Even if you're going to a remote area, you can usually fill your water tank shortly before entering the area. Just reducing your load by 10 gallons of water lets you carry an additional 83.4 lbs. of cargo.

NOTE

Check the Sprinter manual for all weights and the tire information placard location.

Safety

Seat belts

Federally approved seat belts are provided for the use of the driver, passenger, and the rear sofa. Most states require, by law, that all passengers in a motor vehicle use seat belts while in transit. It is strongly recommended that all occupants remain seated with their safety belts firmly attached while the touring coach is in transit. The driver should adjust his or her seat so that he or she is able to reach all controls easily with the belt on, and be able to use all the travel on the foot brake. Seat belts should be placed as low as possible around the hips to prevent sliding out from under them in case of an accident. This places the load of the body on the strong hipbone structure instead of around the soft abdominal area. Remember, there should only be one occupant per seat belt when traveling.

The driver and front passenger seat belt buckle operation is explained in the Mercedes-Benz Sprinter manual.

The rear sofa buckles are secured by inserting the male end into the female buckle until the buckles are secured. To release the buckle press the release button on the female end.

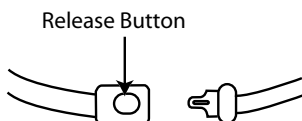

⚠ WARNING

Become familiar with and follow all directions, advice, and warnings pertaining to seats, seat belt operation, and restraint systems, provided in the Mercedes-Benz Sprinter Operator's Manual. Do not allow passengers to ride anywhere in the touring coach except in seats that are equipped with approved seat belts.

⚠ DANGER

Children must be secured in a federally-approved child restraint device. Failure to use proper restraints while in transit can result in severe or fatal injuries. Never place an infant seat that faces to the rear on the front passenger seat. Never place an unbelted infant seat on any seat while in transit.

Child restraint devices are designed to be secured with lap or lap/shoulder belts. All instructions supplied by the restraint manufacturer must be followed. Statistics have shown children are safer when properly restrained in a rear seating position than in a front seating position.

Don't hesitate when it comes to passenger safety. Make sure all passengers are properly restrained.

Trailer Towing and Driving Tips

(Some text is partially excerpted from Mercedes-Benz Sprinter Operators Manual.)

⚠ WARNING

Failure to use proper equipment and driving technique can result in a loss of vehicle control when towing a trailer. Improper towing or failure to follow the instructions contained in this section can result in serious injury. Follow the guidelines below carefully to assure safe trailer operation. Ask your authorized Mercedes-Benz Sprinter or Airstream dealer if you require an explanation of information contained in the manuals.

Trailer Hitches

Units have hitches and wiring installed from the Mercedes-Benz manufacturer. The Sprinter 7-way connector is used for lights and charge line on a trailer. For further information, please see your authorized Mercedes-Benz Sprinter dealer.

To reduce the possibility of damage, remove the hitch ball adapter from the receiver when not in use.

Since this vehicle is designed and intended primarily as a load-carrying vehicle, towing a trailer will affect handling, durability and economy. Maximum safety and satisfaction depends upon proper use of correct equipment and avoiding overloads and other abusive operation.

⚠ WARNING

The total weight of the touring coach and trailer must not exceed the GCWR listed in the specification section of this manual. The maximum towing capacity varies according to the size of the touring coach and its GCWR. Vehicles should be properly equipped for towing trailers. Information on trailer hauling capabilities and special equipment required may be obtained from your Mercedes-Benz Sprinter and/or Airstream dealer.

Loading a Trailer

When loading a trailer, you should ensure neither the permissible GTW (Gross Tongue Weight), nor the trailer GVWR are exceeded.

Maximum permissible values are listed on the safety compliance certification labels for the vehicle and for the trailer to be towed. For their location, see the Mercedes-Benz Sprinter Operator’s Manual. The lowest value listed must be selected when determining how the vehicle and trailer are loaded.

To assist in attaining good handling of the vehicle/trailer combination, it is important that the tongue weight be maintained at approximately 10-15 percent of the loaded trailer weight, but not to exceed the hitch rating. Tongue loads can be adjusted by proper distribution of the load in the trailer, and can be checked by weighing separately the loaded trailer and then the tongue.

The tongue weight at the hitch ball must be added to the GVW to prevent exceeding your Sprinter towed vehicle’s rear GAWR.

When towing trailers, touring coach tires should be inflated to the highest pressures shown on the Sprinter Tire Information Placard. See Mercedes-Benz Sprinter Operator’s Manual for its location. The Cargo Carrying Capacity (CCC) of this vehicle is reduced by the amount that equals the trailer tongue load on the trailer hitch.

Checking Weights of Vehicle and Trailer

To assure that the tow vehicle and trailer comply with the maximum permissible weight limits and to know the actual weights, have the loaded vehicle-trailer combination (tow vehicle including driver, passengers, cargo, and trailer fully loaded) weighed on a commercial scale as explained earlier in this section.

Also, check the vehicles front and rear axle weights and tongue weight. The values as measured must not exceed the Sprinter weight ratings listed on vehicle information placards and in the Mercedes-Benz Sprinter manual. These ratings are also listed in section 4 - Floor Plans, Specification Chart of this manual.

NOTE

Check the Mercedes-Benz Sprinter manual for all weights and tire information placard locations.

Attaching a Trailer

Please observe maximum permitted trailer dimensions (weight and length).

Most states and all Canadian provinces require safety chains between your tow vehicle and trailer. The chains should be crisscrossed under the trailer tongue. They must be attached to the hitch receiver and not to the vehicles bumper or axle. Be sure to leave enough slack in the chains to permit turning corners.

Most states and all Canadian provinces required a separate brake system for towing trailers.

⚠ WARNING

The towing vehicle’s braking system is rated for operation at GVWR, NOT at the GCWR. A separate, functioning brake system is required for any towed vehicles or trailers weighing more than 1000 lb (450 kg) when fully loaded. NEVER exceed the GVWR, or the GAWR specified on a touring coach certification label. Also, NEVER exceed the weight ratings of a trailer hitch installed on a touring coach. Failure to heed any part of this warning could result in loss of control of the touring coach and towed vehicle or trailer which may cause an accident and serious injury. For specified towed vehicle braking requirements, consult the Mercedes-Benz Sprinter Operator’s Manual that comes with this vehicle.

⚠ WARNING

Do not connect a trailer brake system (if trailer is so equipped) directly to the vehicle’s hydraulic brake system if your vehicle is equipped with anti-lock brakes. If you do, neither the vehicle’s brakes nor the trailer’s brakes will function properly. Property damage, injury, or death to you or others may be the result.

The provided vehicle electrical wiring harness for trailer towing has a brake signal wire for hookup to a brake controller. Most states and all Canadian provinces require a breakaway switch on trailers with a separate brake system. The switch activates the trailer brakes in the possible event that the trailer might separate from the tow vehicle. Please consider using a trailer sway control system. For further information, see your authorized Mercedes-Benz Sprinter or Airstream dealer.

Towing a Trailer

There are many different laws, including speed limit restrictions, having to do with trailer towing. Make sure that your vehicle-trailer combination will be legal not only for where you reside, but also for where you'll be driving. A good source for this information can be the State Attorney General, State Police, or local authorities.

Before you start driving with a trailer, check the trailer's hitch, breakaway switch, safety chains, electrical connections, lighting, and tires. Also, adjust the mirrors to permit an unobstructed view beyond the rear of the trailer.

If the trailer has brakes using an electric brake controller, start your vehicle and trailer moving slowly, and then apply the brakes manually using the brake controller to be sure the brakes are working properly. Read and follow the controller manufacturer's recommendations.

When towing a trailer, check occasionally to be sure the load is secure, and lighting and trailer brakes (if so equipped) are functioning properly. Always secure items in the trailer to prevent load shifts while driving.

Take into consideration that when towing a trailer, the handling characteristics are different and less stable from those when operating the vehicle without a trailer. It is important to avoid sudden maneuvers.

The vehicle and trailer combination is heavier, and therefore is limited in acceleration ability and requires longer stopping distances. It is more prone to reacting to side wind gusts, and requires more sensitive steering input.

In order to gain skill and an understanding of the vehicle's behavior, you should practice turning, stopping and backing up in an area which is free from traffic.

If possible, do not brake abruptly, but rather engage the brake slightly at first to permit trailer to activate its brake. Then increase the braking force.

We want every owner to be a safe and courteous driver. A few hours of towing practice in a large empty parking lot will make pulling your trailer over the road much easier. Line out two corners for left and right turns. You may also use these corners to practice backing and parking.

Towing a Boat

While it is possible to tow a boat with your touring coach, Airstream does not recommend it. If you plan to pull and launch a boat, use caution when backing down boat ramps, and do not submerge any part of your touring coach in water. The slope of some boat ramps may be lower than others, requiring a portion of the tow vehicle to be submerged when launching. While this may be okay for some vehicles, your touring coach has sensitive electronics that water infiltration would irreparably damage.

NOTICE

It is imperative that you do not allow any part of your touring coach to be submerged in water as it could cause damage to electrical components that a warranty would not cover.

Tracking

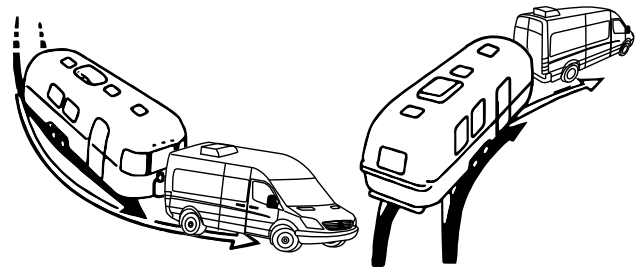

During practice, observe that the tracks made by the trailer wheels are distinctly different from those made by the tow vehicle. Studying this will make it easier for you to correct mistakes. Consider truck- or trailer-type fender or door grip rear view mirrors for maximum visibility. In most states, the law requires them.

After thoroughly inspecting your hitch, brakes, and tires, you should be ready to tow. Check traffic, signal that you are about to pull away, and start slowly. Look often in your mirrors, observe the action of the trailer, and then carefully move into the proper lane of traffic. Remember that the trailer wheels will not follow the path of the tow vehicle wheels; therefore, wider turns are necessary when turning to the left or right.

On freeways or expressways, try to pick the lane you want and stay in it. Always maintain plenty of space between you and the car ahead, at least the length of the tow vehicle plus trailer for every 10 mph. Remember that in order to pass another vehicle, you will need longer to accelerate. You must also allow for the length of the trailer when returning to the right hand

lane. On a two-lane road cars may be lining up behind you because you are traveling at a lower speed. It is both courteous and sensible to signal and pull over at the earliest safe opportunity and let them pass.

⚠ WARNING

Take into consideration that when towing a trailer, the handling characteristics are different and less stable from those with operating the vehicle without a trailer. It is important to avoid sudden maneuvers. Sudden maneuvers may lead to loss of control over the vehicle-trailer combination.

Brake Controller

The brake controller (if so equipped) is activated when you apply the brakes of the tow vehicle. Your tow vehicle brakes will automatically apply the trailer brakes first when properly adjusted. This will help keep your tow vehicle and trailer in a straight line and make you stop as if you were driving the tow vehicle alone. If swaying or swerving should occur, briefly operating the controller separate from the vehicle brakes may help correct the situation. Practice this maneuver on a clear highway. Do not wait for an emergency and then grope for the controller.

When towing a trailer, you might encounter a temporary cooling system overload during severe conditions such as hot days when pulling on a long uphill grade, when slowing down after higher speed driving, or driving long idle periods in traffic jams. If the hot indicator light comes on, or the temperature gauge indicates overheating and you have your AC turned on, turn it off. Pull over in a safe place and put on your emergency brake. Don't turn off the engine. Increase the engine idle speed. Lift the engine hood and check for fluid leaks at the radiator overflow outlet. Check to see that all drive belts are intact and the fan is turning. If you have a problem have it fixed at the next opportunity. If there is no problem the light should go off or temperature should come down within one minute. Proceed on the highway a little slower. Ten minutes later resume normal driving.

NOTICE

If the transmission continually shifts between gears on inclines, manually shift to a lower gear. A lower gear and reduction of speed reduces the chances of engine overloading and/or overheating. When going down a long hill, shift into a lower gear and use the engine's braking effect. Avoid riding the brakes, thus overheating the vehicle and trailer brakes. If the engine coolant rises to an extremely high temperature (e.g. coolant temperature needle approaching the red zone) when the AC is on, turn off the AC. Engine coolant heat can be additionally vented by opening the windows, switching the climate control fan speed to high and setting the temperature control to the maximum hot position.

⚠ WARNING

Never open a radiator cap when the tow vehicle is hot. Add coolant when the vehicle is cool.

⚠ WARNING

On slippery pavement, do not use engine drag to help slow down as this may cause the rear wheels of the tow vehicle to skid. On icy pavement, drive slowly and if you feel the tow vehicle skidding, gently apply the trailer brakes only. This will bring the tow vehicle and trailer back into a single line. Chains do not help trailer wheels.

When going downhill in dry weather, downshift so that engine compression will slow the whole rig down. Take dips and depressions in the road slowly and do not resume normal driving speeds until you are sure that the trailer wheels are clear of the dip.

When driving in mud and sand, let the momentum carry the rig through. Apply power gently and use as little as possible. Stay in the tracks of the vehicle ahead and keep the tow vehicle in the highest possible gear. If you are stuck, it is best to tow out the entire rig together without unhitching.

Despite even the best hitch, you will notice that whenever a large bus or truck overtakes your rig the displaced air first pushes the trailer rear slightly to the right and then affects the front. It may be necessary to steer very slightly, momentarily, toward the bus or truck to help compensate for the sway induced by the passing-vehicle. Do not apply the vehicle brakes, as this can tend to exaggerate the situation. You may find, however, that briefly applying the trailer brakes with your manual control will help eliminate sway.

⚠ WARNING

CHOCK THE TRAILER WHEELS when stopping on a hill or slope. Leaving your tow vehicle in gear is not enough for standstill safety. Do not use trailer brakes as parking brakes.

Backing Up

In BACKING UP the important thing to remember is to DO EVERYTHING SLOWLY and to correct immediately if you see the trailer turning the wrong way. Concentrate on the rear of the trailer. With your tow vehicle and trailer in a straight line, back up slowly and turn the bottom of the steering wheel in the direction you want the trailer to go. Watch from the window or in the mirror until the rear of the trailer is pointing in the desired direction. Your tow vehicle will be following the trailer in an arc. Straighten the tow vehicle and trailer by turning the steering wheel more sharply, and then when they are in line, straighten the steering wheel.

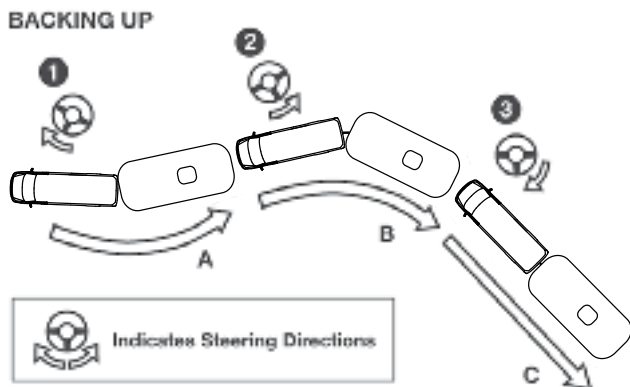

Start in position (A) start. Turning steering wheel as shown in (1). will put you in trailer position (B). Turning steering wheel show in position (2) puts you in trailer position (C). Steering position (3) returns front wheels to straight backing.

NOTICE

Always try to back to your left because the visibility is much better.

When you do not make it on the first try it is usually much easier to pull forward to your original straight position and start over.

If your spouse or traveling companion normally directs you when backing they should position themselves forward of the tow vehicle so the driver can easily see them. Their directions should always indicate to the driver the direction the rear of the trailer should go. A little practice in a parking lot with the person giving directions can save a lot of frustration when backing into a campsite.

Camera Monitoring System (360°)

Central to the dashboard is an LCD monitor that displays a 360° live video feed from cameras that are located on all four sides of the Interstate's exterior. These cameras provide video coverage of the vehicle's immediate surroundings. The system is controlled via touchscreen input and has a built-in speaker that provides audible warnings.

The system includes several features that provide supplemental information to the driver. These features are designed to assist you when operating the vehicle in a variety of situations, i.e., while parking or at exits with reduced visibility. Please always remain vigilant. This system is only intended to be used as an aid and is not meant to substitute safe and responsible driving.

⚠ CAUTION

Prior to operating, please refer to your Mercedes Benz Sprinter manual (provided in your owner's packet) for detailed instructional guides and system limitations.

Passing

Extreme care must be exercised when passing another vehicle. A vehicle with a trailer attached will require additional passing distance than when driving without a trailer. Because your vehicle and trailer is longer than your vehicle alone, you will also need to go much further ahead of the passed vehicle before you can return to your lane.

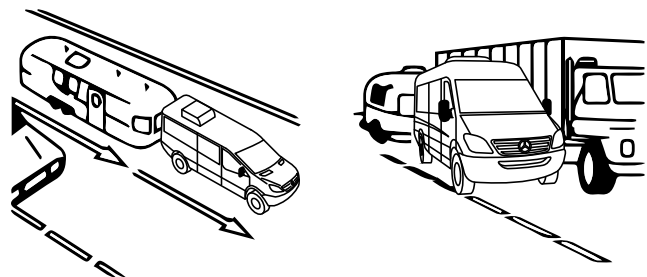

Parking Your Touring Coach

To reduce the risk of personal injury or damage to the vehicle power train as a result of vehicle/trailer movement, always:

- Keep right foot on the brake pedal.
- Shift gear selector lever to position “N”.
- Have a second person place wheel chocks on downhill side of left and right trailer wheels.
- Slowly release the brake pedal allowing the vehicle and trailer to roll into chocks until stopped.
- Press the electronic parking brake button, to the left of the steering wheel.
- Move gear selector lever to position “P”.
- On inclines, turn wheels toward the road curb.

Towing Your Touring Coach

See the Mercedes-Benz Sprinter Operators Manual for towing information.

<p>⚠ WARNING</p>
<p>Considerable damage may occur if the touring coach is improperly lifted for towing purposes. Only qualified professional towing service companies with proper equipment should be used. Observe all cautions and warnings in the Mercedes-Benz Sprinter Operator’s Manual before towing your touring coach.</p>

Safety Check List

Your Airstream Touring Coach should be given a thorough safety check before a trip. Regular use of the following list will provide safe operation of your touring coach and will help you spot any malfunctioning equipment and correct the problem as soon as possible. The list is to help you and may not be all-inclusive.

<p>⚠ WARNING</p>
<p>Failure to heed the following items may cause damage to the vehicle or personal injury.</p>

Exterior Check List (Before Entering Vehicle)

1. Check condition of tires and keep tires at recommended inflation pressure per the tire and loading placard on the driver’s door B-pillar.
2. Check that macerator hose, city water hookup, TV cable/satellite, power cord, and all exterior components are unhooked and properly stowed.
3. Check that all external compartments and filler openings are properly closed, latched, and/or locked.
4. Check that items stored on exterior of vehicle are securely tied down.
5. Verify if any items stored on exterior of vehicle would present a clearance problem.
6. Follow all automotive manufacturer’s recommendations on checking and filling fluid levels.
7. Check exterior lights and general condition of vehicle.

Interior Check List (Before Driving)

1. It is important that all doors be completely closed and locked during travel.
2. Turn off water pump and close all faucets.
3. Check that refrigerator door is closed and latched if equipped.
4. Check that nothing heavy is stored in overhead cabinets or open compartments, which could fall out and cause injury. Heavy items should be stored in lower cabinets.
5. Stow pedestal tables.
6. Stow cooktop.
7. Check that counter tops and shelves are clear of even small items that could become projectiles during an emergency braking or accident.
8. Do not cook unless the touring coach is parked and stable. Hot food or liquid could scald due to a sudden stop or accident while traveling.
9. Check that any internal stowage is securely held in place
10. Check that lights and switches are set in positions safe for travel.
11. Adjust the driver's seat so that you can easily reach and operate all controls. Make sure seat is locked in position. Do not adjust driver's seat swivel or recline mechanisms while vehicle is moving. The seat could move unexpectedly causing loss of control.
12. Check that all passengers have seat belts on properly.
13. The freedom of movement of the brake and accelerator pedals must not be impaired in any way.
14. Check rear view mirrors adjustment, inside and outside. Adjust window coverings if necessary for maximum visibility.
15. Secure children in a federally-approved child restraint device.

AIRSTREAM®

Section 9 MAINTENANCE

MAINTENANCE SCHEDULE	9-2	WINTERIZING AND STORAGE	9-8
AIRSTREAM SERVICE AND PARTS	9-3	Component Locations for Winterization	9-9
TIRE CARE	9-3	Winterization Procedure	9-9
Tire Care Tips	9-3	Instructions for Winterization	9-9
Tire Inspection and Storage	9-3	Optional-Additional Steps for Winterization	9-10
PLUMBING	9-4	Water Heater Maintenance and Winterizing	9-11
Water System (Self-Contained)	9-4	Macerator Pump Winterizing	9-11
Water Pump and Strainer	9-4	Vehicle Storage	9-11
Cleaning the Strainer	9-5	Restoring Service	9-12
Disconnecting the Strainer/Water Pump Lines.	9-5	Toilet	9-12
Sanitizing	9-5	Toilet Winterizing	9-12
DRAIN AND WASTE SYSTEM	9-6	Maintenance	9-12
Macerator Pump	9-6	ELECTRICAL DIAGRAMS	9-13
Emptying the Holding Tanks	9-7	12-Volt Main Schematic	9-13
Macerator Impeller Release Feature	9-7	30-Amp 120-Volt Schematic	9-20
Manual Operation	9-7	Audio and Video Schematic	9-21
Extended Stays	9-7	FRESH WATER LAYOUT	9-22
Waste Tank Flush	9-8	FAQS AND ANSWERS	9-23
Drain System Cleaning	9-8		

Maintenance

Maintenance Schedule

⚠ WARNING

Failure to maintain your touring coach can cause premature and unexpected parts breakage and/or erratic operation that may be hazardous.

NOTICE

See appliance manufacturer's literature for further information.

Every 1,000 miles or 60 days

Smoke and CO Detector	Test and replace battery as required.
Tires	Check tire pressure (See Specifications)
GFCI Circuit Breaker	Test and record.

Every 5,000 miles or 90 days

Wheel Fasteners	Torque to Specifications; see Specifications on page 4-3
7-Way Plug	Spray with contact cleaner.

Every 10,000 miles or 6 months

Tires	Inspect and rotate.
Windows, and Door Seals	Clean with mild detergent and apply 303 Aerospace Protectant
Exterior	Wax

Every year

Seams	Check and reseal exterior seams, windows, lights, and vents as needed.
Interior Cabinets	Visual Inspection of latches Locks, Hinges and Slides. Silicone Spray as needed.
Water Heater Pressure Relief/ Drain Valve	Operate manually to ensure water channels are clear; see Water Heater Maintenance and Winterizing on page 9-11.

Every 3 years

Water Heater Pressure Relief/ Drain Valve	Inspected by qualified technician; replace as necessary.
---	--

Mercedes-Benz Sprinter Van

Refer to your Sprinter Operator's Manual for important engine and vehicle maintenance intervals and adhere to onboard service notifications. Review the Sprinter manual's information and notes on maintenance, fuel grades, and Mercedes-Benz-approved operating fluids before refueling or servicing.

Airstream Service and Parts

Please contact an Airstream dealer service center to schedule maintenance and obtain replacement parts; see [Service Centers on page 3-5](#). Replacement parts for dealer service and repair and common items such as filters and hardware can be found in the parts book specific to your Airstream model.



Airstream parts books are posted on our website as soon as they're finalized, typically around the midpoint of model year production. Scan this QR code or visit <https://www.airstream.com> and navigate to the owner's section to locate the parts book for your model Airstream.



Airstream Supply Company is your trusted source for Airstream-approved cleaners, polishes, and other care products and supplies needed to properly maintain your Airstream's interior and exterior. Scan this QR code to visit and explore our assortment of RV care products and camping supplies at <https://airstreamsupplycompany.com>.

Tire Care

The most important function of tires is to provide traction while moving and grip when steering or stopping. The tires on your touring coach are designed for highway use and must be properly maintained in order to maximize tire life, as well to provide a safe mode of transportation. For information on changing a tire and tire inflation, see [Tires on page 7-4](#).

Tire Care Tips

To reduce the risk of tire failure, we strongly recommend the following:

1. Check the pressure in your tires, including your spare (not provided with vehicle), at least monthly when the tires are cool (after the vehicle has been stopped for 3 hours and then driven less than 1 mi). Do not reduce pressure when tires are hot. Use a tire gauge to check pressure and maintain it at the recommended level.
2. Never overload your tires. Heed the maximum load-carrying capability of your tires.
3. Check your tires frequently for scrapes, bulges, separations, cuts, or snags resulting from use. See your tire dealer immediately if any such condition is discovered.

4. Never operate your vehicle in excess of lawful speeds, the maximum speeds justified by driving conditions, or in excess of speeds recommended for the tires you are using.
5. Make every effort to avoid running over objects that may damage the tire through impact or cutting, such as chuck holes, glass, metal, etc.
6. Never drive on smooth tires. Tires should be removed when 2/32 in. of tread depth remains. In most states, it is illegal to drive with less than 2/32 in. remaining tread depth.
7. Park out of the sun whenever possible when in warm climates. In desert regions, use tire covers to prevent ultra violet light deterioration to tires.

Tire Inspection and Storage

Before taking your touring coach on a trip or when removing it from an extended storage period, make it a practice to inspect the overall condition of your tires. Check for any type of condition or damage that might result in failure. A thorough check should include both inside and outside sidewalls, tread area, and the condition of hardware such as valve stems, valve caps, and wheels. The tread should be checked for any unusual wear, cracking, penetrations, and/or cuts. An uneven wear pattern can indicate misalignment or worn suspension parts.

Since many touring coach's are used seasonally and sometimes stored for extended times, it is possible that tires will take many years to wear out. Tires, as any rubber product, will age over time. If tires show cracking in the sidewall or tread surfaces that are more than 2/32-in. deep, they should be replaced before your next trip or vacation. Store your touring coach in a cool, dry area away from major heat sources and extreme cold. An enclosed storage area is best with no exposure to electromagnetic sources such as generators or transformers. If you must keep your touring coach outside, cover your tires from direct sunlight. Take your touring coach to your tire dealer for service to check or correct any of these conditions.

 WARNING

Wheel fastener torque must be checked immediately after reinstalling a wheel and again after 30 miles. Torque all wheel fasteners evenly to specification using the proper sequence; see [Wheel Bolt/Lug Nut Tightening on page 7-8](#). For torque values, see [Specifications on page 4-3](#).

Plumbing

Water System (Self-Contained)

The fresh water system consists of a city water hookup, fresh water tank gravity fill, fresh water tank and drain valve, water pump, hot and cold water lines, water heater, fresh water line low point drain valves, and faucets. Full explanations on the locations and use of these features are explained in this section.

Before using the water system, check that the water heater's drain valve is closed and the water heater bypass valves are in the normal use position. Close all low point drain valves and close the fresh water tank drain valve. For valve locations, [see Component Locations for Winterization on page 9-9](#).

Fill the water tank by opening the main sliding door to access the gravity feed water fill cap. A high-pressure RV/Marine FDA approved drinking water hose of at least ½-in. diameter made from material that is tasteless, odorless, and non-toxic can now be inserted. It's a good idea to let the water run through a hose for a short time to flush it out. RVers sometimes fill their tanks with "home" water to avoid strange water that may be distasteful to them on short outings. Remember, the more water you carry in the Fresh Water tank, the less cargo carrying capacity you have for other items. The amount of water in the tank may be checked on the Multiplex Control Panel. Keep watch of the water level as the water fill is essentially on the interior of the unit.

Open the hot side of the galley faucet and turn on the water pump. For some time, the open faucet may only sputter. This is because the water heater is being filled and air is being pushed out through the lines. Once the water heater is full, a steady stream of water will flow from the faucet. Now, open a cold faucet. It may sputter for a short time, but will soon expel a steady stream. All other faucets can now be opened until all air is expelled. Once the system is filled with water and the faucets closed, the water pump will shut off. When a faucet is opened, the pump will come back on automatically. If the faucet is just barely open, it is normal for the pump to cycle on and off rapidly.

It is normal for a pump to occasionally cycle when all faucets are off to keep the water pressure at the set point. However, if it cycles frequently (e.g. more than a few times an hour) the plumbing system, pump, and pump strainer should be checked to be sure it is not losing pressure through a slow water leak or back through the pump.

NOTICE

To prevent equipment damage, the water heater should only be started after the water system is primed and ready for use.

NOTICE

Turn the water pump off when the touring coach is left unattended or in motion.

Water Pump and Strainer

The water pump and strainer are on the roadside interior, behind the lower front panel of the galley sink; to remove the panel, pull outward at the edge to release it from the catch grabbers holding it in place.

⚠ WARNING

The water pump is mounted near wiring and electrical components. Exercise caution to avoid electric shock or inadvertently disconnecting touring coach wiring when accessing the pump. Turn off all power using the battery disconnect and ensure all circuits in the vicinity of the pump are de-energized before accessing the pump.

The water pump is controlled by the Multiplex control panel. When turned on, the water pump's controller maintains a consistent regulated water pressure and steady water flow based on demand.

The water pump is typically left off when hooked up to a city water supply. However, if city water pressure is lower than desired the water pump can be turned on to facilitate increased water pressure, provided there is a supply of water in the fresh water tank. The tank will be depleted by the amount needed to supplement the flow of city water.

NOTE

If water flow is interrupted, check the water supply and turn the pump off and back on.



Cleaning the Strainer

Visually inspect it for accumulation of dirt/debris that could affect water flow and clean as needed:

1. Rotate the strainer housing to a position allowing access to the clear-view screen retainer and the tabs holding it in place.
2. Pinch the tabs inward to release the clear plastic retainer (as shown in the diagram).
3. Pull the retainer and screen out of the housing for cleaning. Rinse all debris from the screen.
4. Replace the screen assembly by aligning the screen in the seating grooves and pressing down gently until the tabs are back in place.

Disconnecting the Strainer/Water Pump Lines

The inlet and outlet hoses and the strainer assembly are held in place by self-sealing, blue, quick-connect fittings:

1. Grasp the blue tab on the female fitting by the grooved finger edges and pull straight out on the tab to release the male fitting.
2. Be sure that both the female and male fittings on the disconnect are free of all debris and damage before replacing them.
3. Check the pump system for leaks when reinstalling the disconnect fittings.

NOTICE

Failure to check the quick disconnect fitting for water leaks when reinstalling inlet and outlet hoses or the water pump strainer may cause the system to leak, causing damage to personal property.

Sanitizing

Airstream recommends sanitizing the fresh water system before and after storage, after installing new components, and whenever contamination is suspected. How often to sanitize—and what solution to use—depends on how frequently the RV is used, the taste and quality of the water, and the environments it has been exposed to, such as extreme heat, high humidity, or questionable water sources.

Use a sanitizer that effectively disinfects without damaging system components. While bleach is widely used for its ability to kill bacteria, viruses, fungi, and some protozoa, it can also corrode metal and degrade seals. In some configurations, susceptible components like the water heater cannot be bypassed, meaning the solution will circulate through the entire system. To avoid damage, Airstream generally recommends using an RV-specific fresh water system cleaner formulated to be safe for all fresh water system components. Follow the product's instructions for dilution and contact time.

If contamination is severe, bleach may be necessary. Refer to your water heater's manual for additional information. If bleach is not recommended, bypass the water heater whenever possible, and flush the system thoroughly when finished. Use the standard sanitization formula: 0.13 ounces of household bleach per gallon of water, or 1 milliliter per liter. This produces a 50 ppm free chlorine solution, consistent with RVIA ANSI A119.2 and widely accepted potable water disinfection practices.

Refer to the sanitization procedure that follows to introduce the solution into the system.

1. Determine the amount of solution you need for your fresh water tank's capacity; [see Specifications on page 4-3](#).
2. Pour a one gallon concentrate into the fresh water tank. Immediately fill the tank using a city water connection to dilute the concentrate to the proper sanitization ratio.
3. Open all faucets (hot and cold) allowing the water to run until the distinct odor of chlorine is detected.
4. Leave the solution in for the product's recommended contact time (4 hours for bleach). Drain the tank, refill from the city water connection, and drain again. Repeat until the solution is flushed out.

Drain and Waste System

Your touring coach has a Drain and Waste System, including holding tanks made from corrosion-free, molded plastic, and trouble-free dump valves. The waste water holding tank lets you use the toilet for several days before it needs emptying at an approved disposal facility.

Sink, shower, bath, and lavatory wastewater drain into the gray water holding tank. Wastewater from the toilet drains into the waste water holding tank. Each tank has a dump valve that drains through a common outlet so only one waste hose connection is needed when connecting to a disposal site.

Check your monitor panel frequently (main Multiplex control panel or Seelevel monitor). When the waste water holding tank is completely full, the toilet bowl cannot be emptied. If the gray water holding tank is overfilled, drain water will back up into the shower floor pan, resulting in unsanitary conditions.

CAUTION

Failure to monitor holding tank levels could result in unsanitary wastewater overflow.

Never drain the tanks at any place other than an approved dumping station. Almost all campgrounds will have a dump station. Park directories like Woodalls and Rand McNally list dumping stations, and the GPS navigation system may be able to locate nearby dumping stations or highlight stations along your route.

NOTICE

Do not use a pipe snake on clogged drains, as it could damage internal drain system components.

NOTICE

Never flush hard or solid objects, sanitary napkins, facial tissue, or paper towels down the toilet and into the holding tank. They will not macerate and will jam the dump valve and macerator pump impeller mechanisms.

NOTE

Colored toilet tissue is slower to dissolve than white. Most RV supply stores and some common retailers offer tissue designed for RVs that will completely dissolve.

Macerator Pump



The macerator grinds waste to a particle size of approximately 1/8" to pump all waste and tissue typically found in a recreational vehicle waste system.

The high-pressure waste hose used for emptying the waste water tank is stored on an motorized reel in a compartment on the roadside exterior. It has a threaded, drip-proof valve with a versatile, two-size threaded adaptor. The adaptor allows the valve to be connected to three sizes of threaded disposal inlets, including an exterior home sewer clean-out. The adaptor snaps over the valve threads. A rubber ring is also provided to lodge into a non-threaded inlet. Airstream recommends using a weight to secure the hose if the rubber ring is loose.

The roadside utility compartment above the hose compartment has individual switches for each holding tank, the macerator pump, and the hose reel. Each valve switch has a light that illuminates to indicate that the valve is open.

NOTICE

Do not run the Macerator pump dry for more than 30 seconds or run it continuously for more than 15 minutes. Doing so will damage the pump.

Emptying the Holding Tanks

1. Open the hose compartment door and pull out the high-pressure waste hose. Using the appropriate adaptor, secure the hose at the disposal inlet and verify that it is secure before turning on the pump.

⚠ CAUTION

If not properly secured, pump pressure may force the waste hose to disconnect while pumping wastewater, resulting in unsanitary conditions. Watch all connections while dumping. If a leak occurs, turn off the pump, close the dump valve, and close the hose's drip-proof valve.

2. Verify the hose is secured and open the drip-proof valve on the end of the hose.
3. Open the waste water holding tank valve. Press and hold the rocker switch (labeled Black Valve) in the UP position until the switch illuminates (2-3 seconds), indicating the valve is open.
4. Turn on the macerator pump (waste pump). Watch all connections while dumping. As soon as the waste water tank is empty, turn off the pump.
5. Close the waste tank valve (press and hold the rocker switch DOWN until the light extinguishes).

NOTE

Only one valve at a time can be open.

6. Flush the waste tank; [see Waste Tank Flush on page 9-8.](#)
7. Open the gray tank valve.
8. Turn on the macerator pump. Run the pump until just before it runs dry. Any trickle of gray water left will remain in the discharge hose behind the drip-proof valve.
9. Close the gray tank valve.
10. Close the hose's drip-proof valve and remove the hose from the disposal facility inlet. Grasp the hose to prevent slack, and then press and hold the retract switch to reel it in. Guide the hose side-to-side so it spools onto the reel evenly.

NOTE

Always empty the waste water tank before emptying the gray water tank. The gray water will help flush the pump and hose of wastewater.

Macerator Impeller Release Feature

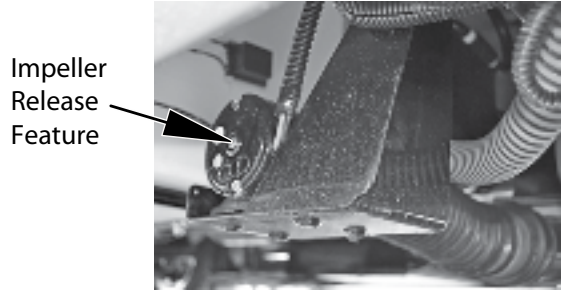

After long periods of non-use, a stuck impeller can be easily broken loose with a screwdriver inserted in the motor shaft slot. Remove the rubber boot, turn the shaft clockwise, and replace the rubber boot. The impeller can usually be found under the touring coach, near the macerator hose reel.

Manual Operation

In case the electric dump valves fail to open, manually pull/push the arm once, to open and close the valve. The manual arm is located under the vehicle, near the macerator hose reel.

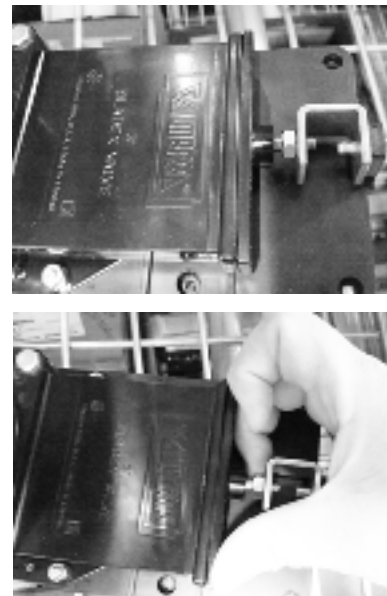

Extended Stays

When you are in a park with a disposal facility, empty the tanks every few days or whenever they become almost full. Pumping a large volume of liquid through the tanks at a time will keep toilet paper and other solids completely washed away. Remember to empty the waste water tank first and then the gray water tank using the gray water to flush the system. This practice will help avoid the accumulation of solids in the tank, which could lead to an unpleasant cleaning job.

Maintenance

Should solids accumulate, fill the tank about half full with water using the waste tank flush inlet and then drive the touring coach for a few miles. Don't wait until the tank is packed solid. The turbulence and surging of the water will usually dissolve the solids into a suspension so the tank can be drained. Draining the tanks as described will protect them from freezing during storage.

Waste Tank Flush



Airstream advises flushing the waste water holding tank each time it is emptied to prevent clogging of the water jets and accumulation of waste solids inside the tank. Start by emptying the holding tanks at an approved dump station, close the waste tank valve, and leave the macerator hose connected to the drain. To flush the tank:

1. Attach a water hose to the flush inlet inside the hose compartment (do not use the fresh water tank hose). Turn the water on and monitor the waste tank level. Fill the tank about half full and turn the water off.
2. Empty the waste holding tank; [see Emptying the Holding Tanks on page 9-7](#).
3. Close the waste holding tank valve and repeat this process until the water runs clear.
4. Close the hose's drip-proof valve and remove the hose from the disposal facility inlet. Grasp the hose to prevent slack, and then press and hold the retract switch to reel it in. Guide the hose side-to-side so it spools onto the reel evenly.

Drain System Cleaning

The only cleaning agents that can be used without causing harm to the system are household ammonia and tri-sodium phosphate in small quantities. Do not use any product that contains any portion of petroleum distillates. This type of product will attack the rubber seals of your toilet and dump valve. Also, do not use any dish detergent or abrasive cleaners. All products should be marked as approved for ABS drain systems.

Winterizing and Storage

When storing your touring coach, use the same precautions as you would in your own home in regard to perishables, ventilation, winterizing, and rain protection. In addition, for prolonged storage periods, flush out all the drain lines and waste holding tanks. Also, drain the entire water system, including the water heater and the fresh water tank. Instructions for draining the water system are explained in the following paragraphs on winterizing.

The main consideration in winterizing is to guard against freezing damage to the fresh water lines, the waste drain lines, the waste holding tanks, the water heater, and the batteries.

NOTICE

Sprinter recommends disconnecting the current to all chassis electric consumers using the engine battery disconnect cable if the vehicle sits for periods longer than 30 days. This will save jump starts, battery charge ups, and possible battery damage and replacement. The Mercedes-Benz Sprinter Operator's Manual describes its location, operation, and cautions in detail.

NOTICE

In very cold weather, winterizing the motor coach is recommended to prevent damage to the waste systems.

Component Locations for Winterization

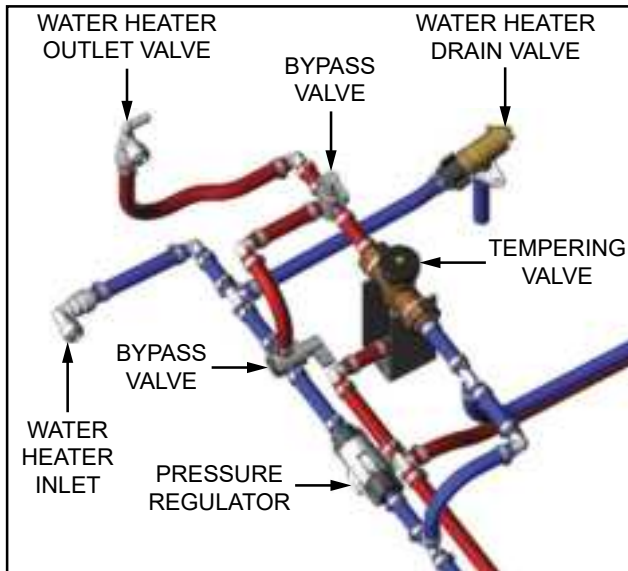

The above components can be accessed by removing the roadside bench seat cushion and forward access panel. Valves are shown in the Normal Use position. Component locations may vary slightly from depiction.

Low Point Drain Valves: roadside exterior, under the vehicle, behind the bumper.

Fresh water tank drain plug: on the bottom of the fresh water tank under the touring coach.

Water Pump and Winterization Valve: roadside interior, behind the lower front panel of the galley sink; to remove the panel, pull outward at the edge to release it from the catch grabbers holding it in place.

Winterization Procedure

To perform these steps, you will need an adapter with an air regulator to connect an air compressor to the city water inlet, and access to an air compressor. Adapters are available at most RV stores.

For the location of components mentioned throughout this procedure, see [Component Locations for Winterization on page 9-9](#).

Instructions for Winterization

1. Level the touring coach from side to side and from front to rear.
2. Turn the water pump OFF and disconnect the city water.
3. OPEN all the water faucets and shower heads, hot and cold, internal and external.
4. OPEN the low-point drain valves and water heater drain valve. REMOVE the fresh water tank plug. Allow the system time to drain completely.

5. Turn both of the water heater bypass valves from the normal use position a quarter-turn to the bypass position.

NOTICE

The furnace/water heater manufacturer does not recommend blowing air through the water heater or adding antifreeze to the water heater. Air pressure and antifreeze will cause damage to internal components. Refer to the manufacturer's user manual for additional winterization instructions.

6. For this step, you will need someone to operate the toilet foot pedal/flush valve. Using the air compressor, apply at MAX 50 lbs. of air pressure at the city water inlet until no water remains in the system. Operate the foot pedal on the toilet. You may need to depress the pedal a few times to work out all the water by allowing some air pressure to build up between flushing. Once all the water has been blown from the system, disconnect the air and continue to the next step.
7. For this step, have a catch pan or a towel ready to place under the water pump outlet to prevent water from running out into the touring coach. Remove the quick-connect outlet fitting from the water pump. Turn the pump ON briefly to remove any remaining water from the pump head and lines running from the tank.

⚠ WARNING

The water pump is mounted near wiring and electrical components. Exercise caution to avoid electric shock or inadvertently disconnecting touring coach wiring when accessing the pump. Turn off all power using the battery disconnect and ensure all circuits in the vicinity of the pump are de-energized before accessing the pump.

8. Check the water pump strainer to be sure no water remains.
9. Leave drains open and fittings from the pump disconnected until the system is ready to be used again. Best practice: leave a note as a reminder near the multiplex panel to close drain valves, return the bypass valves to normal use position, reconnect the water pump, and reinstall the fresh tank drain plug.

NOTICE

Do not overtighten the fresh water tank drain plug. Overtightening may strip the threads on the tank, plug, or both.

10. If you plan to add RV antifreeze using the optional procedure below, save this step for the end. Otherwise, Fully charge the house battery pack and turn off the battery disconnect switch.

Optional-Additional Steps for Winterization

An additional step to winterization is to consider adding a non-toxic RV antifreeze (approved for drinking water systems) to the water lines using the pre-installed Winterization Kit.

Before beginning, read the RV antifreeze manufacturer's label for instructions specific to the antifreeze you plan to use. It may take a few gallons to fill the entire system so prepare accordingly. As you follow these steps, it will be helpful to have another person watching and operating the faucets, shower heads and toilet valve.

1. RECONNECT all lines, CLOSE all drain valves, and REINSTALL the fresh water tank plug.

NOTICE

Do not overtighten the fresh water tank drain plug. Overtightening may strip the threads on the tank, plug, or both.

2. OPEN the sink and shower drains if they are closed.
3. Ensure all the water faucets and shower heads, hot and cold, internal and external, are OPEN.
4. Ensure the water heater bypass valves are in the BYPASS position as mentioned in the previous steps for winterization.



5. SET the winterize valve selector to "winterize" by rotating it clockwise (normal flow position shown above) [see Component Locations for Winterization on page 9-9](#).
6. Uncoil the hose attached to the kit, remove the hose cap, and insert the hose down to the bottom of the RV antifreeze container.
7. Turn the water pump ON and run it until antifreeze starts coming out of the faucets. Once antifreeze is running from the taps you can start closing them. Move from one fixture to the next, shutting them off as you go until all the lines are full. Turn the pump OFF as you empty and transition from one antifreeze container to the next.
8. Allow the antifreeze to flow down drains. Flush the toilet and allow antifreeze to flow down the toilet. If equipped, operate the toilet hand sprayer until antifreeze is coming out. If equipped, work the hand shower sprayer while holding it down in the shower until antifreeze is coming out, and do the same with the external shower head. Dump any remaining small amounts of antifreeze down a drain.
9. Shut the water pump OFF once all the lines are full.
10. OPEN all the faucets and leave them open.
11. Turn the winterization valve back to the normal flow position, place the cap back on the hose, and coil it back up for storage.

NOTICE

Remove all RV antifreeze spillage from all sinks, drain pans, and faucet parts after winterizing. Failure to do so could damage surface finishes. Do not use water to rinse antifreeze down the drain as it will dilute the antifreeze.

12. Fully charge the house battery pack and turn off the battery disconnect switch.

Water Heater Maintenance and Winterizing

⚠ WARNING

Never actuate the drain lever if the water heater is under pressure and/or still hot. Use caution when operating the drainage valve to avoid potential scalding injury from hot water.

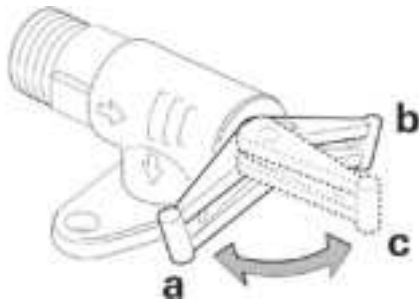

The furnace/water heater requires periodic service (e.g. decalcification). Please refer to the manufacturer’s manual for required maintenance intervals.

The furnace/water heater has a relief valve/drain located near the water heater; see [Component Locations for Winterization on page 9-9](#). To drain the water heater, move the lever on the end of the valve to position (c) as depicted above. Water will drain via the drainage socket. To close the valve for normal operation, move the lever to (a or b). For more information, see [Water Heater Pressure Relief/Drain Valve on page 5-25](#).

NOTICE

When traveling to a location where freezing conditions are likely, or when storing the trailer, be sure to drain all water from the water system and water heater.

NOTICE

If warranty service is required, use only a service location recommended by the furnace manufacturer or your Airstream dealer.

NOTICE

The furnace/water heater manufacturer does not recommend blowing air through the water heater or adding antifreeze to the water heater. Air pressure and antifreeze will cause damage to internal components. Refer to the manufacturer’s user manual for winterization instructions.

Macerator Pump Winterizing

Plan your winterizing and storage ahead, and be sure the holding tanks are drained and flushed thoroughly. This is very important, as the frozen sewage and water could seriously damage the system. After dumping the tanks, add RV, non-toxic antifreeze to one of the holding tanks and start the macerator pump. Run the pump until the RV, non-toxic antifreeze comes out the end of the pump hose, then close the dump valve. As extra protection, open the toilet valve and add RV, non-toxic antifreeze through the toilet into the waste water tank and pour RV, non-toxic antifreeze into a sink drain to protect the holding tanks, valves, and pump from residual water freezing.

Vehicle Storage

In addition to winterizing your coach, the following practices are recommended to prevent damage that can occur during storage:

- Because brake fluid absorbs moisture from the air, Mercedes-Benz recommends changing the brake fluid when the vehicle is not driven for long periods or when stored for over six months.
- Do NOT use any fuel additives for storage.
- Fill the fuel tank to FULL before storage and use diesel fuel with a bio-diesel content of 5% (B5) or less to avoid moisture buildup and contamination. Storing the vehicle with B20 fuel is not recommended as it may promote algae growth. Do not store the vehicle for more than 30 days with B20 diesel fuel in the tank.
- While it is not required, you may opt to change the oil before storage to flush out any contaminants.
- Move the vehicle regularly or use tire-saver ramps to help prevent flat spotting. Tires can be inflated to 80 PSI to help prevent flat spotting, but they must be inflated to the correct pressure before driving. Keep a note on the vehicle or with the keys as a reminder to adjust the tire pressure prior to driving. If tire-saver ramps are not used, move the vehicle a few feet periodically to avoid flat spotting.
- Clean the interior of the vehicle and remove all food and beverage items. Empty, clean, and turn off the refrigerator and leave the door open to avoid mold growth. If mice or other rodents enter the vehicle, they can chew through wiring and cause significant damage. Consider using a rodent repeller.

Maintenance

Restoring Service

1. Close all drain valves, holding tank dump valves, water faucets, and fresh water tank drain.

NOTICE

Do not overtighten the fresh water tank drain plug. Overtightening may strip the threads on the tank, plug, or both.

2. Reconnect water pump line.
3. Add water to the fresh water tank.
4. Turn the water pump on.
5. Open and close faucet valves one at a time until water runs clear at all faucets signaling RV, non-toxic antifreeze is flushed out of lines. Go back and recheck water clarity at all faucets.
6. Turn off water pump.
7. Hook up city water, open faucet valves, and recheck water clarity.
8. Close water heater drain valve and reset the water heater bypass valves to normal operating positions.

Toilet

Toilet Winterizing

Draining Method: Turn off touring coach's water supply. Drain toilet bowl. Disconnect supply line at water valve. Completely drain the toilet's water supply line.

Antifreeze Method: Use RV, non-toxic antifreeze only.

NOTICE

To avoid damage when using air pressure to blow water from the lines, make sure the toilet valve is in the open position.

NOTICE

If water is frozen in the toilet, do not attempt to flush until the ice thaws. Never use automotive type antifreeze.

Maintenance

If the bowl-sealing blade does not operate freely after extended use, it may be restored to its original, smooth operating condition by applying a light film of silicone spray to the blade. To clean the toilet use Thetford Aqua Bowl or any other high grade, non-abrasive cleaner. Do not use highly concentrated or high acid content household cleaners. They may damage the rubber seals.

Troubleshooting

1. Leaks:
 - a. Back of toilet: check water supply line connection at water valve. Secure or tighten as necessary. If leak persists from water valve, replace.
 - b. Vacuum breaker leaks while flushing: replace vacuum breaker or water module, depending on model.
 - c. Between closet flange and toilet: check flange nuts for tightness. If leak continues, remove toilet and check flange height. Use Thetford spacers to adjust, if necessary, to 7/16-in. above floor. Replace flange seal.
2. Toilet won't hold water:
 - a. Check for and remove any debris from blade-ball seal track.
 - b. Check blade/ball seal compression mechanism. If blade/ball seal is worn, replace.
3. Harder than normal pedal operation: Apply light film of Thetford Toilet Seal Lubricant & Conditioner or silicone spray to blade/ball. (Note: To avoid damage, do not use spray lubricants other than silicone.)
4. Poor flush: The pedal must be held completely down to flush. A good flush should be obtained within 2 to 3 seconds. If problem persists, remove the water supply line and check flow rate.

12-Volt Schematic

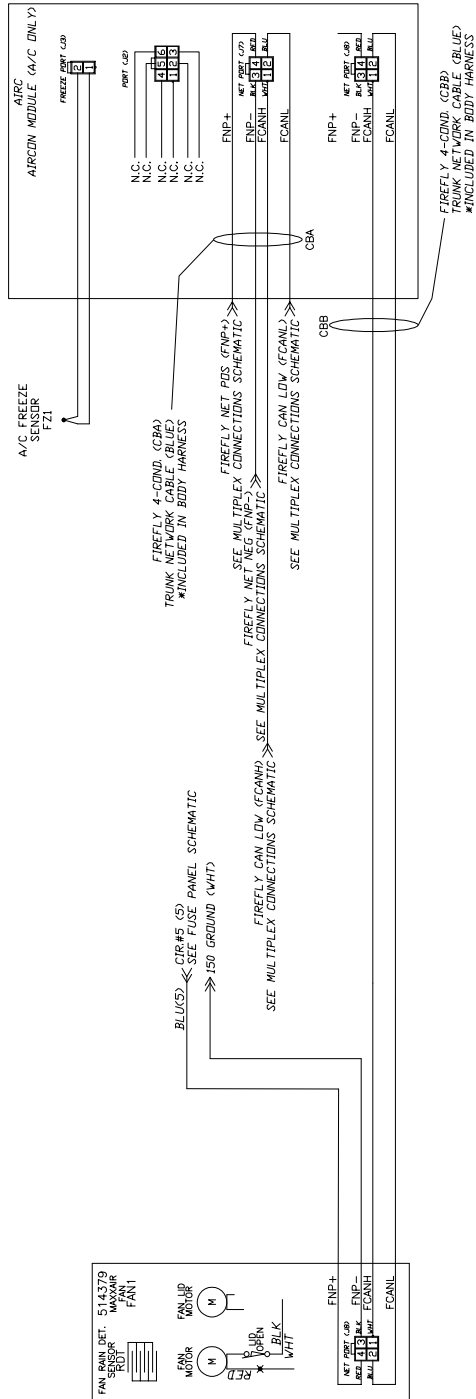

This document and the information contained within are confidential and proprietary to Airstream, Inc. and shall not be copied, distributed or used in whole or in part without express written consent.

* SCHEMATIC ONLY SHOWS GENERAL WIRE CONNECTIONS NOT ACTUAL WIRE ROUTING. SEE HARNESS DRAWINGS FOR ROUTING.

Audio and Video Schematic

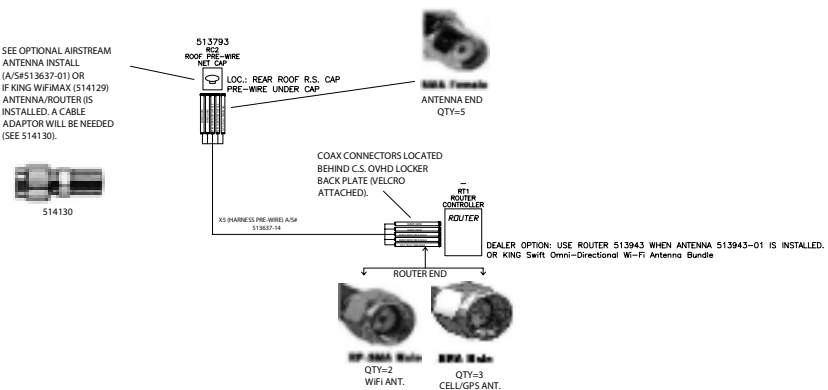
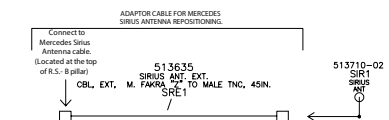
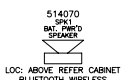
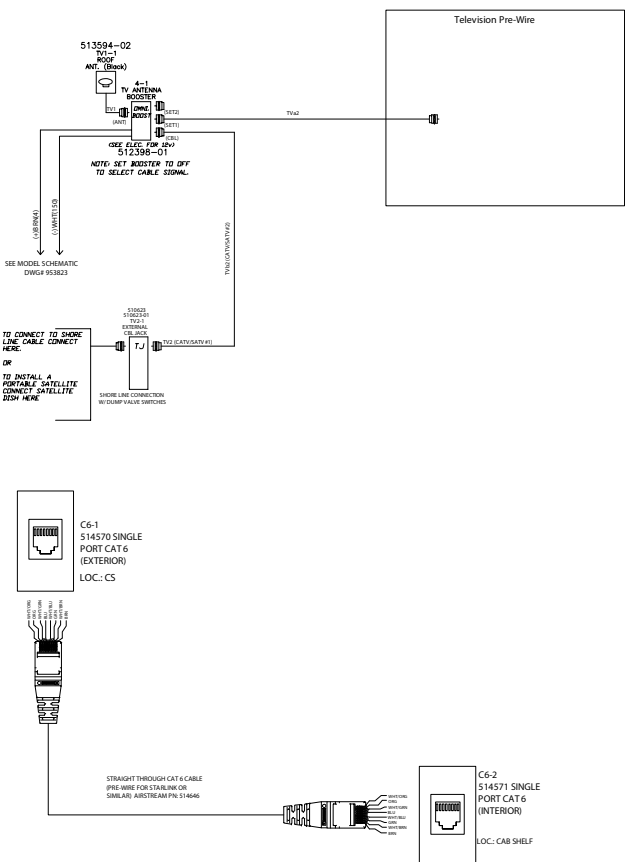

This document and the information contained within are confidential and proprietary to Airstream, Inc. and shall not be copied, distributed or used in whole or in part without express written consent.

Fresh Water Layout

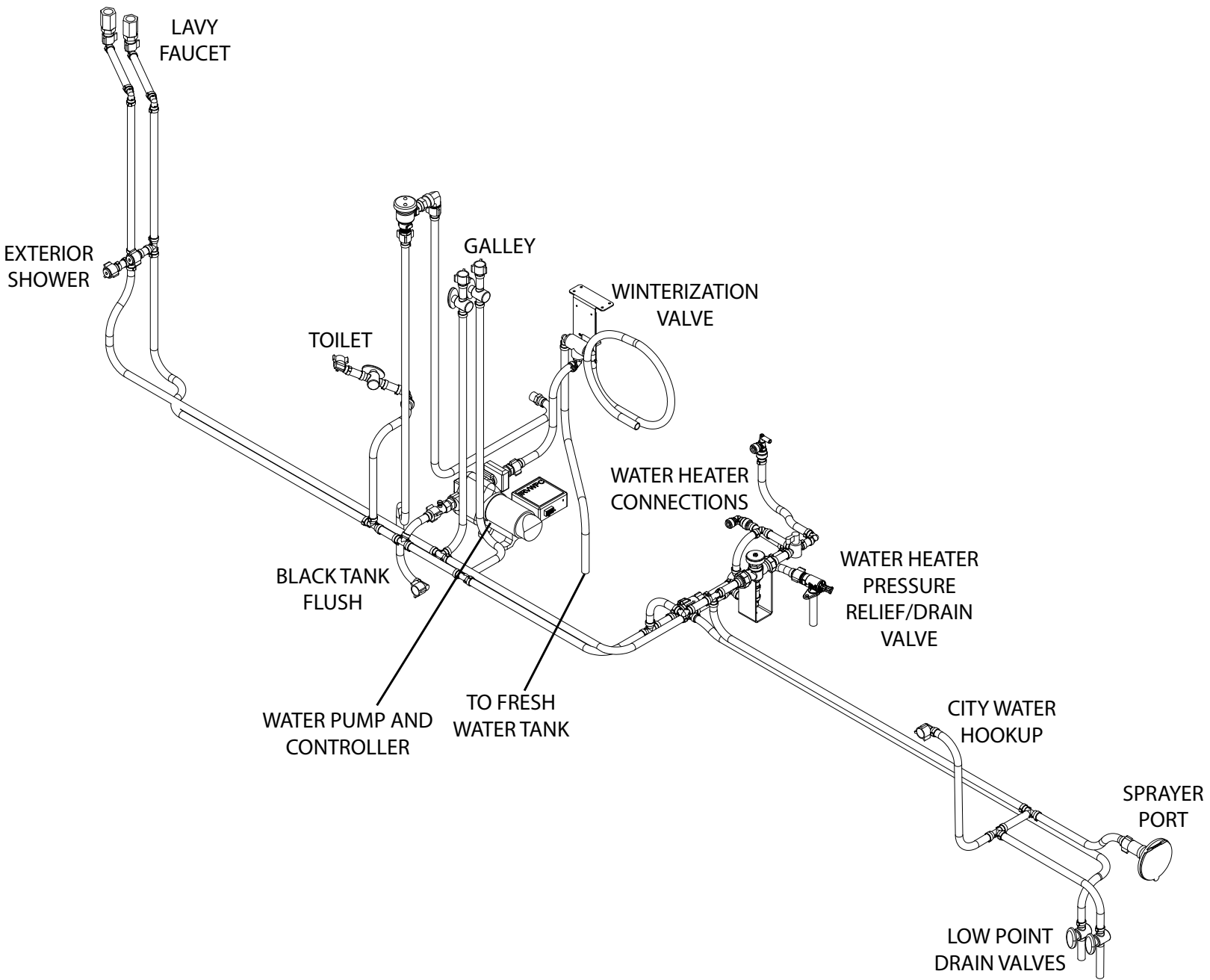

FAQs and Answers

Electrical

1. *What kind of battery do I have in my Airstream?*

Answer: The Advanced Power system includes three 270Ah Battle Born Gamechanger LiFePO4 (Lithium Iron Phosphate) batteries, built into a battery pack that provides 810Ah of total capacity; [see House Battery Pack on page 5-14](#)

2. *My house battery is dead and I am no where near a shoreline power source, what can I do?*

Answer: The engine is equipped with a powerful secondary alternator that will charge the house battery pack simply by driving. In fact, it is the fastest way to charge your house battery; [see Charging via Secondary Alternator on page 5-17](#)

3. *What sort of temperature limits can my house battery be subjected to?*

Answer: There are several things to consider with regard to operating temperatures, and temperatures at which you can charge the battery; [see Temperature Limits on page 5-15](#).

4. *What is the battery disconnect switch's function?*

Answer: The battery disconnect switch isolates the house batteries from the 12-volt distribution panel and charging system; [see Battery Disconnect Switches on page 5-11](#).

5. *Do you recommend using a surge protector when plugged into shore power?*

Answer: Your Airstream is breaker protected. However, with the use of more personal electronic devices and the number of motorhome users in parks, added protection is always a plus. If you are having trouble charging your house battery, remove the surge protector.

6. *What is my inverter powering?*

Answer: It is powering all appliances (air conditioning, microwave, etc.) and all outlets/receptacles. Your inverter is actually an inverter/charger, and it performs multiple functions; [see Inverter/Charger on page 5-13](#).

7. *I have an alarm going off at my sliding door.*

Answer: Make sure your awning is completely closed. If not properly closed, and the engine is running, it will cause the alarm to sound.

Plumbing

1. *Do I need a water regulator?*

Answer: No, your Airstream is equipped with a built in regulator rated for 50 psi.

2. *How do I get fresh water into my Coach?*

Answer: You can use the on board fresh water tank and 12-volt pump for your water supply when camping in a remote area, or hook to an external water source via potable water hose to the exterior city water inlet when parked at a campground; [see City Water Hookup on page 6-6](#).

3. *What is the difference between a gray water tank and the waste water tank?*

Answer: The gray water tank holds water from shower and sink drains. The waste water tank holds sewer water from the toilet.

4. *Can I run the macerator pump if there is no water going through it?*

Answer: No, it will burn the macerator up if it is run dry for more the 10-30 seconds. Also, you should not run it more than 15 minutes continuously.

5. *How do I use the waste tank flush?*

Answer: For instructions on how to use the tank flush, [see Waste Tank Flush on page 9-8](#)

6. *The gray water valve will not open while I have the waste water valve open.*

Answer: Only one valve can be open at a time.

Audio-Video

1. *My TV reception is poor. What can I check?*

Answer: If you have installed an aftermarket TV using the TV pre-wire, verify if your antenna booster is set to proper selection (ON for antenna and OFF for cable satellite). You should also make sure connections are tight on your TV; [see TV Pre-wire and TV/Radio Antenna on page 5-20](#).

2. *If I install a TV and Blu-Ray player, will they operate while traveling down the highway?*

Answer: Yes. Press the Battery Power On/Off pushbutton to turn on the system and turn on the inverter; [see Inverter/Charger on page 5-13](#).

3. *Does the TV play through the dash stereo?*

Answer: No, the TV's audio is not connected to the dash radio.

Chassis

1. *Where is my spare tire located?*

Answer: A spare tire is not supplied with the touring coach.

2. *How do I jack the touring coach up to change a tire?*

Answer: Please refer to the Mercedes owner's manual.

3. *Where can I find my serial number?*

Answer: A label is attached on the driver's side B-pillar or the passenger's door. This label will also provide the inflation pressure of the tires and weight specifications.

Appliances

1. *I am planning for a trip in my Airstream. How should I get the refrigerator cooled down?*

Answer: Turn the power on and set the thermostat between 3 and 4. You can make further adjustments to suit your personal requirements after the box has cooled down. Allow the refrigerator to come down to temperature before loading with product. Setting the thermostat to a higher setting, e.g. 7, will not decrease the time required for the unit to cool down to its normal operating temperature. AC/DC units cool at the same rate on DC as on AC. Normal refrigerator operating temperatures are 34°F to 40°F.

2. *If I'm driving to my destination, will my refrigerator stay on?*

Answer: If you press the Battery Power On/Off pushbutton, yes.

3. *My air conditioner freezes up. What is the problem?*

Answer: In high humidity conditions, the AC manufacturer recommends you operate your AC (manual mode) on the high fan setting and all vents should be open to have maximum air flow over the coils; this helps reduce icing. Also, dirty AC filters can restrict air flow and cause the AC to ice up.

Maintenance

1. *Can I have my awning out with heavy winds?*

Answer: No this may cause damage if it is too windy. However, the awning does have a built in sensor that will automatically retract the awning.

2. *I want to clean the exterior of my Airstream. What do you suggest?*

Answer: Airstream recommends washing the exterior using a mild, auto detergent, safe for clear coated surfaces. Airstream recommends washing based on operating conditions, and waxing a minimum of twice a year. Any automotive wax designed specifically for clear coated surfaces will provides good wax protection; [see Exterior Care on page 6-2](#)

Index

A

- Air Conditioner 5-21
- Airstream Academy ii
- Alarms and Detectors 2-3
- Alternator 5-17
- Antennas 5-20
- Appliances 5-21
 - Cooktop 5-21
- Awning 6-9

B

- Backup Converter 5-13
- Battery Disconnect Switch 5-11
- Battery Heaters 5-15
- Battery Life 5-16
- Battery Management System (BMS) 5-14
- Battery Monitoring/State of Charge (SOC) 5-16
- Battery Pack 5-14
- Bluetooth App 5-19
- Bluetooth Speaker 5-20
- Body Kit 6-3
- Brake Controller 8-7
- Breaker Test 5-9
- Brushguard 6-7

C

- Camping 3-6
 - Effects of Prolonged Occupancy 3-8
 - Overnight Stop 3-7
- Carbon Monoxide 2-5
- Carbon Monoxide Detector 2-3
- Carefree Connects 6-9
- Cargo Storage 5-6
- Charger 5-13
- Chemical Sensitivity 2-2
- Circuit breakers 5-8
 - GFCI 5-9
- City Power 5-10
- City Water Hookup 6-6
- Cleaning
 - Interior 5-3
- Clothesline 5-5
- Coach-Net 3-5
- Countertops 5-4

D

- DC-DC Charger 5-17
- Detectors 2-3
- Diesel Exhaust 2-7
- Diesel Operated Systems 2-2
- Door 6-11
 - Screen Door 6-11
- Doormat and Rug Selection 5-4
- Doors
 - Rear Screen 6-11
- Drain and Waste System 9-6
- Drain System 3-10
- Drain Valves 9-9

E

- Electrical Diagrams 9-13
- Electrical System Operation 5-11
- Electrical System Overview 5-8
- Emergency Exit 2-8
- EMS 5-12
- Energy Management System 5-12
- Entertainment Systems 5-20
- Exterior Care 6-2
- Exterior Features 6-6

F

- Fan 5-22
- FAQs and Answers 9-23
- Faucet Care 5-5
- Fire Extinguisher 2-7
- Firefly 5-18
- Floor 5-4
- Floor Plans 4-2
- Formaldehyde 2-2
- Fox Performance Elite Series shocks 6-7
- Fresh Water Layout 9-22
- Fuels and Operating Fluids 7-2
- Fuse Locations 5-9

G

- GFCI 5-9
- Gross Axle Weight Rating (GAWR) 4-4
- Gross Combined Vehicle Weight Rating (GCWR) 4-4
- Gross Vehicular Weight Rating (GVWR) 4-4

H

- Heating 5-23
- Hitch 8-4

I

- Inverter 5-13
- Inverter/Charger 5-13

J

- Jump-Start, RedArc 5-17

K

- KC Lights 6-7

L

- Labels 4-4
- Leveling 3-7
- Lighting 5-19, 6-7
- Loading 8-2
- L-Track 5-6
- Lug Nut Tightening 7-8

M

- Macerator Pump 9-6
 - Winterizing 9-11
- Maintenance Schedule 9-2
- Manufacturer's Certification Label 4-4
- Mercedes me Connect App 7-2
- Microwave 5-25
- Microwave Ovens 5-25
- Mira 5-19
- Mold 2-2, 3-9
- Multiplex System
 - Bluetooth App 5-19

O

- Occupant and Cargo Carrying Capacity Label 4-4
- Off Road Lights 6-7
- Outlets 5-10

P

- Parts 9-3
- Plumbing 9-4
 - Component Locations for Winterization 9-9
- Power Center 5-8
- Power Loss 5-13

Index

R

REDARC Alpha 5-17
Refrigerator/Freezer 5-25
Roadside Assistance 3-5
Rug Selection 5-4

S

Safety 2-8, 8-4
Sanitizing 9-5
Satellite 5-20
Screen Door 6-11
Seat belts 8-4
Service 3-5, 9-3
Shades 5-4
Shocks, Adjustable 6-7
Shoreline Connection 5-16
Shoreline Power Inlet and Cordset
6-8
Shower, Exterior 6-6
Shower, Interior 5-5
Sink and Faucet Care 5-5
Smoke Alarm 2-3
Maintenance of Smoke/CO De-
tector 2-6
Solar Ports 6-9
Solar System 5-11, 5-17
Speaker 5-20
Specifications 4-3
Specification Tags 4-4
State of Charge (SOC) 5-16
Storage 5-6
Strainer 9-4

T

Table 5-8
Tank Heaters 3-11
Temperature Limits 5-15
Tempering Valve 5-25
Tire and Loading Placard 4-4
Tire Care
Inflation Pressure 4-3
Tire Size 4-3
Tires 7-4
Care 9-3
Changing 7-6
Inflation 7-4
Rotation 7-9
Toilet 5-5
Winterizing 9-12
Torque Value 4-3
Towing 8-4
Backing Up 8-8
Hitch 8-4
Towing a Boat 8-6
Trailer 8-6
Your Touring Coach 8-9
TV Pre-wire and TV/Radio Anten-
nas 5-20

U

Unloaded Vehicle Weight (UVW)
4-4
User Guide Videos ii

V

Vehicle Storage 9-11
Vent Fan 5-22
Ventilation 2-2, 2-3
Videos ii
Vinyl Floor 5-4

W

Waste Tank Flush 9-8
Wastewater System 3-9
Water Fill 6-6
Water Heater 5-23
Hot Water Tempering Valve 5-25
Water Heater Pressure Relief/
Drain Valve 5-25
Winterizing 9-11
Water Pump 9-5
Water Pump and Strainer 9-4
Water System 9-4
Weighing 8-2
Weight Distribution 8-3
Wheel Bolt/Lug Nut Tightening 7-8
Windows 6-6
Shades 5-4
Winterization Valve 9-9
Winterizing and Storage 9-8
Component Locations for Winter-
ization 9-9
Winter Traveling 3-10

AIRSTREAM®

1001 West Pike Street

P.O. Box 629

Jackson Center, OH. 45334-0629

Phone: (937) 596-6111 Fax: (937) 596-7939

www.airstream.com