

Installation Instructions

Original Instructions



Allen-Bradley

by ROCKWELL AUTOMATION

POINT I/O ControlNet Adapter

Catalog Numbers 1734-ACNR, 1734-ACNRK

Catalog numbers with the suffix 'K' are conformal coated and their specifications are the same as non-conformal coated catalogs.

Topic	Page
Summary of Changes	1
About the Adapter	5
Before You Begin	5
Install the ControlNet Adapter	6
Set the Node Address	6
Install a Replacement ControlNet Adapter to an Existing System	6
Wire the ControlNet Adapter	7
Interpret the Status Indicators	8
Specifications	9
Additional Resources	11

Summary of Changes

This publication contains the following new or updated information. This list includes substantive updates only and is not intended to reflect all changes.

Topic	Page
Updated General Specifications	9
Updated Certifications	11
Updated Additional Resources	11



ATTENTION: Read this document and the documents listed in the Additional Resources section about installation, configuration and operation of this equipment before you install, configure, operate or maintain this product. Users are required to familiarize themselves with installation and wiring instructions in addition to requirements of all applicable codes, laws, and standards.

Activities including installation, adjustments, putting into service, use, assembly, disassembly, and maintenance are required to be carried out by suitably trained personnel in accordance with applicable code of practice. If this equipment is used in a manner not specified by the manufacturer, the protection provided by the equipment may be impaired.

注意: 在安装、配置、操作和维护本产品前，请阅读本文档以及“其他资源”部分列出的有关设备安装、配置和操作的相应文档。除了所有适用规范、法律和标准的相关要求之外，用户还必须熟悉安装和接线说明。

安装、调整、投运、使用、组装、拆卸和维护等各项操作必须由经过适当训练的专业人员按照适用的操作规范实施。

如果未按照制造商指定的方式使用该设备，则可能会损害设备提供的保护。

ATENCIÓN: Antes de instalar, configurar, poner en funcionamiento o realizar el mantenimiento de este producto, lea este documento y los documentos listados en la sección Recursos adicionales acerca de la instalación, configuración y operación de este equipo. Los usuarios deben familiarizarse con las instrucciones de instalación y cableado y con los requisitos de todos los códigos, leyes y estándares vigentes.

El personal debidamente capacitado debe realizar las actividades relacionadas a la instalación, ajustes, puesta en servicio, uso, ensamblaje, desensamblaje y mantenimiento de conformidad con el código de práctica aplicable. Si este equipo se usa de una manera no especificada por el fabricante, la protección provista por el equipo puede resultar afectada.

ATENÇÃO: Leia este e os demais documentos sobre instalação, configuração e operação do equipamento que estão na seção Recursos adicionais antes de instalar, configurar, operar ou manter este produto. Os usuários devem se familiarizar com as instruções de instalação e fiação além das especificações para todos os códigos, leis e normas aplicáveis.

É necessário que as atividades, incluindo instalação, ajustes, colocação em serviço, utilização, montagem, desmontagem e manutenção sejam realizadas por pessoal qualificado e especializado, de acordo com o código de prática aplicável.

Caso este equipamento seja utilizado de maneira não estabelecida pelo fabricante, a proteção fornecida pelo equipamento pode ficar prejudicada.

ВНИМАНИЕ: Перед тем как устанавливать, настраивать, эксплуатировать или обслуживать данное оборудование, прочитайте этот документ и документы, перечисленные в разделе «Дополнительные ресурсы». В этих документах изложены сведения об установке, настройке и эксплуатации данного оборудования. Пользователи обязаны ознакомиться с инструкциями по установке и прокладке соединений, а также с требованиями всех применимых норм, законов и стандартов.

Все действия, включая установку, наладку, ввод в эксплуатацию, использование, сборку, разборку и техническое обслуживание, должны выполняться обученным персоналом в соответствии с применимыми нормами и правилами.

Если оборудование используется не предусмотренным производителем образом, защита оборудования может быть нарушена.

注意: 本製品を設置、構成、稼働または保守する前に、本書および本機器の設置、設定、操作についての参考資料の該当箇所に記載されている文書に目を通してください。ユーザは、すべての該当する条例、法律、規格の要件に加えて、設置および配線の手順に習熟している必要があります。

設置調整、運転の開始、使用、組立て、解体、保守を含む諸作業は、該当する実施規則に従って訓練を受けた適切な作業員が実行する必要があります。

本機器が製造メーカーにより指定されていない方法で使用されている場合、機器により提供されている保護が損なわれる恐れがあります。

ACHTUNG: Lesen Sie dieses Dokument und die im Abschnitt „Weitere Informationen“ aufgeführten Dokumente, die Informationen zu Installation, Konfiguration und Bedienung dieses Produkts enthalten, bevor Sie dieses Produkt installieren, konfigurieren, bedienen oder warten. Anwender müssen sich neben den Bestimmungen aller anwendbaren Vorschriften, Gesetze und Normen zusätzlich mit den Installations- und Verdrahtungsanweisungen vertraut machen.

Arbeiten im Rahmen der Installation, Anpassung, Inbetriebnahme, Verwendung, Montage, Demontage oder Instandhaltung dürfen nur durch ausreichend geschulte Mitarbeiter und in Übereinstimmung mit den anwendbaren Ausführungsvorschriften vorgenommen werden.

Wenn das Gerät in einer Weise verwendet wird, die vom Hersteller nicht vorgesehen ist, kann die Schutzfunktion beeinträchtigt sein.

ATTENTION: Lisez ce document et les documents listés dans la section Ressources complémentaires relatifs à l'installation, la configuration et le fonctionnement de cet équipement avant d'installer, configurer, utiliser ou entretenir ce produit. Les utilisateurs doivent se familiariser avec les instructions d'installation et de câblage en plus des exigences relatives aux codes, lois et normes en vigueur. Les activités relatives à l'installation, le réglage, la mise en service, l'utilisation, l'assemblage, le démontage et l'entretien doivent être réalisées par des personnes formées selon le code de pratique en vigueur.

Si cet équipement est utilisé d'une façon qui n'a pas été définie par le fabricant, la protection fournie par l'équipement peut être compromise.

주의: 본 제품 설치, 설정, 작동 또는 유지 보수하기 전에 본 문서를 포함하여 설치, 설정 및 작동에 관한 참고 자료 섹션의 문서들을 반드시 읽고 숙지하십시오. 사용자는 모든 관련 규정, 법규 및 표준에서 요구하는 사항에 대해 반드시 설치 및 배선 지침을 숙지해야 합니다.

설치, 조정, 가동, 사용, 조립, 분해, 유지보수 등 모든 작업은 관련 규정에 따라 적절한 교육을 받은 사용자를 통해서만 수행해야 합니다.

본 장비를 제조사가 명시하지 않은 방법으로 사용하면 장비의 보호 기능이 손상될 수 있습니다.

ATTENZIONE: Prima di installare, configurare ed utilizzare il prodotto, o effettuare interventi di manutenzione su di esso, leggere il presente documento ed i documenti elencati nella sezione "Altre risorse", riguardanti l'installazione, la configurazione ed il funzionamento dell'apparecchiatura. Gli utenti devono leggere e comprendere le istruzioni di installazione e cablaggio, oltre ai requisiti previsti dalle leggi, codici e standard applicabili.

Le attività come installazione, regolazioni, utilizzo, assemblaggio, disassemblaggio e manutenzione devono essere svolte da personale adeguatamente addestrato, nel rispetto delle procedure previste. Qualora l'apparecchio venga utilizzato con modalità diverse da quanto previsto dal produttore, la sua funzione di protezione potrebbe venire compromessa.

DIKKAT: Bu ürünün kurulumu, yapilandirilmasi, isletilmesi veya bakimi öncesinde bu dokümanı ve bu ekipmanın kurulumu, yapilandirilmasi ve isletimi ile ilgili ilave Kaynaklar bölümünde yer listelenmiş dokümanları okuyun. Kullanıcılar yürürlükteki tüm yönetmelikler, yasalar ve standartların gereksinimlerine ek olarak kurulum ve kablolama talimatlarını da öğrenmek zorundadır.

Kurulum, ayarlama, hizmete alma, kullanma, parçaları birleştirme, parçaları sökme ve bakım gibi aktiviteler sadece uygun eğitimleri almış kişiler tarafından yürürlükteki uygulama yönetmeliklerine uygun şekilde yapılabilir.

Bu ekipman üretici tarafından belirlenmiş amacın dışında kullanılırsa, ekipman tarafından sağlanan koruma bozulabilir.

注意事項: 在安装、設定、操作或維護本產品前，請先閱讀此文件以及列於「其他資源」章節中有關安裝、設定與操作此設備的文件。使用者必須熟悉安裝和配線指示，並符合所有法規、法律和標準要求。

包括安裝、調整、交付使用、使用、組裝、拆卸和維護等動作都必須交由已經過適當訓練的人員進行，以符合適用的實作法規。

如果將設備用於非製造商指定的用途時，可能會造成設備所提供的保護功能受損。

POZOR: Než začnete instalovat, konfigurovat či provozovat tento výrobek nebo provádět jeho údržbu, přečtěte si tento dokument a dokumenty uvedené v části Dodatečné zdroje ohledně instalace, konfigurace a provozu tohoto zařízení. Uživatelé se musejí vedle požadavků všech relevantních vyhlásek, zákonů a norem nutně seznámit také s pokyny pro instalaci a elektrické zapojení.

Činnosti zahrnující instalaci, nastavení, uvedení do provozu, užívání, montáž, demontáž a údržbu musí vykonávat vhodně proškolený personál v souladu s příslušnými prováděcími předpisy.

Pokud se toto zařízení používá způsobem neodpovídajícím specifikaci výrobce, může být narušena ochrana, kterou toto zařízení poskytuje.

UWAGA: Przed instalacją, konfiguracją, użytkowaniem lub konserwacją tego produktu należy przeczytać niniejszy dokument oraz wszystkie dokumenty wymienione w sekcji Dodatkowe źródła omawiające instalację, konfigurację i procedury użytkowania tego urządzenia. Użytkownicy mają obowiązek zapoznać się z instrukcjami dotyczącymi instalacji oraz oprzewodowania, jak również z obowiązującymi kodeksami, prawem i normami.

Działania obejmujące instalację, regulację, przekazanie do użytkowania, użytkowanie, montaż, demontaż oraz konserwację muszą być wykonywane przez odpowiednio przeszkolony personel zgodnie z obowiązującym kodeksem postępowania.

Jeśli urządzenie jest użytkowane w sposób inny niż określony przez producenta, zabezpieczenie zapewniane przez urządzenie może zostać ograniczone.

OBSE! Läs detta dokument samt dokumentet, som står listat i avsnittet Övriga resurser, om installation, konfigurering och drift av denna utrustning innan du installerar, konfigurerar eller börjar använda eller utföra underhållsarbete på produkten. Användare måste bekanta sig med instruktioner för installation och kabeldragning, förutom krav enligt gällande koder, lagar och standarder.

Åtgärder som installation, justering, service, användning, montering, demontering och underhållsarbete måste utföras av personal med lämplig utbildning enligt lämpligt bruk.

Om denna utrustning används på ett sätt som inte anges av tillverkaren kan det hända att utrustningens skyddsanordningar försätts ur funktion.

LET OP: Lees dit document en de documenten die genoemd worden in de paragraaf Aanvullende informatie over de installatie, configuratie en bediening van deze apparatuur voordat u dit product installeert, configureert, bedient of onderhoudt. Gebruikers moeten zich vertrouwd maken met de installatie en de bedringsinstructies, naast de vereisten van alle toepasselijke regels, wetten en normen.

Activiteiten zoals het installeren, afstellen, in gebruik stellen, gebruiken, monteren, demonteren en het uitvoeren van onderhoud mogen uitsluitend worden uitgevoerd door hiervoor opgeleid personeel en in overeenstemming met de geldende praktijkregels.

Indien de apparatuur wordt gebruikt op een wijze die niet is gespecificeerd door de fabrikant, dan bestaat het gevaar dat de beveiliging van de apparatuur niet goed werkt.



ATTENTION: To comply with the CE Low Voltage Directive (LVD), this equipment must be powered from a source compliant with the Safety Extra Low Voltage (SELV) or Protected Extra Low Voltage (PELV).



WARNING:

- Secure any external connections that mate to this equipment by using screws, sliding latches, threaded connectors, or other means provided with this product.
- Do not disconnect equipment unless power has been removed or the area is known to be nonhazardous.

Prevent Electrostatic Discharge



ATTENTION: This equipment is sensitive to electrostatic discharge, which can cause internal damage and affect normal operation. Follow these guidelines when you handle this equipment:

- Touch a grounded object to discharge potential static.
- Wear an approved grounding wriststrap.
- Do not touch connectors or pins on component boards.
- Do not touch circuit components inside the equipment.
- Use a static-safe workstation, if available.
- Store the equipment in appropriate static-safe packaging when not in use.

Environment and Enclosure





ATTENTION: This equipment is intended for use in a Pollution Degree 2 industrial environment, in overvoltage Category II applications (as defined in EN/IEC 60664-1), at altitudes up to 2000 m (6562 ft) without derating. This equipment is not intended for use in residential environments and may not provide adequate protection to radio communication services in such environments.

This equipment is supplied as open-type equipment for indoor use. It must be mounted within an enclosure that is suitably designed for those specific environmental conditions that will be present and appropriately designed to help prevent personal injury resulting from accessibility to live parts. The enclosure must have suitable flame-retardant properties to help prevent or minimize the spread of flame, complying with a flame spread rating of 5VA or be approved for the application if nonmetallic. The interior of the enclosure must be accessible only by the use of a tool. Subsequent sections of this publication may contain more information regarding specific enclosure type ratings that are required to comply with certain product safety certifications.

In addition to this publication, see the following:

- Industrial Automation Wiring and Grounding Guidelines, publication [1770-4.1](#), for additional installation requirements.
- NEMA Standard 250 and EN/IEC 60529, as applicable, for explanations of the degrees of protection provided by enclosures.

North American Hazardous Location Approval

The Following Information Applies When Operating This Equipment In Hazardous Locations.	Informations sur l'utilisation de cet équipement en environnements dangereux.
<p>Products marked "CL I, DIV 2, GP A, B, C, D" are suitable for use in Class I Division 2 Groups A, B, C, D, Hazardous Locations and nonhazardous locations only. Each product is supplied with markings on the rating nameplate indicating the hazardous location temperature code. When combining products within a system, the most adverse temperature code (lowest "T" number) may be used to help determine the overall temperature code of the system. Combinations of equipment in your system are subject to investigation by the local Authority Having Jurisdiction at the time of installation.</p>	<p>Les produits marqués "CL I, DIV 2, GP A, B, C, D" ne conviennent qu'à une utilisation en environnements de Classe I Division 2 Groupes A, B, C, D dangereux et non dangereux. Chaque produit est livré avec des marquages sur sa plaque d'identification qui indiquent le code de température pour les environnements dangereux. Lorsque plusieurs produits sont combinés dans un système, le code de température le plus défavorable (code de température le plus faible) peut être utilisé pour déterminer le code de température global du système. Les combinaisons d'équipements dans le système sont sujettes à inspection par les autorités locales qualifiées au moment de l'installation.</p>
<div style="display: flex; align-items: center;">  <div> <p>WARNING: Explosion Hazard -</p> <ul style="list-style-type: none"> • Do not disconnect equipment unless power has been removed or the area is known to be nonhazardous. • Do not disconnect connections to this equipment unless power has been removed or the area is known to be nonhazardous. Secure any external connections that mate to this equipment by using screws, sliding latches, threaded connectors, or other means provided with this product. • Substitution of components may impair suitability for Class I Division 2. </div> </div>	<div style="display: flex; align-items: center;">  <div> <p>AVERTISSEMENT: Risque d'Explosion -</p> <ul style="list-style-type: none"> • Couper le courant ou s'assurer que l'environnement est classé non dangereux avant de débrancher l'équipement. • Couper le courant ou s'assurer que l'environnement est classé non dangereux avant de débrancher les connecteurs. Fixer tous les connecteurs externes reliés à cet équipement à l'aide de vis, loquets coulissants, connecteurs filetés ou autres moyens fournis avec ce produit. • La substitution de composants peut rendre cet équipement inadapté à une utilisation en environnement de Classe I Division 2. </div> </div>

UK and European Hazardous Location Approval

The following applies to products marked  II 3 G:

- Are intended for use in potentially explosive atmospheres as defined by UKEX regulation 2016 No. 1107 and European Union Directive 2014/34/EU and has been found to comply with the Essential Health and Safety Requirements relating to the design and construction of Category 3 equipment intended for use in Zone 2 potentially explosive atmospheres, given in Schedule 1 of UKEX and Annex II of this Directive.
 - Compliance with the Essential Health and Safety Requirements has been assured by compliance with EN IEC 60079-7, and EN IEC 60079-0.
 - Are Equipment Group II, Equipment Category 3, and comply with the Essential Health and Safety Requirements relating to the design and construction of such equipment given in Schedule 1 of UKEX and Annex II of EU Directive 2014/34/EU. See the UKEX and EU Declaration of Conformity at rok.auto/certifications for details.
 - The type of protection is Ex ec IIC T4 Gc according to EN IEC 60079-0:2018, EXPLOSIVE ATMOSPHERES - PART 0: EQUIPMENT - GENERAL REQUIREMENTS, Issue Date 07/2018, and CENELEC EN IEC 60079-7:2015+A1:2018, Explosive atmospheres. Equipment protection by increased safety "e".
 - Comply with Standard EN IEC 60079-0:2018, EXPLOSIVE ATMOSPHERES - PART 0: EQUIPMENT - GENERAL REQUIREMENTS, Issue Date 07/2018, CENELEC EN IEC 60079-7:2015+A1:2018 Explosive atmospheres. Equipment protection by increased safety "e", reference certificate number DEMKO 04 ATEX 0330347X and UL22UKEX2478X.
 - Are intended for use in areas in which explosive atmospheres caused by gases, vapors, mists, or air are unlikely to occur, or are likely to occur only infrequently and for short periods. Such locations correspond to Zone 2 classification according to UKEX regulation 2016 No. 1107 and ATEX directive 2014/34/EU.
 - May have catalog numbers followed by a "K" to indicate a conformal coating option.
-

IEC Hazardous Location Approval

The following applies to products marked with IECEx certification:

- Are intended for use in areas in which explosive atmospheres caused by gases, vapors, mists, or air are unlikely to occur, or are likely to occur only infrequently and for short periods. Such locations correspond to Zone 2 classification to IEC 60079-0.
 - The type of protection is Ex eC IIC T4 Gc according to IEC 60079-0 and IEC 60079-7.
 - Comply with Standards IEC 60079-0, Explosive atmospheres - Part 0: Equipment - General requirements, Edition 7, Revision Date 2017 and IEC 60079-7, 5.1 Edition revision date 2017, Explosive atmospheres - Part 7: Equipment protection by increased safety "e", reference IECEx certificate number IECEx UL 20.0072X.
 - May have catalog numbers followed by a "K" to indicate a conformal coating option.
-

WARNING: Special Conditions for Safe Use

- This equipment is not resistant to sunlight or other sources of UV radiation.
 - This equipment shall be mounted in an UKEX/ATEX/IECEx Zone 2 certified enclosure with a minimum ingress protection rating of at least IP54 (in accordance with EN/IEC 60079-0) and used in an environment of not more than Pollution Degree 2 (as defined in EN/IEC 60664-1) when applied in Zone 2 environments. The enclosure must be accessible only by the use of a tool.
 - This equipment shall be used within its specified ratings that are defined by Rockwell Automation.
 - Transient protection shall be provided that is set at a level not exceeding 140% of the peak rated voltage at the supply terminals to the equipment.
 - The instructions in the user manual shall be observed.
 - This equipment must be used only with UKEX/ATEX/IECEx certified Rockwell Automation backplanes.
 - Earthing is accomplished through mounting of modules on rail.
 - Devices shall be used in an environment of not more than Pollution Degree 2.
 - The secondary of a current transformer shall not be open-circuited when applied in Class I, Zone 2 environments.
-

ATTENTION:

- If this equipment is used in a manner not specified by the manufacturer, the protection provided by the equipment may be impaired.
 - Read this document and the documents listed in the Additional Resources section about installation, configuration, and operation of this equipment before you install, configure, operate, or maintain this product. Users are required to familiarize themselves with installation and wiring instructions in addition to requirements of all applicable codes, laws, and standards.
 - Installation, adjustments, putting into service, use, assembly, disassembly, and maintenance are required to be carried out by suitably trained personnel in accordance with applicable code of practice. In case of malfunction or damage, no attempts at repair should be made. The module should be returned to the manufacturer for repair. Do not dismantle the module.
 - This equipment is certified for use only within the surrounding air temperature range of -20...+55 °C (-4...+131 °F). The equipment must not be used outside of this range.
 - Use only a soft dry anti-static cloth to wipe down equipment. Do not use any cleaning agents.
-

About the Adapter

The POINT I/O™ ControlNet® adapter is a communications interface for POINT I/O modules. The adapter provides an interface for controlling and communicating with POINT I/O modules from a ControlNet network.

See [Figure 1](#) to identify the external features of the adapter.

Figure 1 - POINT I/O ControlNet Adapter

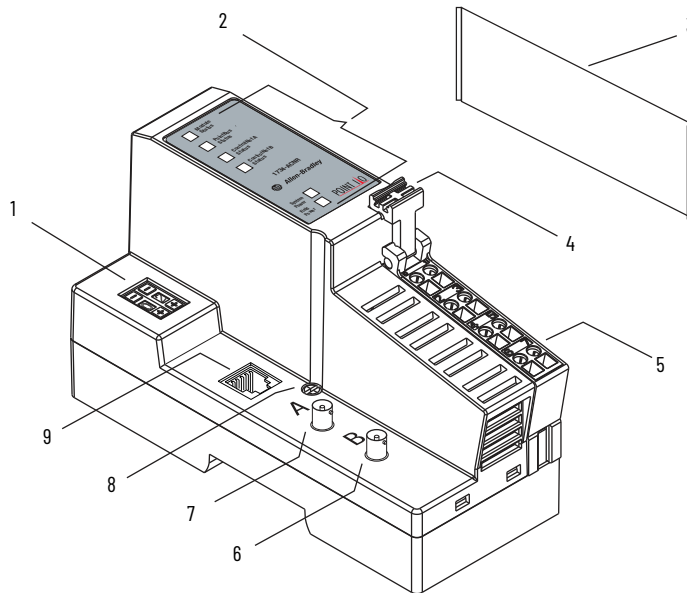

	Description		Description
1	Node address thumbwheel	6	Coaxial channel B
2	Status indicators	7	Coaxial channel A
3	Safety end cap	8	DIN rail locking screw (orange)
4	Removable Terminal Block (RTB) removable handle	9	Network Address Port (NAP)
5	RTB		



ATTENTION: This product is grounded through the DIN rail to chassis ground. Use zinc-plated chromate-passivated steel DIN rail to ensure proper grounding. The use of other DIN rail materials (for example, aluminum or plastic) that can corrode, oxidize, or are poor conductors, can result in improper or intermittent grounding. Secure DIN rail to mounting surface approximately every 200 mm (7.8 in.) and use end-anchors appropriately. Be sure to ground the DIN rail properly. See Industrial Automation Wiring and Grounding Guidelines, Rockwell Automation publication [1770-4.1](#), for more information.

Before You Begin

To use your adapter effectively, note the following considerations.

- Understand Messaging**
 Class 3 (Explicit Message) requests through the 1734-ACNR or 1734-ACNRK adapter to a specific POINT I/O module may not always receive a response from the I/O module. In the case where the I/O module does not reply to the request, the adapter responds with an error code indicating a timeout.
- Establish I/O Connections**
 When you power up a POINT I/O system and establish I/O connections, the outputs transition to the Idle state, applying Idle state data before going to RUN mode. This occurs even when the controller making the connection is already in RUN mode.
- Configure Autobaud**
 The adapter cannot reconfigure an I/O module that you previously configured to operate at a fixed baud rate. When you reuse a POINT I/O module from another POINT I/O system, configure the module to autobaud before using it with the 1734-ACNR or 1734-ACNRK adapter.

Install the ControlNet Adapter



ATTENTION: You must use series C POINT I/O modules with the 1734-ACNR or 1734-ACNRK adapter. Series A and B POINT I/O modules will not work with the 1734-ACNR or 1734-ACNRK adapter.

To install the adapter on the DIN rail before installing other base units, proceed as follows:

1. Position the adapter vertically above the DIN rail.
2. Press down firmly to install the adapter on the DIN rail.
The locking mechanism locks the adapter to the DIN rail.
3. Set the node address on the node address thumbwheel.



WARNING: When you insert or remove the module while backplane power is on, an electric arc can occur. This could cause an explosion in hazardous location installations.

Be sure that power is removed or the area is nonhazardous before proceeding. Repeated electrical arcing causes excessive wear to contacts on both the module and its mating connector. Worn contacts may create electrical resistance that can affect module operation.

4. Remove the safety end cap by sliding it up. This exposes the backplane and power interconnections.



ATTENTION: Do not discard the end cap. Use this end cap to cover the exposed interconnections on the last mounting base on the DIN rail. Failure to do so could result in equipment damage or injury from electric shock.

Set the Node Address

Set the node address using the 2-position thumbwheel switch. Valid settings range from 01...99. Press the + or - buttons to change the number.

Network Node Address Thumbwheel

Network node address pen push thumbwheel -
Press the **center** of either the + or - buttons to change the number.

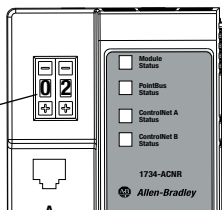

WARNING: When you change switch settings while power is on, an electric arc can occur. This could cause an explosion in hazardous location installations. Be sure that power is removed or the area is nonhazardous before proceeding.

Install a Replacement ControlNet Adapter to an Existing System



ATTENTION: You must use series C POINT I/O modules with the 1734-ACNR or 1734-ACNRK adapter. Series A and B POINT I/O modules does not work with the 1734-ACNR or 1734-ACNRK adapter.



WARNING: When you connect or disconnect the RTB with field side power applied, an electric arc can occur. This could cause an explosion in hazardous location installations. Be sure that power is removed or the area is nonhazardous before proceeding.

Remove the existing adapter from the DIN rail as follows:

1. Disconnect the ControlNet connector from the adapter.
2. Pull up on the RTB removal handle to remove the RTB.
3. Remove the adjacent module from its base.
4. Use a small bladed screwdriver to rotate the DIN rail locking screw to a vertical position. This releases the locking mechanism.
5. Lift straight up to remove.

Install the replacement adapter on the DIN rail as follows:

1. Remove the safety end cap on the replacement adapter by sliding it up. This exposes the backplane and power connections.
2. Position the replacement adapter vertically above the DIN rail.

- Verify that the DIN rail lock is in the horizontal position.
- 3. Slide the adapter down so that the interlocking side pieces engage the adjacent module.
- 4. Press firmly to seat the adapter on the DIN rail.
The adapter locking mechanism snaps into place.
- 5. Set the node address on the node address thumbwheel.
- 6. Insert the end opposite the handle into the base unit.
This end has a curved section that engages with the wiring base.
- 7. Rotate the RTB into the wiring base until it locks itself into place.
- 8. Replace the adjacent module in its base.
- 9. Connect the ControlNet cable to the adapter.
Use a tap to connect the adapter to the ControlNet cable. Do not directly connect the adapter to the coax cable.

Wire the ControlNet Adapter

To wire the adapter, see the diagrams and tables.

Figure 2 - Adapter Wiring

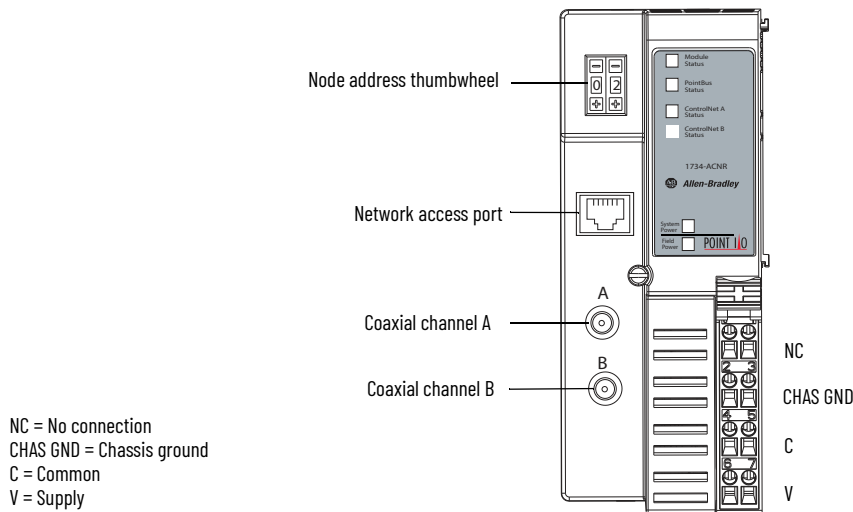

WARNING: The NAP port is intended for temporary local programming purposes only and requires the use of a 1786-CP cable assembly. The NAP is not intended for permanent connection. If you connect or disconnect the NAP cable with power applied to this module or any device on the USB network, an electric arc can occur. This could cause an explosion in hazardous location installations. Be sure that power is removed or the area is nonhazardous before proceeding.

Figure 3 - 12/24V DC Wiring

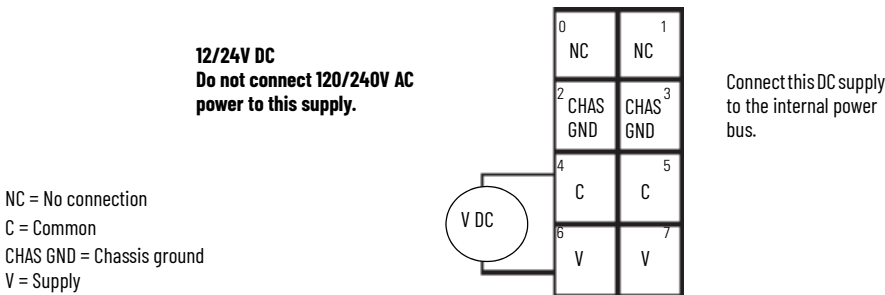

ATTENTION: Do not wire more than 2 conductors on any single terminal.



WARNING: If you connect or disconnect wiring while the field-side power is on, an electric arc can occur. This could cause an explosion in hazardous location installations. Be sure that power is removed or the area is nonhazardous before proceeding.

Interpret the Status Indicators

Figure 4 and Table 1 show the status indicators to troubleshoot your adapter.

Figure 4 - Status Indicators for 1734-ACNR and 1734-ACNRK Adapters

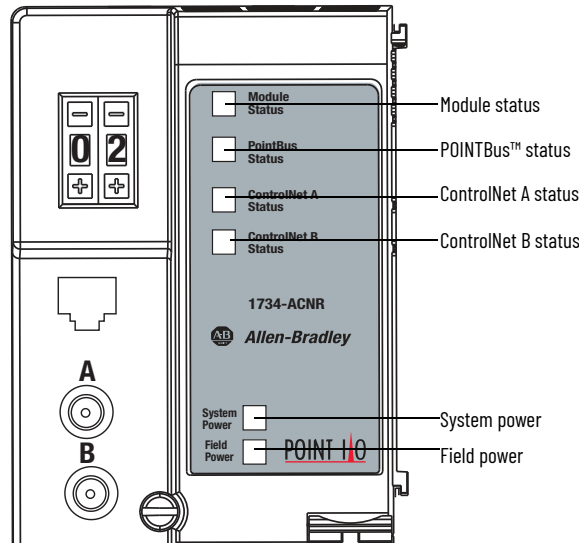

Table 1 - Interpret the Status Indicators

Indicator	Status	Description
Field power	Off	Not active Field power is off.
	Green	Power is on. 24V is present.
System power	Off	Not active Field power is off. DC-DC converter problem exists.
	Green	System power is on. DC-DC converter is active (5V).
Module status	Off	No power is applied to the device.
	Alternating red/green	LED powerup test (module self-test) is in progress.
	Flashing red	A recoverable fault has occurred: <ul style="list-style-type: none"> Firmware (NVS) update MAC ID changed CPU load exceeded
	Steady red	An unrecoverable fault has occurred: <ul style="list-style-type: none"> Self test failure (checksum failure at powerup, ramtest failure at powerup) Firmware fatal error
	Flashing green	Waiting for connection or a ControlNet cable break is present
	Steady green	The module is operating correctly (normal mode).
ControlNet A/B status Viewed together	Both steady off	Reset, no power, or entire network interface is deactivated.
	Alternating red/green	The module is in self test mode.
	Alternating red/off	Bad or invalid node configuration (such as duplicate MAC ID) is present.
ControlNet A/B status Viewed individually	Both steady red	Failed link interface has occurred.
	Steady off	The channel is disabled or the channel is not supported.
	Flashing red/green	Invalid link configuration
	Flashing red/off	Severe link error - Link has faulted or no MAC frames is received.
	Flashing green/off	A temporary channel error has occurred or in listen-only mode.
Steady green	Normal operation - MAC frames are being received without detected errors.	

Table 1 - Interpret the Status Indicators (Continued)

Indicator	Status	Description
POINTBus status	Off	The device is not powered. Check the module status indicator.
	Alternating red/green	LED power up test in progress.
	Flashing red	A recoverable fault has occurred: <ul style="list-style-type: none"> The number of expected modules does not equal the number of modules present at power up. A module is missing. Node fault occurred (I/O connection timeout).
	Red	An unrecoverable fault has occurred: <ul style="list-style-type: none"> The adapter is bus off. The adapter has failed its duplicate MAC ID check.
	Flashing green	The adapter is online with no connections established: <ul style="list-style-type: none"> The adapter chassis size has not been configured. The controller is in Program/Idle mode. There is a ControlNet cable break.
	Green	The adapter is online with connections established (normal operation, in run mode).

Specifications

POINT I/O ControlNet Adapter - 1734-ACNR, 1734-ACRNK

Attribute	Value
Number of nodes, max	1
Module location	Starter module - Left side of POINT I/O system
Input voltage rating, nom	24V DC
Input voltage rating range	10...28.8V DC
Isolation voltage	50V (continuous), Basic insulation type Type tested at 750V AC for 60 s, comm to system, user power to system, user power to comm, and all circuits to chassis ground.

General Specifications

Attribute	Value
Dimensions (HxWxD), approx.	76.2 x 54.9 x 133.4 mm (3.0 x 2.16 x 5.25 in.)
Weight, approx.	255 g (9 oz)
Network name	ControlNet
Termination type	None
Electronic protection	No
Diagnostics	No
Enclosure type rating	None (open-style)
Platform/processor compatibility	1747, 1756, 1761, 1762, 1764, 1789, 1794
Communication interface type	Adapter
Device type	Communication interface
Input byte capacity	248
Output byte capacity	248
Power supply 24V current load	425 mA
Field-side power requirements max	24V DC (+20% = 28.8V DC) @ 425 mA
Interruption protection	The output voltage stays within specifications when the input drops out for 10 ms at 10V with max load.
Field power bus, nominal voltage	24V DC
Field power bus, supply voltage range	10...28.8V DC
Field power bus, supply current, max	10 A
Operating voltage range	10...28.8V DC
Wire size Power wiring ⁽¹⁾	0.25...2.5 mm ² (22...14 AWG) solid or stranded copper wire rated at 75 °C (167 °F), or greater. 1.2 mm (3/64 in.) insulation max
Wire category ⁽²⁾	1 on power ports 2 on communications ports
Terminal base screw torque	0.6 N•m (7 lb•in)
POINTBus output current, max	1 A @ 5V DC +5% (4.75...5.25V DC)
Input overvoltage protection	Reverse polarity protected
Power consumption	10.2 W @ 28.8V DC
Power dissipation, max	5.0 W @ 28.8V
Thermal dissipation, max	16.9 BTU/hr @ 28.8V DC
North American temp code	T4A
UKEX/ATEX temp code	T4
IECEx temp code	T4

(1) For information on ControlNet wire size, see ControlNet Coax Media Planning and Installation Guide Installation Instructions, publication [CNET-IN002](#).

(2) Use this Conductor Category information for planning conductor routing. See Industrial Automation Wiring and Grounding Guidelines, publication [1770-4.1](#).

Power Supply

Attribute	Value
Input voltage rating, nom	24V DC
Input voltage range	10...28.8V DC
Field-side power requirements, max	24V DC (+20% = 28.8V DC) @ 425 mA
Inrush current, max	6 A for 10 ms
Interruption	The output voltage stays within specifications when the input drops out for 10 ms at 10V with max load.

1734-ACNR, 1734-ACNRK Communication Interface

Attribute	Value																																																																																												
Expansion I/O capacity	Up to 17 modules, dependent on backplane bus current draw (17 X 75 mA = 1.275 A, just under the limit of 1.3 A). The actual number of modules can vary. Add up the current requirements of the modules you want to use to make sure they do not exceed the amperage limit of the 1734-ACNR or 1734-ACNRK adapter.																																																																																												
Expansion I/O capacity	<table border="1"> <thead> <tr> <th>Catalog Number</th> <th>POINTBus Current Requirements</th> <th>Catalog Number</th> <th>POINTBus Current Requirements</th> </tr> </thead> <tbody> <tr><td>1734-IB2</td><td>75 mA</td><td>1734-OW4</td><td>80 mA</td></tr> <tr><td>1734-IB4</td><td>75 mA</td><td>1734-0X2</td><td>100 mA</td></tr> <tr><td>1734-IB4D</td><td>50 mA</td><td>1734-IE2C</td><td>75 mA</td></tr> <tr><td>1734-IB8</td><td>75 mA</td><td>1734-OE2C</td><td>75 mA</td></tr> <tr><td>1734-IB2</td><td>75 mA</td><td>1734-IE2V</td><td>75 mA</td></tr> <tr><td>1734-IB4</td><td>75 mA</td><td>1734-OE2V</td><td>75 mA</td></tr> <tr><td>1734-IB4D</td><td>50 mA</td><td>1734-IA2</td><td>75 mA</td></tr> <tr><td>1734-IB8</td><td>75 mA</td><td>1734-IA4</td><td>75 mA</td></tr> <tr><td>1734-IV2</td><td>75 mA</td><td>1734-IM2</td><td>75 mA</td></tr> <tr><td>1734-IV4</td><td>75 mA</td><td>1734-IM4</td><td>75 mA</td></tr> <tr><td>1734-IV8</td><td>75 mA</td><td>1734-OA2</td><td>75 mA</td></tr> <tr><td>1734-OB2</td><td>75 mA</td><td>1734-OA4</td><td>75 mA</td></tr> <tr><td>1734-OB4</td><td>75 mA</td><td>1734-IJ</td><td>160 mA</td></tr> <tr><td>1734-OB8</td><td>75 mA</td><td>1734-IK</td><td>160 mA</td></tr> <tr><td>1734-OB2E</td><td>75 mA</td><td>1734-IR2</td><td>220 mA</td></tr> <tr><td>1734-OB2EP</td><td>75 mA</td><td>1734-IR2E</td><td>220 mA</td></tr> <tr><td>1734-OB4E</td><td>75 mA</td><td>1734-IT2I</td><td>175 mA</td></tr> <tr><td>1734-OB8E</td><td>75 mA</td><td>1734-SSI</td><td>110 mA</td></tr> <tr><td>1734-OV2E</td><td>75 mA</td><td>1734-VHSC5</td><td>180 mA</td></tr> <tr><td>1734-OV4E</td><td>75 mA</td><td>1734-VHSC24</td><td>180 mA</td></tr> <tr><td>1734-OV8E</td><td>75 mA</td><td>1734-232ASC</td><td>75 mA</td></tr> <tr><td>1734-OW2</td><td>80 mA</td><td>1734-485ASC</td><td>75 mA</td></tr> </tbody> </table>	Catalog Number	POINTBus Current Requirements	Catalog Number	POINTBus Current Requirements	1734-IB2	75 mA	1734-OW4	80 mA	1734-IB4	75 mA	1734-0X2	100 mA	1734-IB4D	50 mA	1734-IE2C	75 mA	1734-IB8	75 mA	1734-OE2C	75 mA	1734-IB2	75 mA	1734-IE2V	75 mA	1734-IB4	75 mA	1734-OE2V	75 mA	1734-IB4D	50 mA	1734-IA2	75 mA	1734-IB8	75 mA	1734-IA4	75 mA	1734-IV2	75 mA	1734-IM2	75 mA	1734-IV4	75 mA	1734-IM4	75 mA	1734-IV8	75 mA	1734-OA2	75 mA	1734-OB2	75 mA	1734-OA4	75 mA	1734-OB4	75 mA	1734-IJ	160 mA	1734-OB8	75 mA	1734-IK	160 mA	1734-OB2E	75 mA	1734-IR2	220 mA	1734-OB2EP	75 mA	1734-IR2E	220 mA	1734-OB4E	75 mA	1734-IT2I	175 mA	1734-OB8E	75 mA	1734-SSI	110 mA	1734-OV2E	75 mA	1734-VHSC5	180 mA	1734-OV4E	75 mA	1734-VHSC24	180 mA	1734-OV8E	75 mA	1734-232ASC	75 mA	1734-OW2	80 mA	1734-485ASC	75 mA
Catalog Number	POINTBus Current Requirements	Catalog Number	POINTBus Current Requirements																																																																																										
1734-IB2	75 mA	1734-OW4	80 mA																																																																																										
1734-IB4	75 mA	1734-0X2	100 mA																																																																																										
1734-IB4D	50 mA	1734-IE2C	75 mA																																																																																										
1734-IB8	75 mA	1734-OE2C	75 mA																																																																																										
1734-IB2	75 mA	1734-IE2V	75 mA																																																																																										
1734-IB4	75 mA	1734-OE2V	75 mA																																																																																										
1734-IB4D	50 mA	1734-IA2	75 mA																																																																																										
1734-IB8	75 mA	1734-IA4	75 mA																																																																																										
1734-IV2	75 mA	1734-IM2	75 mA																																																																																										
1734-IV4	75 mA	1734-IM4	75 mA																																																																																										
1734-IV8	75 mA	1734-OA2	75 mA																																																																																										
1734-OB2	75 mA	1734-OA4	75 mA																																																																																										
1734-OB4	75 mA	1734-IJ	160 mA																																																																																										
1734-OB8	75 mA	1734-IK	160 mA																																																																																										
1734-OB2E	75 mA	1734-IR2	220 mA																																																																																										
1734-OB2EP	75 mA	1734-IR2E	220 mA																																																																																										
1734-OB4E	75 mA	1734-IT2I	175 mA																																																																																										
1734-OB8E	75 mA	1734-SSI	110 mA																																																																																										
1734-OV2E	75 mA	1734-VHSC5	180 mA																																																																																										
1734-OV4E	75 mA	1734-VHSC24	180 mA																																																																																										
1734-OV8E	75 mA	1734-232ASC	75 mA																																																																																										
1734-OW2	80 mA	1734-485ASC	75 mA																																																																																										
Communication rate max	128K bit/s (500 m) 250K bit/s (250 m) 500K bit/s (100 m)																																																																																												

Environmental Specifications

Attribute	Value
Temperature, operating	IEC 60068-2-1 (Test Ad, operating cold), IEC 60068-2-2 (Test Bd, operating dry heat), IEC 60068-2-14 (Test Nb, operating thermal shock) -20 °C ≤ Ta ≤ +55 °C (-4 °F ≤ Ta ≤ +131 °F)
Temperature, nonoperating	IEC60068-2-1 (Test Ab, unpackaged nonoperating cold) IEC60068-2-2 (Test Bb, unpackaged nonoperating dry heat) IEC60068-2-14 (Test Na, unpackaged nonoperating thermal shock) -40...+85 °C (-40...+185 °F)
Temperature, surrounding air, max	55 °C (131 °F)
Relative humidity	IEC60068-2-30 (Test Db, unpackaged damp heat) 5...95% noncondensing
Vibration	IEC 60068-2-6 (Test Fc, operating): 5 g @ 10...500 Hz
Shock, operating	IEC60068-2-27 (Test Ea, unpackaged shock): 30 g
Shock, nonoperating	IEC60068-2-27 (Test Ea, unpackaged shock): 50 g
Emissions	IEC 61000-6-4
ESD immunity	IEC6100-4-2: 6 kV contact discharges 8 kV air discharges
Radiated RF immunity	IEC 61000-4-3: 10V/m with 1 kHz sine-wave 80% AM from 80...6000 MHz
EFT/B immunity	IEC 61000-4-4: ±4 kV at 2.5 kHz on power ports ±2 kV at 5 kHz on communications ports
Surge transient immunity	IEC 61000-4-5: ±1 kV line-line(DM) and ±2 kV line-earth(CM) on power ports ±2 kV line-earth(CM) on communications ports
Conducted RF immunity	IEC61000-4-6 10V rms with 1 kHz sine-wave 80%AM from 150 kHz...80 MHz

Certifications

Certification (when product is marked) ⁽¹⁾	Value
c-UL-us	UL Listed Industrial Control Equipment, certified for US and Canada. See UL File E65584. UL Listed for Class I Division 2 Group A,B,C,D Hazardous Locations, certified for U.S. and Canada. See UL File E194810.
UK and CE	UK Statutory Instrument 2016 No. 1091 and European Union 2014/30/EU EMC Directive, compliant with: EN 61326-1; Measurement/Control/Laboratory use, Industrial requirements EN 61000-6-2; Industrial Immunity EN 61000-6-4; Industrial Emissions EN 61131-2; Programmable Controllers (Clause 8, Zone A & B) UK Statutory Instrument 2012 No. 3032 and European Union 2011/65/EU RoHS, compliant with: EN IEC 63000; Technical documentation
RCM	Australian Radiocommunications Act, compliant with: AS/NZS CISPR 11; Industrial Emissions
Ex	UK Statutory Instrument 2016 No. 1107 and European Union 2014/34/EU ATEX Directive, compliant with: EN IEC 60079-0; General Requirements EN IEC 60079-7; Explosive Atmospheres, Protection "e" II 3 G Ex ec IIC T4 Gc DEMKO 04 ATEX 0330347X UL22UKEX2478X
IECEX	IECEX System, compliant with: IEC 60079-0; General Requirements IEC 60079-7; Explosive Atmospheres, Protection "e" II 3 G Ex ec IIC T4 Gc IECEX UL 20.0072X
KC	Korean Registration of Broadcasting and Communications Equipment, compliant with: Article 58-2 of Radio Waves Act, Clause 3
Morocco	Arrêté ministériel n° 6404-15 du 29 ramadan 1436
CCC	CNCA-C23-01 强制性产品认证实施规则 防爆电气 CNCA-C23-01 CCC Implementation Rule Explosion-Proof Electrical Products CCC: 202012230911607
ControlNet	ControlNet International conformance tested to ControlNet specifications

(1) See the Product Certifications link at rok.auto/certifications for Declaration of Conformity, Certificates, and other certification details.

Additional Resources

These documents contain additional information concerning related products from Rockwell Automation. You can view or download publications at rok.auto/literature.

Resource	Description
POINT I/O Modules Selection Guide, publication 1734-SG001	Provides information to help you select POINT I/O adapters, I/O modules, wiring base assemblies, power supplies, and accessories, based on your requirements.
POINT I/O ControlNet Adapter User Manual, publication 1734-UM008	Describes how to install, configure, and operate the POINT I/O ControlNet adapter.
Industrial Automation Wiring and Grounding Guidelines, publication 1770-4.1	Provides general guidelines for installing a Rockwell Automation industrial system.
Product Certifications website, rok.auto/certifications	Provides declarations of conformity, certificates, and other certification details.

Rockwell Automation Support

Use these resources to access support information.

Technical Support Center	Find help with how-to videos, FAQs, chat, user forums, Knowledgebase, and product notification updates.	rok.auto/support
Local Technical Support Phone Numbers	Locate the telephone number for your country.	rok.auto/phonesupport
Technical Documentation Center	Quickly access and download technical specifications, installation instructions, and user manuals.	rok.auto/techdocs
Literature Library	Find installation instructions, manuals, brochures, and technical data publications.	rok.auto/literature
Product Compatibility and Download Center (PCDC)	Download firmware, associated files (such as AOP, EDS, and DTM), and access product release notes.	rok.auto/pcdc

Documentation Feedback

Your comments help us serve your documentation needs better. If you have any suggestions on how to improve our content, complete the form at rok.auto/docfeedback.





Waste Electrical and Electronic Equipment (WEEE)



At the end of life, this equipment should be collected separately from any unsorted municipal waste.

Rockwell Automation maintains current product environmental compliance information on its website at rok.auto/pec.

Rockwell Otomasyon Ticaret A.Ş. Kar Plaza İş Merkezi E Blok Kat:6 34752 İçerenköy, İstanbul, Tel: +90 (216) 5698400 EEE Yönetmeliğine Uygundur

Connect with us.    

rockwellautomation.com — expanding **human possibility**

AMERICAS: Rockwell Automation, 1201 South Second Street, Milwaukee, WI 53204-2496 USA, Tel: (1) 414.382.2000

EUROPE/MIDDLE EAST/AFRICA: Rockwell Automation NV, Pegasus Park, De Kleetlaan 12a, 1831 Diegem, Belgium, Tel: (32) 2663 0600

ASIA PACIFIC: Rockwell Automation SEA Pte Ltd, 2 Corporation Road, #04-05, Main Lobby, Corporation Place, Singapore 618494, Tel: (65) 6510 6608

UNITED KINGDOM: Rockwell Automation Ltd., Pitfield, Kiln Farm, Milton Keynes, MK11 3DR, United Kingdom, Tel: (44)(1908) 838-800

Allen-Bradley, expanding human possibility, POINT I/O, POINTBus, Rockwell Automation, and TechConnect are trademarks of Rockwell Automation, Inc.

ControlNet is a trademark of ODVA, Inc.

Trademarks not belonging to Rockwell Automation are property of their respective companies.

Publication 1734-IN582D-EN-P - September 2024 | Supersedes Publication 1734-IN582C-EN-P - June 2023

Copyright © 2024 Rockwell Automation, Inc. All rights reserved. Printed in Singapore.

PN-729212