

LET US KNOW WHAT YOU THINK

We sincerely thank you for your business and are committed to ensuring your full satisfaction. If you are not entirely satisfied for whatever reason, please reach out to us and we will do all within our power

If your experience has been something less than amazing, please drop us an email at amcrest.com/contact or give us a ring at **1-888-212-7538**



facebook.com/amcrest



amcrest.com/videos



twitter.com/amcrestsecurity



amcrest.com/support



Instagram.com/amcresttechnologies



Simple. Reliable. Secure.



Simple. Reliable. Secure.

Welcome to the Amcrest Family!

QUICK START GUIDE

12MP POE FISHEYE CAMERA SETUP

For the most recent version of this Quick Start Guide visit:

amcrest.com/support

www.amcrest.com



THANK YOU FOR PURCHASING AN AMCREST CAMERA!



PHYSICAL INSTALLATION



HARDWARE SETUP

Please follow the instructions in this Quick Start Guide to get your camera set up.

Physical Installation	2
MicroSD Card Installation	
Physical Installation	
Device Initialization	6
Initial Setup	
Set Up Your Camera with Amcrest View Pro	7
POE Camera Setup	
Device Search	
Set Up Your Camera with Amcrest Cloud	13
Setup your camera using Amcrest premium cloud service.	
Desktop Software	19
Amcrest Blue Iris	
Professional surveillance software that allows you to view, playback and record up to 64 cameras.	
Amcrest Surveillance Pro	
Free professional surveillance software used to monitor your camera via a computer without a web browser.	
Alternative Access Methods	20
Troubleshooting/FAQ	21
Frequently asked questions as well as helpful tips when setting up your camera.	
Information & Links	23
Contact information and useful links for additional information.	
FCC Compliance Statement	24
Provides insight into the FCC compliance statement for all Amcrest cameras.	

What's Included?

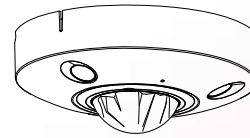

Fisheye Camera

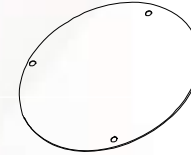

Installation Sticker

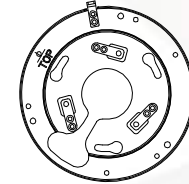

Installation Plate



Screws & Wall Anchors

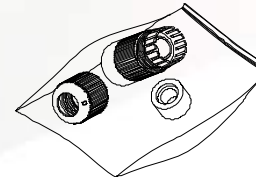

Ethernet Protectors (Optional)

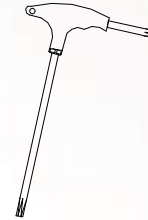

Torx Wrench



Locking Screw (Optional)



MICROSD CARD INSTALLATION



Install a microSD card to access and store recordings locally. The camera supports a max of 256GB. A Phillips head screwdriver will be required to install the microSD card into the camera.

HARDWARE SETUP

1

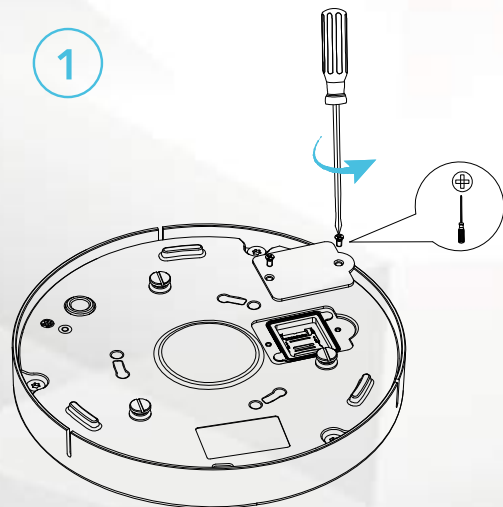

Locate the hatch on the bottom of the camera and remove it using a Phillips head screwdriver.

2

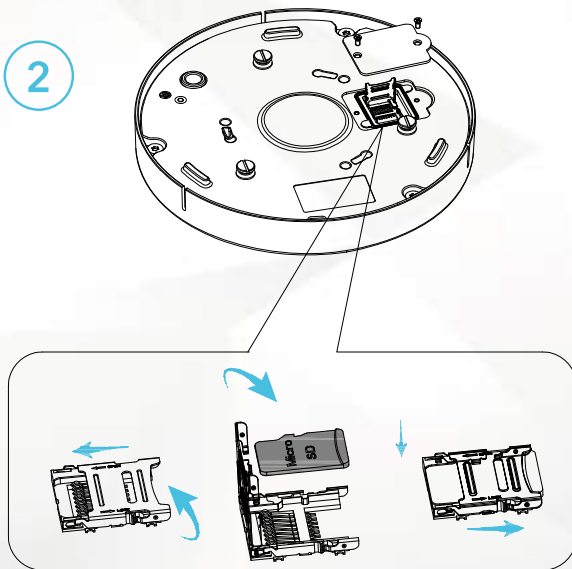

Open the microSD card clasp and place the microSD card into the slot. Place the clasp over the microSD card and slide back to secure the card. Secure the hatch back to the camera.



PHYSICAL INSTALLATION



HARDWARE SETUP

1

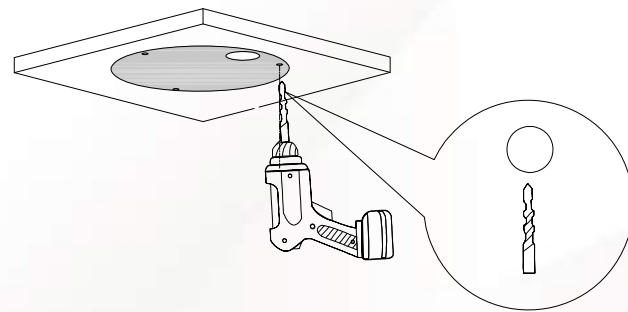

Place the installation sticker only the mounting surface and drill the holes.

2

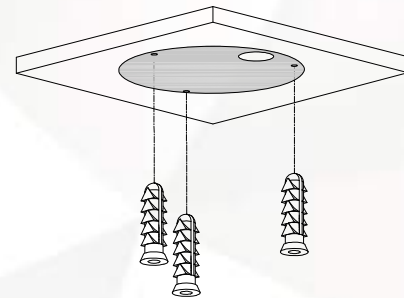

Insert the wall anchors into the newly drilled holes.



It is recommended to connect using a POE+ switch with an Ethernet cable. However, the camera may also be powered using a DC12V power adapter if a POE+ switch is not available.



PHYSICAL INSTALLATION, CONT.



HARDWARE SETUP

3

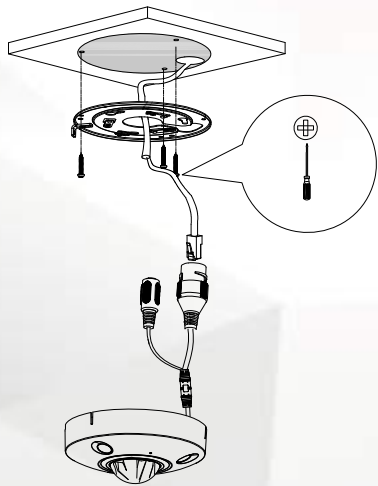

Align the wall anchor holes to the holes found on the installation plate. Secure the installation plate to the mounting surface using a Phillips head screwdriver. Connect the applicable wiring (Ethernet, etc.) to the camera.

4

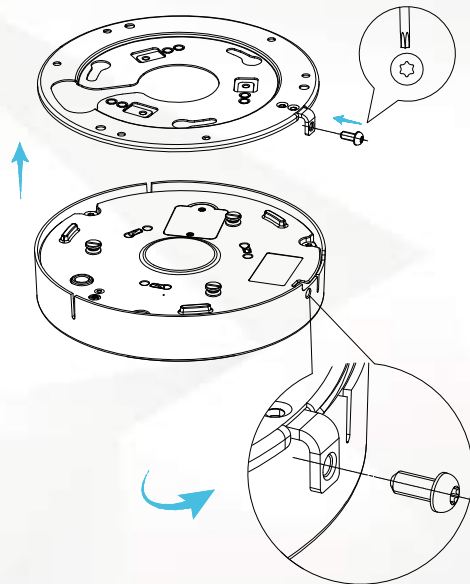

Align the screws on the back of the camera to the installation plate and twist to secure. Insert the security screw into the side of the plate and use the included torx wrench to secure.



DEVICE INITIALIZATION



INITIAL SETUP

2



The device must be initialized before it can be accessed on other platforms such as the Amcrest View Pro app or other services.

- Make sure the camera is powered on and receiving data from the network.
- Make sure the computer and camera are on the same network.

1



Download and install the Amcrest IP config tool on your computer. The software is available for Windows or Mac and can be found at amcrest.com/downloads.

Available for
Windows

Available for
Mac



Locate the IP address for the camera and enter it into a web browser.



For access to a full user manual please visit: amcrest.com/support

SETUP YOUR CAMERA WITH AMCREST VIEW PRO

AMCREST VIEW PRO POE CAMERA SETUP



Recommended setup procedure for adding a POE camera to Amcrest View Pro.

- Make sure the camera has been initialized **before** adding it into the Amcrest View Pro app.
- Make sure your camera and mobile device are on the same network during setup.

1



Download and open the Amcrest View Pro app from the App Store or Play Store.



Android users using Android 8.0 and above and iOS users using iOS 13.0 and above please allow location access to allow the app to access network

2

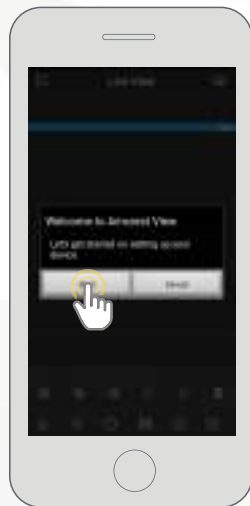

Once all permissions have been allowed, tap the **Start** button.

3

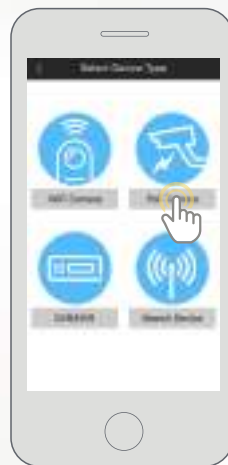

Tap **PoE Camera**.

4



Next, we will need to select a connection type. Since we will be setting up a basic P2P connection with the device, tap on **"P2P Connection"** to continue.

Note: On Android mobile devices, tap on **P2P Setup**.



5



Scan the QR code  on the back of the camera or manually enter the camera's serial number into the **Enter camera S/N** (serial number) field. Press **Next** to continue.

Android users, please verify the S/N on your device has been properly scanned. Tap **Next** to continue.

6

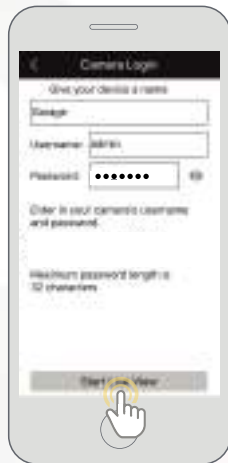

Give the camera a name (e.g. Garage, Kitchen, Living Room, etc.) and provide the username and password for your camera. Tap **Start Live View** to view the camera.

Note: You can tap on the  icon to verify the password.



2

Secondary setup procedure for adding a POE camera to Amcrest View Pro.

- Make sure the camera has been initialized **before** adding it into the Amcrest View Pro app.
- Make sure your camera and mobile device are on the same network during setup.

1



Download and open the Amcrest View Pro app from the App Store or Play Store.



Android users using Android 8.0 and above and iOS users using iOS 13.0 and above must allow location access to allow the app to access network connected devices.

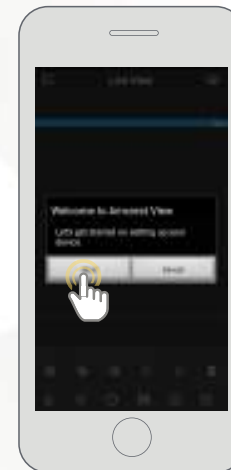

Once all permissions have been allowed, tap the **Start** button.



3



Tap **Search Device**.

4



The app will automatically begin scanning your network for your device. When the list has finished loading, select your device from the list and tap on **Connection Type**.



5

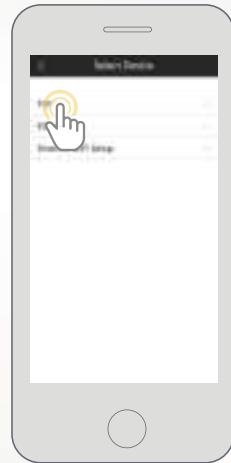

Tap on **P2P**

Note: If you are setting up your camera remotely using IP/Domain, tap on IP/Domain. For more information on setting up IP/Domain visit: amcrest.com/ipdomainddnssetup

6



Give the camera a name (e.g. Garage, Kitchen, Living Room, etc.) and provide the username and password for your camera. Tap **Start Live View** to view the camera.

Note: You can tap on the  icon to verify the password.

GET THE PREMIUM MONITORING EXPERIENCE WITH AMCREST CLOUD



Amcrest Cloud



Amcrest View Pro

VIDEO STORAGE

Secure off-site Cloud Storage

MicroSD card
(most models)

MULTI-VIEW CAMERA EXPERIENCE

View unlimited cameras simultaneously

View up to
16 Cameras

EXTRA FEATURES

+ Alexa Support	+ Camera Health	+ Push Notifications	+ Two-Way
+ Email Alerts	+ Motion Detection	+ Motion Detection	+ MicroSD
+ Push Notifications	+ Direct Video Download	+ Email Alerts	+ NVR Recording <small>*NVR not included</small>

PRICING

Free Plan - Unlimited Live Viewing (No Storage)

FOREVER FREE



For more details on Amcrest Cloud including prices on cloud storage plans, please visit amcrest.com/cloud

SETUP YOUR CAMERA WITH AMCREST CLOUD

2

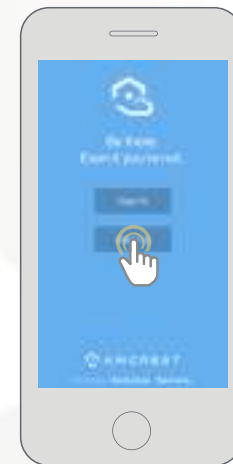

AMCREST CLOUD MOBILE SETUP



Setup procedure for adding a camera to Amcrest Cloud.

- Make sure the camera has been initialized **before** adding it into the Amcrest Cloud.
- Make sure your camera and mobile device are on the same network during setup.

1

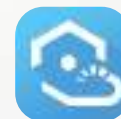

Download and open the Amcrest Cloud app from the App Store or Play Store.



Once you have downloaded the Amcrest Cloud app, open the app and allow all notifications.

Press **Sign Up** to create a new Amcrest Cloud account. If you have already signed up for Amcrest Cloud, login and skip to step 5.



3

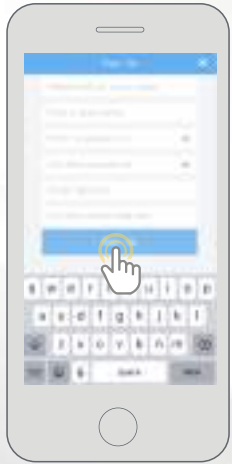

To sign up for an Amcrest Cloud account, enter your name, and choose a username and password for the cloud account. Enter the password again into the **Confirm password** section.

Next, enter your email address. This will be the email address that will be associated with your cloud account. Enter the same email address into the **Confirm email address** section and press the **Sign Up** button when you are done.

4



Accept the terms of use for the account. To view the terms of use, click on **View Terms**. Tap on **Agree** to accept the terms of use and proceed with Amcrest Cloud setup.

5

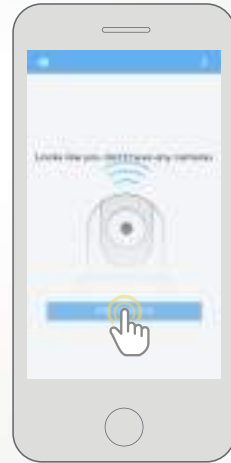

Tap on **Add Camera**.

6

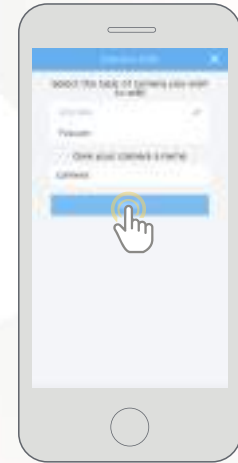

Give the camera a name (Ex. Garage, Living Room, Kitchen, etc.) and tap **Next** to continue.





7



Scan the QR code  on the back/side/bottom of the camera or manually enter the camera's serial number into the **Enter camera S/N** (serial number) field. Press **Next** to continue.

Note: On Android mobile devices, tap on Scan QR Code to access the QR code reader.

8

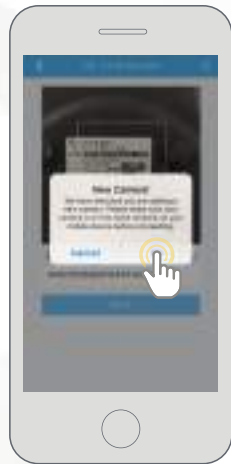

If you are adding a new camera that does not have a set password the app will automatically detect that a new camera is being added. Tap on **OK** to continue.

If you already have a set password for your camera, enter the username and password, press **Next**, and skip to step 10.



9

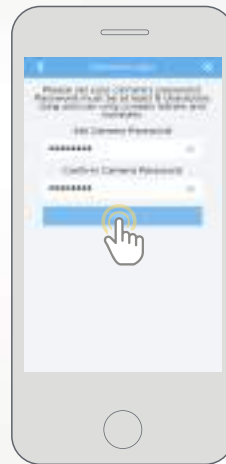

Set a new password for your device. The password must be between 8 to 32 characters long and contain only letters and numbers.

When you have finished setting the password, enter the password again in the **Confirm Camera Password** section. Tap **Next** to continue.

10

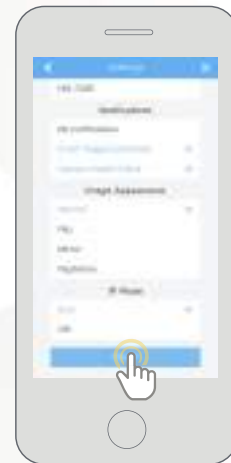

Confirm and adjust any needed settings for your camera. When all settings have been confirmed, tap **Finish**.



DESKTOP SOFTWARE



For more information on AI camera based desktop access and ways to setup your camera please visit, amcrest.com/support

1

AMCREST BLUE IRIS

Amcrest Blue Iris is a professional Windows based surveillance software that allows you to view and record up to 64 IP cameras, or DVR/CCTV based cameras simultaneously. It is a third-party software that is compatible with a vast majority of IP camera and DVR/NVR brands.

To purchase Amcrest Blue Iris, please visit: amcrest.com/blueiris

2

AMCREST SURVEILLANCE PRO

Amcrest Surveillance Pro is a free professional surveillance software provided by Amcrest that allows users access to their cameras from a Windows or Mac device without the use of a web browser or plugin. Please note, if adding you are adding your AI camera into the Amcrest Surveillance Pro software certain AI features may not be available. Therefore, it is highly recommended to access your camera using a web browser .

For more information on Amcrest Surveillance Pro, visit: amcrest.com/surveillancepro



ALTERNATIVE ACCESS METHODS



For additional access methods, refer to the alternative access methods provided below.

1

CLOUD DESKTOP SETUP

This setup method will be used for setting up your camera on the cloud via a web browser on a PC or laptop. For more information on cloud desktop setup visit:

amcrest.com/cloudwebsetup

2

ADDING ALREADY SETUP CAMERAS

The P2P setup method will be used for setting up already connected devices to the Amcrest View Pro app. For more information on P2P setup, visit:

amcrest.com/p2psetup

3

IP/DOMAIN/DDNS SETUP

The IP/Domain/DDNS Setup method will be used to establish a direct connection without using P2P. For more information on IP/Domain/DDNS setup, visit:

amcrest.com/ipdomainddnssetup

ALTERNATIVE ACCESS METHODS



For additional setup methods for your Amcrest camera, refer to the alternative setup methods provided below.

6

AMCRESTVIEW.COM SETUP

This setup method will be used to setup a amcrestview.com connection for your device. The web page will connect via a P2P method through a designated web interface. For more information on how to setup a connection using amcrestview.com, visit:

amcrest.com/amcrestviewsetup

7

REMOTE ACCESS DESKTOP SETUP

This setup method will be used for establishing and accessing your device remotely, via a web interface, on a desktop or laptop. For more information on local access desktop setup, visit:

amcrest.com/remotewebsetup



For more information on Alternative Access Methods visit, amcrest.com/support

TROUBLESHOOTING/FAQ



HOW DO I USE THE AI FEATURES FOR MY CAMERA?

The camera comes with built in AI features such as people counting, queuing, and IVS which work to provide more adequate security and analytics to a detection area. People counting and queuing use an advanced algorithm to count the number or threshold of people in a specified area and display the results graphically. IVS is used to provide advanced perimeter protection with the use of such rules as a tripwire or intrusion area. Please note, people counting and IVS rules cannot be enabled at the same time and will require a separate smart plan to function.

For more details on AI features including setup, etc. please visit amcrest.com/support



HOW DO I VIEW MY AI RECORDINGS?

To view recordings from your camera a microSD card (class 10 or above, formatted to FAT32) will need to be installed. Recordings from a microSD card can be viewed in the web user interface under playback via a web browser or using the Amcrest View Pro app. However, for more detailed reporting of a detected AI event such as accessing people counting reports, IVS, etc. you can access the report tab which can be found in the AI menu in a web browser.

For more information on how to view AI recordings, please visit: amcrest.com/support

INFORMATION & LINKS

Contact our customer service team

amcrest.com/contact

USA Toll Free: (888) 212-7538

USA Direct: 713-893-8956

Canada: 437-888-0177

UK: 203-769-2757

International Callers: +1-713-893-8956

Amcrest Cloud App



To download the Amcrest Cloud app for Android, visit amcrest.com/androidcloud



To download the Amcrest Cloud app for iOS, visit amcrest.com/ioscloud

Amcrest View Pro App



To download the Amcrest View Pro app for Android, visit amcrest.com/androidviewpro



To download the Amcrest View Pro app for iOS, visit amcrest.com/iosviewpro

Product Support

To download the User Manual for your camera, visit amcrest.com/support

To view our product support videos visit amcrest.com/videos

For view translated versions of this document visit amcrest.com/languages

Amcrest Cloud Features

To help guide you through the features of the Amcrest Cloud app, visit amcrest.com/cloud

Amcrest View Pro App Features

To help guide you through the features of the Amcrest View Pro App, please refer to the user manual or visit: amcrest.com/support

FCC COMPLIANCE STATEMENT

1. This device complies with Part 15 of the FCC Rules. Operation is subject to the following two conditions: (1) this device may not cause harmful interference, and (2) this device must accept any interference received, including interference that may cause undesired operation.

2. The users manual or instruction manual for an intentional or unintentional radiator shall caution the user that changes or modifications not expressly approved by the party responsible for compliance could void the user's authority to operate the equipment. In cases where the manual is provided only in a form other than paper, such as on a computer disk or over the Internet, the information required by this section may be included in the manual in that alternative form, provided the user can reasonably be expected to have the capability to access information in that form.

3. (b) For a Class B digital device or peripheral, the instructions furnished the user shall include the following or similar statement, placed in a prominent location in the text of the manual: NOTE: This equipment has been tested and found to comply with the limits for a Class B digital device, pursuant to Part 15 of the FCC Rules. These limits are designed to provide reasonable protection against harmful interference in a residential installation. This equipment generates, uses and can radiate radio frequency energy and, if not installed and used in accordance with the instructions, may cause harmful interference to radio communications. However, there is no guarantee that interference will not occur in a particular installation. If this equipment does cause harmful interference to radio or television reception, which can be determined by turning the equipment off and on, the user is encouraged to try to correct the interference by one or more of the following measures: Reorient or relocate the receiving antenna. Increase the separation between the equipment and receiver. Connect the equipment into an outlet on a circuit different from that to which the receiver is connected. Consult the dealer or an experienced radio/TV technician for help.

4. RF exposure warning this equipment must be installed and operated in accordance with provided instructions and the antenna(s) used for this transmitter must be installed to provide a separation distance of at least 20 cm from all persons and must not be co-located or operating in conjunction with any other antenna or transmitter. End-users and installers must be provided with antenna installation instructions and transmitter operating conditions for satisfying RF exposure compliance.