



iPad Pro 12.9-inch (5th generation) Wi-Fi

iPad Pro 12.9-inch (5th generation) Cellular mmW

iPad Pro 12.9-inch (5th generation) Cellular 5G

Apple Recycler Guide

July 2023

Contents

3	About This Guide
4	Identification
5	Directive 2012/19/EU Annex VII Components
6	Safety Considerations
9	Recommended Tools
10	Disassembly Instructions
30	Material Categorization of Output Fractions

About This Guide

Apple Recycler Guides provide guidance for electronics recyclers on how to disassemble products to maximize recovery of resources. The guides provide step-by-step disassembly instructions and information on the material composition to help recyclers direct fractions to the appropriate material recycler.

To conserve important resources, we work to reduce the materials we use and aim to one day source only recycled or renewable materials in our products. A key path to reaching that goal is resource recovery from end-of-life electronics.

Disassembly procedures are intended to be performed only by trained electronics recycling professionals. The recycler is responsible for independently evaluating and ensuring compliance with all applicable environmental, health, and safety laws related to the work. These include but are not limited to laws relating to the management, handling, shipping, and disposal of the outputs of this work as waste and laws in place to ensure the health and safety of all employees who support this work.

For questions or feedback about this guide, email contactesci@apple.com.

Note: This guide may show images from other similar models, but the procedures are the same.

Identification

You can find the model number on the back of the iPad Pro.

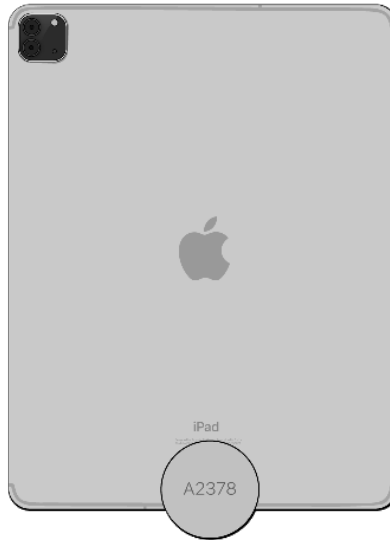

Model numbers:

Wi-Fi: A2378

Cellular: A2379, A2461, A2462

Directive 2012/19/EU Annex VII Components

Directive 2012/19/EU Annex VII requirements apply to the following substances and components.

Substance/Component	Apple Part Name	Removal Instructions
Printed circuit board if the surface is greater than 10 square centimeters	Main logic board, display logic board, power supply logic board	Follow steps 1–18
External electric cables	Power adapter	Follow step 1
Battery	Lithium-ion polymer batteries	Follow steps 1–6
Cover glass and liquid crystal display (LCD) cell if the surface is greater than 100 square centimeters	Display	Follow steps 1–5
No further substances or components as listed in Annex VII		

Safety Considerations

The recycler is responsible for independently evaluating all activities undertaken by its employees to perform or support the work and ensuring compliance with all applicable health and safety laws related to the work. These include but are not limited to laws relating to the health and safety of all employees who perform or support this work. The recycler is also responsible for evaluating the workspace and ensuring that the area in which the work is to be undertaken is designed using ergonomic best practices and meets all ergonomic requirements to ensure the protection of its employees.

Personal Protective Equipment

Personal protective equipment should be worn during the entire recycling process.



Wear eye protection



Wear foot protection



Wear hand protection



Wear a mask



Wear protective clothing

Battery Safety

This product uses a lithium-ion polymer battery. Before beginning any disassembly work, ensure that a safe working procedure for handling lithium-ion batteries has been established, which could include discharging the batteries so that they can be more safely managed. The following considerations may also be included:

- Remove anything from your person that could conduct energy, such as jewelry and watches, to avoid electric shock to yourself or the logic board.
- To avoid the potential for thermal runaway and the release of potentially noxious fumes, don't puncture, strike, or crush lithium-ion polymer batteries or devices powered by them.
- Don't throw, drop, or bend the battery.
- Don't expose the battery to excessive heat or sunlight.
- Don't use tools that are sharp or conduct electricity.
- Keep your workspace clear of foreign objects and sharp materials.
- Dispose of batteries according to local environmental laws and guidelines.

Workspace safety guidelines

- Use heat-resistant gloves and safety glasses.
- Keep a sand dispenser within arm's reach (2 feet or 0.6 m) on one side of the workstation, not above the workstation. The dispenser should be a wide-mouthed, quick-pour metal container with a flip-top lid or tray that contains 8–10 cups (1.9–2.4 L) of clean, dry, untreated sand.
- Keep the battery at least 2 feet (0.6 m) from paper and other combustible materials.
- Work in an area with adequate ventilation.

Handling a thermal runaway

If you notice any of the following signs, a thermal runaway is likely underway, and you should act immediately:

- The lithium-ion polymer battery or a device containing one begins to smoke or emit sparks or soot.
- The battery pouch suddenly and quickly puffs out.
- You hear hissing or popping sounds.

Don't use water or an ABC/CO₂ fire extinguisher on a thermal runaway battery or a device containing one. Water and ABC/CO₂ fire extinguishers will not stop the reaction.

Do smother the battery or device immediately with plenty of clean, dry sand, dumped all at once. Timing is critical; the faster you pour all the sand, the faster the thermal runaway will stop.

Do leave the room for 30 minutes if the thermal runaway causes any irritation.

Do wait 30 minutes before touching the battery. Wear heat-resistant gloves and safety glasses to remove the battery from the sand, or use a touchless thermometer to measure the battery temperature. Only touch the battery when the event has finished.

Do dispose of the damaged battery or device (including any debris removed from the sand) according to local environmental laws and guidelines.

LED Safety

Broken light-emitting diodes (LEDs) must be handled properly to ensure the safety of your employees and mitigate any hazards. Package broken LEDs in an appropriate container to properly manage the hazards associated with the materials and store only with compatible materials. All waste must be properly classified, packaged, and labeled in accordance with all relevant laws and regulations.

Hazard Warnings



Broken glass hazard



Chemical inhalation hazard



Chemical exposure hazard



Rechargeable battery hazard

Recommended Tools

Miniature pry bar

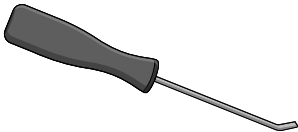

Nail-pulling screwdriver

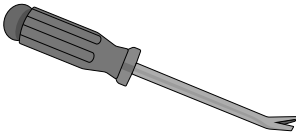

Plastic pry bar

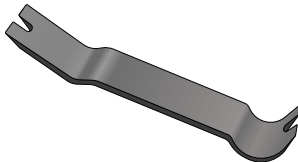

Screwdriver-handle pry bar

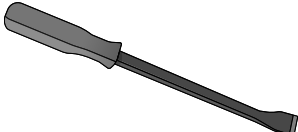

Disassembly Instructions

1. Remove the power adapter and the charge cable.

» *Ensure that the iPad is turned off.*



» *Unplug the power adapter. Disconnect both ends of the charge cable.*

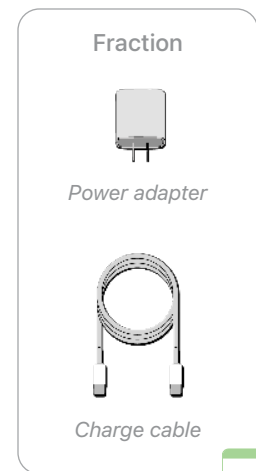

Fraction



Power adapter



Charge cable

Cu

Copper

2. Remove the display.



Broken glass hazard



Chemical exposure hazard

Tools Used



- » *Hold the iPad at the edge of a counter with the display facing up.*
- » *Insert the tool tip into the bottom of the display. Push the handle down to pry the display from the enclosure.*

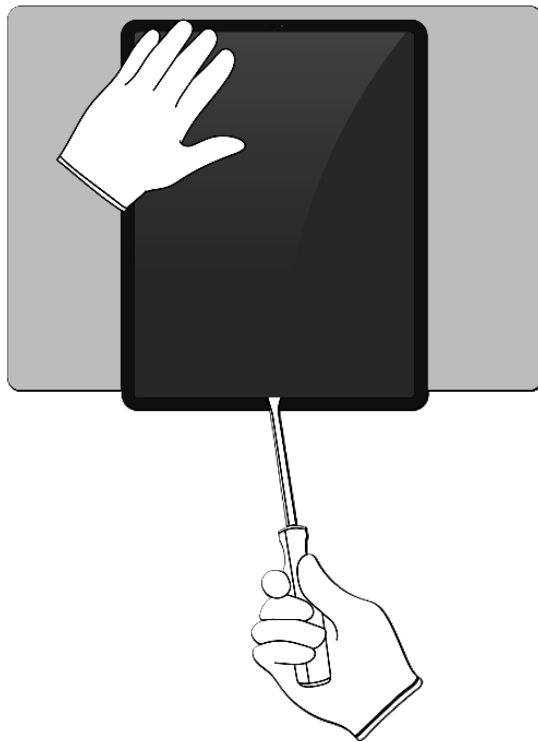

- » *Remove the display by hand. Set the enclosure aside.*

3. Remove the display logic board.

- » Lay the display facedown.
- » Pry off the display logic board.

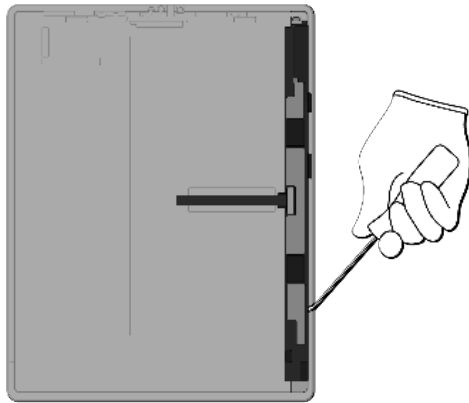

Tools Used



Fraction



Display logic board

PMs
Precious Metals

4. Pull off the light sensors.

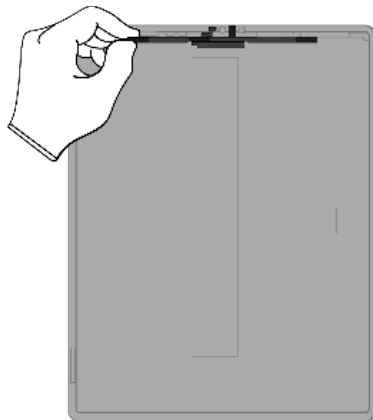

Fraction



Light sensors

Cu
Copper

5. Pry off the LED array.



Chemical inhalation hazard

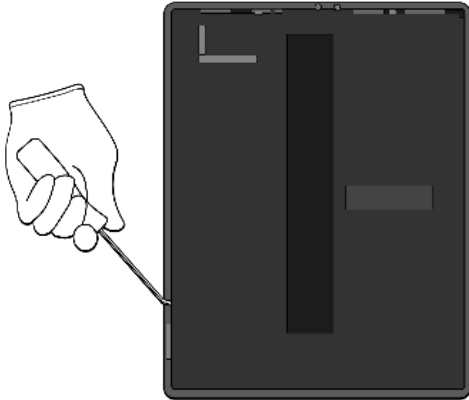

Tools Used



Fraction



LED array

PMs
Precious Metals

Fraction



LCD cell

GL
Glass

6. From the enclosure, carefully remove the four lithium-ion polymer batteries.

 Rechargeable battery hazard

- » *Using tweezers, gently peel one of the black battery adhesive tabs away from the battery.*
- » *Twist the tab around the tweezers until white adhesive appears. Continue twisting until the entire adhesive strip is removed.*
- » *Repeat this process for any remaining battery tabs. Continue with the plastic pry bar if needed.*

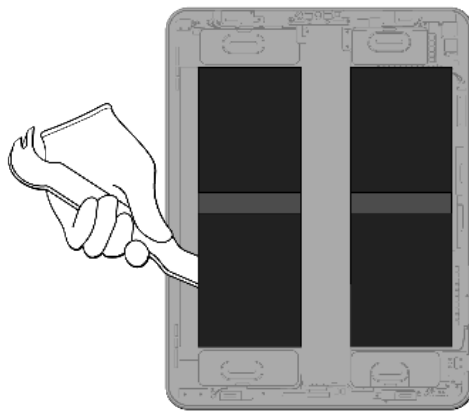

Tools Used

A grey plastic pry bar with a curved end and a small notch.

Fraction

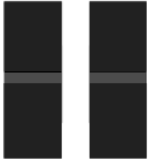
Two black rectangular lithium-ion polymer batteries, each with a white horizontal strip across the middle.

Lithium-ion polymer batteries



7. Pry off the rear camera cover.

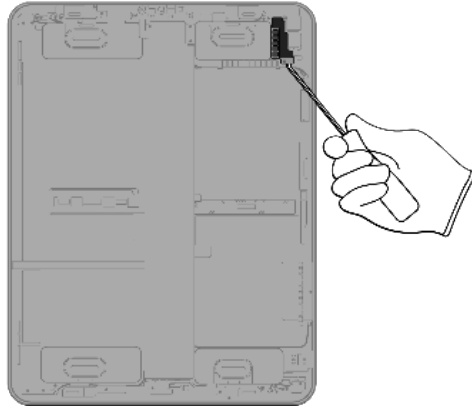

Tools Used



Fraction



Rear camera cover

Fe

Ferrous

8. Pry off the lower rear camera.

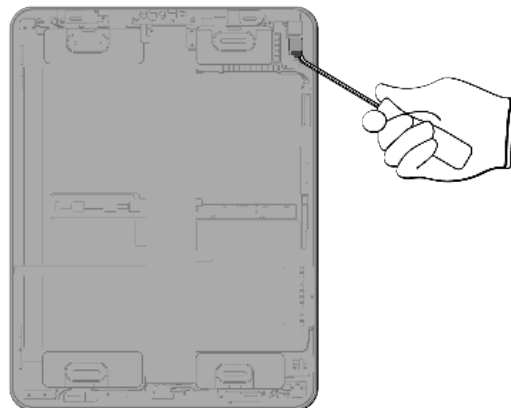

Tools Used



Fraction



Lower rear camera

PMs

Precious Metals

9. Pry off the upper rear camera.

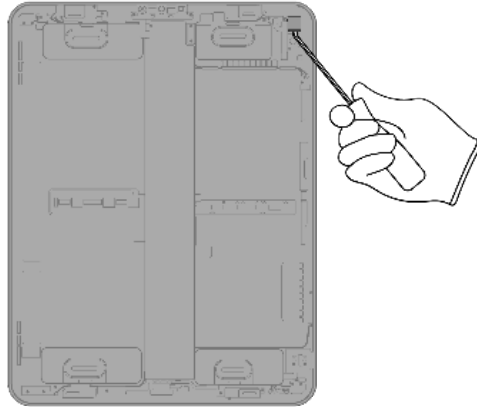

Tools Used



Fraction



Upper rear camera

PMs
Precious Metals

10. Pry off the strobe.

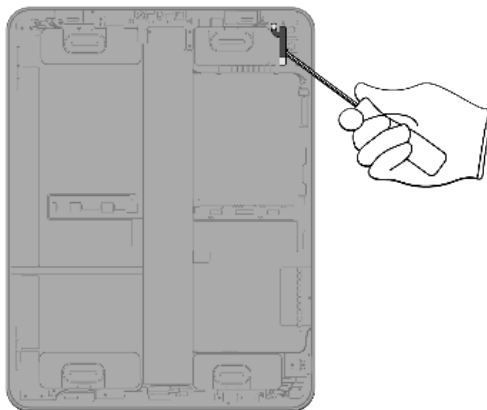

Tools Used



Fraction



Strobe

Cu
Copper

11. Pry off the LiDAR Scanner.

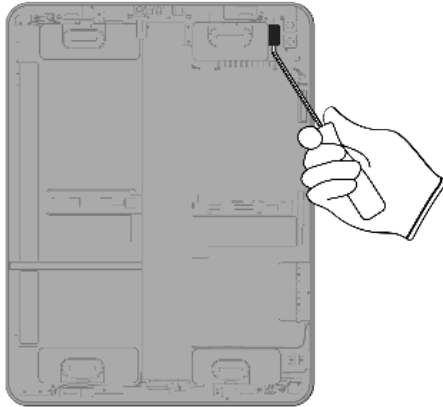

Tools Used



Fraction



LiDAR Scanner

PMs
Precious
Metals

12. Pry off the upper right tweeter.

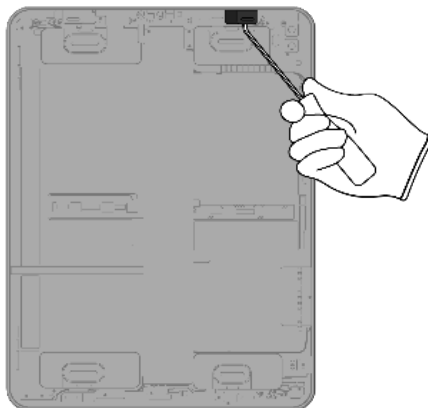

Tools Used



Fraction



Upper right tweeter

REE
Rare Earth
Elements

13. Pry off the front camera.

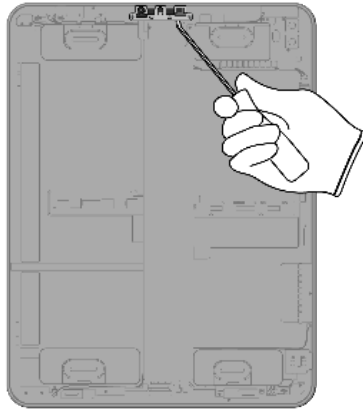

Tools Used



Fraction



Front camera

PMs
Precious Metals

14. Pry off the upper left tweeter.

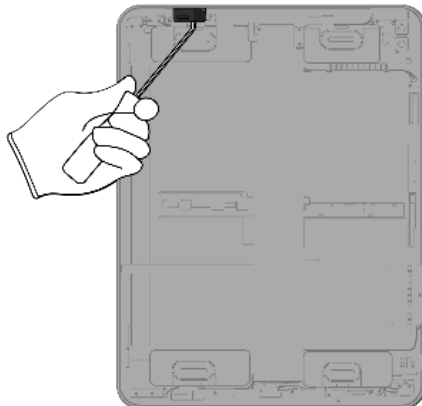

Tools Used



Fraction



Upper left tweeter

REE
Rare Earth Elements

15. Pry off the upper left woofer.

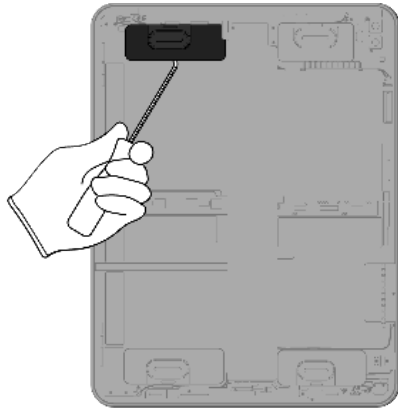

Tools Used



Fraction



Upper left woofer

REE
Rare Earth
Elements

16. Pry off the main logic board.

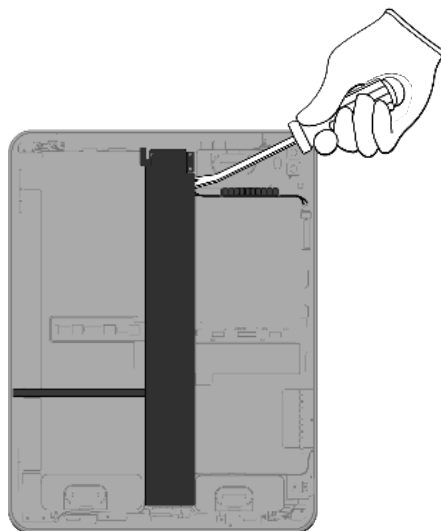

Tools Used

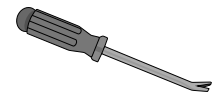

Fraction



Main logic board

PMs
Precious
Metals

17. Pry off the upper right woofer.

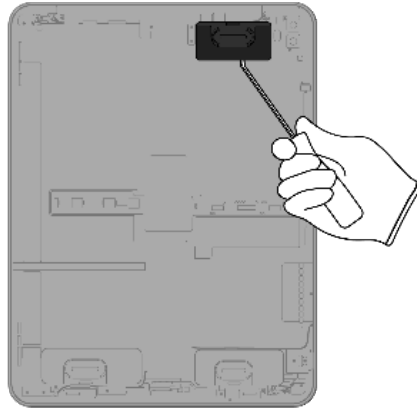

Tools Used



Fraction



Upper right woofer

REE
Rare Earth
Elements

18. Pry off the power supply logic board.

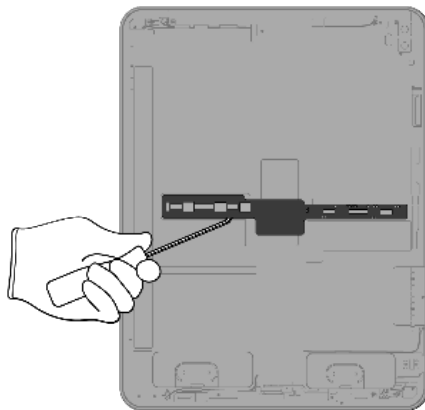

Tools Used



Fraction



*Power supply
logic board*

PMs
Precious
Metals

19. Pry off the antenna.

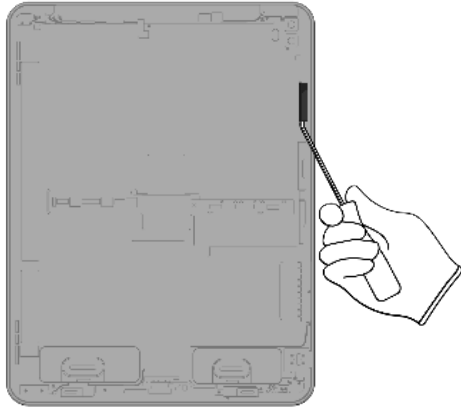

Tools Used



Fraction



Antenna

Cu

Copper

20. Pry off the Apple Pencil magnetic connector.

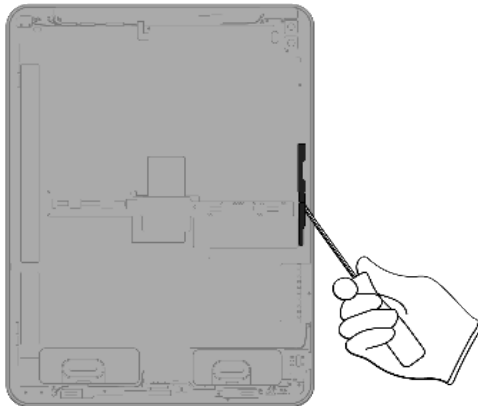

Tools Used



Fraction



Apple Pencil
magnetic connector

Cu

Copper

21. Pry off the side ribbon cable.

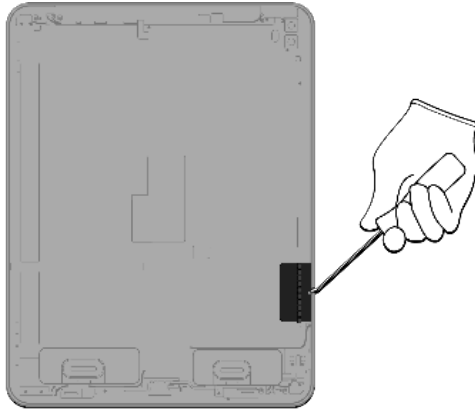

Tools Used



Fraction



Ribbon cable

Cu

Copper

22. (Cellular models only) Remove the SIM tray. Separate the SIM card from the SIM tray.

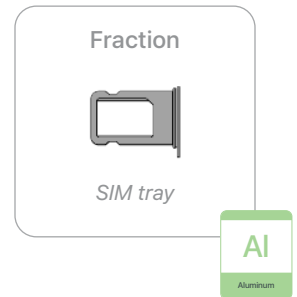
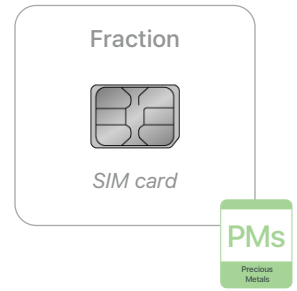
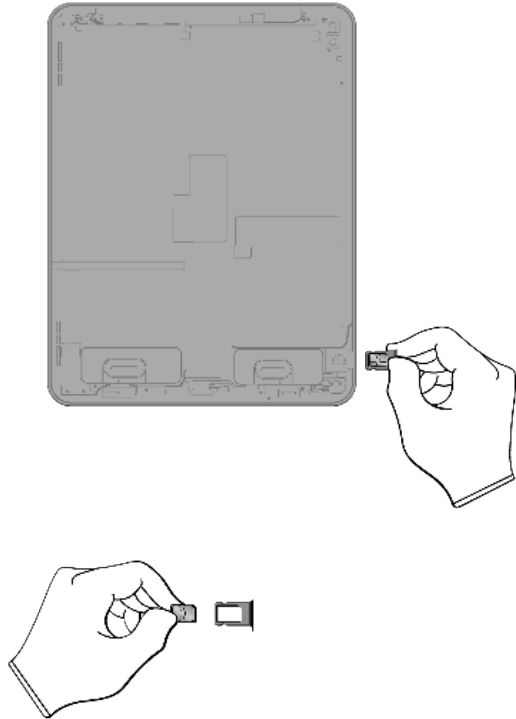

23. (Cellular models only) Pry off the SIM reader.

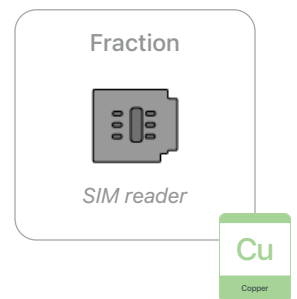
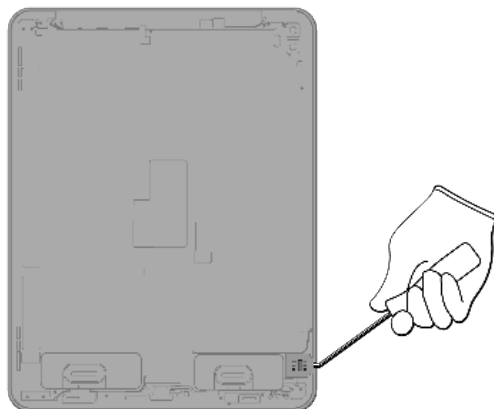

24. Pry off the lower right woofer.

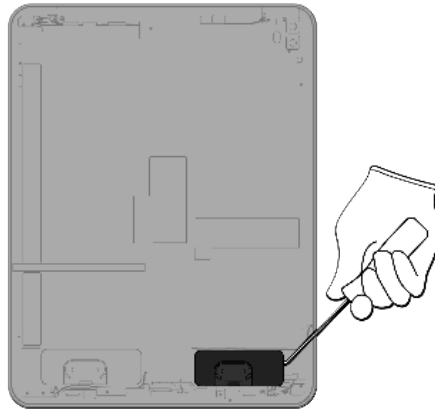

Tools Used



Fraction



Lower right woofer



25. Pry off the lower left woofer.

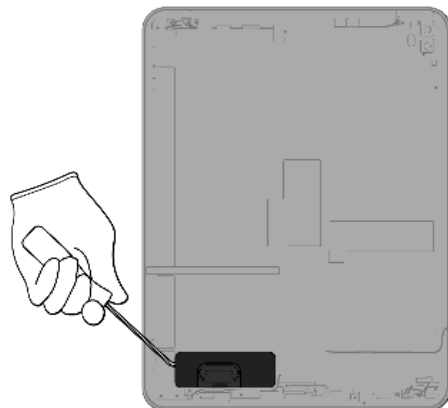

Tools Used



Fraction



Lower left woofer



26. Pry off the Smart Connector.

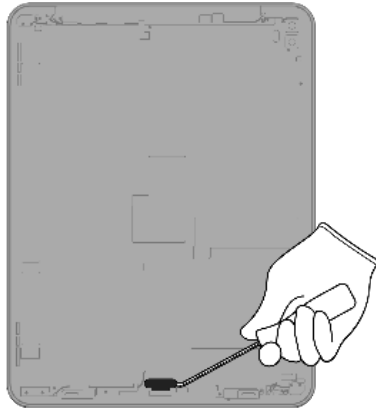

Tools Used



Fraction

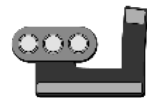

Smart Connector

Cu

Copper

27. Pry off the USB-C port.

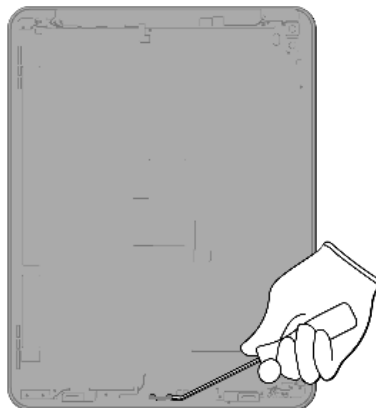

Tools Used



Fraction

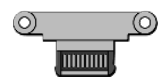

USB-C port

Cu

Copper

28. Pry off the lower right tweeter.

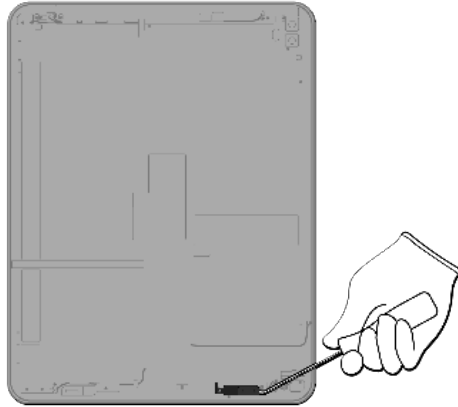

Tools Used



Fraction



Lower right tweeter

REE

Rare Earth
Elements

29. Pry off the lower left tweeter.

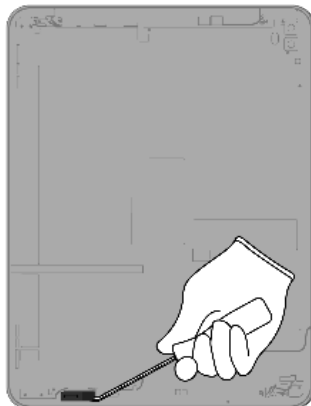

Tools Used



Fraction



Lower left tweeter

REE

Rare Earth
Elements

30. Pry off the Apple Pencil charging coil.

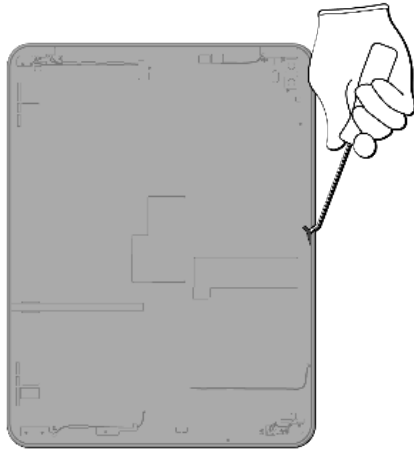

Tools Used



Fraction



*Apple Pencil
charging coil*

Cu

Copper

31. Pull off the remaining ribbon cables and wires.

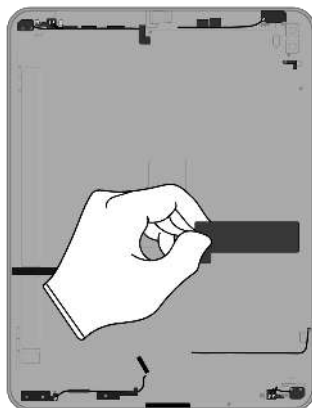

Fraction



*Ribbon cables
and wires*

Cu

Copper

32. Pry off the microphones.

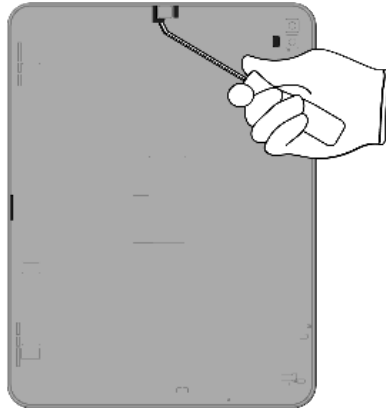

Tools Used



Fraction



Microphones

Cu

Copper

33. Pry the 127 magnets off the enclosure.

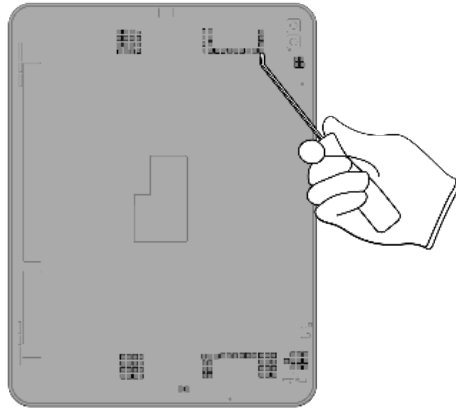

Tools Used



Fraction



Magnets (x127)

REE
Rare Earth
Elements

Fraction







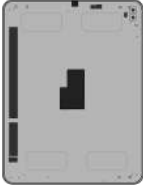

Enclosure

Al
Aluminum

Material Categorization of Output Fractions

All outputs from this process must be managed, handled, and disposed of in accordance with applicable waste laws and regulations, including but not limited to the Waste Framework Directive and its national enactments in Europe.

Fraction	Downstream Processing
<p>Aluminum</p>  <p><i>SIM tray</i></p>  <p><i>Enclosure</i></p>	<p>Primary Target Material</p>  <p>Potential Additional Materials</p>  

<p>Batteries</p>  <p><i>Lithium-ion polymer batteries</i></p>	<p>Primary Target Material</p> 
---	---

Fraction

Downstream Processing

Ferrous



Rear camera cover

Primary Target Material



Potential Additional Materials



Glass



LCD cell

Primary Target Material



Potential Additional Materials



Fraction

Downstream Processing

Logic Boards



Display logic board



LED array



Lower rear camera



Upper rear camera



LiDAR Scanner



Front camera

Primary Target Material



Potential Additional Materials



Logic Boards (cont.)



Main logic board



Power supply logic board



SIM card

Fraction

Downstream Processing

Mixed Electronics



Power adapter



Charge cable



Light sensors



Strobe



Antenna



Apple Pencil magnetic connector

Primary Target Material



Potential Additional Materials



Mixed Electronics (cont.)



Ribbon cables and wires



SIM reader

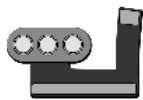

Smart Connector

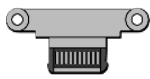

USB-C port



Apple Pencil charging coil

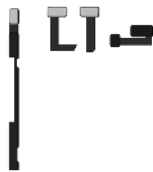

Microphones

Fraction

Downstream Processing

Rare Earth Magnets



Upper right tweeter



Upper left tweeter



Upper left woofer



Upper right woofer



Lower right woofer



Lower left woofer



Lower right tweeter



Lower left tweeter



Magnets (x127)

Primary Target Material



Potential Additional Materials

