

Artemide®

STELLAR NEBULA

design
BIG

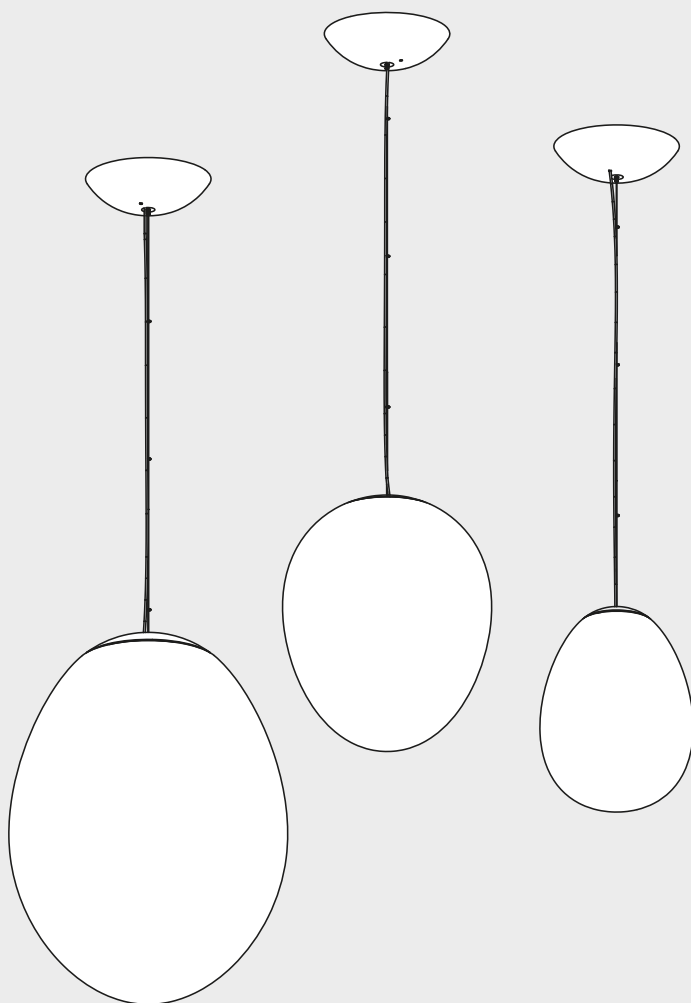



i

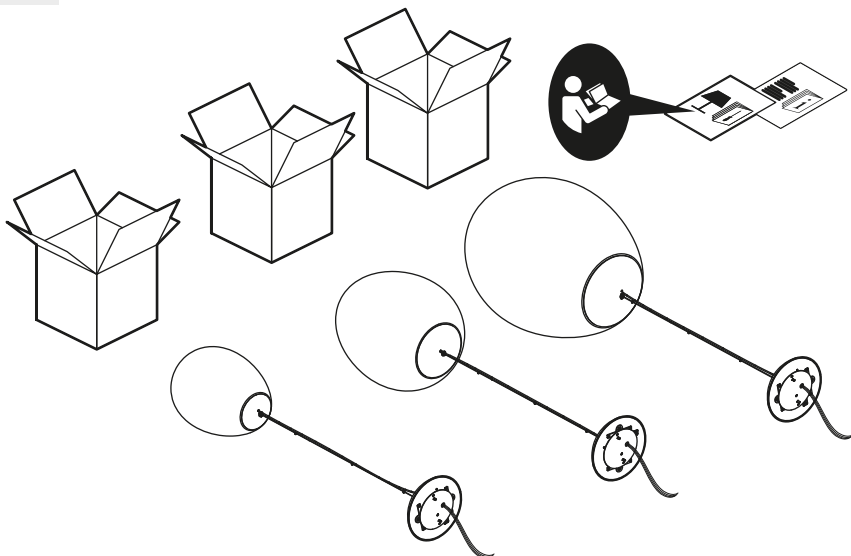

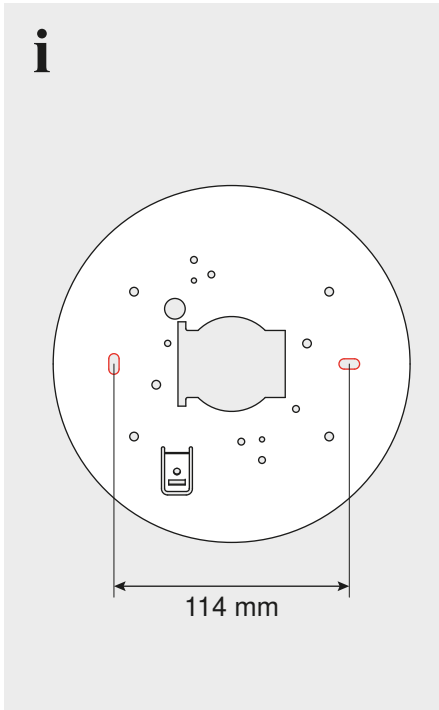
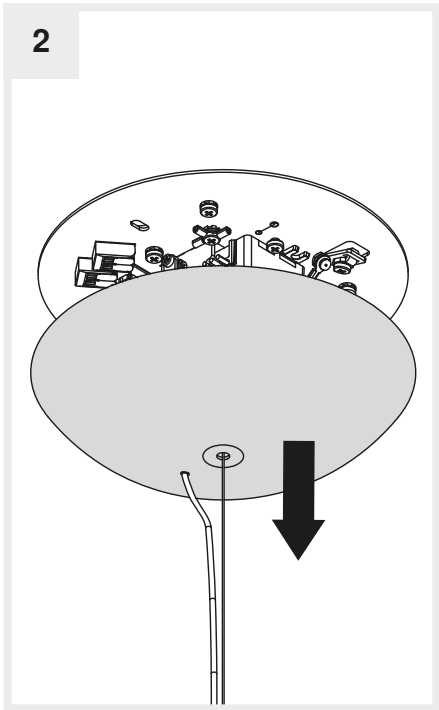
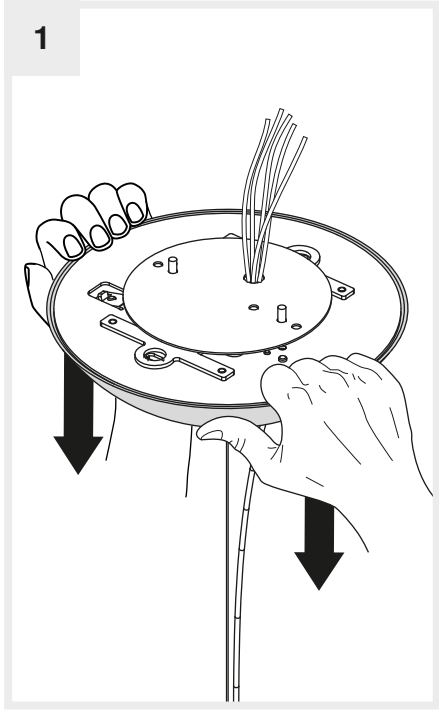
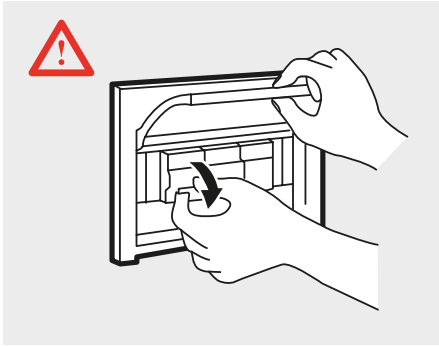

3a

	120 V	Phase cut Coupure de phase Corte de fase
---	-------	--

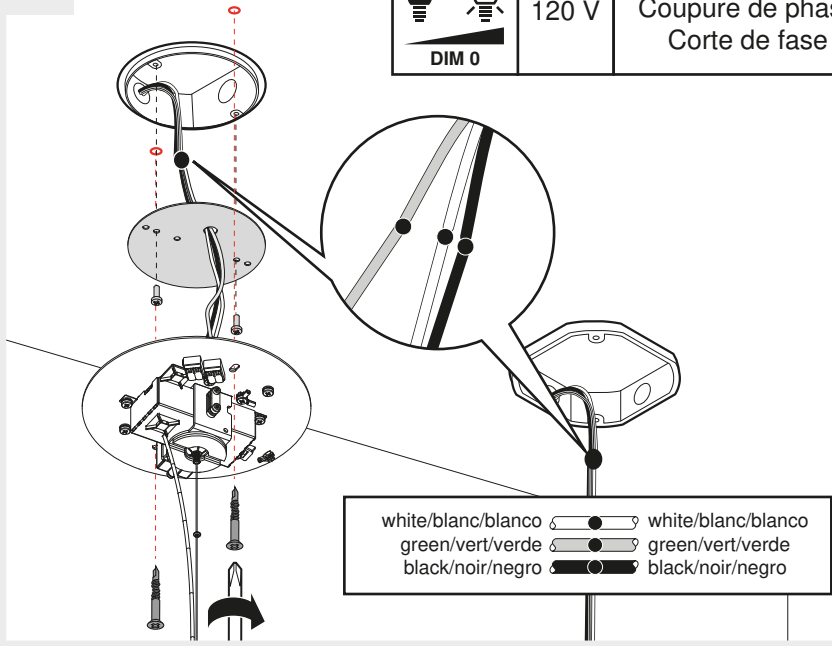

3b

	120-277 V	0-10 V dimming control Dimmable 0-10 V Regulable mediante control 0-10 V
---	-----------	--

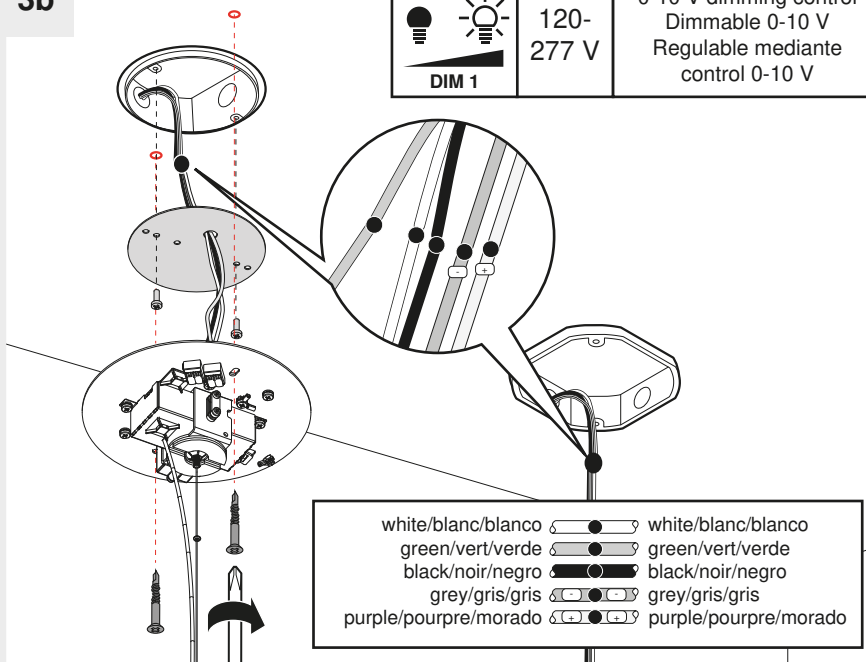

4

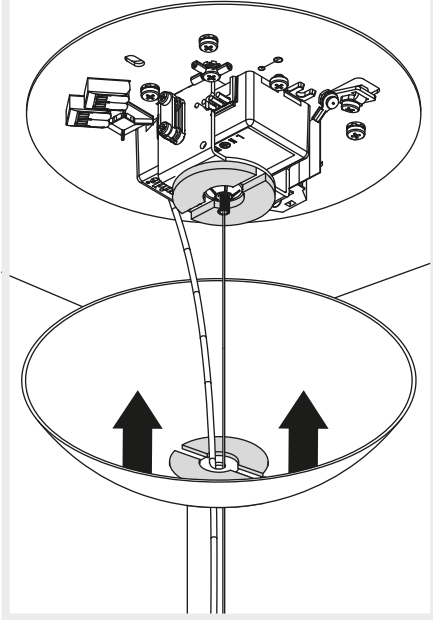

5

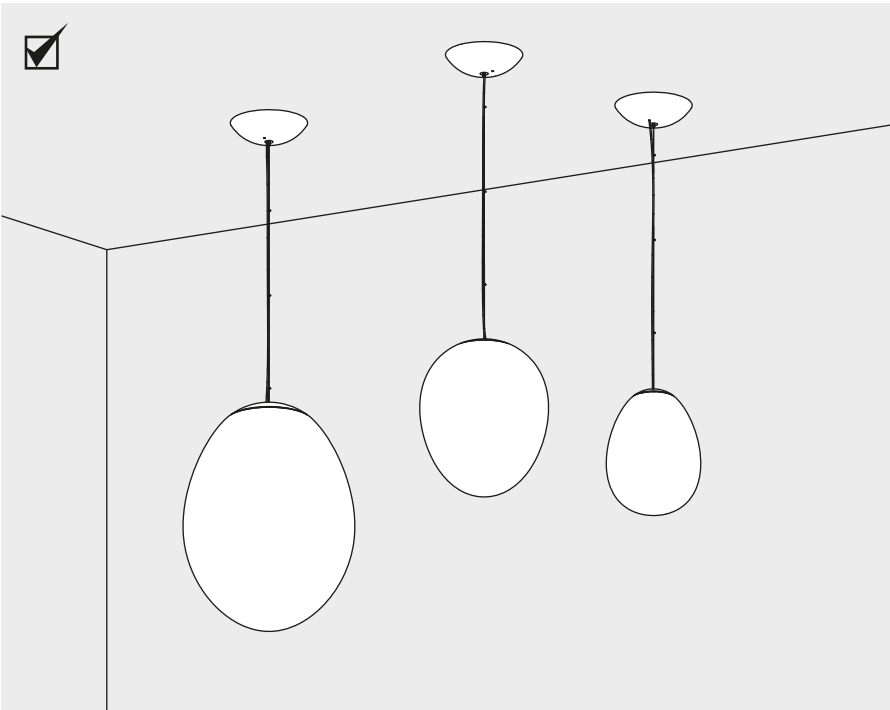
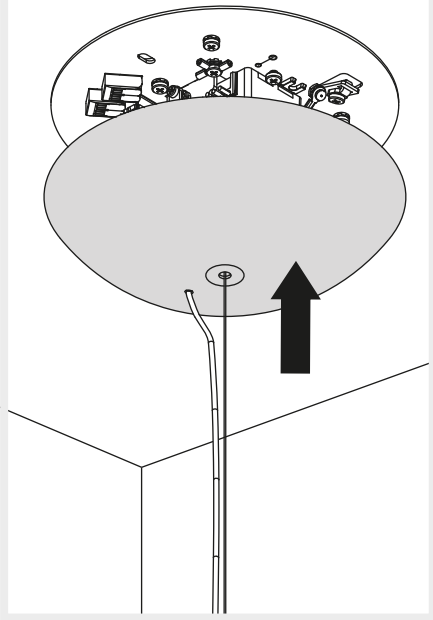

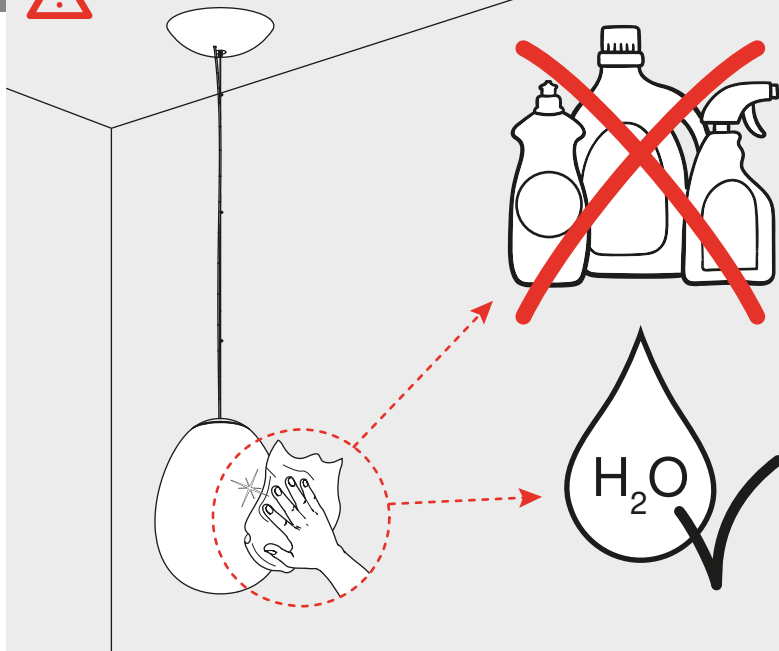

Artemide®

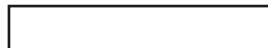

Artemide

via Bergamo, 18
20006 Pregnana M.se (MI)
ITALIA

tel. +39 02 935 181
fax +39 02 935 90 254
fax +39 02 935 90 496

www.artemide.com

VAT IT00846890150

Artemide Inc.

250 Karin Lane
Hicksville, NY 11801

tel. 631 694 9292
Toll Free 1-877-Art-9111
Fax 631 694 9275

www.artemide.net

Artemide Ltée/Ltd.

11105 rue Renaude Lapointe
Montréal, Québec H1J 2T4

Tel. 514 323 6537
Toll Free 888 777 2783
Fax 514 323 8864

www.artemide.net

cod. Y513001634A