

Astromi

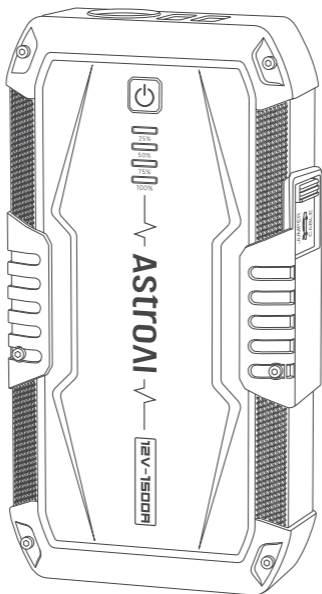

S8

MULTIFUNCTIONAL JUMP STARTER

USER MANUAL

INTRODUCTION

Thank you for purchasing the AstroAI Multifunctional Jump Starter.

This jump starter uses the ultra-powerful discharge technology of a lithium battery to help users jumpstart car batteries that are fully depleted or in a low-temperature environment. It also functions as a power bank and emergency flashlight; it is a must-have tool for the outdoors.

We hope this jump starter protects you on your journeys. AstroAI strives to build tools that help you enjoy all of life's adventures.

Questions or concerns? You are welcome to contact us via support@astroai.com.



Please fully read and follow this manual before using this product and keep this manual for future reference.

WARNING

- This jump starter is not a toy. Incorrect usage may cause injuries and accidents.
- This jump starter cannot be used as a car battery.
- Do not press the Boost Button before connecting to the car battery.
- Do not connect the red clamp to the black clamp.
- Keep out of the reach of children.
- Do not use the car jump starter to start your car while the jump starter is charging.
- Please do not soak the jump starter in water or expose it to rain.
- Do not modify or disassemble the jump starter. Jump starter repair work should only be performed by professional technicians.
- Do not operate the jump starter in a dangerous environment or around flammable liquid, gas or dust.
- Only use this product with the included smart battery clamps. Do not use the jumper clamps if they are damaged or if the cables are damaged.
- Compatible with 12 V vehicles only. Inappropriate usage may cause accidents or injuries. (Please do not use this product on non-12 V vehicles, such as airplanes and other 24 V vehicles/boats.)
- Ensure the battery terminals are clean and the jumper clamps are undamaged before starting your car. A dirty connection may reduce performance.
- Ensure the blue plug on the smart battery clamps is fully inserted into the socket, or it may burn.

- Ensure the jump starter's battery level exceeds 75% before starting your car.
- Take off any metal accessories, such as rings, bracelets or necklaces, before you operate the jump starter.
- Do not continuously jumpstart your car; doing so may cause the jump starter to overheat and sustain damage. (Allow a 30-second interval between jump starts to avoid overheating the jump starter.)
- Remove the jump starter from the vehicle's battery within 30 seconds of jumpstarting your car. Failure to do so may cause damage.
- Do not drop/toss the jump starter. If the jump starter is hit or damaged, a qualified battery technician will need to test it.
- Do not store the jump starter at temperatures above 70 °C/158 °F.
- You may dispose of the lithium battery according to local guidelines when its service life has ended.

PACKAGE INCLUDES

Multifunctional Jump Starter	× 1
Smart Battery Clamps	× 1
USB-A to USB-C Charging Cable	× 1
Storage Bag	× 1
User Manual	× 1

DIAGRAM

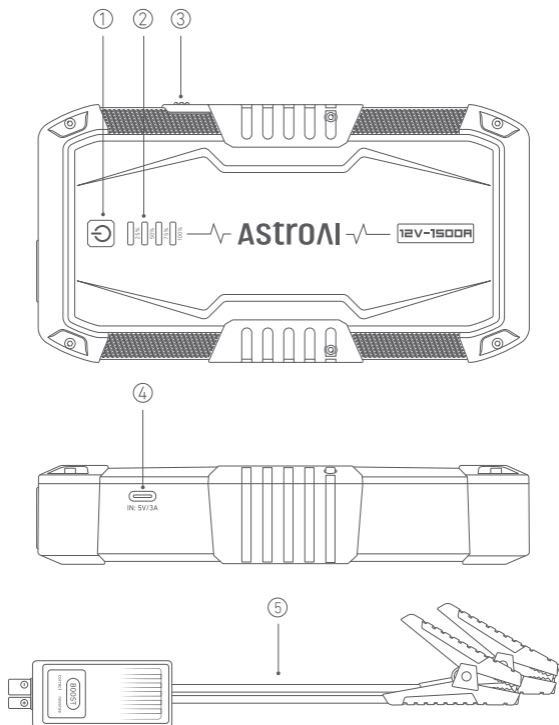

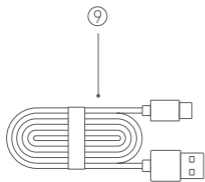
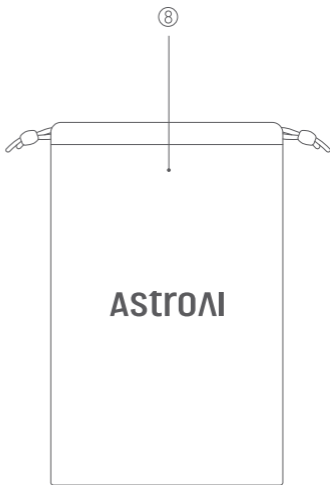
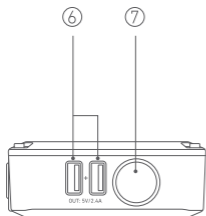

- ① Power Button
- ② Battery Level Indicator
- ③ 12 V Jumpstart Port
- ④ Quick-Charge Input Port
- ⑤ Smart Battery Clamps
- ⑥ 5 V \equiv 2.4 A Output Port
- ⑦ LED Flashlight (Emergency Light)
- ⑧ Storage Bag
- ⑨ USB-A to USB-C Charging Cable

PREPARATION

Fully charge the jump starter after receiving it.

I. Checking the battery level

Press the Power Button to check the battery level, then the battery indicators will illuminate:

Indicator	Battery level
1 bar	Under 25%
2 bars	Between 25% and 50%
3 bars	Between 50% and 75%
4 bars	Between 75% and 100%

II. Charging the device

To charge the jump starter, connect the included charging cable's USB-C end into the device's charging port and the cable's USB-A end to the power source. The power source can be any USB source like 5 V wall chargers, car chargers, etc. (**Note:** charging block not included.)

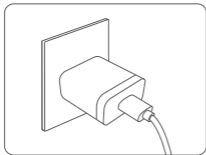
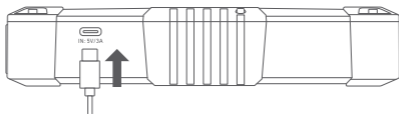

or

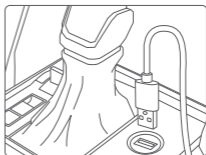

Note: The battery indicators will illuminate circularly while charging; the illuminated indicators represent the current battery level. If all four of the battery indicators are off, it means the charging is complete.

INSTRUCTIONS

Jumpstarting Function

1. Fully insert the smart battery clamps into the jump starter.
Connect the red clamp to the battery's positive terminal (+) and the black clamp to the battery's negative terminal (-).

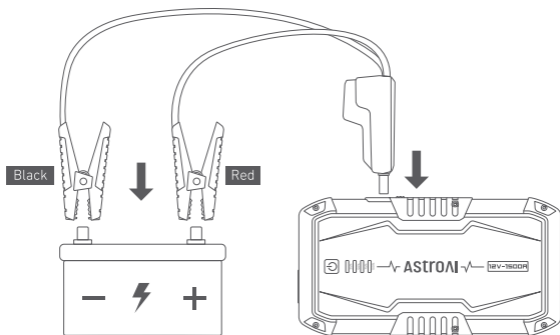

2. Operate the jump starter according to the indicator on the smart battery clamps.

Illuminated green indicator:

Correct connection, it is safe to operate. Move to step 3.

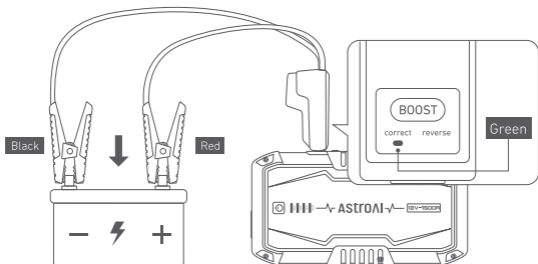

Illuminated red indicator:

Reversed connection, please reconnect the positive and negative terminals correctly. Continue to step 3 after the indicator turns green.

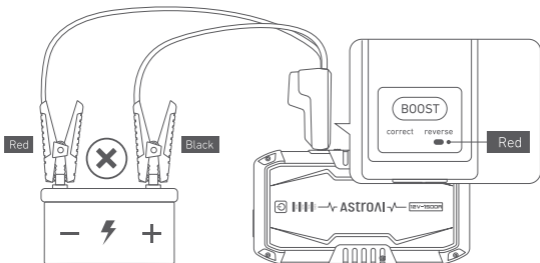

The indicator flashes green:

Low battery voltage. Please press the Boost Button and wait until the indicator turns green. Then, complete step 3 within 30s.

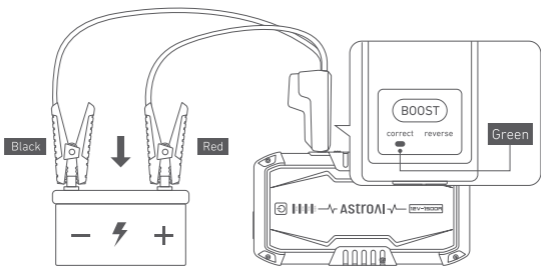

3. When the smart battery clamps' indicator is illuminated green, jumpstart your car.

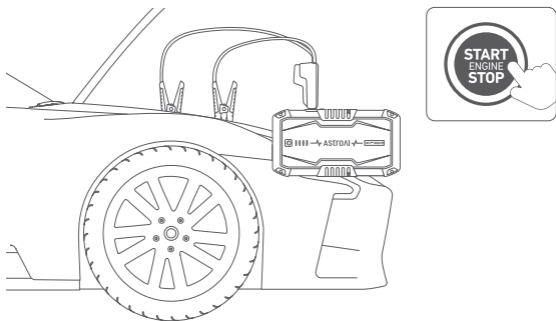

4. After successfully jump starting the car, disconnect the smart battery clamps.

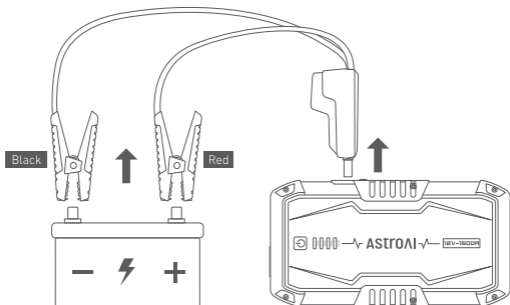

Tip 1:

Turn off any electrical devices in the vehicle before jump starting it.

Tip 2:

If the vehicle does not start within 5 seconds of attempting ignition, stop and remove the clamps. Wait for 60 seconds and retry step 3.

Tip 3:

If the indicator on the smart battery clamps does not light up at all: The battery may be damaged. You may retry step 2.3 when the battery clamps are correctly attached, or contact AstroAI.

Power Bank Function

1. Insert the USB plug into the 5 V==2.4 A output port.

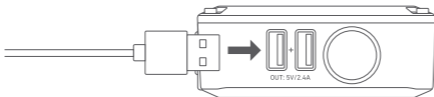

2. Connect the other end of the USB Charging cable to the device being charged.
3. Press the Power Button to charge the devices. The jump starter will automatically detect the devices' specifications and charge them at the proper voltage.

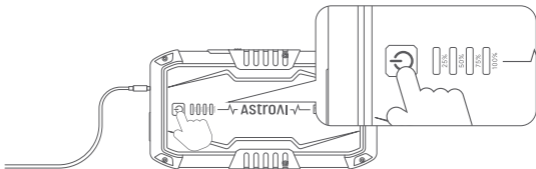

Illumination Function

Press and hold the Power Button for 3 seconds to turn on the illumination function.

Press the button again to choose between Flashlight mode, Strobe mode, SOS mode and OFF.

MAINTENANCE

- To maximize the battery's performance and service life, please charge the jump starter when its battery level is lower than 75%.
- Please fully charge the jump starter if it is about to be idle for a long time. And charge it every three months to extend its service life.

SPECIFICATIONS

Model	S8
Capacity	37 Wh
Jumpstart Current	300 A
Peak Current	1500 A
USB Output	USB1 + USB2 5 V \equiv 2.4 A
USB Input	Quick Charge (5 V \equiv 3 A)
Operation Temperature	-4 °F~122 °F; -20 °C~50 °C
Charge Temperature	14 °F~113 °F; -10 °C~45 °C
Time to Fully Charge	Approximately 3 hours for 10 W

- This jump starter features four built-in 3.7 V lithium batteries in a series connection.
- The battery pack capacity is 2500 mAh (14.8 V), equivalent to 10000 mAh (3.7 V).

TROUBLESHOOTING/FAQ

Q: If you fail to jumpstart the vehicle, please check the possible causes in order.

- Insufficient power level; you may need to charge the jump starter more. Please keep the battery level higher than 75% to ensure a successful jumpstart.
- Bad connection caused by rust or dirt on battery terminals; please clean the terminals and try again.
- The jump starter activated its overheating protection due to the battery overheating; please try again after it cools down.
- The battery clamps are connected to the incorrect terminals; please ensure the clamps are connected to the correct terminals.
- Poor connection between the smart jump starter clamps and battery; ensure the connection between the clamps and the battery is secure.
- The vehicle cannot start because of issues unrelated to battery power levels. Please use the appropriate equipment to check the battery or error code of the vehicle.
- Contact AstroAI for after-sales support.

Q: Failure to power on

- Insufficient power level or the jump starter is charging.
- Contact AstroAI for after-sales support.

Q: Failure to charge

- Check if the charging cable is connected correctly.
- Ensure the outlet is powered.
- The jump starter activated its overheating protection due to the battery overheating; please charge it after allowing it to cool down to room temperature.
- Contact AstroAI for after-sales support.

RECYCLING

You may dispose of the jump starter when its service life has ended, please recycle the recyclable parts according to local guidelines.

WARRANTY PERIOD

2-Year Limited Warranty from AstroAI

Each AstroAI Multifunctional Jump Starter will be free from defects in material and craft.

This warranty does not cover damage from neglect, misuse, contamination, alteration, accident, or abnormal conditions of operation or handling.

This warranty covers the original purchaser only and is not transferable.

AstroAI

Web: www.astroai.com

E-Mail: support@astroai.com