

# AudioControl®

Making Good Sound Great™

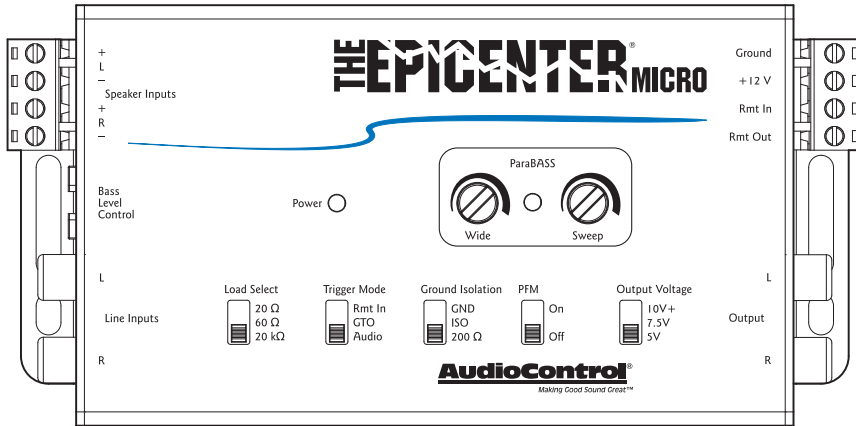

## Features

- Bass Maximizer circuitry
- Dual Knob Dash Mount Control
- ParaBASS®
- LMC™ Load Selection Input Stage
- Balanced Line Level Inputs
- PFM Subsonic Filter
- Speaker-Level Inputs for OEM integration
- Winter Fresh
- GTO™ Signal Sensing
- Compact Design

# THE EPICENTER MICRO

FOR COLOSSAL BASS ENHANCEMENT ONLY

Quick Start Guide

## Congratulations!

You now possess the most advanced version of the legendary bass restoration and enhancement processor. The Epicenter, with over 1 million sold, is the veritable master of bass enhancement processing. Silky smooth bass lines will leap out of your speakers and that kick drum, whether it be the equally legendary 808 or the deep punch that can only come from a 28" kick, The Epicenter Micro will make every low frequency better.

The Epicenter Micro keeps everything you have come to know and love about AudioControl's bass processing and added the OEM integration capabilities that AudioControl leads the world in. Speaker level input stage and the traditional line level inputs make The Epicenter Micro the go-to product for any application. Regardless of your age or music preference, the addition of an enhanced bass response to your mobile audio sound system makes for a truly amazing experience.

Being that we all vary in our bass response tastes, we've added even greater control over the bass response with the new ACR-4. The Epicenter effect as well as overall volume control are now part of the dual control ACR-4 controller knob. You can toss out that sub amp volume controller and install just the ACR-4 knob and have both styles of control at your fingertips!

Supreme ease of control, seamless OEM integration and installation with world renown bass restoration, it's pretty easy to just get going on the install straight away. Before you start taking apart the car to install this spectacular processor, please take a moment, grab a Georgetown Brewing Co., Johnny Utah Pale Ale and read through the details of this manual. The feature list is long so to take full advantage of everything we've packed into this baby, give this manual a decent read.

### Features of the Epicenter Micro

- Bass Maximizer circuitry
- Dash mount control
- Wide and Sweep parametric bass control
- LMC™ speaker level adaptive load input stage
- Multiple turn on options
- ACR-4™ dual controller
- Bass Maximizer effect control
- Overall Sub level control
- PFM Subsonic Filter bypass option

*All that means – the best bass enhancement and OEM integration device known to humanity!*

# Important Safety Instructions

1. Read these instructions.
2. Keep these instructions.
3. Heed all warnings.
4. Follow all instructions.
5. Do not use this apparatus under water.
6. Clean only with a dry cloth.
7. Do not block any ventilation openings. Install in accordance with the manufacturer's instructions.
8. Do not install near any heat sources such as mufflers, silencers, exhaust pipes, or other apparatus (including amplifiers) that produce heat.
9. **WARNING:** Improper installation may lead to permanent injury or death. Installation of the apparatus must be done with great care by qualified personnel, to prevent damage to fuel lines, power, and other electrical wiring, hydraulic brake lines, and other systems, that might compromise vehicle safety.
10. Provide +12V and Ground insulated wiring of 14 to 18 AWG to ensure adequate current to the amplifier.
11. Use rubber grommets to protect wiring whenever passing wires through metal openings or bulkheads.
12. Only use attachments/accessories specified by the manufacturer.
13. Refer all servicing to qualified service personnel. Servicing is required when the apparatus has been damaged in any way, such as the power input terminals are damaged, liquid has been spilled or objects have fallen into the apparatus, the apparatus has been exposed to rain or moisture, does not operate normally, or has been dropped.

14. Fuses shall be replaced only with the correct type and fuse value, and only when the apparatus is powered off.
15. Exposure to high sound pressure levels may lead to permanent hearing loss. Take every precaution to protect your hearing.



The lightning flash with arrowhead symbol within an equilateral triangle is intended to alert the user to the presence of uninsulated "dangerous voltage" within the product's enclosure, that may be of sufficient magnitude to constitute a risk of electric shock to persons.



The exclamation point within an equilateral triangle is intended to alert the user of the presence of important operating and maintenance (servicing) instructions in the literature accompanying the appliance.

Caution: to reduce the risk of electric shock, do not disassemble the apparatus, other than to remove the top panel to access the balancing adjustments on the PCB. There are no user-serviceable parts inside. Refer servicing to qualified personnel.



Recycling notice: If the time comes and this apparatus has fulfilled its destiny, do not throw it out into the trash. It has to be carefully recycled for the good of mankind, by a facility specially equipped for the safe recycling of electronic apparatus. Please contact your local or state recycling leaders for assistance in locating a suitable nearby recycling facility. Or, contact us and we might be able to repair it for you.

**AudioControl®**

Making Good Sound Great™

## Features

**Bass Maximizer** – The Epicenter Micro contains a bass maximization circuit that accurately recreates and injects low frequency information back into the signal path. What that means in everyday terms is that The Epicenter Micro will give more bass impact to your best 8-tracks and streaming services. US Patent #4,698,842

**ParaBASS<sup>®</sup>** – What’s the use of having good bass if you can’t control it? The Epicenter Micro has a unique equalization circuit that contours the restored bass to your speaker system.

**ACR-4 Dual Dash Mount Control** – The Epicenter Micro is designed to be mounted anywhere in the vehicle, with the exception of the front bumper or radiator. The new ACR-4 and a healthy run of cable is included for remote level control. This fine streamlined ACR-4 dual controller offers control over the Bass Maximizer effect (outer knob) and the overall sub level or volume (inner knob). Every tune’s mix is a little different and this controller dials your sub’s performance like nothing else on the planet. Sublime accuracy for your heightened enjoyment!

**PFM Subsonic Filter** – This unique feature is legendary with many AudioControl fanatics for its ability to fine tune the bass response of any system. With The Epicenter Micro, we’ve adjusted the performance down to 20 Hz and have added the Bypass switch on the top cover for those of you who want to hit some rich unknown low tones. Best be careful with that Bypass switch though; engage at the risk to your precious subs. Running full tilt on this baby can easily launch your sub right out of the basket, so the word here is “careful please”.

**Bass Output Control** – The Epicenter circuitry has the ability to produce large amounts of deep, mind shattering bass without damaging your speakers. The Bass Output Control circuit manages the voltage generated by The Epicenter Micro to maximize the bass output of any autosound audio system while restraining destructive bursts.

# Quick Start

The AudioControl Epicenter Micro was designed to produce bass like you have never heard before. With that said it is important to take the following precautions during its use.

1. If you have an equalizer in your system, turn down the bass frequencies to zero boost.
2. You will want to reduce any other bass tone control, loudness control, or other secondary bass controls prior to turning on The Epicenter Micro. Once your system is up and running, you may want to use those secondary controls to dial the bass in a bit more but we doubt it!
3. Good bass response requires an appropriate choice of speakers and amplification. Since the bass frequencies always require more power and cone area than higher frequencies... BE PREPARED. Small speakers and lack of power will be detrimental to your system.

The Epicenter Micro needs to be installed in the signal path between a source and an external amplifier(s). Although it can be installed after an equalizer, it was designed to be installed before a crossover and other signal processors for optimal performance.

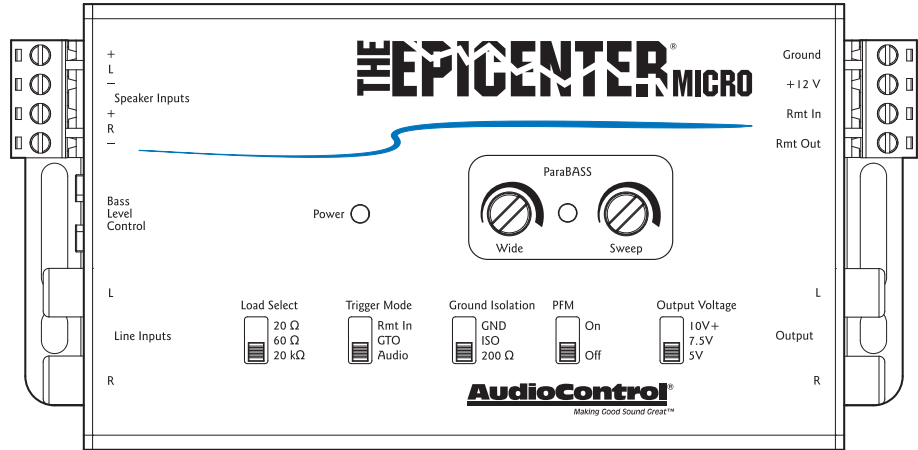

Once this is done, you just need to hook up power, ground, trigger, run the wire to the dash remote and tada!!! Instant bass. If you need to know more, then read on. Even if you don't think you need to know more, you should still read on, because you can never know too much.

## The Guided Tour

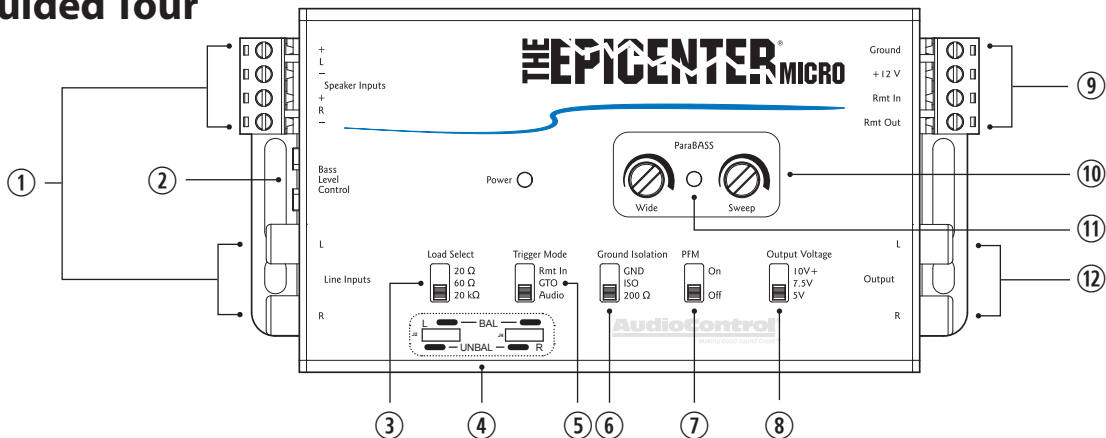

- 1. Inputs** – The input stage of The Epicenter Micro gives you options! If you have line level inputs, then just hook up those RCAs and you're all set. If you're integrating into a factory system, you have the speaker level inputs available as well.
- 2. Bass Level Control** – As we hinted at above in prior luminescent prose that you've had the pleasure of reading, the Bass Level Control is done with the ACR-4 remote. The ACR-4 is the remote level controller that was in the same box as this Epicenter Micro and amazingly enough, we included a pretty long cable for you to run through your car for installing it in the just right position! So plug it in and turn it up!

- 3. LMC Load Select** – The Epicenter Micro's default 20 kΩ input setting is designed to present NO load to the output of the factory amp, which can make some factory amps upset and stop passing audio. The lower impedance options of the Load Selection feature tricks the factory amp into detecting a speaker load so it will continue to pass audio.
  - 20 Ω** – Best suited for late model Dodge/Chrysler/Jeep/Ram/Fiat vehicles equipped with OEM base sound system. (**no separate factory amplifier**)
  - 60 Ω** – Best suited for late model Dodge/Chrysler/Jeep/Ram/Fiat vehicles equipped with a separately amplified OEM "premium" sound system.
  - 20 kΩ** – Best suited for all other applications.

- 4. Internal Balance Jumpers** – The default setting here is the ideal configuration. However, just like Pale Ales, there's a lot of variation from car to car and install to install. On the rare occasion you have noise that the Ground Isolation option didn't resolve, you can remove the top two screws on each side panel and remove the lid and change these jumpers from Balanced to Unbalanced or some combo thereof.
- 5. Trigger mode** – Having options for getting turned on is always a nice thing. Accordingly, the Trigger Mode switch provides you with three ways to set up your turn on mode for The Epicenter Micro:

  - Remote in** – When set to this turn on mode, The Epicenter Micro will only turn on when 12 volts DC is applied to the Rmt (remote) jack
  - GTO** – the Great Turn On™ setting will turn The Epicenter Micro on when the factory system is on. This circuit senses when the factory amp stage is active. Super convenient!
  - Audio** – Setting the Trigger Mode to Audio will turn on The Epicenter Micro when actual audio signal is sensed at the input stage – either at the speaker level or line level inputs.
- 6. Ground Isolation** – On the rare occasion that you can hear the brakes or blinkers or the windshield wipers through your stereo, then you should start here first for some easy troubleshooting. Switching this option around should get rid of noise issues in typical set ups. The default position at the ISO position is for the best but your mileage may vary.
- 7. PFM** – As we've noted before, best be careful with this one. Leaving it to ON and proper gain staging will ensure your subs will live a long life. Bypassing the PFM may shorten the life of your fine sub depending on it's frequency handling capabilities. The PFM filters the lowest frequencies below 20Hz which you can't hear anyway, but if these ultra-low frequencies are present and run through the electron garden of bass enhancement that is The Epicenter Micro, you can do some serious damage to a sub. So, careful.
- 8. Output Voltage** – This setting maximizes the bass performance of the signal while making sure it doesn't exceed some nominal voltage output. The Epicenter Micro will make prodigious bass from the thinnest of signals so you'll want to make sure the downstream signal processor or amp can handle the voltages that this puppy can offer. Check the specs & do some reading - if that downstream device isn't an AudioControl processor or amp, it may not have the best performance with that immense sub signal voltage that The Epicenter Micro will produce.
- 9. Power Terminal Block** – You'll hook up your power, ground, and trigger in and outs here:

  - Ground** – You're a pro, have great style, you know what you're doing with wiring up grounds and know that a good grounding scheme means unwanted noises. Running your ground wire directly to the negative on the battery is best but attaching to the chassis where there is good ground path is perfectly sufficient as well.
  - +12V** – Connect your +12V to a constant to the positive battery terminal.
  - RMT IN** – This is for a 12V trigger source or a switched 12V from a head unit.
  - RMT OUT** – Run this to your amp's 12V trigger or remote input.
- 10. ParaBASS®** – The ParaBASS controls allow you to shape The Epicenter bass restoration effect to your specific application and vehicle acoustics. The Sweep control allows you to select a center frequency (the frequency most affected) between 27 and 63 Hz. The Wide control allows you to control the shape of the filter centered around the Sweep frequency.
- 11. Bass Maximizer LED** – This little yellow LED dances when The Epicenter Micro is doing its job - maximizing bass. How much or how little the LED dances depends on input level from the source. Adjustments to the Bass Maximizer effect from the ACR-4 (outer knob) will have no effect on this LED.
- 12. Output** – Connect these RCAs to your amp and turn it up!

# The Story Behind The Epicenter Micro

**Bass Maximization Technology** – Maybe more than once in a lifetime, you may ask yourself, “Why would I need to restore bass?” The truth is that during the recording process and in the compression process as well as through the various streaming algorithms, low frequency information can be “mixed” down or filtered out. It’s not that recording engineers are out to get you; in fact they are looking out for your best interests and are concerned that many speaker systems cannot handle “truly” low bass information.

The patented circuit inside The Epicenter Micro is designed to reproduce the low frequency information by looking at the upper frequency ranges and detecting musical harmonics. These harmonics then allow The Epicenter Micro to drop down a few octaves and reproduce the “missing” bass notes.

The bottom line is that The Epicenter technology gives you deep, prodigious, body shuddering, heart stopping bass.

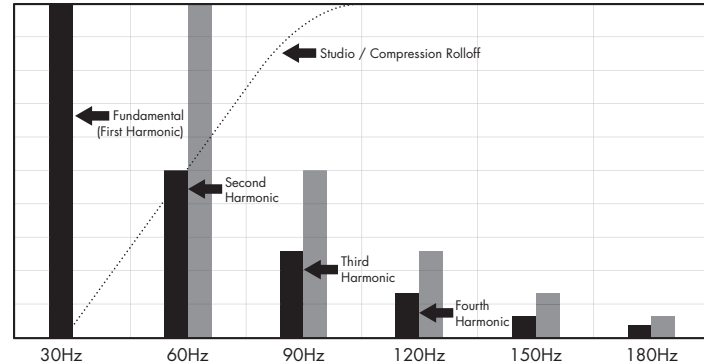

**Pro Tip:** Looking at this graph above, you can see that the Epicenter looks at the higher frequencies to create the effect and ramps up the effect as it moves down the frequency spectrum. When a Low Pass only signal is used, the Epicenter doesn’t get that much signal to work with and loses some of the impact that we designed it to have.

---

## Installation

So now that you have all the detailed operational bits down pat and you're halfway through that Johnny Utah, time to get going on the install details. Like we said before, you're a pro and have the skills to install this bad boy right now. But let's review together those details to ensure you only have to do this once.

**Placement** – The Epicenter needs to be installed in the signal path after the source and BEFORE any crossover circuit. You can have it before or after an EQ but we recommend before so if you need to, you can contour the sound a bit with those controls. Definitely install before the crossover as that will get you the optimal performance from The Epicenter Micro.

**Mounting** – Once you have selected a permanent mounting location, position the unit and mark the appropriate mounting holes with a felt-tip pen or scratch awl. Before doing anything else, make sure you are not about to drill a hole in a gas tank or pierce any existing wiring. Nothing ruins your day more than an expensive repair bill. Drill a small pilot hole and secure the chassis of The Epicenter Micro with self tapping screws

## Power Connections

**WARNING:** Failure to disconnect the negative terminal of your battery prior to the installation of The Epicenter Micro can result in a warm tingly feeling.

**(Pro Tip:** You can remove this Power Terminal connector while wiring up)

**Ground Connection** – Use an 18 gauge wire or larger and run it from the "Ground" connector on The Epicenter Micro to the negative terminal of the battery, a ground bus, or a verified ground location. The factory head unit ground location was designed for the factory system, not your awesome aftermarket additions so don't use that location! When the electrical connections are complete, you may reconnect the negative terminal to your battery.

**Positive(+12V) Connection** – Use an 18 gauge or larger wire and run it from the "+12V" connector of your Epicenter. Connect it to a good constant source of 12 volts (we suggest the battery), fused at 1 amp.

**Remote In** – Labeled "Rmt In." Connect a 22 to 18 gauge wire from the head-unit's remote turn-on or other switch 12v source to the "Remote In" connector on The Epicenter.

**Remote Out** – Labeled "Rmt Out." Connect 22 to 18 gauge wire from this jack to the Remote or 12V trigger input on your amp

## ACR- 4 Dash Control Installation

**Placement and Mounting** – The dash control may be mounted under the dash using its own bracket or through a custom hole in the dash. It should be within reach of the driver and in a spot where the LED is plainly visible.

**Dash Bracket Installation** – The dash control mounts with four screws which attach to the underside of the dashboard. Slide under the dash and place the dash control in its mounting position, mark the four mounting holes, drill pilot holes, and secure with four screws.

**Custom Installation** – For that custom, finished look, the dash control can be flush mounted directly on the dash board (or anywhere else).

Start by removing the two knob set screws and removing the knobs. Remove the two screws securing the enclosure to the bracket and remove the enclosure. Loosen and remove the nut and washer securing the potentiometer to the bracket. Remove the circuit board assembly (potentiometer, LED, phone jack) from the bracket.

Drill a 9/32" hole in the dashboard for the potentiometer along with a 1/8" hole for the lock tab, and a 1/8" hole for the LED. Reassemble the dash control components on the dashboard.

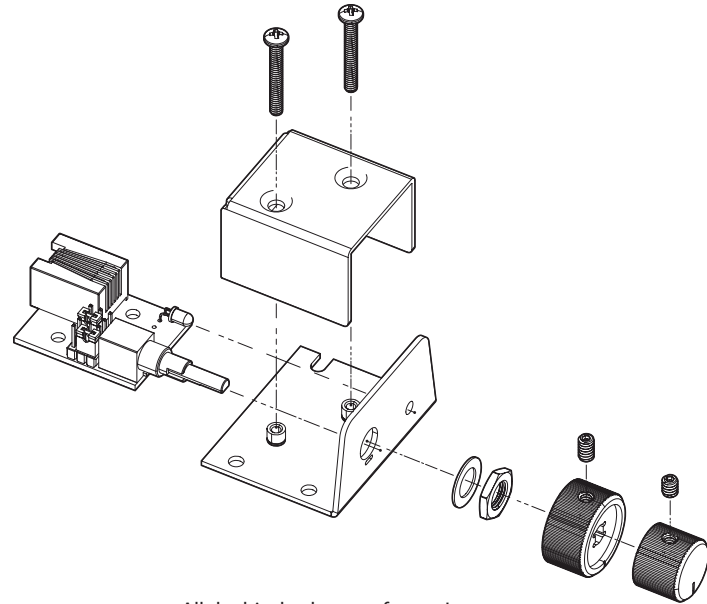

All the bits broken out for you!

## Adjusting the ParaBASS Controls

The bass response in a system is affected by four factors; (1) the acoustics of the vehicle, (2) the location of the speakers, (3) the music or podcast from the source unit, and (4) speakers and speaker enclosures. Because of variations in the recording process, streaming algorithms and compression technologies, we developed The Epicenter circuit to help restore any low frequencies lost during capturing and playback. However, the acoustics of various environments play a most prominent role in what you experience when you play back the “tape”. With this in mind, our coffee-laden engineers developed the unique ParaBASS® system. Use these fantastic quasi-parametric parameters to tune in to your favorite broadcast of the Hits from Ganymede™ & dial in that bass response when those broadcasts are unavailable.

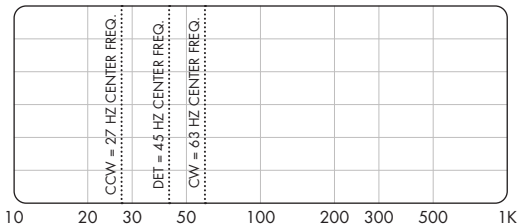
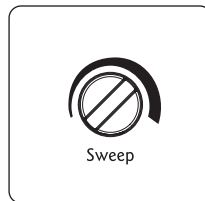

The **Sweep** control allows you to select a center frequency (the frequency most affected) between 27 and 63 Hz.

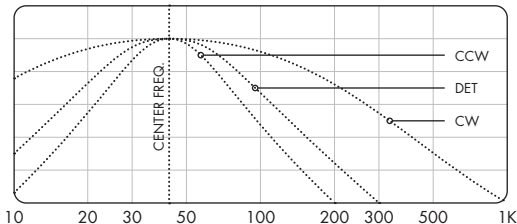
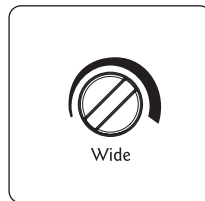

The **Wide** control allows you to control the shape of the filter centered around the Sweep frequency.

## Setting Output & Subsonic Filter Controls

**Bass Output Control** – The Epicenter is the most powerful bass component in the history of autosound. Able to shake tall buildings with a single note and all that kind of stuff. With that in mind we have equipped The Epicenter Micro with several different Voltage Output settings that limit the max voltage output so it doesn't overwhelm your amp or create unwanted distortion. If you should need to change the settings, please use the chart below for guidance. A word of advice: listen to the factory setting before changing your Bass Output settings.

### Recommended Settings

Setting	Amplifier Input Voltage Rating	Minimum Speaker Size
5 Volt	5 Volts or less	8"
7.5 Volt	7.5 Volts or less	10" - 12"
10 Volt	Do they make those?	12" - 32"

**PFM Subsonic Filter** – Many car audio systems truly push the limits of their subwoofer... without really knowing it. *Tuned and or ported enclosures affect the roll-off of many speakers*, yet lots of source material forces the speakers to play lower than expected. The net result is wasted amplifier power and damaged speakers. The AudioControl PFM filter is a subsonic filter set to 20Hz. It allows you to only let the speaker play as low as it should be playing. Because every system is different, your downstream devices like a DSP, analog EQ or amps may have some processing on those ultra low frequencies such that you don't want The Epicenter Micro to filter, we are giving you the option to Bypass this filter. Save yourself a little anguish and look up some info on reproducing frequencies 20Hz and below. Best to be sure about selecting Bypass before engaging this switch. In most any case, the 20 Hz filter will give you the best response but if you need something lower, like a good neighbor, the Bypass switch is there for you.

# System #1: Bass Enhancement for Aftermarket Systems

Aftermarket head unit

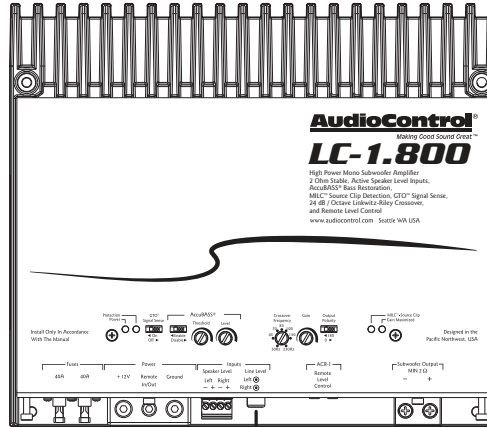
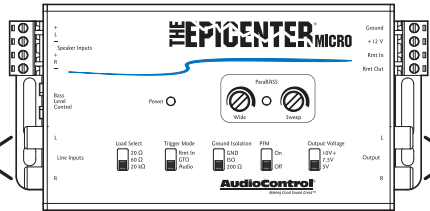
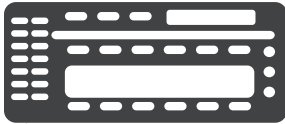

Subwoofer



# System #2: Bass Enhancement for Factory Systems

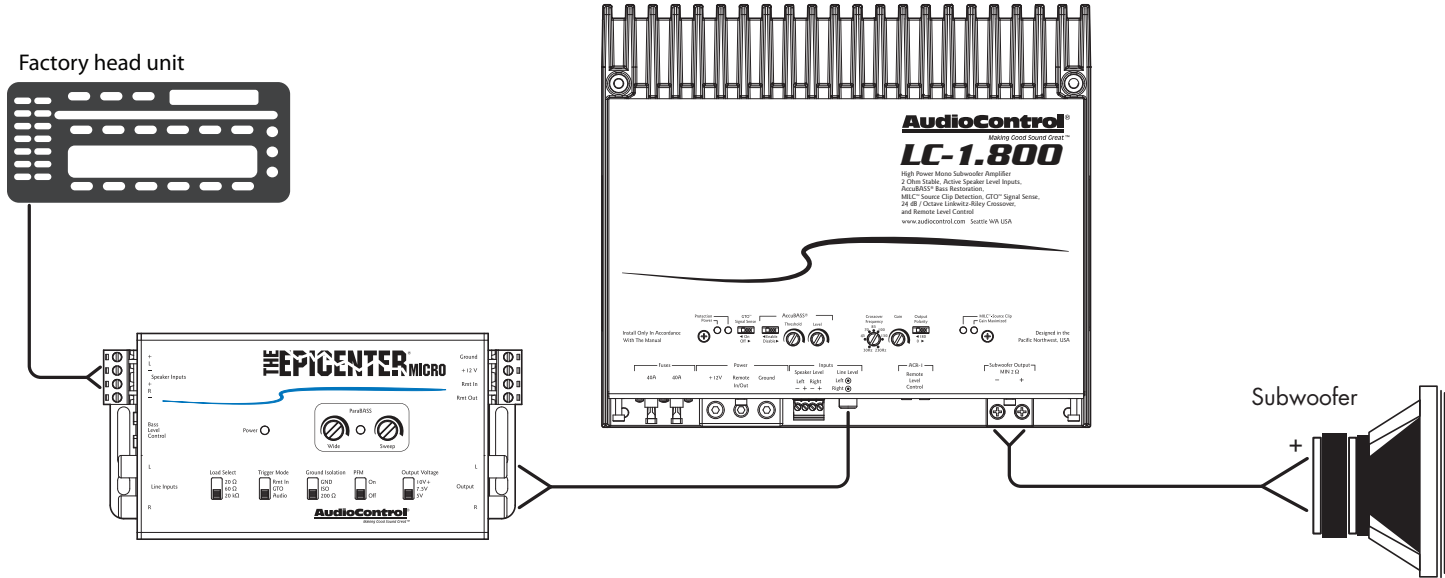

# System #3: Bass Enhancement for Sound Quality Systems

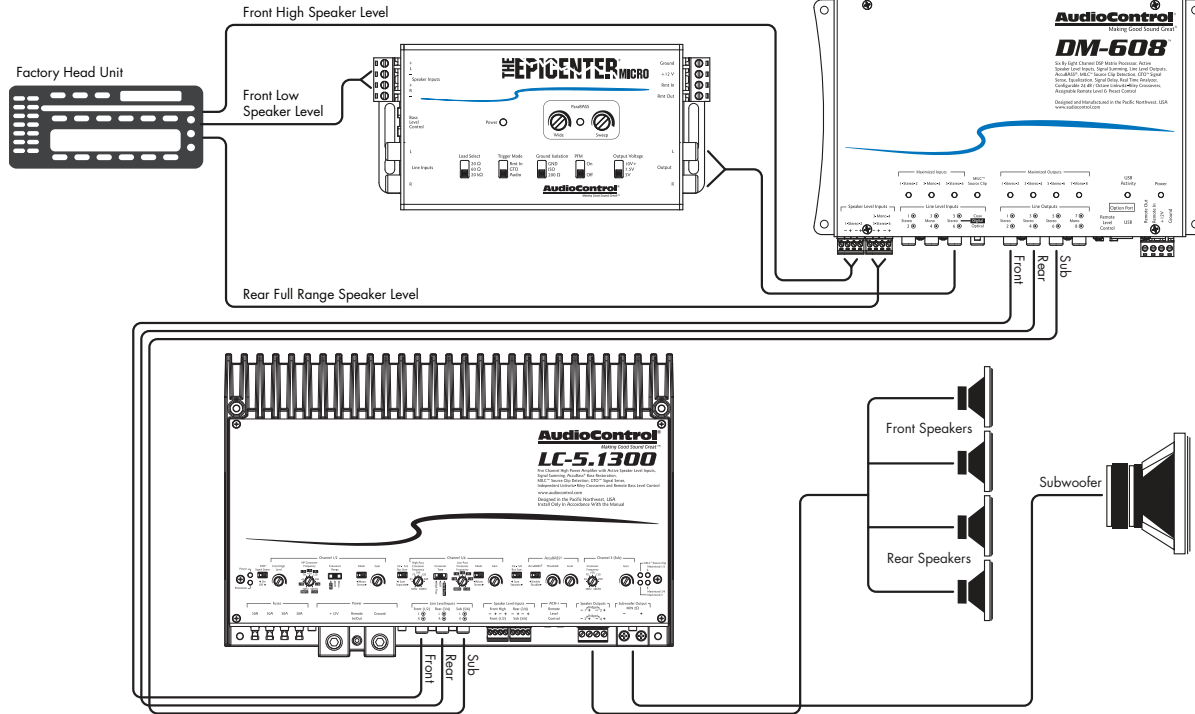

---

## Troubleshooting

**No Power** – If the LED on your dash remote is not on, check the “Power” light on the chassis of The Epicenter Micro. If the “Power” light is on, you will want to check to make sure that the cable connecting the remote to the chassis is not pinched or disconnected. If the “Power” light is off check to make sure that the power wire and remote turn on wires are connected or a fuse has not blown.

**No Restoration** – When your system is playing and yet you don’t hear any difference in the sound, try turning the outer knob clockwise. If you still don’t hear any effect, then you need to make sure that you have The Epicenter Micro in the right part of the signal chain. It must be installed BEFORE any crossovers in the system. Note: If you are using a source unit with a built in crossover or processor, you must run a full range output to The Epicenter Micro’s inputs. Also, check that the ACR-4 cable is plugged in all the way.

**Sounds Distorted** – Should your system sound distorted or your speakers are moving way too much, you should decrease the amount of bass restoration by turning the either knob or both knobs control knob counter-clockwise. If you’ve Bypassed the PFM, probably should re-engage it or lower the setting on your Voltage Output control.

**Still Distorted** – Adjust the Para Bass controls by turning the sweep control clockwise to raise the center frequency. If you still have distortion, you should power down The Epicenter Micro, change the Voltage Output setting to a lower position (i.e. 5 volts).

---

# The Warranty

People are scared of warranties. Lots of fine print, months of waiting around. Well fear no more, this warranty is designed to make you rave about us to your friends. It's a warranty that looks out for you and helps you resist the temptation to have your friend, "...who's good with electronics", try to repair your AudioControl product. So go ahead, read this warranty, then take a few days to enjoy The Epicenter Micro before sending in the warranty card and comments.

"Conditional" doesn't mean anything ominous. The Federal Trade Commission tells all manufacturers to use the term to indicate that certain conditions have to be met before they'll honor the warranty. If you meet all of the conditions, we will warrant all materials and workmanship on The Epicenter Micro for one year from the date you bought it (five years if it is installed by an authorized United States AudioControl dealer). We will fix or replace it, at our option, during that time.

Here are the conditional conditions:

1. You have to fill out the product registration over at our website [www.audiocontrol.com](http://www.audiocontrol.com) and send it to us within 15 days after purchasing The Epicenter Micro.
2. You must keep your sales receipt for proof of purchase showing when and from whom the unit was bought. We're not the only ones who require this, so it's a good habit to be in with any major purchase.
3. The Epicenter Micro must have originally been purchased from an authorized AudioControl dealer. You do not have to be the original owner, but you do need a copy of the original sales slip.
4. You cannot let anybody who isn't: (A) the AudioControl factory; (B) somebody authorized in writing by AudioControl to service The Epicenter Micro. If anyone other than (A) or (B) messes with The Epicenter Micro, that voids your warranty.
5. The warranty is also void if the serial number is altered or removed, or if The Epicenter Micro has been used improperly. Now that sounds like a big loophole, but here is all we mean by it.  
  
Unwarranted abuse is: (A) physical damage (don't use The Epicenter Micro for a car jack - far too small!); (B) improper connections (120 volts into the power jack can fry the poor thing); (C) unreasonable use cases (like hot rodding your oven to pump out low frequency heat waves). This is the best mobile audio product we know how to build, but if you mount it to the front bumper of your car, something will go wrong.
6. The warranty is five years from the date of purchase.

Assuming you conform to 1 through 6, and it really isn't all that hard to do, we get the option of fixing your old unit or replacing it with a new one.

# Specifications

All specifications are measured at 14.4 VDC (standard automotive voltage). As technology advances, AudioControl reserves the right to continuously change our specifications, like our Pacific Northwest weather, although we are working on a surround-sound umbrella as well.

## The Epicenter Micro

### Inputs

Maximum Input Line Level (RCA)	15Vrms
Maximum Input Speaker Level	40V/400W (20K Ω setting)
Input Impedance Line Level	7kΩ
Input Impedance Speaker Level	Selectable 20Ω, 60Ω, 20kΩ

### Outputs

Preamp Outputs	1 pair
Max Output Level	13V Peak
Output Impedance	150Ω

### Performance

THD	.003%
Frequency Response	10Hz to 22kHz, +/- 1dB
Signal to Noise Ratio	>105dB
PFM Filter	Bypass or 20Hz

### General

Power Supply	High Headroom PWM Switching
Current Draw	300mA
Recommended Fuse	1A
Weight	0.6 lbs
Dimensions	5.12" W x 3" D x 1" H

For more information about this fine product, and for details of the limited warranty and repair services, please visit [www.audiocontrol.com](http://www.audiocontrol.com)

AudioControl, Inc.  
 22410 70th Avenue West  
 Mountlake Terrace, WA 98043 USA  
 Phone: 425-775-8461  
 email: [sound.great@audiocontrol.com](mailto:sound.great@audiocontrol.com)

©2021 AudioControl. All rights reserved.

All specifications are subject to being covered in hot sauce without notice.