

Owner's Manual & Safety Instructions

Save This Manual Keep this manual for the safety warnings and precautions, assembly, operating, inspection, maintenance and cleaning procedures. Write the product's serial number in the back of the manual near the assembly diagram (or month and year of purchase if product has no number). Keep this manual and the receipt in a safe and dry place for future reference.

22e

Bauer™

2209C-B

20v

HYPERMAX™ LITHIUM



190 WATT POWER SOURCE BATTERY INVERTER

Visit our website at: <http://www.harborfreight.com>
Email our technical support at: productsupport@harborfreight.com

59299

When unpacking, make sure that the product is intact and undamaged. If any parts are missing or broken, please call 1-888-866-5797 as soon as possible.





Copyright © 2022 by Harbor Freight Tools®. All rights reserved.

No portion of this manual or any artwork contained herein may be reproduced in any shape or form without the express written consent of Harbor Freight Tools. Diagrams within this manual may not be drawn proportionally. Due to continuing improvements, actual product may differ slightly from the product described herein. Tools required for assembly and service may not be included.

⚠ WARNING

Read this material before using this product. Failure to do so can result in serious injury. SAVE THIS MANUAL.

WARNING SYMBOLS AND DEFINITIONS

	This is the safety alert symbol. It is used to alert you to potential personal injury hazards. Obey all safety messages that follow this symbol to avoid possible injury or death.
	Indicates a hazardous situation which, if not avoided, will result in death or serious injury.
	Indicates a hazardous situation which, if not avoided, could result in death or serious injury.
	Indicates a hazardous situation which, if not avoided, could result in minor or moderate injury.
	Addresses practices not related to personal injury.

IMPORTANT SAFETY INSTRUCTIONS - SAVE THESE INSTRUCTIONS** WARNING**

Read all safety warnings, instructions, illustrations and specifications provided with this tool.

Failure to follow all instructions listed below may result in electric shock, fire and/or serious injury.

- Output non-sinusoidal.
- Do not obstruct ventilation openings or mount in zero clearance compartment. Overheating may increase the risk of fire and electric shock.
- Do not expose to rain or use in damp locations.
- Remove the battery before servicing.
- Neutral floating.
- For use with Bauer 20V Li-Ion battery packs (sold separately).
- Do not use inverter if it has been dropped or impacted sharply. Use of a damaged device increases the risk of fire.
- Remove the battery pack from the inverter when not in use.
- Do not disassemble the battery inverter.
- Keep out of the reach of children.
- Store power inverter indoors and out of the reach of children.
- AC Output must be used for powering devices of 150W or less. Connecting large loads to the inverter can lead to damage.
- Plugs must properly fit the outlet without being forced. Do not insert any plug into the inverter if it does not fit easily into place.
- Power inverter must be kept in cool environment. Keep away from heat.
- Do not use power inverter near flammable gases or fumes. Do not power medical equipment with this power inverter.
- Recharge only with the charger specified by the manufacturer. A charger that is suitable for one type of battery pack may create a risk of fire when used with another battery pack.
- Use inverter only with specifically designated battery packs. Use of any other battery packs may create a risk of injury and fire.
- When battery pack is not in use, keep it away from other metal objects, like paper clips, coins, keys, nails, screws or other small metal objects, that can make a connection from one terminal to another. Shorting the battery terminals together may cause burns or a fire.
- Under abusive conditions, liquid may be ejected from the battery; avoid contact. If contact accidentally occurs, flush with water. If liquid contacts eyes, additionally seek medical help. Liquid ejected from the battery may cause irritation or burns.
- Do not use a battery pack or inverter that is damaged or modified. Damaged or modified batteries may exhibit unpredictable behavior resulting in fire, explosion or risk of injury.

21. Do not expose a battery pack or power inverter to fire or excessive temperature. Exposure to fire or temperature above 140°F may cause explosion.
22. Follow all charging instructions and do not charge the battery pack outside of the temperature range specified in the instructions. Charging improperly at temperatures outside of the specified range may damage the battery and increase the risk of fire.
23. Have servicing performed by a qualified repair person using only identical replacement parts. This will ensure that the safety of the product is maintained.
24. Do not modify or attempt to repair the inverter or the battery pack except as indicated in the instructions for use and care.

25.  The battery Charger gets hot during use. The Charger's heat can build up to unsafe levels and create a fire hazard if it does not receive adequate ventilation, due to an electrical fault, or if it is used in a flammable environment. Do not place the Charger on a flammable surface. Do not obstruct any vents on the Charger. **Especially avoid placing the Charger on carpets and rugs; they are not only flammable, but they also obstruct vents under the Charger.** Place the Charger on a stable, solid, nonflammable surface (such as a stable metal workbench or concrete floor) at least 1 foot away from all flammable objects, such as drapes or walls. Keep a fire extinguisher and a smoke detector in the area. Frequently monitor the Charger and Battery Pack while charging.

Lithium Battery Safety Warnings







LITHIUM BATTERIES STORE A LARGE AMOUNT OF ENERGY AND WILL VENT FIRE OR EXPLODE IF MISTREATED:



- a. **Keep Battery Pack dry.**

b. DO NOT DO ANY OF THE FOLLOWING TO THE BATTERY PACK:

- Open,
 - Drop,
 - Short-circuit,
 - Puncture,
 - Incinerate, or
 - Expose to temperatures greater than 140°F.
- c. Charge Battery Pack only according to its Charger's instructions.
- d. Inspect Battery Pack before every use; do not use or charge if damaged.

Symbology

	Volts
	Direct Current
	Alternating Current
A	Amperes
	WARNING marking concerning Risk of Eye Injury. Wear ANSI-approved safety goggles with side shields.
	Read the manual before set-up and/or use.

	WARNING marking concerning Risk of Fire. Do not cover Charger ventilation ducts. Charge on fireproof surface only.
	WARNING marking concerning Risk of Electric Shock. Properly connect Charger's power cord to appropriate outlet.
	WARNING marking concerning Risk of Explosion. Do not puncture, short, or open battery packs and do not charge damaged battery packs.

Specifications

Battery Type	Bauer 20V Li-Ion (sold separately)
Charger Type	Bauer 20V Li-Ion (sold separately)
DC Input	20VDC, 11A
AC Output	120VAC, 60Hz, 150W
Output Wave	Modified Sine Wave
USB-A Output	5VDC, 2.4A (total)
USB-C with PD Output	5VDC, 3A; 9VDC, 3A; 12VDC, 2.5A; 15VDC, 2A
Integrated LED Work Light	Yes
Operation Temperature Range	14°F ~ 104°F (-10°C ~ 40°C)
Storage Temperature Range	-4°F ~ 140°F (-20°C ~ 60°C)

Bauer[™]

Functions

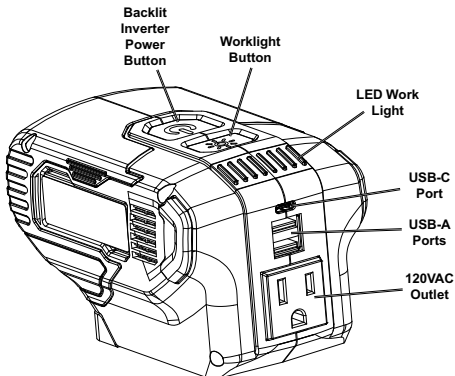

Power Button - Inverter Status	
Green	Normal Function
Red	AC Overload
Red Blinking	Overheating
Green Blinking	Recovering from overheating. Press Power Button to reset.
Orange Blinking	Approaching Low Battery
Worklight Button	
First Press	On
Second Press	Blinking
Third Press	Off

Operating Instructions



Read the **ENTIRE IMPORTANT SAFETY INFORMATION** section at the beginning of this manual including all text under subheadings therein before set up or use of this product.

General Operation

Only use with:

- Laptops, Tablets, and Cell Phones.
- Fans.
- Lights.
- Other devices of 150W or less.

1. Slide the Battery Pack onto the Inverter.
2. Connect a device to a USB Charging Port, or the AC Outlet.

Note: If the AC output is overloaded, the power button backlight will be red, remove the connected load and press the power Button to restore AC output

3. Turn the Inverter ON/OFF by pressing the Power Button.

Note: Inverter will shutdown when no activity is detected for 3 minutes.

Note: Cooling fan will automatically turn ON and OFF during operation. AC output will shut off if overheated.

Maintenance and Servicing Instructions



Procedures not specifically explained in this manual must be performed only by a qualified technician.

Cleaning, Maintenance, and Lubrication

1. Li-Ion BATTERY MUST BE RECYCLED OR DISPOSED OF PROPERLY.
Do not short, incinerate or open battery.
2. Disconnect battery pack and store battery pack, charger, and tool in dry, indoor area out of reach of children and away from metal objects (i.e., paperclips, coins) to prevent shorting.

Bauer[™]

Troubleshooting

Problem	Possible Causes	Likely Solutions
Inverter will not turn on.	<ol style="list-style-type: none"> 1. Battery Pack not properly connected. 2. Battery Pack not properly charged. 3. Battery Pack burnt-out. 	<ol style="list-style-type: none"> 1. Remove Battery Pack, make sure there are no obstructions, reinsert the Battery Pack according to its shape (it should only fit one way), and press firmly until the Battery Pack locks in place. 2. Make sure Charger is connected and operating properly. Give enough time for Battery Pack to recharge properly. 3. Dispose of old Battery Pack properly or recycle. Replace Battery Pack.
No AC Output	<ol style="list-style-type: none"> 1. Inverter is overloaded. 2. Defective device connected 	<ol style="list-style-type: none"> 1. Check if inverter output rating has been exceeded. 2. Try a different device.
WorkLight not working.	Power Switch is OFF.	Power Switch must be ON for Worklight to work.
USB-C will not charge device.	Device may require 20V to charge, this inverter provides up to 15V through USB-C.	Check device operator's manual and verify that 20V is not required for charging.
Overheating.	Blocked vents.	Keep all vents clear for proper ventilation. Wear ANSI-approved safety goggles and NIOSH-approved dust mask/respirator while blowing dust out of unit while using compressed air.
 <p>Follow all safety precautions whenever diagnosing or servicing the tool. Disconnect Battery Pack power supply before service.</p>		

Record Serial Number Here:

Note: If product has no serial number, record month and year of purchase instead.

Note: Replacement parts not available. Refer to UPC 193175465474.

Limited 90 Day Warranty

Harbor Freight Tools Co. makes every effort to assure that its products meet high quality and durability standards, and warrants to the original purchaser that this product is free from defects in materials and workmanship for the period of 90 days from the date of purchase. This warranty does not apply to damage due directly or indirectly, to misuse, abuse, negligence or accidents, repairs or alterations outside our facilities, criminal activity, improper installation, normal wear and tear, or to lack of maintenance. We shall in no event be liable for death, injuries to persons or property, or for incidental, contingent, special or consequential damages arising from the use of our product. Some states do not allow the exclusion or limitation of incidental or consequential damages, so the above limitation of exclusion may not apply to you. THIS WARRANTY IS EXPRESSLY IN LIEU OF ALL OTHER WARRANTIES, EXPRESS OR IMPLIED, INCLUDING THE WARRANTIES OF MERCHANTABILITY AND FITNESS.

To take advantage of this warranty, the product or part must be returned to us with transportation charges prepaid. Proof of purchase date and an explanation of the complaint must accompany the merchandise. If our inspection verifies the defect, we will either repair or replace the product at our election or we may elect to refund the purchase price if we cannot readily and quickly provide you with a replacement. We will return repaired products at our expense, but if we determine there is no defect, or that the defect resulted from causes not within the scope of our warranty, then you must bear the cost of returning the product.

This warranty gives you specific legal rights and you may also have other rights which vary from state to state.

Bauer[™]

26677 Agoura Road • Calabasas, CA 91302 • 1-888-866-5797