



# INSTALLATION GUIDE

**PART NUMBER: 152600**  
**LIFT KIT**  
**FORD BRONCO 4WD | 2021+**

RIDE HEIGHTS ARE KIT SPECIFIC

152600TP: 4" to 7.5"

152600HK: 4" to 7.5"

152600BK: 6"

**300 W. PONTIAC WAY. CLOVIS, CA 93612**  
**PHONE: 800-445-3767 | EMAIL: INFO@BELLTECH.COM**

# THANK YOU

Thank you for choosing our high quality Belltech product. We have spent a great deal of time developing our line of products so that you will receive maximum performance with minimal difficulty during installation. Soon your vehicle will be on the road looking and feeling much improved.

**Please take a moment to read all instructions and warnings prior to installation of your new Belltech product and before operating your vehicle. If you have any questions or concerns regarding any step in the installation process, please do not hesitate to call or email our customer support specialists who are trained to help you through any portion of this process.**

## Before You Begin:

**It is of the utmost importance that you confirm all of the components listed on the parts list is in the kit. You can find this list located on the last page(s) of your instructions. Do not begin installation if any part is missing. Instead, please call our Belltech customer service specialists.**

### Belltech Customer Support:

Phone: 1-800-445-3767

Email: [info@belltech.com](mailto:info@belltech.com)

## Safety Information:

**Warning:** Do not work under a vehicle supported only by a jack. Place support stands securely under the vehicle in the manufacturer's specified locations unless otherwise instructed.

Proper use of safety equipment and eye/face/hand protection is absolutely necessary when performing any of the following instructions.

We strive for an exceptional experience for all our valued customers. If for any reason you need assistance with your Belltech products, please do not return the product to the store you purchased from, but rather call our dedicated customer service experts, from 7am to 5pm PST.

We recommend that a qualified mechanic, at a properly equipped facility, perform this installation.

It is very helpful to have an assistant available during installation.

## Before Driving Your Vehicle:

It is important to double check all brake hoses, cables, and other components to be sure there is no interference. You must also check for wheel/tire to chassis/body interference. If any issues are found, review your installation instructions to be sure no steps were missed and any problems are corrected.

Make sure your vehicle is aligned immediately following installation.

Check all hardware and re-torque at intervals for the first 10, 100, and 1000 miles.

Some of Belltech's products are designed to improve your vehicle's off-road performance. Leveling/lifting your vehicle may result in an altered center of gravity. It is crucial to use extreme care when operating your vehicle to prevent rollover and/or loss of control.

Any changes in your vehicle's suspension may result in transformed handleability. Please test-drive your vehicle in a remote location so you can become accustomed to the revised driving characteristics.

Perform headlight check and adjustment.

Failure to drive any modified vehicle in a safe manner may result in harm or death.

Never operate your modified vehicle under the influence of drugs, alcohol, or lack of adequate sleep.

Always wear your seatbelt.



**DIFFICULTY:**

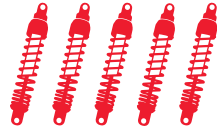

**INSTALLATION TIME:**

10 - 12 Hours  
+ Alignment

## RECOMMENDED TOOLS:

- Properly rated floor jack
- Ratcheting socket wrench and socket set
- Hammer
- Sawzall and/or angle grinder with cutoff discs
- Flat head screwdriver or pry tool
- Support stands
- Wheel chocks
- Metric wrench set
- Tape measure
- Paint Pen
- Safety glasses
- Metal file and sandpaper
- Black spray paint

## SPECIALTY TOOLS:

- High quality spring compressor
- Torque wrench up to 200 ft lbs.
- Ball joint separator
- Ball peen hammer
- Center punch



## FITMENT GUIDE

### All 4.5" lifts:

18x9 w/ 5-1/2" BS—35x12.50

20x9 w/ 5-1/2" - 6-1/4" BS—35x15.50

### All 7" Lifts:

18x9 w/ 5-1/2" BS—35x12.50

20x9 w/ 5-1/2" BS—35x12.50

20x9 w/ 6-1/2" BS—37x12.50

## INSTALLATION PREPARATION:

Before beginning the installation process, measure the hub to fender heights for your vehicle and record them in the "Before" section. After your vehicle has been modified, record the new measurements in the, "After" section. This way, you can compare the resulting height to the original. When taking the measurements, measure vertically from the center of the wheel to the inner edge of the fender.

**Before:**

LF: \_\_\_\_\_

RF: \_\_\_\_\_

LR: \_\_\_\_\_

RR: \_\_\_\_\_

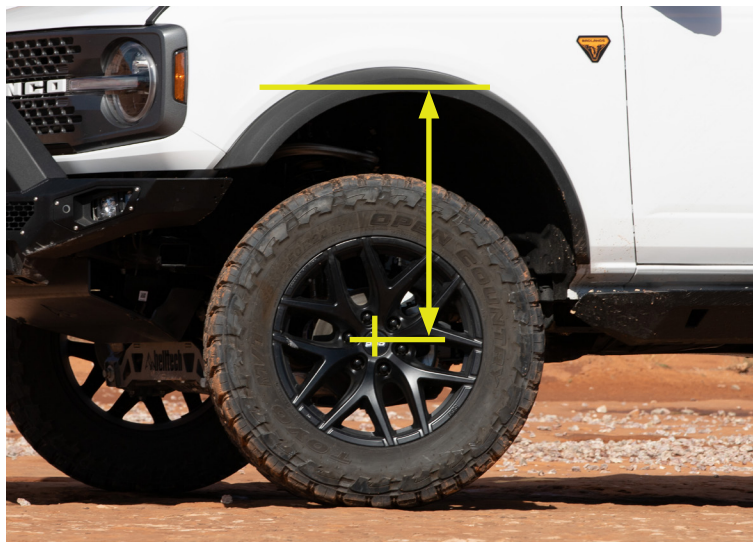

**After:**

LF: \_\_\_\_\_

RF: \_\_\_\_\_

LR: \_\_\_\_\_

RR: \_\_\_\_\_

# JACKING, SUPPORTING, AND PREPARING THE VEHICLE

1. Park your vehicle on a smooth, level, concrete or seasoned asphalt surface.
2. Block the rear wheels of the vehicle using wheel chocks. Make sure the vehicle's transmission is in "PARK" (automatic) or 1st gear (manual).
3. Activate the parking brake.
4. Break loose, but do not spin the wheel lug nuts to ease in removal when the wheels are in the air.
5. Lift the front of the vehicle off the ground using a properly rated floor jack. Lift the vehicle so the front tires are approximately 6-8 inches off the ground.
6. Place support stands rated for the vehicles weight. The stands should be positioned in the factory specified locations. (Refer to the owners manual). Prior to lowering the vehicle onto stands, make sure the support stands will contact the chassis. It is very important that the vehicle is properly supported to prevent any harm to ones self or to the vehicle.
7. Lower the vehicle slowly onto the stands.
8. Remove the front wheels.



## Technician reminder:

Never work under a vehicle supported only by a jack. It is necessary to place support stands securely under the vehicle in the manufacturer's specified locations unless otherwise instructed.

## FITMENT NOTE:

**\*During the rear suspension installation, the fuel tank will need to be lowered. To ease the process we suggest a low fuel tank level before starting the installation. \***

# FRONT SUSPENSION REMOVAL

9. Remove the front skid plate.
10. Detach the front sway bar assembly by unbolting the end links and brackets securing it to the vehicle. For vehicles equipped with hydraulic sway bars, it is important to remove the sway bar assembly carefully to prevent damage to the wires or connectors.
11. Remove the steering tie rod end nut with a 21mm socket from the spindle. Use a tie rod end remover to carefully detach the tie rod end from the spindle. Alternatively you can strike the spindle with a hammer to remove the tie rod end. Do not hit the boot.

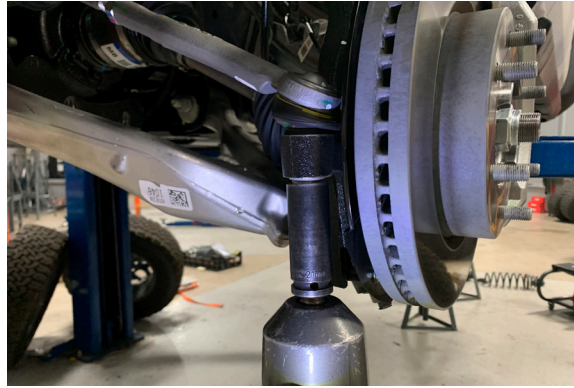

12. 11. Using a 8mm socket, detach the the wheel speed sensor from the spindle. Secure the wire assembly away from the working space.

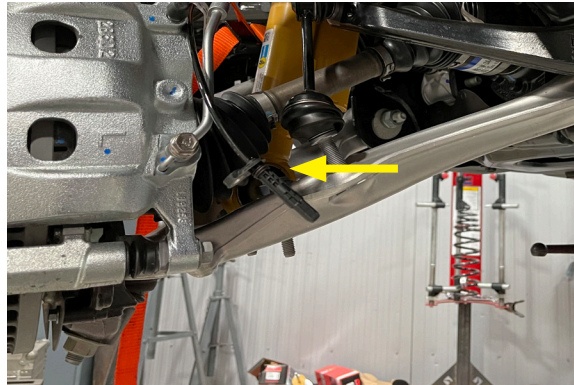

13. Using a 10mm wrench, detach the front ABS and brake line bracket from the spindle and remove the bracket from the chassis.

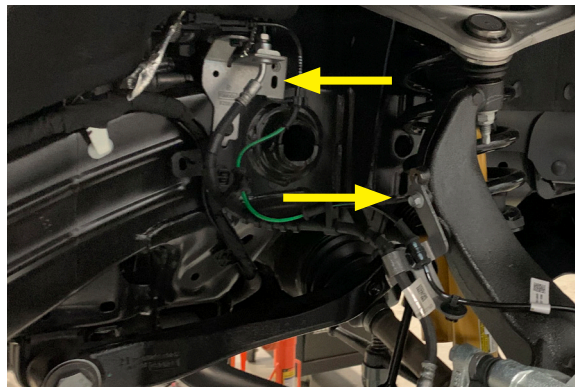

## FRONT SUSPENSION REMOVAL CONTINUED

14. Remove the 18mm brake caliper bolts and hang the caliper securely in the wheel well to prevent from overstretching the brake hoses.

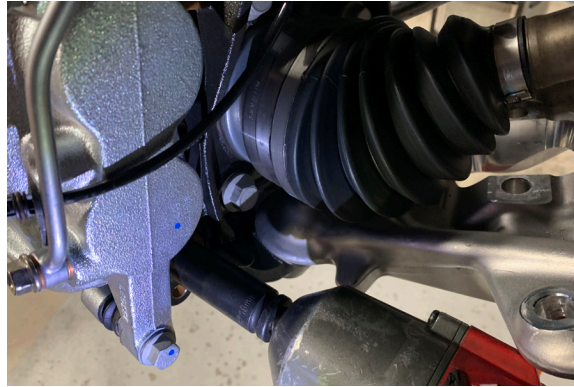

15. Remove the brake rotor from the Hub.
16. With a 36mm socket, remove the CV axle nut. Ensure the axle is dislodged from the spindle by striking the center of the axle with a punch and hammer. Ensure the threads are not damaged in the process.



### Technician reminder:

Be sure to support the lower control arm and spindle assembly to prevent overextending the CV axle shaft or causing other damage.



17. Break loose but do not remove the upper and lower ball joint 18mm nuts. Use a ball joint separator tool to detach the ball joints from the spindle. Alternatively with a hammer, you can strike the ball joint boss on the spindle to remove the ball joint.



## FRONT SUSPENSION REMOVAL CONTINUED

18. It is important to be careful, as the control arms may be under tension. Once free, support the spindle as you remove the upper and lower ball joint nuts. Allow the spindle to droop as you slide the axle shaft out of the hub.



19. Remove the 18mm bolts fastening the hub to the OEM spindle. Detach the hub and backing plate then mount them onto the new Belltech spindle using the original hardware. Torque the four bolts to 129 ft lbs.



20. Remove the three 15mm top mount nuts holding the strut to the chassis and the two lower strut 18mm nuts. Lower the control arm assembly to gain clearance for the strut to be removed from the vehicle.



## FRONT SUSPENSION REMOVAL CONTINUED

21. Before removing the lower control arms, use a marking pen to mark the alignment cams to reference the original placement later.
22. With 24mm and 21mm wrenches, remove the lower control arms bolts and detach the arms from the vehicle.



23. Disconnect all hoses and connectors from the front differential. This will prevent damage or over stretching to any hoses, lines, or cables. (This step will vary depending on the vehicles equipped options.)

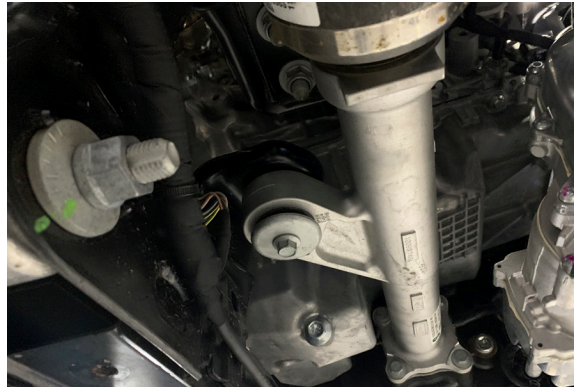

24. Before removing the drive shaft, use a marking pen to mark the position of the drive shaft and the yoke to reference the original placement later.
25. Support the drive shaft with a jack to avoid excessive droop and unnecessary stress on the joints.
26. Remove the six T45 Torx bolts from the drive shaft and detach the front drive shaft from the front differential.



# FRONT SUSPENSION REMOVAL CONTINUED

27. Securely support the front differential with a jack, then remove the passenger side differential support 13mm bolt two and the two 18mm bolts on the back of the differential above the input shaft.

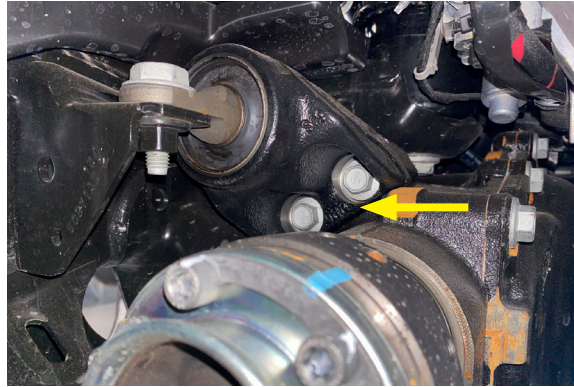

28. Remove the front differential mount 21mm bolt holding the differential to the bracket then carefully lower the differential to place it aside safely. Ensure to check for any missed wires or hoses while lowering the differential.
29. Remove the differential mounting bracket from the chassis with a 18mm socket.
30. Begin on the drivers side, use a paint pen to mark the vertical lines to cut on front side of the rear cross member. Measure from the drivers side flange horizontally (reference figure 1). The inner cut line near the center of the vehicle can be wrapped around the cross member. The outer cut line must go around the front of the rear cross member only up to the seam weld (reference figure 2).

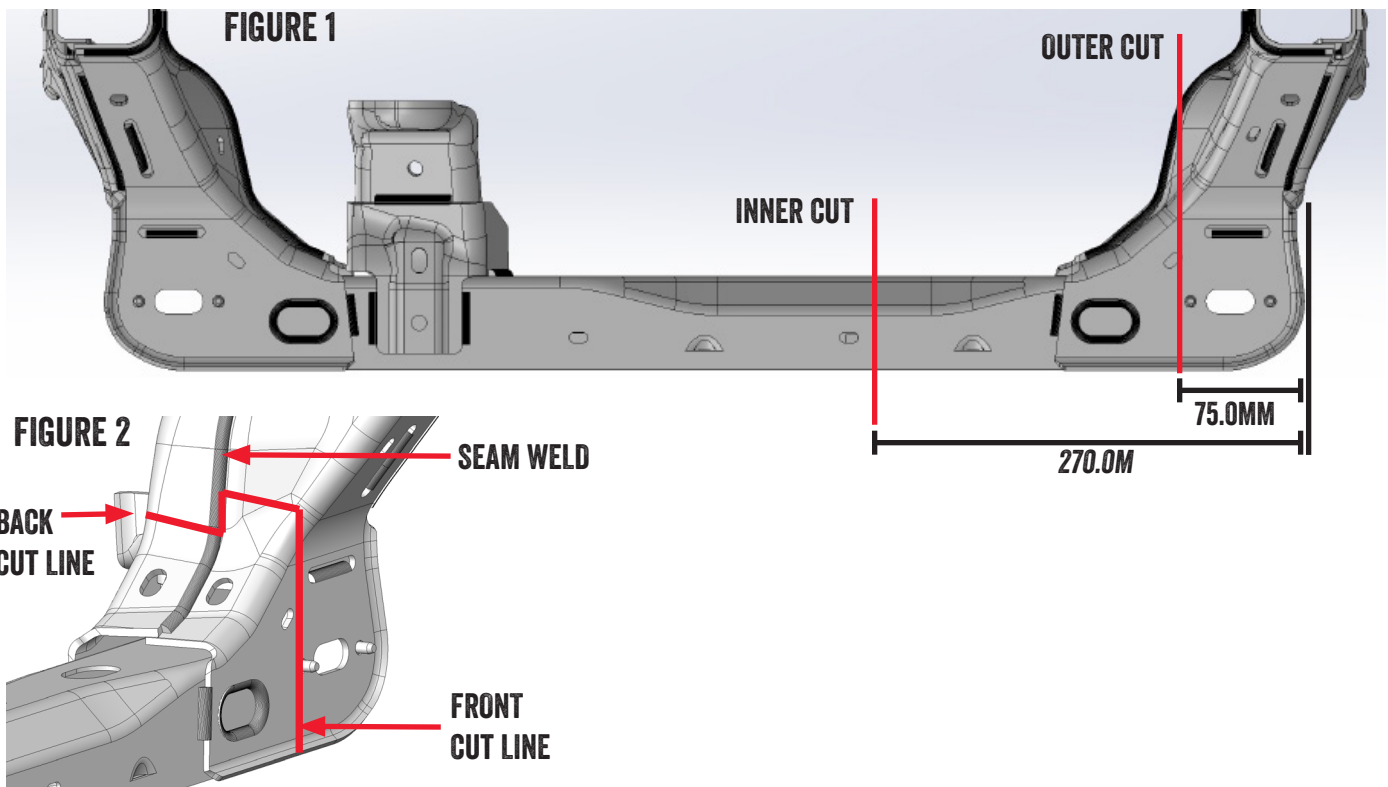

31. On the back side of the rear cross member, measure 7mm inward from the inner alignment pin and mark a vertical line, then wrap the paint pen line up and around to the seam weld. The two lines will be offset and not meet. Connect the two lines along the seam weld.

# FRONT SUSPENSION REMOVAL CONTINUED

32. Use a reciprocating saw with a long metal cutting blade to cut along the marked lines. It may be helpful to use a cut off disc on a angle grinder to score the marked lines before using the reciprocating saw. Remove the center section of the rear cross member.



## Technician reminder:

It is important to smooth out the cut with a file or sandpaper then spray paint the exposed metal to prevent corrosion.

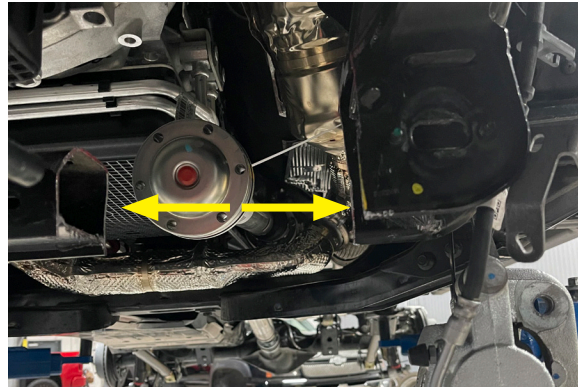

33. To add clearance on the differential, use a grinder to remove the small lobe near the rear upper mounting holes (reference the images below).

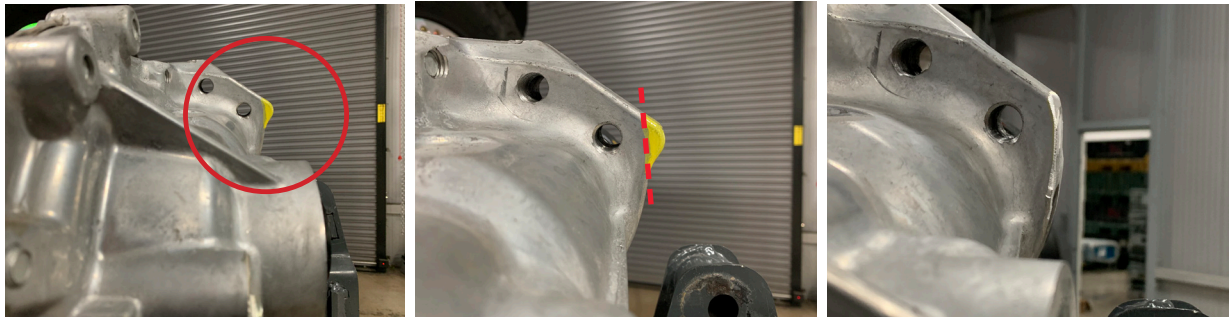

34. If the front differential has the large coupler on the passenger side, you must cut off or grind the small aluminum protrusion on the back side of your power steering rack as shown (reference the images below).

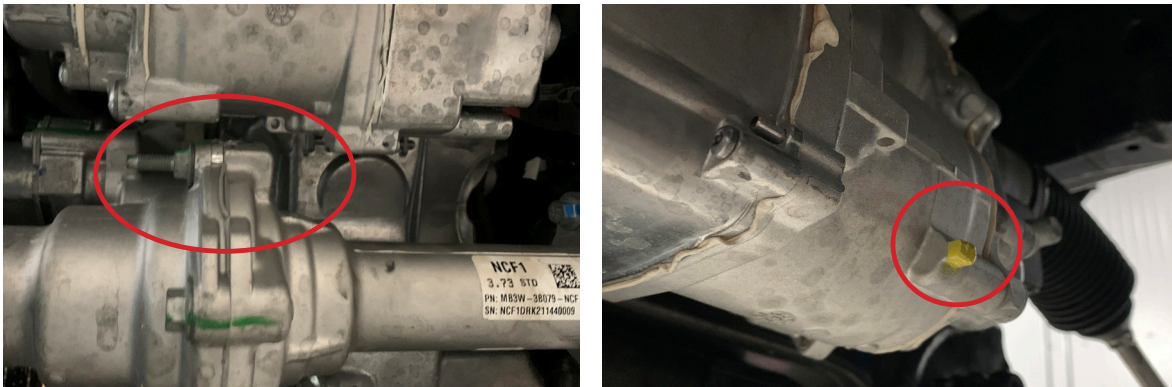

# FRONT SUSPENSION INSTALLATION

35. Install the Belltech front skid plate using the OEM front skid plate hardware. Mount the plate between the Belltech cross member and chassis.
36. Mount the Belltech front and rear cross members using the supplied hardware.



## Technician note:

Assembly of the front end will be performed in the reverse order of removal. To help, reference the images from pages 4-8.

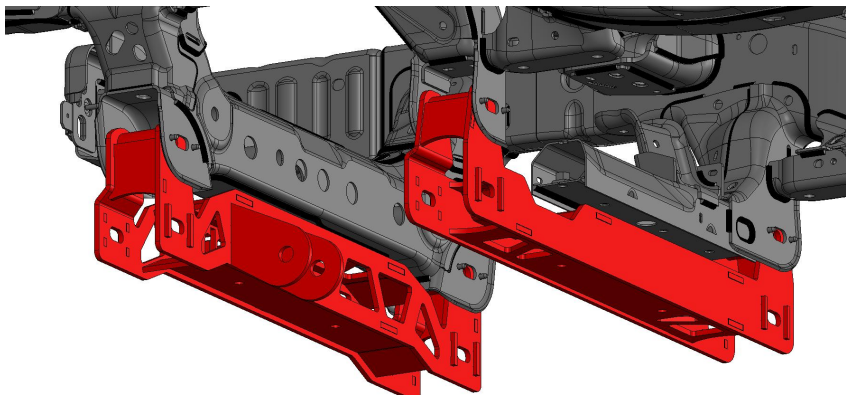

37. Raise the differential into place between the cross members. Mount the differential but do not fully tighten the front and passenger side differential bolts.
38. Install the rear differential mount plate with the cut out notch facing inward and upward. Use the OEM bolts on the bottom and the supplied bolts on top.
39. Ensure a minimum 5mm of clearance between the side of the differential and the cut section of the frame. Also ensure a minimum of 5mm clearance between the power steering rack and the large differential coupler on the passenger side (if applicable).



40. Tighten and torque all differential bolts to OE specs. Reconnect all electrical connections and hoses.
41. Install the Belltech drive line spacer between the front drive shaft and the differential with the provided extended length hex socket head bolts.



## FRONT SUSPENSION INSTALLATION CONTINUED

42. Depending on the kit that was ordered, reference the individual instructions now and install the spacer, strut, or coilover set that was included with your kit.
43. Attach the lower control arms using the original Hardware. To prevent the bushings from being overstressed or hold unwanted height, do not torque the control arms until the vehicle is on the ground.



44. Install the new assembled Belltech spindle onto the upper and lower ball joints using the original nuts. Torque the lower ball joint nut to 85 ft lbs. and the upper ball joint nut to 46 ft lbs. Ensure to reattach the brake backing plate that was previously removed.
45. Install the new Belltech brake line drop brackets to the chassis then attach the original bracket onto the new bracket. Ensure brake lines and wires do not catch on any moving parts or stretch while turning.

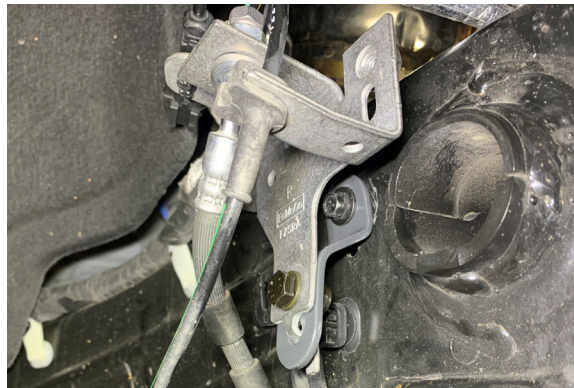

46. Attach the wheel speed sensor to the spindle and torque to 71 *in lb*.
47. Mount the brake rotor to the hub and install the brake caliper with the original bolts. Torque to 48 ft lbs. Check again for any wires or brake lines that could catch on other components or interfere when turning.
48. Attach the outer tie rod end onto the spindle and torque the outer tie rod end nut to 46 ft lbs.

## FRONT SUSPENSION INSTALLATION CONTINUED

49. Attach the new Belltech sway bar drop down brackets onto the chassis using the original nuts and bolts. Torque to 66 ft lbs.



50. Mount the sway bar onto the drop brackets using the provided hardware, torque to 66 ft lbs. Attach the end links to the lower control arms with the original hardware, torque to 111 ft lbs.
51. Install the Belltech lower skid plate using the supplied hardware. If your vehicle is equipped with a sway bar skid plate, the new Belltech skid plate is mounted between the original skid plate and the rear cross member.



52. Double check all fastening hardware and ensure no steps have been missed.
53. Mount the wheels and lower the front end to the ground.

# REAR SUSPENSION REMOVAL



## Technician reminder:

During the rear suspension installation, the fuel tank will need to be lowered. To ease the process we suggest a low fuel tank level before starting the installation.

54. Prior to the rear installation, set all Belltech adjustable rear suspension links to the recommended base lengths using the tables below. Tighten the jam nuts before you install on the vehicle.



## Technician reminder:

The Belltech recommended lengths are not absolute. They are a suggestion and can be further tuned to achieve the driving and alignment characteristics of the vehicle. A professional alignment must be performed to ensure safe operation of your vehicle.

Suspension link	Suggested length
Rear Track Bar	Match to OEM Bar
Rear Upper Control Arm	380mm
Rear Lower Control Arm	673mm

55. Lift the rear of the vehicle and support it with jacks using the manufacturers recommended procedure.
56. Remove the fender liners with a Phillips screw driver.
57. Support the rear axle and remove the rear track bar with a 24mm socket, keep the original hardware to use for installation.



58. Remove the rear struts (reference the individual instructions included with your kit).
59. Detach the driver side rear exhaust hanger bracket from the chassis.

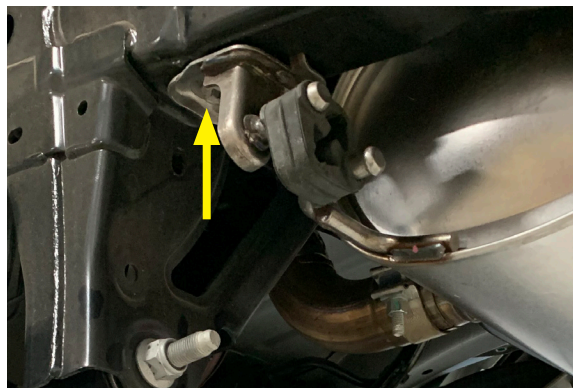

# REAR SUSPENSION INSTALLATION



## Technician reminder:

For kits that include a track bar bracket with a single lower setting, this is preset for the desired lift range, adjustment is not needed.

For kits that include a track bar bracket with three settings, use the table to the right to achieve the desired lift.

Desired Lift (in)	Track Bar Mount Setting
3" - 4"	Upper
4" - 5"	Middle
5" - 6.5"	Lower

60. Mount the Belltech rear roll center correction bracket around the chassis and original track bar mount.

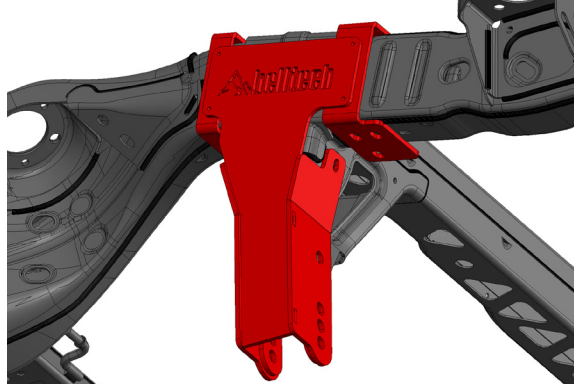

61. Insert the supplied M16 bolt, from front to back through the new bracket and the original frame side track bar hole. Ensure the steel crush tube is on the bolt side and only use a washer on the nut side. The nut should be on the back side of the bracket facing the rear of the vehicle. Fasten but do not torque yet.



## Technician reminder:

Failure to install the bolt in the correct orientation will cause the axle to come into contact with the bolt and can damage the brake line.



62. Insert the two supplied M12 bolts with nuts and washers through the front and back holes near the base of the bracket.

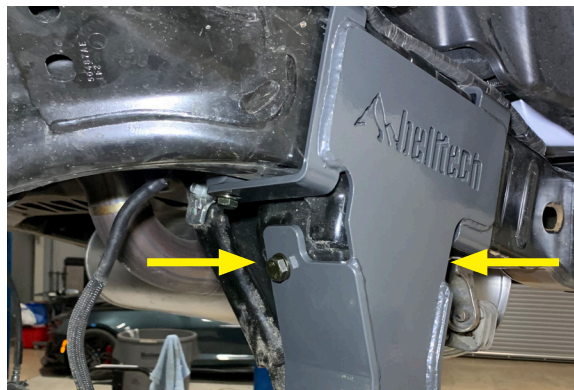

## REAR SUSPENSION INSTALLATION CONTINUED

63. With the remaining hardware, install the inner frame support (crush) plates. Support plate 2 is attached to the front side of the bracket and support plate 1 is attached to the rear side of the bracket.



64. Attach the original exhaust hanger bracket to the chassis with the original hardware.
65. Torque all M16 bolts to 220 ft lbs. and torque all M12 bolts to 100 ft lbs.
66. With the Belltech track bar set to length suggested on page 13, install the bar with the adjustable rod end on the axle side and the bushing side on the track bar bracket. Place the bolt head in hex cut out on the front side of the bracket.

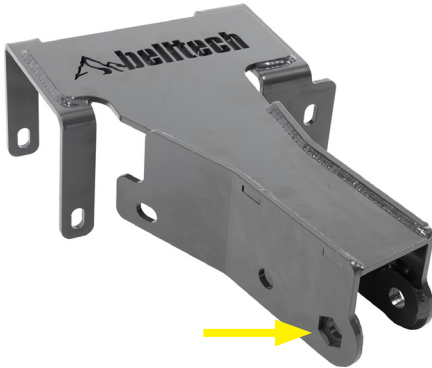

67. Detach the brake line bracket from the top of the axle on the passenger side.
68. Install the Belltech brake line extension bracket to the axle using the original bolt then attach the original bracket to the extension with the supplied M8 hardware.

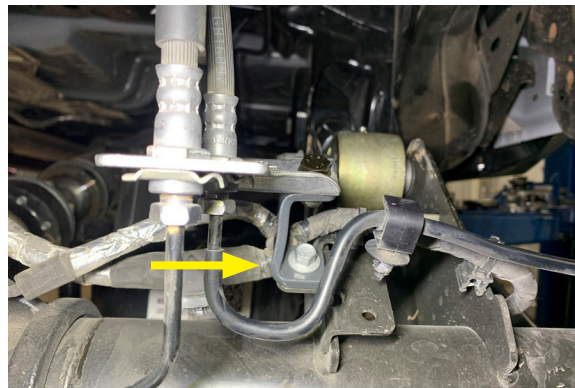

# REAR SUSPENSION INSTALLATION CONTINUED



## Technician note:

**WARNING:** Use caution when working around an open fuel source. No smoking, grinding, etc. It is highly recommended to temporarily cover or plug the opening on the fuel tank.

69. Loosen the hose clamp and disconnect the large fuel filler hose from fuel tank.



70. Support fuel tank as evenly as possible with a jack or transmission jack.
71. Remove all bolts securing the fuel tank to the chassis. Some models will have bolt-on straps holding the tank and some models will have a large skid plate holding the tank.
72. Carefully lower the tank 3-5 inches. Ensure not to stretch any hoses or wires. If necessary, unplug the wire harness. There is a vent hose that runs the length of the top of the tank. This hose does not need to be disconnected, but will need to be unclipped from the top of the tank to allow the tank to drop more.
73. Lower the tank more, about 6-8 inches in total for access to both passenger control arm bolts.



74. Remove the protective covers on passenger control arm bolts.



## REAR REMOVAL/INSTALL

75. Break loose but do not remove all 8 control arm bolts. All original hardware will be used to install the new Belltech control arms.
76. Ensure the axle is fully supported and will not rotate when the control arms are removed. Working in pairs (both upper arms, then both lower arms) replace all the factory control arms with the new Belltech adjustable length control arms. The adjustable rod ends will be installed on the axle side with the grease fitting pointing upward. Fasten but do not torque the bolts yet.

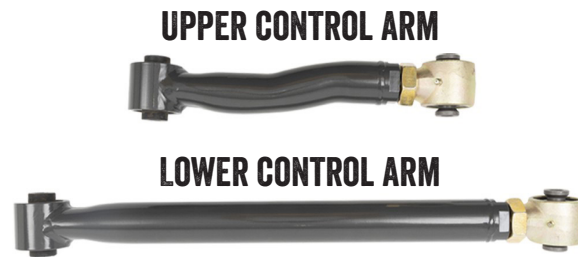

77. Using a floor jack, raise the axle until the hub to fender measurement matches the desired ride height (reference the “before” measurement recorded on page 2, plus your desired lift amount). Alternatively, set your rear upper control arms at a 9 degree angle, and/or your lower control arms to a 15 degree angle. Now torque all 8 control arm bolts to 159 ft lbs. Failure to tighten rubber bushings at ride height will cause stress and premature failure.



78. Install the control arm bolt covers, torque to 97 *in lbs*.
79. Raise fuel tank back into position. Reconnect any electrical connectors and clip vent lines back into place if removed.
80. Torque all fuel tank mounting bolts to factory specs and reconnect the fuel filler hose and clamp.
81. With the floor jack still under axle, raise the axle through its full travel. Ensure there is no contact between axle and roll center relocation bracket. If any contact occurs, adjust rear control arms as needed.
82. Depending on the kit that was ordered, reference the individual instructions now and install the spacer, strut, or coilover set that was included with your kit and install the struts or coilovers to the frame and axle.
83. Check the clearance between the passenger upper control arm bolt cover and fuel tank skid plate. If any contact occurs, bend or trim the back edge of the skid plate as needed. If cutting the plate, ensure all fuel hoses are secure to prevent sparks from igniting fuel vapors.
84. Attach the fender liner and secure it with the original fasteners.



### Technician note:

Depending on the kit that was ordered, your rear suspension will include spacers, struts, or coilovers. This set will have its own instructions, which you can reference for installation.

If the kit you purchased includes a Belltech anti-sway bar kit, please reference the instructions to install your rear sway bar after installing the rear Belltech suspension.

# FINALIZING THE INSTALLATION

85. Re-install the wheels and tighten the lug nuts.
86. Lift the vehicle and remove the support stands.
87. Carefully lower the vehicle onto the flat ground.
88. Torque the lug nuts to 100 ft lbs.
89. Check that all components and fasteners have been properly installed and torqued.
90. Re-read and perform all tasks in the “Before Driving Your Vehicle” section of page 1 of your instructions.

## THANK YOU FOR CHOOSING BELLTECH.

You are now a part of the Belltech family and we are eager to catch a glimpse of your newly modified vehicle. Give us a shout out and let us know how much you love our product. Don't forget, we offer other Belltech related merchandise for you and your vehicle on our website [www.belltech.com](http://www.belltech.com)

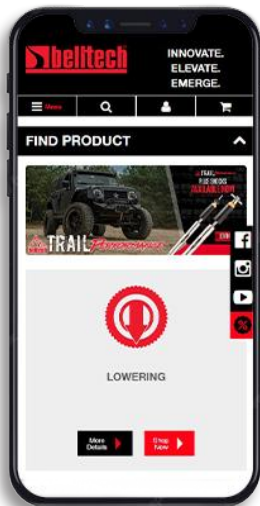

belltechsuspension



Belltech Suspension



@belltechsuspension

If you have any questions, concerns, or warranty related issues regarding your Belltech product, please call or email our experienced customer service specialists.

### Belltech Customer Support:

Phone: 1-800-445-3767

Email: [info@belltech.com](mailto:info@belltech.com)

# KIT CONTENTS

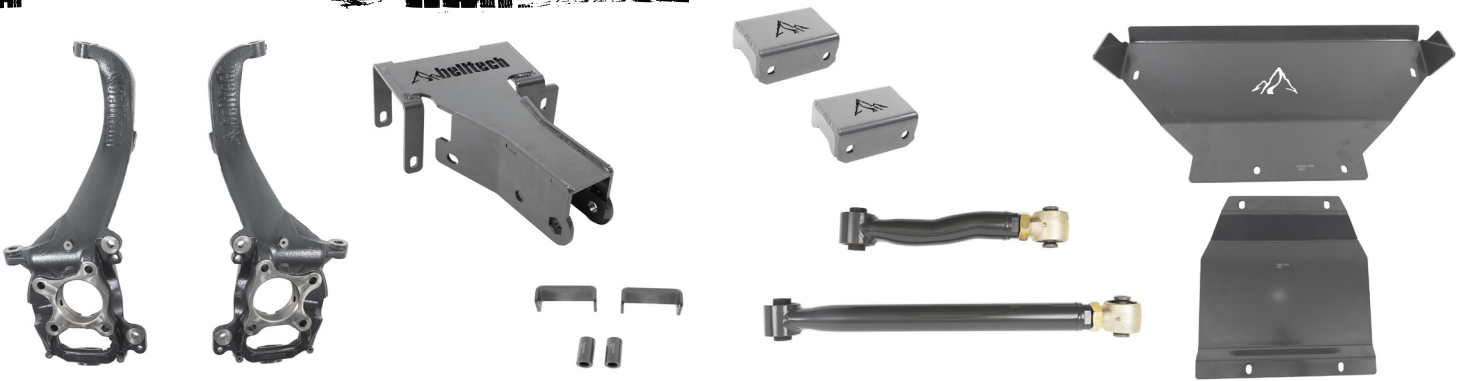

LK2021		
Part number	Description	Qty
152600-103R-982	LIFT SPINDLE RH	1
152600-103L-982	LIFT SPINDLE LH	1

LK20006 (REAR COMPONENT KIT A)		
Part number	Description	Qty
152600-211	REAR ADJ UPPER CONTROL ARM	2
152600-212	REAR ADJ LOWER CONTROL ARM	2
152600-215	REAR ADJ TRACK BAR	1

LK20004		
Part number	Description	Qty
152600-101-992	FRONT CROSS MEMBER	1
152600-102-992	REAR CROSS MEMBER	1
152600-104L-992	DIFFERENTIAL DROP LH	1
152600-113-992	SWAY BAR DROP DOWN	2
LK20008	SUB KIT A	1

LK20007 (REAR COMPONENT KIT B)		
Part number	Description	Qty
152600-200A-992	REAR ROLL CENTER CORR BRKT	1
152600-200B-992	RCC BRKT CRUSH TUBE	1
152600-200C-992	RCC BRKT CRUSH PLATE 1	1
152600-200D-992	RCC BRKT CRUSH PLATE 2	1
152600-226-992	REAR BRAKE LINE BRKT	1
152600E-777	HARDWARE KIT	1
152600I-777	HARDWARE KIT	1

LK20008 (SUB KIT A)		
Part number	Description	Qty
152600-128-992	FRONT BRAKE LINE BRKT	2
152600-140-966	DRIVE LINE SPACER	2
152600A-777	HARDWARE KIT	1
152600B-777	HARDWARE KIT	1
152600C-777	HARDWARE KIT	1
152600F-777	HARDWARE KIT	1
152600G-777	HARDWARE KIT	1
152600H-777	HARDWARE KIT	1
152600J-777	HARDWARE KIT	1

LK20005		
Part number	Description	Qty
152600-108A-992	MAIN SKID PLATE	1
152600-108B-992	FRONT SKID PLATE	1
152600D-777	HARDWARE KIT	1

# KIT CONTENTS

152600A-777 Hardware Kit		
Part number	Description	Qty
110219	M16 WASHER	6
110242	M16x2.0 LOCK NUT	3
112135	M16X2.0 BOLT	3

152600B-777 Hardware Kit		
Part number	Description	Qty
110219	M16 WASHER	4
110242	M16x2.0 LOCK NUT	2
112135	M16X2.0 BOLT	2

152600C-777 Hardware Kit		
Part number	Description	Qty
110225	BOLT M12 x 1.75 - 30MM	4
110228	WASHER FLAT M12	8
112165	NUT NYLOC M12 X 1.75	4

152600D-777 Hardware Kit		
Part number	Description	Qty
112142	FLANGE BOLT M10 X 1.5	4

152600E-777 Hardware Kit		
Part number	Description	Qty
110239	WASHER FLAT M10	10
110244	NUT (NYLOC) M10-1.25	5
112135	BOLT M16 X 2.0 - 115MM	2
110219	WASHER FLAT M16	2
110242	NUT NYLOC M16 X 2.0	2
110298	BOLT M10x1.25 – 30MM	5
110225	BOLT M12 x 1.75 - 30MM	1
112165	NUT NYLOC M12 X 1.75	1
110228	WASHER FLAT M12	2

152600F-777 Hardware Kit		
Part number	Description	Qty
110291	BOLT M12X1.75-75MM	2
110228	WASHER FLAT M12	4
112165	NUT NYLOC M12 X 1.75	2
110222	NUT NYLOC M14 X 2.0	2
110223	WASHER FLAT M14	4
110296	BOLT M14x2.0 – 60MM CL10.9	2

152600G-777 Hardware Kit		
Part number	Description	Qty
110239	WASHER FLAT M10	2
110238	NUT NYLOC M10 X 1.50	1
110297	BOLT M10x1.5 – 75MM	1

152600H-777 Hardware Kit		
Part number	Description	Qty
110232	BOLT M8 x 1.00 - 16MM	2
110245	WASHER FLAT M8	4
110233	NUT NYLOC M8 X 1.00	2
112011	FLANGE BOLT M8 X 1.25	2
112147	FLANGE NUT M8X1.25	2

152600I-777 Hardware Kit		
Part number	Description	Qty
112011	FLANGE BOLT M8 X 1.25	1
112147	FLANGE NUT M8X1.25	1

152600J-777 Hardware Kit		
Part number	Description	Qty
112199	BOLT M8X1.25-70MM	6