



PMR 207BT

Manual

GB

Introduction:

Thanks for choosing our *Bluetooth* transmitter (TX) & receiver (RX) audio adapter. This device combines the function of wireless transmitter and receiver in one for audio streaming. In the Transmitting (TX) Mode, It streams audio wirelessly from the non- *Bluetooth* devices to your *Bluetooth* headphone or speakers. In the Receiving (RX) Mode, it streams audio to your wired speaker, headphone, car stereo or home stereo system wirelessly, from your *Bluetooth*-enabled media player. If you want to have a better experience, please read this instruction carefully.

Packing Contents:

- Bluetooth Tx & Rx audio adapter
- Male to male 3.5mm Aux cable
- Micro USB charging cable
- User Guide

Features:

1. Advanced *Bluetooth* Technology 4.2 with Transmitter and Receiver.
2. Broadcast Audio Output from Your TV, CD player, or Old PC to Wireless Headphones, Speakers and Even Car Stereo System.
3. Low Latency and instant sound transmission, enables user to enjoy high-quality audio and HD picture synchronously.
4. Supreme Audio Connectivity and Quality with improved connection stability, faster pairing, and reduced power consumption for connected devices.
5. Switch operation and audio connection modes with the simple flick of a switch.
6. Effortlessly enjoying up to 10 hours of use on the larger internal battery and rapid recharging within 2 hours, ready for many more.
7. Suitable for In-car Usage as a Hands-free Car Kit.
8. Built-in Rechargeable Battery 450mAh, Standby time about 35 Hours.

Specifications:

Bluetooth Version: 4.2

Bluetooth ID: BT14

Bluetooth Distance: about 8m

TX Working time: 10 hours

RX Working time: 10 hours

Standby time: about 35 hours

Charging time: 2 hours

Power input: DC 5V/500mA

Product Size: 71*51*14.7mm

Microphone: ϕ 4.0*1.5mm/-43db

Audio Jack: 3.5mm Aux-in /Aux-out

Product weight: 50.7g

Compatibility:

This device can be paired as a hands-free kit with any compatible *Bluetooth* enabled devices. Each time can only be connected with one *Bluetooth* device.

Precautions:

Please read all safety instruction warnings carefully before using this product. Improper use of this product may result in damage to this or attached products. To ensure the products work well, please never use this in the following conditions:

1. Moist or underwater conditions.
2. Conditions near heater or high-temperature service.
3. Conditions with direct and strong sunshine,
4. Conditions with apt falling
5. Never dismantle the product without due permission, otherwise it may nullify the warranty clause.

Appearance:

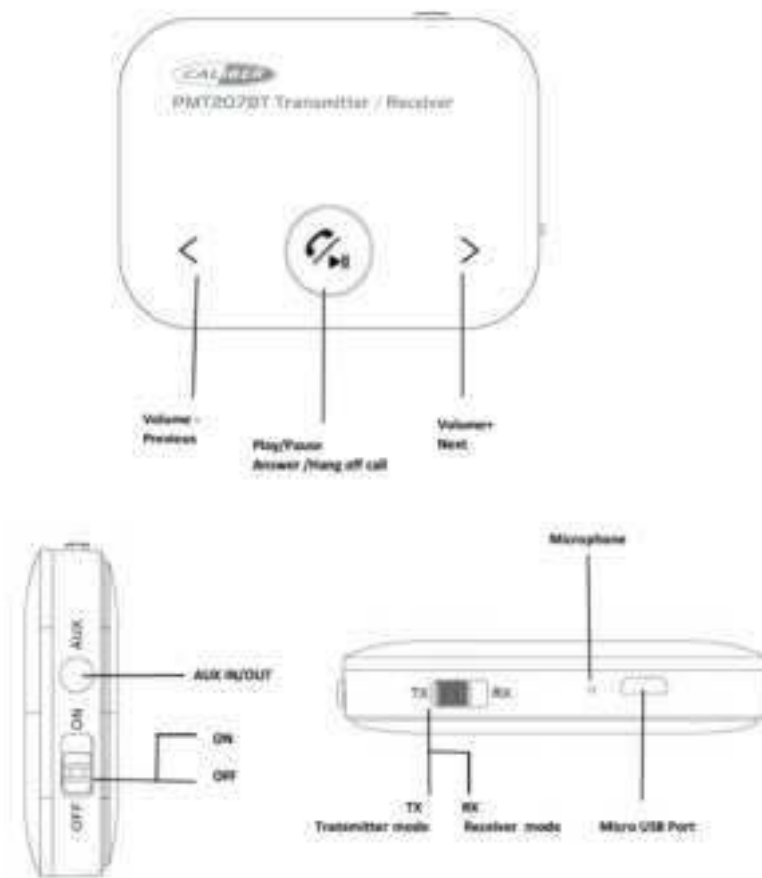

Operation Instructions

How to use the device:

1. Switch to "ON" or "OFF" to power on or power off the device.
2. Switch to "TX" (Transmitting mode), the product will search the available *Bluetooth* devices automatically and the led light will be flickering in white, when it success paired with the *Bluetooth* devices the led light will keep in white. When switch to "RX" (Receiving mode), the led light will be flickering in blue, when it pair with the *Bluetooth* devices the led light will keep in blue .
3. The product will search the available *Bluetooth* devices automatically. If it can't pair the *Bluetooth* devices in a long time, please press  to re-search the *Bluetooth* devices and reconnect.
4. The product will be power off automatically if there is no *Bluetooth* devices can be paired in 10 minutes, please slide the "ON /OFF" switch to reopen the adapter.

Conditions Mode	<i>Bluetooth</i> unpaired	<i>Bluetooth</i> paired	Handsfree function	Audio Jack
Rx Mode	LED flash in blue	LED light in blue	Available	Aux-out
Tx Mode	LED flash in white	LED light in white	Unavailable	Aux-in



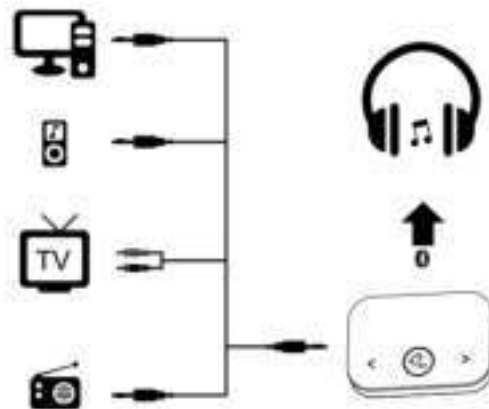

In the Transmitting(TX) mode :

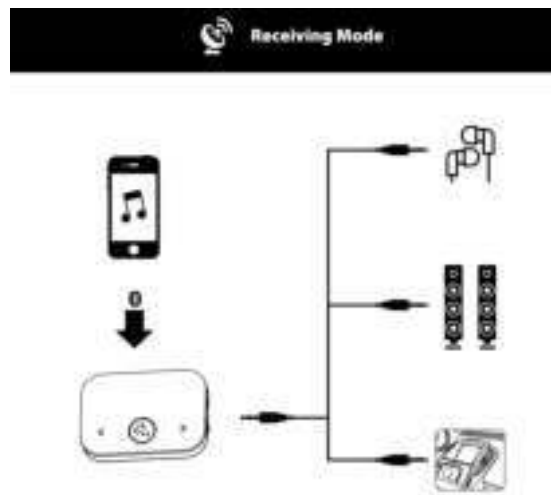

1. When the adapter was paired with the *Bluetooth* devices, the LED will keep light in white.
2. Long Press "<" to decrease the Volume, and long Press ">" to increase the Volume.

In the Receiving(RX) mode :







1. When the adapter pair the *Bluetooth* devices, the LED will keep light in blue.
2. Please short press “<” to play the previous song, and short press “>” to play the next song.
3. Please long press “<” to decrease the Volume, and long press “>” to increase the Volume.
4. Please short press  to play/pause music.
5. Please short press  to answer the incoming call in *Bluetooth* calling mode.
6. Please short press  to hang off a call in *Bluetooth* calling mode.
7. Please press  and hold for 2 seconds during call to reject the incoming call in *Bluetooth* calling mode.
8. Double press  to dial the last number automatically

Charging the *Bluetooth* Receiver

1. When the battery power is low the relative prompt will appear .
2. The LED light will keep in red when the device is in charging , the red LED light will be turn off when the charging is finished.

Quick Guide:

Power on	Switch to "ON"
Power off	Switch to "OFF"
Transmitter mode	Switch to "TX"
Receiver mode	Switch to "RX"
Connect devices	Press  once to search available <i>Bluetooth</i> devices
Play/Pause music	Press  once during music playing
Answer call	Press  once when there is incoming call
End call	Press  once during call
Ignore call	Press  and hold for 2 seconds during call, release when the beep is heard
Adjust the Volume	Press "<" or ">" and hold for 2 seconds to decrease or increase the volume in RX & TX mode .
Choose music	Press "<" or ">" to play the previous or next song in the RX mode.