

DacMagic 200M

Manual Generated: 24/05/2021 - 11:38

Table of Contents

DacMagic 200M	2
Front panel controls	3
Rear panel connections	4
Audio output connections	5
Digital audio input connections	7
USB connections	9
Master Quality Authenticated (MQA)	10
Bluetooth	11
Auto Power Down (APD)	12
Advanced settings	13
Technical specifications	14
Troubleshooting	16

DacMagic 200M

Last updated: February 22, 2021 04:34. Revision #1032
dacmagic 200m

This guide is designed to make installing and using this product as easy as possible. Information in this document has been carefully checked for accuracy at the time of printing; however, Cambridge Audio's policy is one of continuous improvement, therefore design and specifications are subject to change without prior notice.

This document contains proprietary information protected by copyright. All rights are reserved. No part of this manual may be reproduced by any mechanical, electronic or other means, in any form, without prior written permission of the manufacturer. All trademarks and registered trademarks are the property of their respective owners.

The Bluetooth® word mark and logos are registered trademarks owned by the Bluetooth SIG, Inc. and any use of such marks by Audio Partnership Plc is under license. Other trademarks and trade names are those of their respective owners.

MQA and the Sound Wave Device are registered trademarks of MQA Limited © 2016.

© Copyright Cambridge Audio Ltd .

Make sure you register your CA product:

WWW.CAMBRIDGEAUDIO.COM/REGISTER

For upcoming news on future products, software updates and exclusive offers.

Please check the support page at <https://techsupport.cambridgeaudio.com> for details of any new features, advice on compatibility with other products, audio formats and the most recent copy of this manual.

Front panel controls

Last updated: February 8, 2021 12:39. Revision #1033
dacmagic 200m / front panel controls

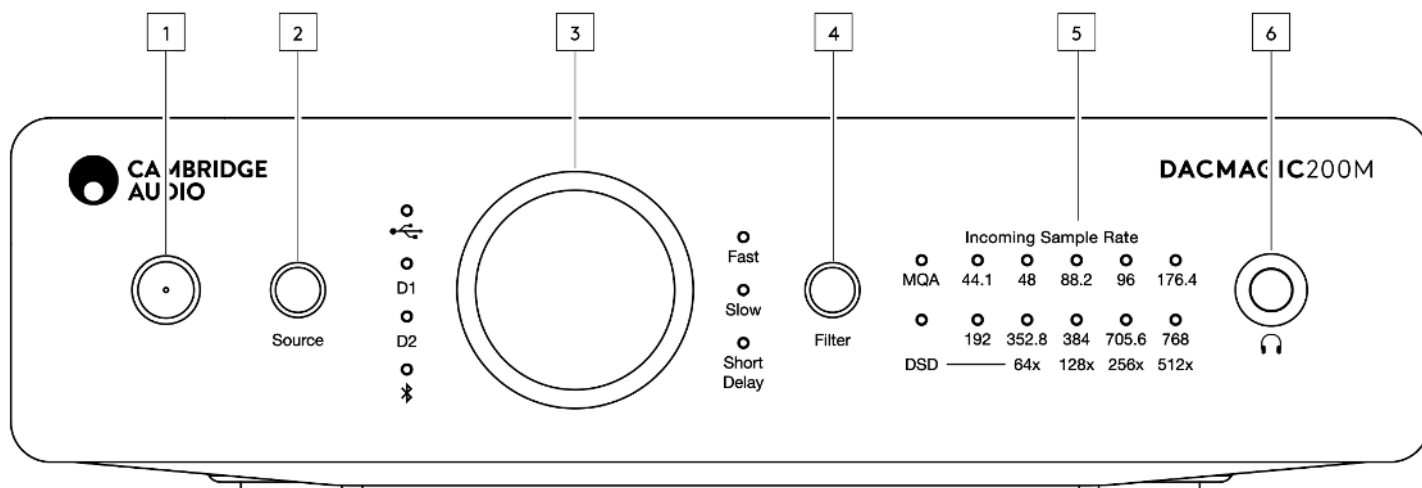

1. Standby/On

2. Source

Press to select between USB, Digital Inputs 1 and 2, and Bluetooth. The corresponding LED will light up to show which source has been selected.

3. Digital volume control

4. Filter

Press to select between three different filter modes: Fast, Slow or Short Delay, see later section for details. The corresponding LED will light up to show which filter has been selected.

5. Incoming sample rate

In the presence of an incoming digital stream, the relevant LED will light up to indicate the incoming digital sampling frequency. MQA has the following variants: Green means MQA, Blue means MQA studio. Magenta indicates that the unit is rendering an MQA stream or file. DSD will light up when native DSD or DoP streams are detected.

6. Headphone connection

Rear panel connections

Last updated: January 26, 2021 10:52. Revision #1034
dacmagic 200m / rear panel connections

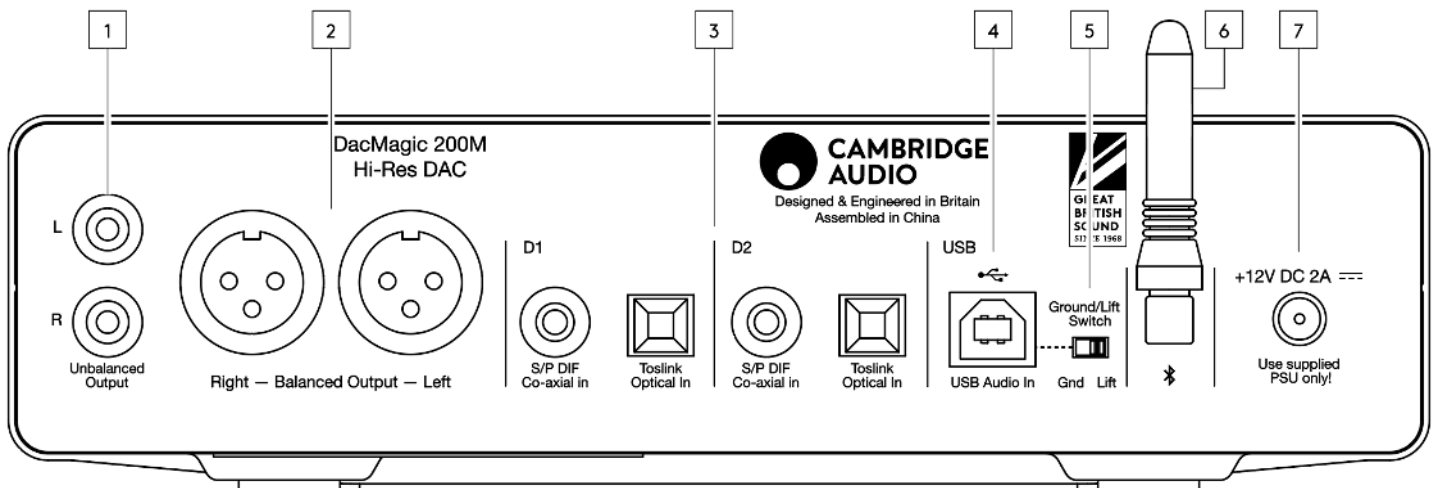

1. Unbalanced audio outputs

2. Balanced audio outputs

3. Digital inputs 1 and 2

4. USB Audio In

For connecting to PC/MAC computers.

Note: Class 2 USB Audio only. Windows-based PCs require a Cambridge Audio USB driver to be installed before connection.

5. Ground/Lift Switch

Ground - This is the default position if no issues are experienced with USB connection. USB host and DacMagic 200M use a common ground for highest link reliability.

Lift - Lifting the USB host ground can be useful if electronic hum is heard through the speakers. The switch should otherwise be left in the Ground position.

6. Bluetooth Antenna

Used for wireless streaming Bluetooth audio directly from most phones, tablets and laptops. See Bluetooth section for details.

7. DC 12V 2.0A power adaptor socket.

Audio output connections

Last updated: January 26, 2021 10:54. Revision #1035
dacmagic 200m / audio output connections

Note: Do not turn on the unit until all connections have been made.

You can use either the unbalanced (RCA/Phono) or balanced (XLR) outputs of the DacMagic.

Unbalanced connections

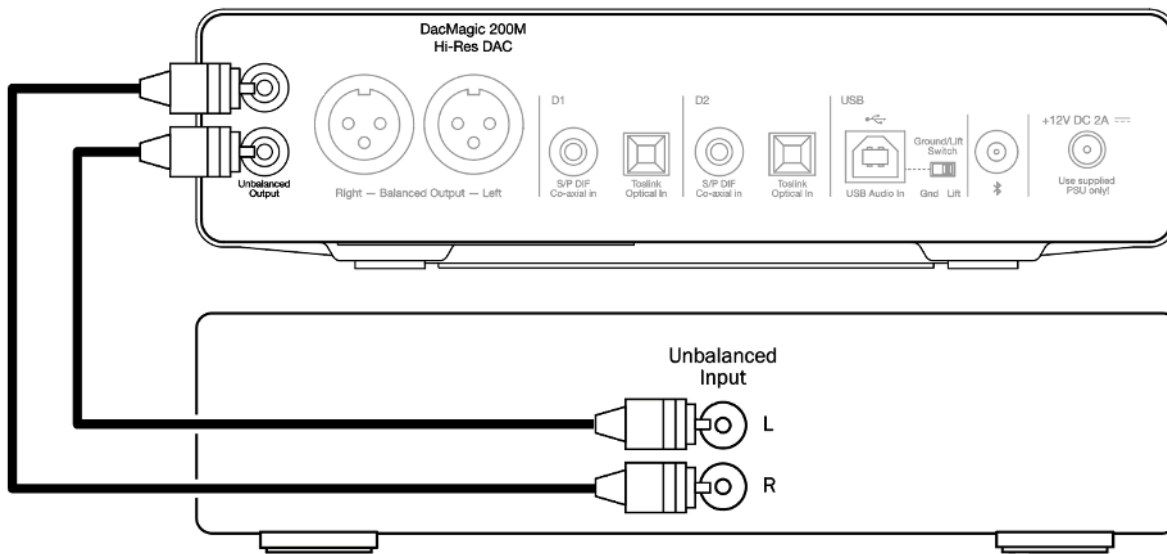

Balanced connections

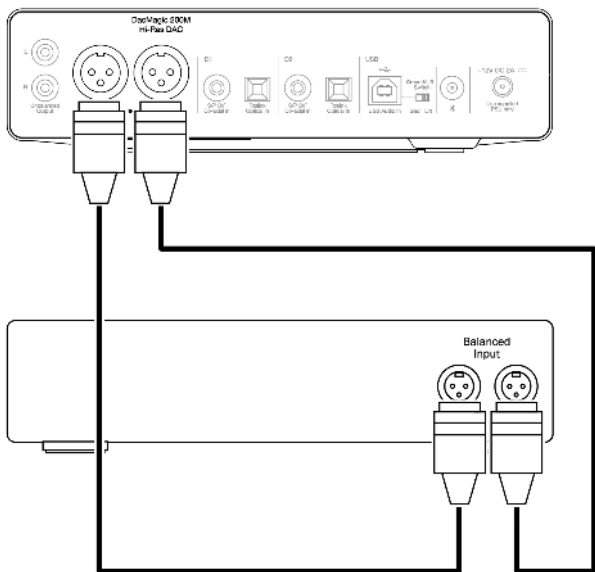

The XLR output is preferable for long connections if your amplifier features balanced XLR inputs. It can better reject noise and interference in the cable. It is possible to use the RCA phono connections and the XLR balanced connections at the same time, e.g. for connecting to different amplifiers or multi-room operations.

Digital audio input connections

Last updated: January 22, 2021 12:48. Revision #1036
 dacmagic 200m / digital audio input connections

Note: Do not turn on the unit until all connections have been made.

TOSLINK connection

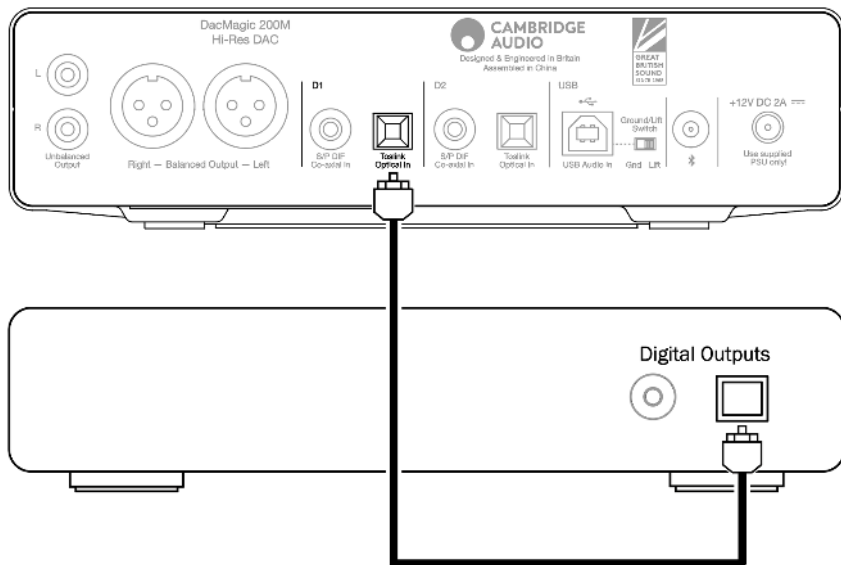

Co-axial connection

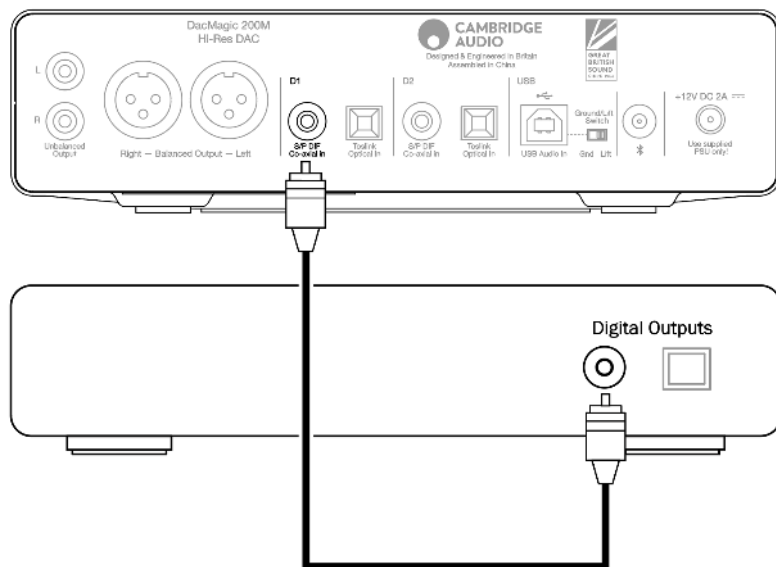

Connect your digital source to Digital Input 1 or 2. Either S/P DIF co-axial or TOSLINK optical types can be used. Optical is best to avoid ground loop noise, but some optical cables may not work correctly at 192kHz.

Important Note: Only connect one co-axial OR optical cable to each digital input. The unit will not operate if both connections are made (even if only one is active).

USB connections

Last updated: March 2, 2021 10:28. Revision #1057
dacmagic 200m / usb connections

Note: Do not turn on the unit until all connections have been made.

USB Connection

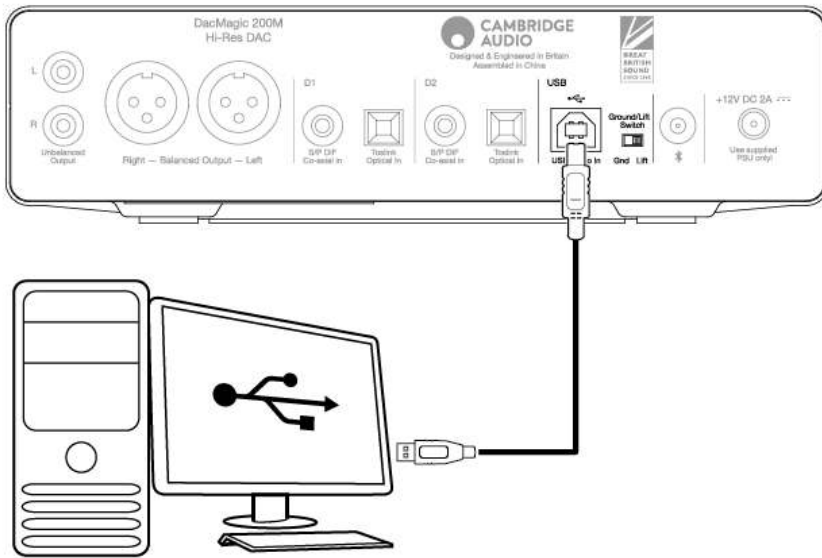

Class 2 USB Audio only. Windows based PCs require a Cambridge Audio USB driver to be installed before connection.

Note: Use a certified high-speed USB 2.0 'A-B' cable.

Master Quality Authenticated (MQA)

Last updated: February 23, 2021 10:44. Revision #1038
dacmagic 200m / master quality authenticated mqa

MQA is an award-winning British technology that delivers the sound of the original master recording. The master MQA file is fully authenticated and is small enough to stream or download.

Visit mqa.co.uk for more information.

DacMagic 200M includes MQA technology, which enables you to play back MQA audio files and streams, delivering the sound of the original master recording.

The MQA LED glows green or blue to indicate that the unit is decoding and playing an MQA stream or file, and denotes provenance to ensure that the sound is identical to that of the source material. It glows blue to indicate it is playing an MQA Studio file, which has either been approved in the studio by the artist/producer or has been verified by the copyright owner.

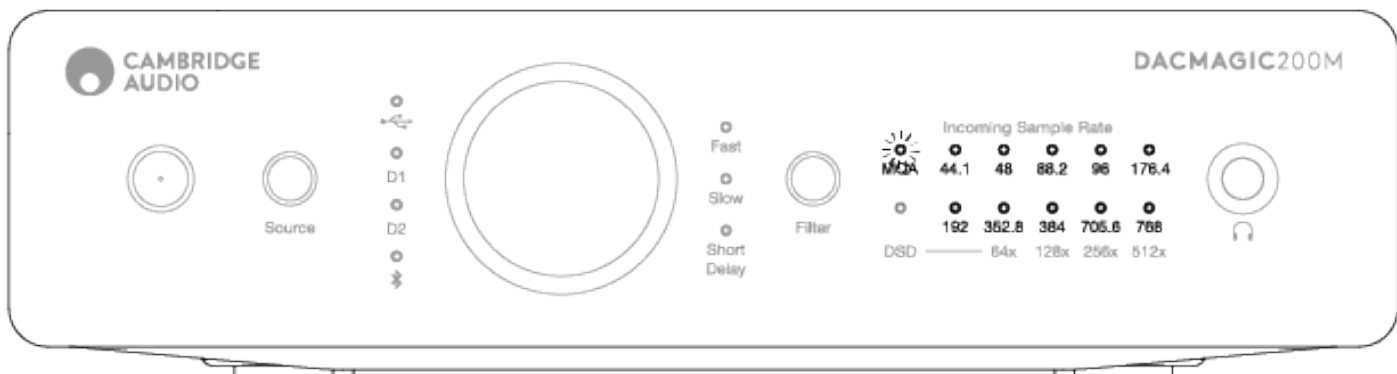

The MQA LED glows magenta to indicate that the unit is rendering an MQA stream or file. This delivers the final unfold of the MQA file.

Bluetooth

Last updated: March 9, 2021 04:54. Revision #1225
dacmagic 200m / bluetooth

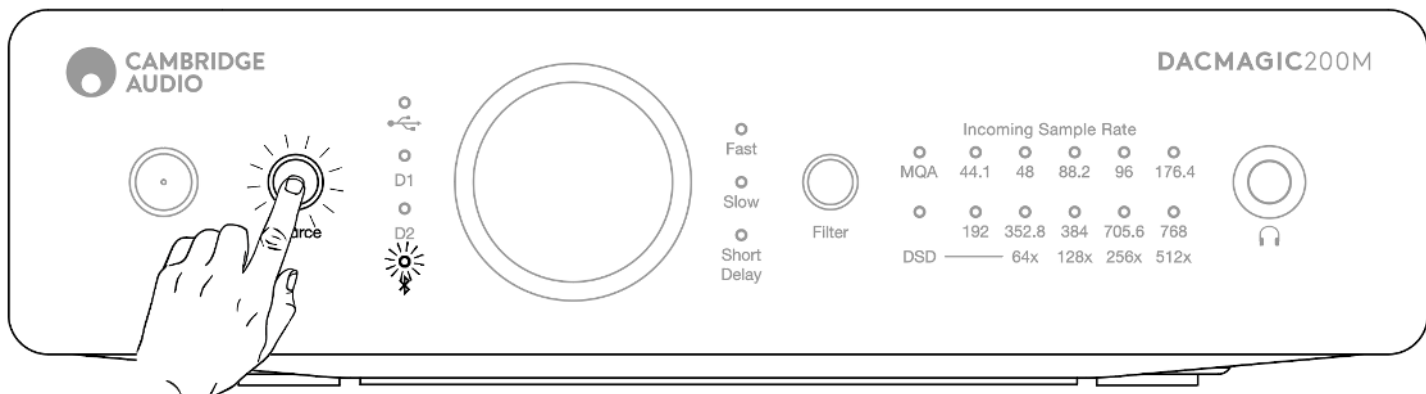

Selecting this allows the DacMagic 200M to receive wireless Bluetooth audio from most phones, tablets and laptops.

Pairing

To pair a new BT device with the DacMagic 200M you need to:

- Make sure any previously paired BT device is turned OFF (this product will auto-connect to the last paired device)
- Turn on Dac Magic 200M and select BT as a source
- Activate BT on the source device
- Scan for available devices on the source device and select 'DacMagic200M'

Unpairing

To unpair a device, you can select 'Unpair' in the phone's device list, or perform a factory reset on the DacMagic 200M, as this will delete all previously paired devices.

Note: Your device can only be paired and connected to the DacMagic 200M while the Bluetooth source is selected.

Paired LED status

Once your device is paired, below are the LED status of the type of codec that is being received.

SBC Codec is represented with a solid light.

aptX Codec is represented with a 2 seconds solid light followed by a very short light off interval.

Auto Power Down (APD)

Last updated: January 19, 2021 10:23. Revision #1040

dacmagic 200m / auto power down apd

The product will automatically switch to standby mode after inactivity of 20 minutes. To enable or disable this function, see below instruction:

Important note: Make sure that the DacMagic 200M is in the Standby state, before performing any APD functions.

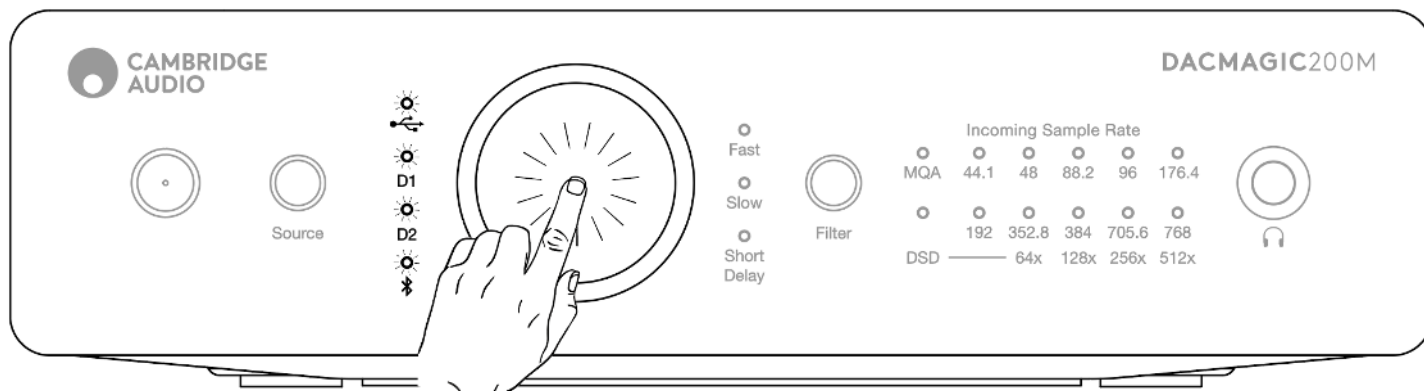

APD OFF - Press and hold down the Volume knob for 5 seconds, and wait for the Input LEDs to blink 2 times.

APD ON - Press and hold down the Volume knob for 10 seconds, and wait for the Input LEDs to blink 5 times.

Advanced settings

Last updated: February 8, 2021 01:05. Revision #1041

dacmagic 200m / advanced settings

Important note: Make sure that the DacMagic 200M is in the Standby state, before changing any settings.

Factory reset: All user-stored settings (input, volume and output mode) will be erased and replaced by the unit's default settings.

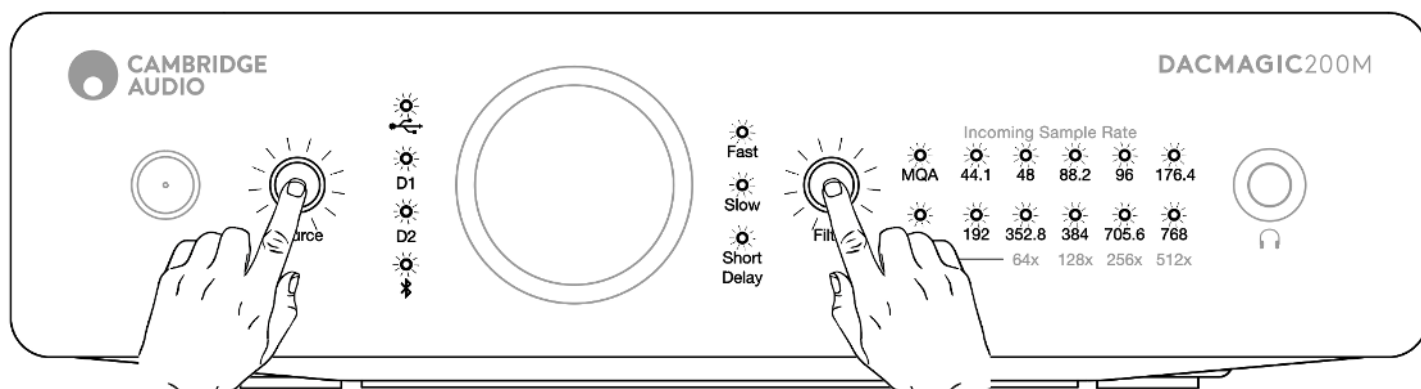

Short press both Source and Filter buttons. All LEDs will light in sequence, one by one.

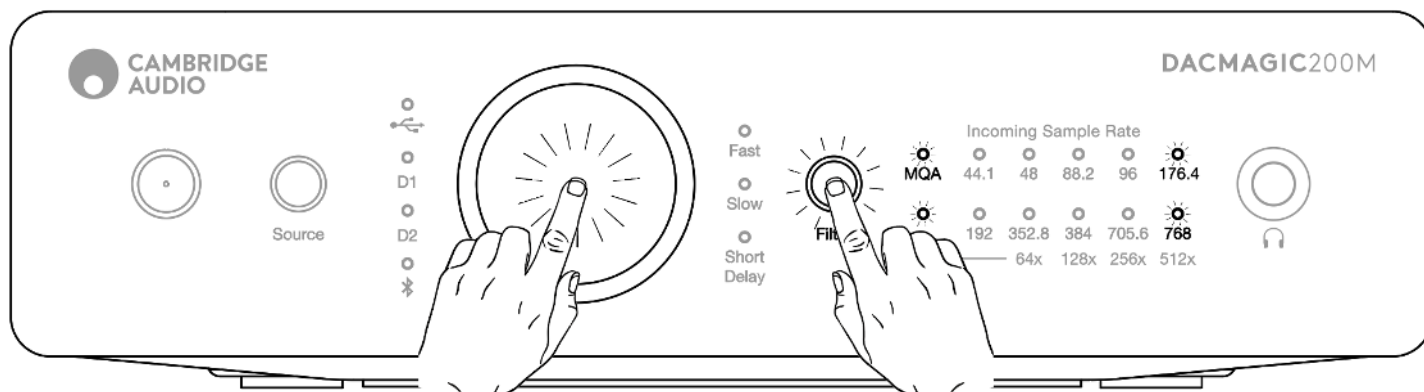

Fixed/variable out mode is toggled by short pressing the Volume knob and the Filter button at the same time:

RCA/XLR output set to fixed mode - MQA/DSD light up for 5s.

RCA/XLR output set to variable mode - 176.4/768 LED's light up for 5s.

Note: Headphone output is always variable.

Check MCU SOFTWARE version: Double press Source button first and then double press the Filter button.

For example, if the MCU version is V2.1, then the front panel LED should be showing:

MQA LED - Blink 2 times

44.1k LED - Blink 1 time

Technical specifications

Last updated: January 20, 2021 02:13. Revision #1042
dacmagic 200m / technical specifications

DIGITAL TO ANALOGUE CONVERTERS

Dual ESS ES9028Q2M DACs

DIGITAL FILTER

Selectable, Fast - Slow - Short delay

FREQUENCY RESPONSE

10Hz to 50KHz (± 1 dB)

THD+N @ 1KHZ 0DBFS

<0.0005% (A-Weighted)

SIGNAL TO NOISE RATIO

>115dB (A-Weighted)

CROSSTALK @ 10KHZ

< -110dB

OUTPUT IMPEDANCE

<50 Ohms (unbal), <100 Ohm (bal)

MAX. OUTPUT LEVEL (UNBALANCED)

2.1V rms (fixed or variable - user selectable)

MAX. OUTPUT LEVEL (BALANCED)

4.2V rms (fixed or variable - user selectable)

DIGITAL INPUT WORD WIDTHS SUPPORTED

16bit (Bluetooth)

16-24bit (Optical, Coaxial)

16-32bit (USB)

DIGITAL INPUT SAMPLING FREQUENCIES SUPPORTED

44.1kHz to 96kHz PCM, DoP64 (Optical)

44.1kHz to 192kHz PCM, DoP64 (Coaxial)

44.1kHz to 768kHz PCM, Native DSD 64x to 512x, DoP 64x to 256x (USB)

MQA COMPATIBILITY

Full decoding (Core + Renderer)

BLUETOOTH

v4.2, A2DP profile, SBC and AptX codecs

HEADPHONE OUTPUT

THD+N

< 0.001% at 1kHz 0dBFS @ 100mW into 32 Ohm

S/N

> 115dB (A-Weighted)

MAX OUTPUT POWER

>300mW @ 32 Ohm, >65mW @ 150 Ohm

FREQUENCY RESPONSE

10Hz - 50KHz (± 1 dB)

RECOMMEND HEADPHONE IMPEDANCE

10 Ohm to 600 Ohm

MAX POWER CONSUMPTION

12W

COLOUR

Lunar Gray

DIMENSIONS (HXWXD)

52 x 215 x 191mm; (2.0 x 8.6 x 7.6")

WEIGHT

1.2Kg/2.6lbs

Troubleshooting

Last updated: January 18, 2021 02:50. Revision #1043
dacmagic 200m / troubleshooting

There is no power

Ensure the supplied AC adaptor is connected securely to the PSU socket on the rear panel.

Ensure that the correct mains transformer is being used and that it complies with the local electrical supply.

Ensure the mains plug is fully inserted into the wall socket and is switched on.

There is no sound

Ensure that the amplifier is set correctly. Check that the interconnects are inserted correctly. Check that the correct digital input is selected (Incoming Sample Rate LED should be on).

A low hum or buzzing sound can be heard

Power cords or lighting placed near this product. Analogue inputs are not securely connected.

For USB try selecting the 'Lift' position by moving the Ground/Lift switch.