

# Canon

## EOS **REBEL T6**

## EOS **1300D**

EOS REBEL T6 (W)

EOS 1300D (W)



Camera

Wireless Function

### Basic Instruction Manual

Instruction manuals (PDF files) and software can be downloaded from the Canon Web site (p.4, 103).

[www.canon.com/icpd](http://www.canon.com/icpd)





# Canon

**EOS**  
***REBEL T6***

**EOS**  
**1300D**

**EOS REBEL T6 (W)**

**EOS 1300D (W)**

## Camera Basic Instruction Manual

The Camera Basic Instruction Manual covers the most basic operations and functions.

# Introduction

The EOS REBEL T6 (W) or EOS 1300D (W) is a digital single-lens reflex camera featuring a fine-detail CMOS sensor with approx. 18.0 effective megapixels, DIGIC 4+, high-precision and high-speed 9-point AF, approx. 3.0 fps continuous shooting, Live View shooting, Full High-Definition (Full HD) movie shooting, and wireless functions (Wi-Fi/NFC).

## **Before Starting to Shoot, Be Sure to Read the Following**

To avoid botched pictures and accidents, first read the “Safety Precautions” (p.13-15) and “Handling Precautions” (p.16-18). Also, read this manual carefully to ensure that you use the camera correctly.

## **Refer to This Manual while Using the Camera to Further Familiarize Yourself with the Camera**

While reading this manual, take a few test shots and see how they come out. You can then better understand the camera. Be sure to store this manual safely, too, so that you can refer to it again when necessary.

## **Testing the Camera Before Use and Liability**

After shooting, play images back and check whether they have been properly recorded. If the camera or memory card is faulty and the images cannot be recorded or downloaded to a computer, Canon cannot be held liable for any loss or inconvenience caused.

## **Copyrights**

Copyright laws in your country may prohibit the use of your recorded images or copyrighted music and images with music in the memory card for anything other than private enjoyment. Also be aware that certain public performances, exhibitions, etc., may prohibit photography even for private enjoyment.

## Item Check List

Before starting, check that all the following items are included with your camera. If anything is missing, contact your dealer.

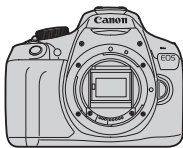

**Camera**

(with eyecup and body cap)



**Battery Pack LP-E10**  
(with protective cover)



**Battery Charger**  
**LC-E10/LC-E10E\***



**Strap**



**Interface Cable**

\* Battery Charger LC-E10 or LC-E10E is provided. (The LC-E10E comes with a power cord.)

- The Instruction Manuals provided are listed on the next page.
- If you purchased a Lens Kit, check that the lenses are included.
- Depending on the Lens Kit type, lens instruction manuals may also be included.
- Be careful not to lose any of the above items.



When you need Lens Instruction Manuals, download them from the Canon Web site (p.4).

The lens instruction manuals (PDF) are for lenses sold individually. Note that when purchasing the Lens Kit, some of the accessories included with the lens may not match those listed in the Lens Instruction Manual.

# Instruction Manuals



## Camera and Wireless Function Basic Instruction Manual

The booklet is the Basic Instruction Manual.

More detailed Instruction Manuals (PDF files) can be downloaded from the Canon Web site.

## Downloading and Viewing the Instruction Manuals (PDF Files)

### 1 Download the Instruction Manuals (PDF files).

- Connect to the Internet and access the following Canon Web site.  
**[www.canon.com/icpd](http://www.canon.com/icpd)**
- Select your country or region of residence and download the Instruction Manuals.

#### Instruction Manuals Available for Download

- Camera Instruction Manual
- Wireless Function Instruction Manual
- Camera and Wireless Function Basic Instruction Manual
- Lens Instruction Manuals
- Software Instruction Manuals

### 2 View the Instruction Manuals (PDF files).

- Double-click a downloaded Instruction Manual (PDF file) to open it.
- To view the Instruction Manuals (PDF files), Adobe Acrobat Reader DC or other Adobe PDF viewer (most recent version recommended) is required.
- Adobe Acrobat Reader DC can be downloaded free from the Internet.
- To learn how to use a PDF viewer, refer to its Help section.



Software can be downloaded from the Canon Web site (p.103).

## Compatible Cards

The following cards can be used with the camera regardless of capacity: **If the card is new or was previously formatted by another camera or computer, it is recommended that you format the card with this camera** (p.44).

- SD memory cards
- SDHC memory cards
- SDXC memory cards



The camera can use UHS-I cards, but since it is not compatible with the UHS-I standard, reading/writing speeds will be equivalent to SD Speed Class 10 at most.

### Cards that Can Record Movies

**When shooting movies, use a large-capacity SD card rated SD Speed Class 6 “CLASS 6” or higher.**

- If you use a slow-writing card when shooting movies, the movie may not be recorded properly. Also, if you play back a movie on a card with a slow reading speed, the movie may not play back properly.
- To check the card’s reading/writing speed, refer to the card manufacturer’s Web site.



In this manual, “card” refers to SD memory cards, SDHC memory cards, and SDXC memory cards.

**\* The camera does not come with a card for recording images/movies.** Please purchase it separately.

# Quick Start Guide

1

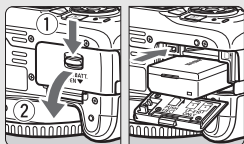

**Insert the battery** (p.28).

- To charge the battery, see page 26.

2

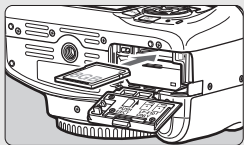

**Insert the card** (p.28).

- With the card's label facing toward the back of the camera, insert it into the card slot.

3

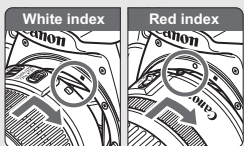

**Attach the lens** (p.36).

- Align the lens's white or red mount index with the camera's mount index of the same color.

4

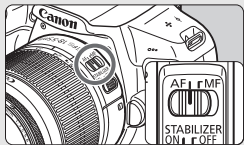

**Set the lens's focus mode switch to <AF>** (p.36).

5

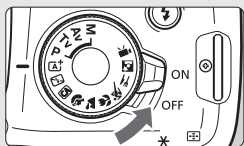

**Set the power switch to <ON>** (p.31).

- When the LCD monitor displays the date/time/zone setting screens, see page 33.

6

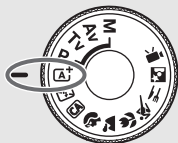

### Set the Mode Dial to **<AI+>** (Scene Intelligent Auto) (p.50).

- All the necessary camera settings will be set automatically.

7



### Focus on the subject (p.39).

- Look through the viewfinder and aim the viewfinder center over the subject.
- Press the shutter button halfway, and the camera will focus on the subject.
- If necessary, the built-in flash will be raised.

8

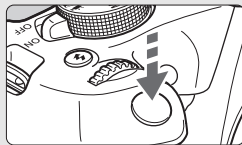

### Take the picture (p.39).

- Press the shutter button completely to take the picture.

9



### Review the picture.

- The captured image will be displayed for approx. 2 sec. on the LCD monitor.
- To display the image again, press the **<▶>** button (p.68).

- To shoot while looking at the LCD monitor, see “Live View Shooting” (p.69).
- To view the images captured so far, see “Image Playback” (p.68).
- To delete an image, see “Erasing Images” (p.98).

# Conventions Used in this Manual

## Icons in this Manual



: Indicates the Main Dial.



: Indicates the <↕> cross keys on the top, bottom, left, and right.



: Indicates the Setting button.

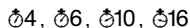

: Indicates that each function remains active for approx. 4 sec., 6 sec., 10 sec., or 16 sec. after you let go of the button.

\* In addition to the above, the icons and symbols used on the camera's buttons and displayed on the LCD monitor are also used in this manual when discussing relevant operations and functionality.



: Indicates a function that can be changed by pressing the <MENU> button to change its settings.



: When shown on the upper right of a page, it indicates that the function is available only in the Creative Zone modes (p.23).



: Reference page numbers for more information.



: Warning to prevent shooting problems.



: Supplemental information.



: Tips or advice for better shooting.



: Troubleshooting advice.

## Basic Assumptions

- All operations explained in this manual assume that the power switch is set to <ON> (p.31).
- It is assumed that all the menu settings and Custom Functions are set to their defaults.
- The illustrations in this manual show the camera attached with the EF-S18-55mm f/3.5-5.6 IS II lens as an example.

# Chapters

	<b>Introduction</b>	<b>2</b>
<b>1</b>	<b>Getting Started</b>	<b>25</b>
<b>2</b>	<b>Basic Shooting and Image Playback</b>	<b>49</b>
<b>3</b>	<b>Shooting with the LCD Monitor (Live View Shooting)</b>	<b>69</b>
<b>4</b>	<b>Shooting Movies</b>	<b>83</b>
<b>5</b>	<b>Image Playback</b>	<b>93</b>
<b>6</b>	<b>Software Start Guide / Downloading Images to a Computer</b>	<b>101</b>

# Contents













## **Introduction** **2**

Item Check List.....	3
Instruction Manuals .....	4
Compatible Cards.....	5
Quick Start Guide .....	6
Conventions Used in this Manual.....	8
Chapters.....	9
Safety Precautions .....	13
Handling Precautions .....	16
Nomenclature .....	19

## **1 Getting Started** **25**

Charging the Battery .....	26
Installing and Removing the Battery and Card .....	28
Turning on the Power .....	31
Setting the Date, Time, and Zone.....	33
Selecting the Interface Language.....	35
Attaching and Detaching a Lens.....	36
Basic Operation.....	38
<b>Q</b> Quick Control for Shooting Functions.....	40
<b>MENU</b> Menu Operations.....	42
Formatting the Card .....	44
Switching the LCD Monitor Display .....	46
Feature Guide .....	47

**2 Basic Shooting and Image Playback 49**

 Fully Automatic Shooting (Scene Intelligent Auto) .....	50
 Full Auto Techniques (Scene Intelligent Auto).....	53
 Disabling Flash .....	55
 Creative Auto Shooting.....	56
 Shooting Portraits .....	59
 Shooting Landscapes .....	60
 Shooting Close-ups.....	61
 Shooting Moving Subjects .....	62
 Shooting Food .....	63
 Shooting Night Portraits .....	64
 Quick Control.....	66
 Image Playback .....	68





**3 Shooting with the LCD Monitor (Live View Shooting) 69**

 Shooting with the LCD Monitor .....	70
Using AF to Focus (AF Method) .....	73

**4 Shooting Movies 83**

 Shooting Movies .....	84
Autoexposure Shooting .....	84
Setting the Movie Recording Size .....	89

**5 Image Playback 93**

 Searching for Images Quickly .....	94
 Magnified View .....	95
 Playing Back Movies.....	96
 Erasing Images .....	98
DISP. Shooting Information Display .....	99

<b>6</b>	<b>Software Start Guide / Downloading Images to a Computer</b>	<b>101</b>
	Software Start Guide .....	102
	Downloading and Viewing the Software Instruction Manuals (PDF Files) .....	104
	Downloading Images to a Computer .....	105
	Index.....	111

 For Troubleshooting guide and Specifications, refer to the Instruction Manual downloadable from the Canon Web site. For how to download the Instruction Manual, see page 4.

 **Certification Logo**  
Under the [**F3**] tab, if you select [**Certification Logo Display**] and press <[**SET**]>, some of the logos of the camera's certifications will appear. Other certification logos can be found in this Instruction Manual, on the camera body, and on the camera's package.

# Safety Precautions

The following precautions are provided to prevent harm or injury to yourself and others. Make sure to thoroughly understand and follow these precautions before using the product.

**If you experience any malfunctions, problems, or damage to the product, contact the nearest Canon Service Center or the dealer from whom you purchased the product.**



**Warnings:** Follow the warnings below. Otherwise, death or serious injuries may result.

- To prevent fire, excessive heat, chemical leakage, explosions, and electrical shock, follow the safeguards below:
  - Do not use any batteries, power sources, or accessories not specified in the Instruction Manual. Do not use any home-made or modified batteries, or the product if it is damaged.
  - Do not short-circuit, disassemble, or modify the battery. Do not apply heat or solder to the battery. Do not expose the battery to fire or water. Do not subject the battery to strong physical shock.
  - Do not insert the battery's plus and minus ends incorrectly.
  - Do not recharge the battery in temperatures outside the allowable charging (working) temperature range. Also, do not exceed the recharge time indicated in the Instruction Manual.
  - Do not insert any foreign metallic objects into the electrical contacts of the camera, accessories, connecting cables, etc.
- When disposing of a battery, insulate the electrical contacts with tape. Contact with other metallic objects or batteries may cause a fire or an explosion.
- If excessive heat, smoke, or fumes are emitted when recharging the battery, immediately unplug the battery charger from the power outlet to stop recharging. Otherwise, it may cause a fire, heat damage, or electrical shock.
- If the battery leaks, changes color, deforms, or emits smoke or fumes, remove it immediately. Be careful not to get burned in the process. It may cause a fire, electrical shock or burns if you keep using it.
- Prevent any battery leakage from contacting your eyes, skin, and clothing. It can cause blindness or skin problems. If the battery leakage comes in contact with your eyes, skin, or clothing, flush the affected area with lots of clean water without rubbing it. See a physician immediately.
- Do not leave any cords near a heat source. It can deform the cord or melt the insulation and cause a fire or electrical shock.
- Do not hold the camera in the same position for long periods of time. Even if the camera does not feel too hot, prolonged contact with the same body part may cause skin redness or blistering due to low-temperature contact burns. Using a tripod is recommended for people with circulation problems or very sensitive skin, or when using the camera in very hot places.
- Do not fire the flash at anyone driving a car or other vehicle. It may cause an accident.

- When the camera or accessories are not in use, make sure to remove the battery, and disconnect the power plug and connecting cables from the equipment before storing. This is to prevent electrical shock, excessive heat, fire, and corrosion.
- Do not use the equipment where there is flammable gas. This is to prevent an explosion or a fire.
- If you drop the equipment and the casing breaks open to expose the internal parts, do not touch the exposed internal parts. There is a possibility of an electrical shock.
- Do not disassemble or modify the equipment. High-voltage internal parts can cause electrical shock.
- Do not look at the sun or an extremely bright light source through the camera or lens. Doing so may damage your vision.
- Keep equipment out of the reach of children and infants, including when in use. Straps or cords may accidentally cause choking, electrical shock, or injury. Choking or injury may also occur if a child or infant accidentally swallows a camera part or accessory.
- Do not use or store the equipment in dusty or humid places. Likewise, keep the battery away from metallic items and store it with its protective cover attached to prevent short-circuit. This is to prevent fire, excessive heat, electrical shock, and burns.
- Before using the camera inside an airplane or hospital, check if it is allowed. Electromagnetic waves emitted by the camera may interfere with the plane's instruments or the hospital's medical equipment.
- To prevent a fire and electrical shock, follow the safeguards below:
  - Always insert the power plug all the way in.
  - Do not handle a power plug with wet hands.
  - When unplugging a power plug, grasp and pull the plug instead of the cord.
  - Do not scratch, cut, or excessively bend the cord or put a heavy object on the cord. Also, do not twist or tie the cords.
  - Do not connect too many power plugs to the same power outlet.
  - Do not use a cord whose wire is broken or insulation is damaged.
- Unplug the power plug periodically and clean off the dust around the power outlet with a dry cloth. If the surrounding is dusty, humid, or oily, the dust on the power outlet may become moist and short-circuit the outlet, causing a fire.
- Do not connect the battery directly to an electrical outlet or a car's cigarette lighter outlet. The battery may leak, generate excessive heat or explode, causing fire, burns, or injuries.
- A thorough explanation of how to use the product by an adult is required when the product is used by children. Supervise children while they are using the product. Incorrect usage may result in electrical shock or injury.
- Do not leave a lens or lens-attached camera in the sun without the lens cap attached. Otherwise, the lens may concentrate the sun's rays and cause a fire.
- Do not cover or wrap the product with a cloth. Doing so may trap heat within and cause the casing to deform or catch fire.
- Be careful not to get the camera wet. If you drop the product in the water or if water or metal get inside the product, promptly remove the battery. This is to prevent fire, electrical shock, and burns.
- Do not use paint thinner, benzene, or other organic solvents to clean the product. Doing so may cause fire or a health hazard.



**Cautions:** Follow the cautions below. Otherwise, physical injury or property damage may result.

- Do not use or store the product in a high-temperature location such as inside a car under the hot sun. The product may become hot and cause burns. Doing so may also cause battery leakage or explosion, which will degrade the performance or shorten the life of the product.
- Do not carry the camera around when it is attached to a tripod. Doing so may cause an injury or an accident. Also make sure the tripod is sturdy enough to support the camera and lens.
- Do not leave the product in a low-temperature environment for an extended period of time. The product will become cold and may cause injury when touched.
- Do not fire the flash near the eyes. It may hurt the eyes.

# Handling Precautions

## Camera Care

- This camera is a precision instrument. Do not drop it or subject it to physical shock.
- The camera is not waterproof and cannot be used underwater. If you accidentally drop the camera into water, promptly consult the nearest Canon Service Center. Wipe off any water droplets with a dry and clean cloth. If the camera has been exposed to salty air, wipe it with a well-wrung wet cloth.
- Never leave the camera near anything having a strong magnetic field such as a magnet or electric motor. Also, avoid using or leaving the camera near anything emitting strong radio waves, such as a large antenna. Strong magnetic fields can cause camera misoperation or destroy image data.
- Do not leave the camera in excessive heat, such as in a car in direct sunlight.
- The camera contains precision electronic circuitry. Never attempt to disassemble the camera yourself.
- Do not block the built-in flash or mirror operation with your finger, etc. Doing so may cause a malfunction.
- Use only a commercially-available blower to blow away dust when it adheres to the lens, viewfinder, reflex mirror, focusing screen, etc. Do not use cleaners that contain organic solvents to clean the camera body or lens. For stubborn dirt, take the camera to the nearest Canon Service Center.
- Do not touch the camera's electrical contacts with your fingers. This is to prevent the contacts from corroding. Corroded contacts may cause camera misoperation.
- If the camera is suddenly brought in from the cold into a warm room, condensation may form on the camera and internal parts. To prevent condensation, first put the camera in a sealed plastic bag and let it adjust to the warmer temperature before taking it out of the bag.

- If condensation forms on the camera, do not use the camera. This is to avoid damaging the camera. If there is condensation, remove the lens, card and battery from the camera, and wait until condensation has evaporated before using the camera.
- If the camera will not be used for an extended period, remove the battery and store the camera in a cool, dry, well-ventilated location. Even while the camera is in storage, press the shutter button a few times once in a while to check that the camera is still working.
- Avoid storing the camera where there are chemicals that result in rust and corrosion such as in a chemical lab.
- If the camera has not been used for an extended period, test all its functions before using it. If you have not used the camera for some time or if there is an important shoot such as a foreign trip coming up, have the camera checked by your nearest Canon Service Center or check the camera yourself and make sure it is working properly.
- If you use continuous shooting, Live View shooting, or movie shooting for a prolonged period, the camera may become hot. This is not a malfunction.
- If there is a bright light source inside or outside the image area, ghosting may occur.

### **LCD Monitor**

- Although the LCD monitor is manufactured with very high precision technology with over 99.99% effective pixels, there may be a few dead pixels displaying only black or red, etc. among the remaining 0.01% or less pixels. Dead pixels are not a malfunction. They do not affect the images recorded.
- If the LCD monitor is left on for a prolonged period, screen burn-in may occur where you see remnants of what was displayed. However, this is only temporary and will disappear when the camera is left unused for a few days.
- The LCD monitor display may seem slow in low temperatures, or look black in high temperatures. It will return to normal at room temperature.

## Cards

To protect the card and its recorded data, note the following:

- Do not drop, bend, or wet the card. Do not subject it to excessive force, physical shock, or vibration.
- Do not touch the card's electronic contacts with your fingers or anything metallic.
- Do not affix any stickers, etc., on the card.
- Do not store or use the card near anything that has a strong magnetic field, such as a TV set, speakers, or magnets. Also avoid places prone to having static electricity.
- Do not leave the card in direct sunlight or near a heat source.
- Store the card in a case, etc.
- Do not store the card in hot, dusty, or humid locations.

## Lens

After detaching the lens from the camera, put down the lens with the rear end up and attach the rear lens cap to avoid scratching the lens surface and electrical contacts.

## Smudges Adhering to the Front of the Sensor

Besides dust entering the camera from outside, in rare cases lubricant from the camera's internal parts may adhere to the front of the sensor. If visible spots remain on the image, having the sensor cleaned by a Canon Service Center is recommended.



# Nomenclature

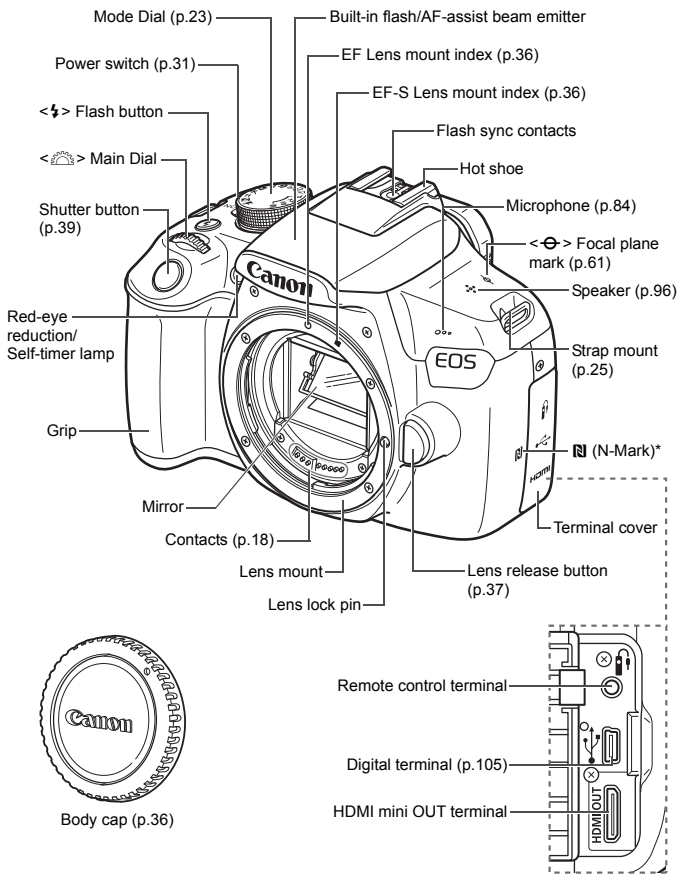

\* Used for wireless connections via the NFC function.

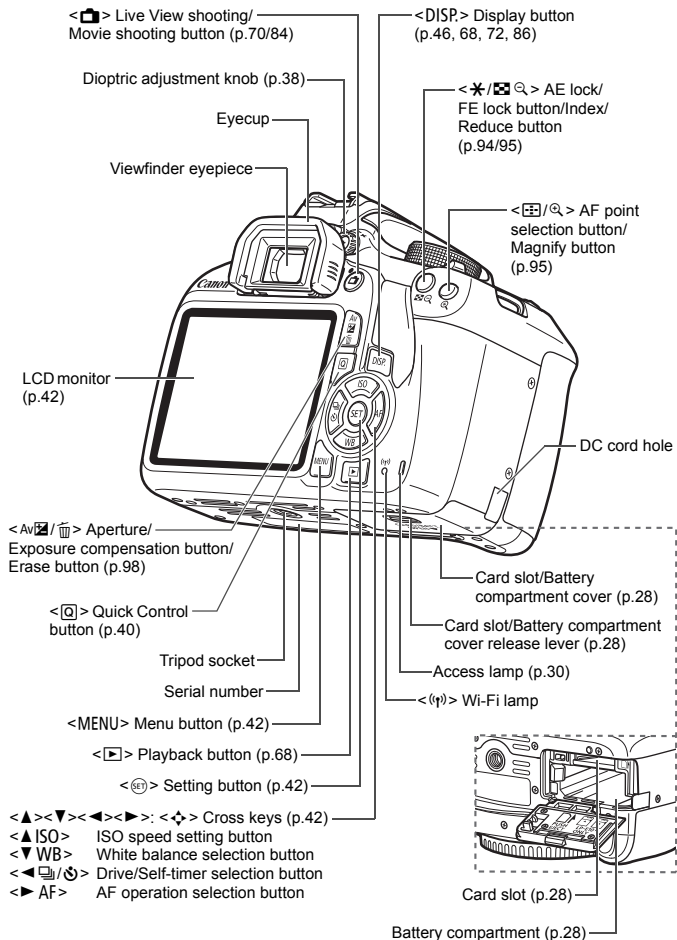

## Shooting Function Settings (in Creative Zone modes, p.23)

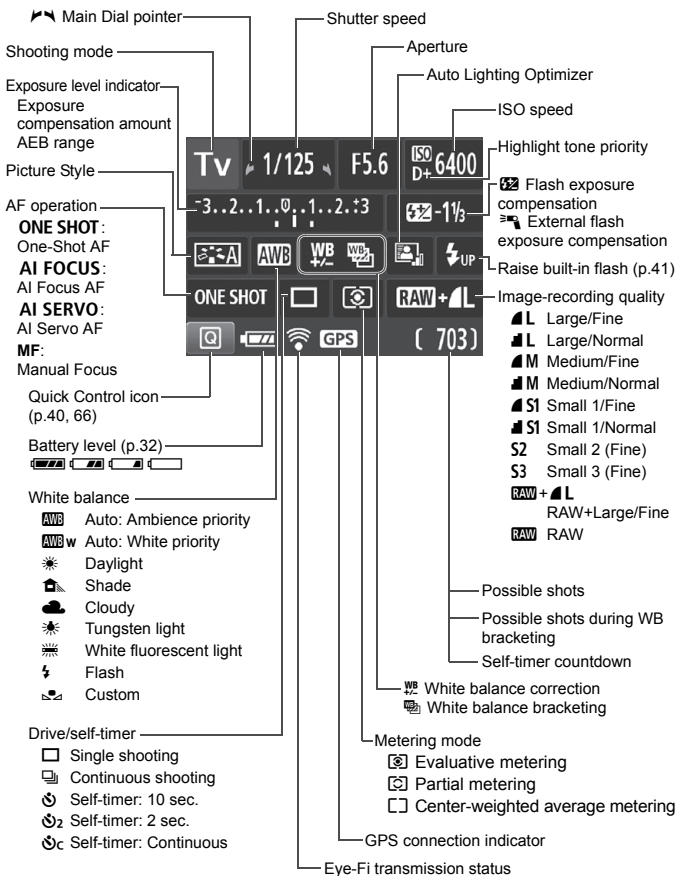

The display will show only the settings currently applied.

## Viewfinder Information

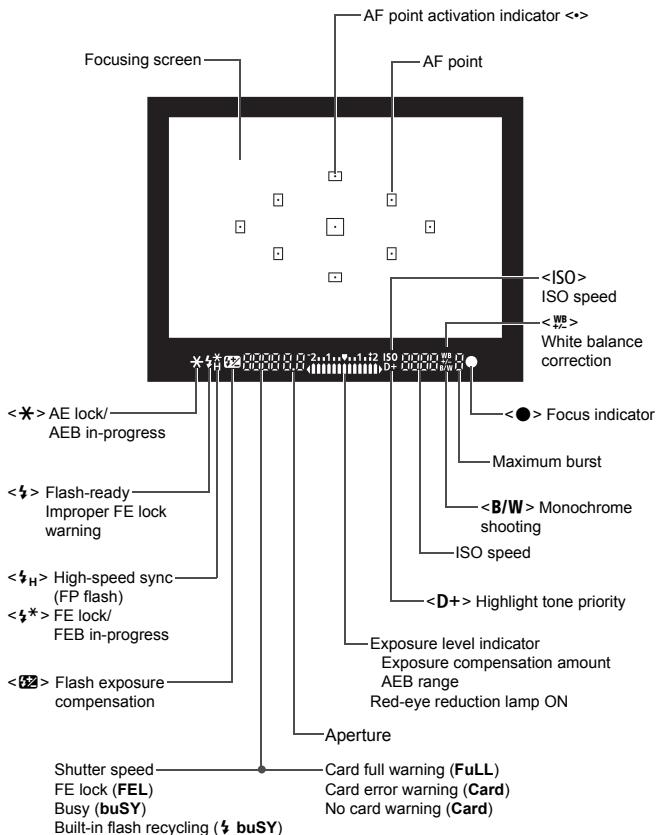

The display will show only the settings currently applied.

## Mode Dial

The Mode Dial includes the Basic Zone modes, Creative Zone modes, and the Movie shooting mode.

### Creative Zone

These modes give you more control for shooting various subjects as desired.

- P** : Program AE
- Tv** : Shutter-priority AE
- Av** : Aperture-priority AE
- M** : Manual exposure

### Basic Zone

All you do is press the shutter button. The camera sets everything to suit the subject or scene for shooting.

- A<sup>+</sup>** : Scene Intelligent Auto (p.50)
- [Flash Off]** : Flash Off (p.55)
- CA** : Creative Auto (p.56)

### Image Zone

- [Portrait]** : Portrait (p.59)
- [Landscape]** : Landscape (p.60)
- [Close-up]** : Close-up (p.61)
- [Sports]** : Sports (p.62)
- [Food]** : Food (p.63)
- [Night Portrait]** : Night Portrait (p.64)

- [Movie Shooting]** : Movie Shooting (p.83)

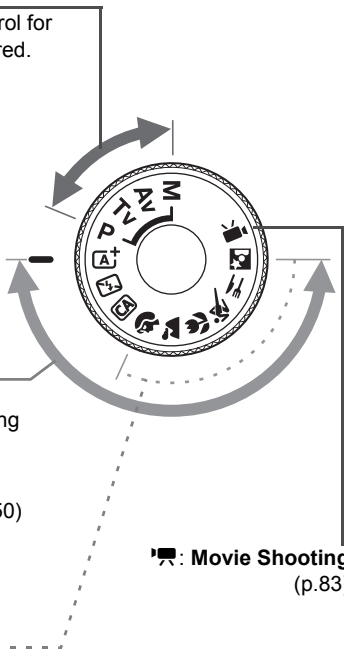

## Battery Charger LC-E10

Charger for Battery Pack LP-E10 (p.26)

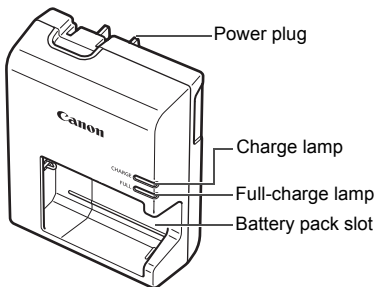

**IMPORTANT SAFETY INSTRUCTIONS-SAVE THESE INSTRUCTIONS.  
DANGER-TO REDUCE THE RISK OF FIRE OR ELECTRIC SHOCK,  
CAREFULLY FOLLOW THESE INSTRUCTIONS.**

For connection to a supply not in the U.S.A., use an attachment plug adapter of the proper configuration for the power outlet, if needed.

## Battery Charger LC-E10E

Charger for Battery Pack LP-E10 (p.26).

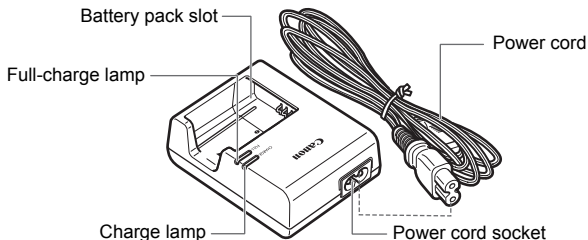

# 1

## Getting Started

This chapter explains preparatory steps before you start shooting and basic camera operations.

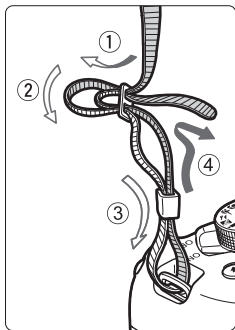

### Attaching the Strap

Pass the end of the strap through the camera's strap mount eyelet from the bottom. Then pass it through the strap's buckle as shown in the illustration. Pull the strap to take up any slack and make sure the strap will not loosen from the buckle.

- The eyepiece cover is attached to the strap.

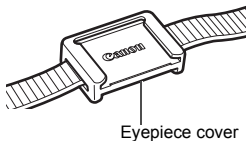

# Charging the Battery

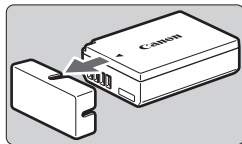

## 1 Remove the protective cover.

- Detach the protective cover provided with the battery.

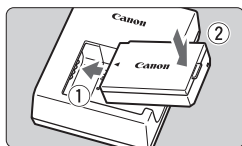

## 2 Attach the battery.

- As shown in the illustration, attach the battery securely to the charger.
- To detach the battery, follow the above procedure in reverse.

### LC-E10

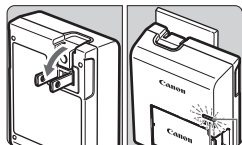

## 3 Recharge the battery.

### For LC-E10

- As shown by the arrow, flip out the battery charger's prongs and insert the prongs into a power outlet.

### For LC-E10E

- Connect the power cord to the charger and insert the plug into a power outlet.

Full-charge lamp

Charge lamp

### LC-E10E

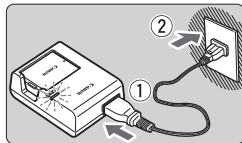

- ▶ Recharging starts and the charge lamp lights up in orange.
- ▶ When the battery is fully recharged, the full-charge lamp will light up in green.

- It takes approx. 2 hours to fully recharge a completely exhausted battery at room temperature (23°C / 73°F). The time required to recharge the battery will vary greatly depending on the ambient temperature and the battery's remaining capacity.
- For safety reasons, recharging in low temperatures (6°C - 10°C / 43°F - 50°F) will take longer (up to approx. 4 hours).



## Tips for Using the Battery and Charger

- **Upon purchase, the battery is not fully charged.**  
Charge the battery before use.
  - **Recharge the battery on the day before or on the day it is to be used.**  
Even during storage, a charged battery will gradually drain and lose its capacity.
  - **After recharging the battery, detach it and disconnect the charger from the power outlet.**
  - **When not using the camera, remove the battery.**  
If the battery is left in the camera for a prolonged period, a small amount of power current is released, resulting in excess discharge and shorter battery life. Store the battery with the protective cover (provided) attached. Storing the battery when it is fully charged may lower the battery's performance.
  - **The battery charger can also be used in foreign countries.**  
The battery charger is compatible with a 100 V AC to 240 V AC 50/60 Hz power source. If necessary, attach a commercially-available plug adapter for the respective country or region. Do not attach any portable voltage transformer to the battery charger. Doing so can damage the battery charger.
  - **If the battery becomes exhausted quickly even after being fully charged, the battery has reached the end of its service life.**  
Purchase a new battery.
- 
- After disconnecting the charger's power plug, do not touch the prongs for at least 3 sec.
  - Do not charge any battery other than a Battery Pack LP-E10.
  - Battery Pack LP-E10 is dedicated to Canon products only. Using it with an incompatible battery charger or product may result in malfunction or accidents for which Canon cannot be held liable.

# Installing and Removing the Battery and Card

Load a fully charged Battery Pack LP-E10 into the camera. You can use an SD, SDHC, or SDXC memory card (sold separately) with the camera. The captured images are recorded onto the card.

- ⚠ Make sure the card's write-protect switch is set upward to enable writing and erasing.**

## Installing the Battery and Card

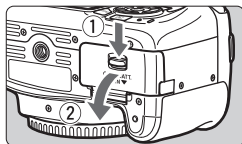

### 1 Open the cover.

- Slide the lever as shown by the arrows and open the cover.

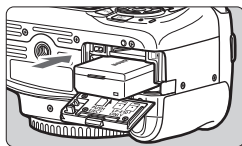

### 2 Insert the battery.

- Insert the end with the electrical contacts.
- Insert the battery until it locks in place.

Write-protect switch

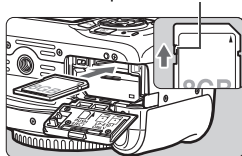

### 3 Insert the card.

- As shown by the illustration, face the card's label side toward the back of the camera and insert it until it clicks in place.

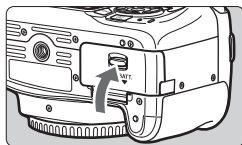

### 4 Close the cover.

- Press the cover until it snaps shut.
- When you set the power switch to <ON>, the number of possible shots (p.32) will be displayed on the LCD monitor.



After opening the card slot/battery compartment cover, be careful not to forcefully swing it back further. Otherwise, the hinge may break.



- The number of possible shots depends on the remaining capacity of the card, image-recording quality, ISO speed, etc.
- Setting [**1**: Release shutter without card] to [Disable] will prevent you from shooting without a card inserted.

## Removing the Battery and Card

**1 Set the power switch to <OFF>**  
(p.31).

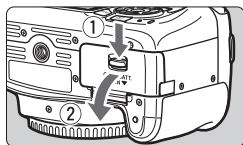

**2 Open the cover.**

- Make sure the access lamp is off, then open the cover.
- If [Recording...] is displayed, close the cover.

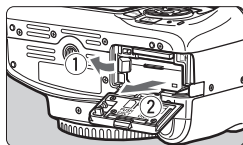

**3 Remove the battery.**

- Press the battery lock lever as shown by the arrow and remove the battery.
- To prevent short circuiting of the electrical contacts, be sure to attach the provided protective cover (p.26) to the battery.

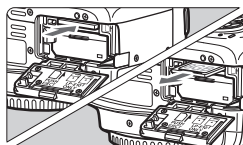

**4 Remove the card.**

- Gently push in the card, then let go to eject it.
- Pull the card straight out.

**5 Close the cover.**

- Press the cover until it snaps shut.

- **When the access lamp is lit or blinking, it indicates that images are being written to, read from, or erased from the card, or data is being transferred. Do not open the card slot/battery compartment cover. Also, never do any of the following while the access lamp is lit or blinking. Otherwise, it can damage the image data, card, or camera.**
  - **Removing the card.**
  - **Removing the battery.**
  - **Shaking or banging the camera around.**
  - **Unplugging and connecting a power cord** (when household power outlet accessories (sold separately) are used).
- If the card already contains recorded images, the image number may not start from 0001.
- If a card-related error message is displayed on the LCD monitor, remove and reinsert the card. If the error persists, use a different card. If you can transfer all the images on the card to a computer, transfer all the images and then format the card with the camera (p.44). The card may then return to normal.
- Do not touch the card's contacts with your fingers or metal objects. Do not expose the contacts to dust or water. If a smudge adheres to the contacts, contact failure may result.
- Multimedia cards (MMC) cannot be used (card error will be displayed).

## Turning on the Power

If you turn on the power and the date/time/zone setting screen appears, see page 33 to set the date/time/zone.

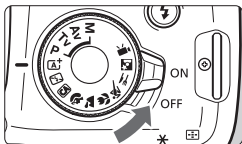

- <ON> : The camera turns on.
- <OFF> : The camera is turned off and does not function. Set to this position when not using the camera.

### **MENU** Auto Power Off

- To save battery power, the camera turns off automatically after approx. 30 seconds of non-operation. To turn on the camera again, just press the shutter button halfway (p.39).
- You can change the auto power off time with [**F1: Auto power off**].





If you set the power switch to <OFF> while an image is being recorded to the card, [**Recording...**] will be displayed and the power will turn off after the recording finishes.

## Battery Level Indicator

When the power is turned on, the battery level will be indicated in one of the four levels.



 : Battery level is sufficient.

 : Battery level is low, but the camera can still be used.

 : Battery will be exhausted soon. (Blinks)

 : Recharge the battery.

## Number of Possible Shots (Approx. number of shots)

Temperature	Room Temperature (23°C / 73°F)	Low Temperatures (0°C / 32°F)
No Flash	600	580
50% Flash Use	500	410

- The figures above are based on a fully-charged Battery Pack LP-E10, no Live View shooting, and CIPA (Camera & Imaging Products Association) testing standards.



- Doing any of the following will exhaust the battery faster:
  - Pressing the shutter button halfway for a prolonged period.
  - Activating the AF frequently without taking a picture.
  - Using the lens Image Stabilizer.
  - Using the LCD monitor frequently.
- The number of possible shots may decrease depending on the actual shooting conditions.
- The lens operation is powered by the camera's battery. Some lenses may exhaust the battery faster than others.
- For the number of possible shots with Live View shooting, see page 71.

## MENU Setting the Date, Time, and Zone

When you turn on the power for the first time or if the date/time/zone have been reset, the date/time/zone setting screen will appear. Follow the steps below to set the time zone first. Set the camera to the time zone in which you currently live so that, when you travel, you can simply change the setting to the correct time zone for your destination, and the camera will automatically adjust the date/time.

**Note that the date/time appended to recorded images will be based on this date/time setting. Be sure to set the correct date/time.**

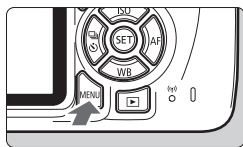

### 1 Display the menu screen.

- Press the <MENU> button to display the menu screen.

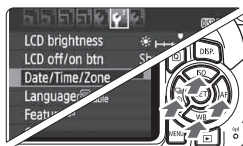

### 2 Under the [Date/Time/Zone] tab, select [Date/Time/Zone].

- Press the <◀> <▶> keys to select the [Date/Time/Zone] tab.
- Press the <▲> <▼> keys to select [Date/Time/Zone], then press <SET>.

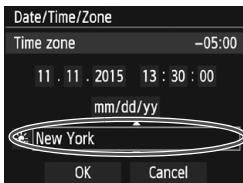

### 3 Set the time zone.

- [London] is set by default.
- Press the <◀> <▶> keys to select the time zone box.
- Press <SET> so <⏏> is displayed.
- Press the <▲> <▼> keys to select the time zone, then press <SET>.  
(Returns to <□>.)



- The menu setting procedure is explained on pages 42-43.
- In step 3, the time displayed on the upper right of the screen is the time difference compared with Coordinated Universal Time (UTC). If you do not see your time zone, set the time zone while referring to the difference with UTC.

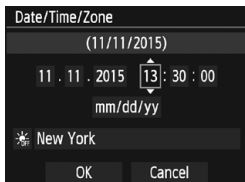

## 4 Set the date and time.

- Press the <◀> <▶> keys to select the number.
- Press <SET> so <☐> is displayed.
- Press the <▲> <▼> keys to set the number, then press <SET>. (Returns to <☐>.)

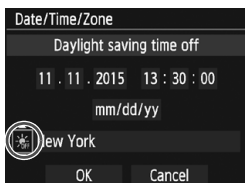

## 5 Set the daylight saving time.

- Set it if necessary.
- Press the <◀> <▶> keys to select [☀].
- Press <SET> so <☐> is displayed.
- Press the <▲> <▼> keys to select [☀], then press <SET>.
- When the daylight saving time is set to [☀], the time set in step 4 will advance by 1 hour. If [☀<sub>off</sub>] is set, the daylight saving time will be canceled and the time will go back by 1 hour.

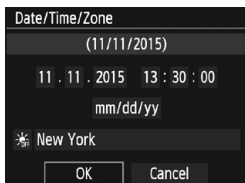

## 6 Exit the setting.

- Press the <◀> <▶> keys to select [OK], then press <SET>.
- ▶ The date/time/zone and daylight saving time will be set and the menu will reappear.

**!** The date/time/zone settings may be reset in the following cases. If this happens, set the date/time/zone again.

- When the camera is stored without the battery.
- When the camera's battery becomes exhausted.
- When the camera is exposed to below freezing temperatures for a prolonged period.

- The date/time that was set will start from when you press <SET> in step 6.
- After changing the time zone, check that the correct date and time are set.

## MENU Selecting the Interface Language

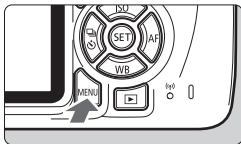

### 1 Display the menu screen.

- Press the <MENU> button to display the menu screen.



### 2 Under the [F2] tab, select [Language].

- Press the <◀> <▶> keys to select the [F2] tab.
- Press the <▲> <▼> keys to select the [Language], then press <SET>.

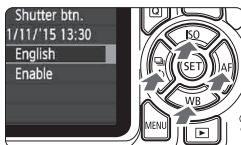

### 3 Set the desired language.

- Press the <▲> <▼> keys to select the language, then press <SET>.
- ▶ The interface language will change.

English	Norsk	Română
Deutsch	Svenska	Türkçe
Français	Español	العربية
Nederlands	Ελληνικά	ภาษาไทย
Dansk	Русский	简体中文
Português	Polski	繁體中文
Suomi	Čeština	한국어
Italiano	Magyar	日本語
Українська		

# Attaching and Detaching a Lens

The camera is compatible with all Canon EF and EF-S lenses. **The camera cannot be used with EF-M lenses.**

## Attaching a Lens

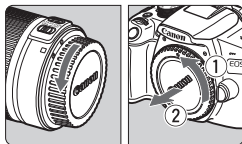

### 1 Remove the caps.

- Remove the rear lens cap and the body cap by turning them as shown by the arrows.

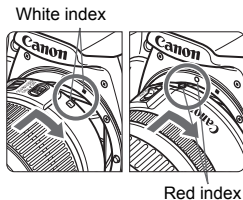

### 2 Attach the lens.

- Align the lens's red or white index with the camera's index matching the same color. Turn the lens as shown by the arrow until it clicks in place.

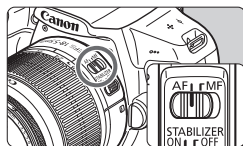

### 3 Set the lens's focus mode switch to <AF>.

- <AF> stands for autofocus.
- If it is set to <MF> (manual focus), autofocus will not operate.

### 4 Remove the front lens cap.

#### Minimizing Dust

- When changing lenses, do it quickly in a place with minimal dust.
- When storing the camera without a lens attached, be sure to attach the body cap to the camera.
- Remove dust on the body cap before attaching it.

## Zooming

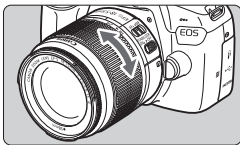

**Turn the zoom ring on the lens with your fingers.**

- If you want to zoom, do it before focusing. Turning the zoom ring after achieving focus may throw off the focus.

## Detaching the Lens

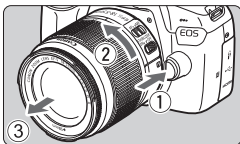

**While pressing the lens release button, turn the lens as shown by the arrow.**

- Turn the lens until it stops, then detach it.
- Attach the rear lens cap to the detached lens.



- Do not look at the sun directly through any lens. Doing so may cause loss of vision.
- **When attaching or detaching a lens, set the camera's power switch to <OFF>.**
- If the front part (focusing ring) of the lens rotates during autofocus, do not touch the rotating part.
- During viewfinder shooting or Live View shooting, if you use a TS-E lens (except the TS-E17mm f/4L or TS-E24mm f/3.5L II) and shift or tilt the lens or use an Extension Tube, the standard exposure may not be obtained or the exposure may be irregular.



## Angle of View

Since the image sensor size is smaller than the 35mm film format, the angle of view of an attached lens will be equivalent to that of a lens with approx. 1.6x of the focal length indicated.

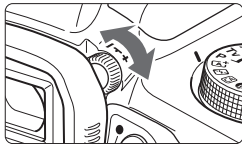

Image sensor size (Approx.)  
(22.3 x 14.9 mm / 0.88 x 0.59 in.)

35mm film size  
(36 x 24 mm / 1.42 x 0.94 in.)

# Basic Operation

## Adjusting the Viewfinder Clarity



### Turn the dioptic adjustment knob.

- Turn the knob left or right so that the AF points (nine boxes) in the viewfinder look the sharpest.
- If the knob is difficult to turn, remove the eyecup.

 If the camera dioptic adjustment still cannot provide a sharp viewfinder image, using E-series Dioptic Adjustment Lenses (sold separately) is recommended.

## Holding the Camera

To obtain sharp images, hold the camera still to minimize camera shake.

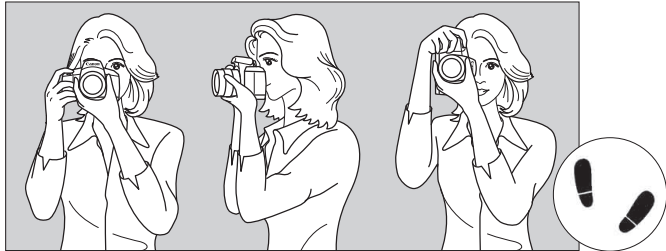

Horizontal shooting

Vertical shooting

1. Wrap your right hand around the camera grip firmly.
2. Hold the lens bottom with your left hand.
3. Rest your hand's right index finger lightly on the shutter button.
4. Press your arms and elbows lightly against the front of your body.
5. To maintain a stable stance, place one foot slightly ahead of the other.
6. Press the camera against your face and look through the viewfinder.

 To shoot while looking at the LCD monitor, see page 69.

## Shutter Button

The shutter button has two steps. You can press the shutter button halfway. Then you can further press the shutter button completely.

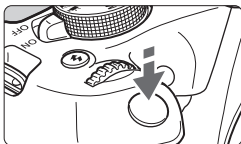

### Pressing Halfway

This activates autofocus and the automatic exposure system that sets the shutter speed and aperture.

The exposure setting (shutter speed and aperture) is displayed in the viewfinder (⦿4).

While you press the shutter button halfway, the LCD monitor will turn off.

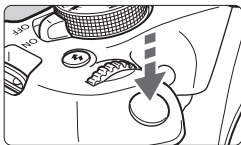

### Pressing Completely

This releases the shutter and takes the picture.

## Preventing Camera Shake

Hand-held camera movement during the moment of exposure is called camera shake. It can cause blurred pictures. To prevent camera shake, note the following:

- Hold and steady the camera as shown on the preceding page.
- Press the shutter button halfway to autofocus, then slowly press the shutter button completely.



- If you press the shutter button completely without pressing it halfway first, or if you press the shutter button halfway and then press it completely immediately, the camera will take a moment before it takes the picture.
- Even during menu display, image playback, or image recording, you can instantly go back to shooting-ready by pressing the shutter button halfway.

## Q Quick Control for Shooting Functions

You can directly select and set the shooting functions displayed on the LCD monitor. This is called Quick Control.



### 1 Press the <Q> button.

- ▶ The Quick Control screen will appear (10).

### 2 Set the desired function.

- Press the <⬆> cross keys to select a function.
- ▶ The settings of the selected function and Feature guide (p.47) will appear.
- Turn the <⚙> dial to change the setting.
- You can also select from a list by selecting a function and pressing <SET>.

#### Basic Zone modes

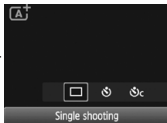

#### Creative Zone modes



### 3 Take the picture.

- Press the shutter button completely to take the picture.
- ▶ The captured image will be displayed.

For the functions settable in Basic Zone modes and their setting procedures, see page 66.

## Sample Quick Control Screen

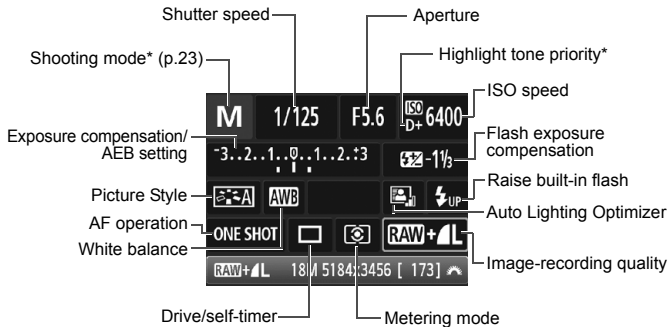

- Functions marked with an asterisk \* cannot be set with the Quick Control.
- When you select <UP> and press <SET>, the built-in flash will be raised.

## Function Setting Screen

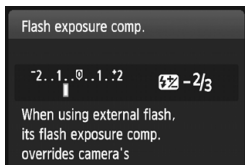
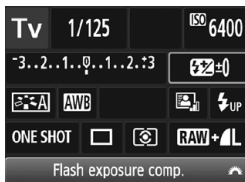

- Select the desired function and press <SET>. The function's setting screen will appear.
- Press the <◀> <▶> keys or turn the <DISP> dial to change some of the settings. Also, some functions can be set by pressing the <DISP> button.
- Press <SET> to finalize the setting and return to the Quick Control screen.

## MENU Menu Operations

You can set various settings with the menus such as the image-recording quality, date and time, etc.

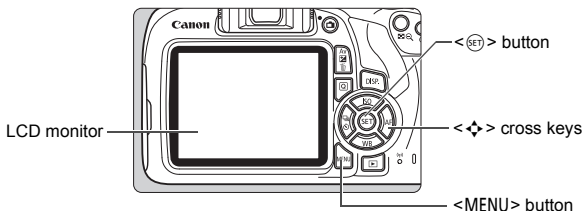

### Menu Screen

The menu tabs and items displayed will differ depending on the shooting mode.

#### Basic Zone modes



#### Movie shooting mode



#### Creative Zone modes

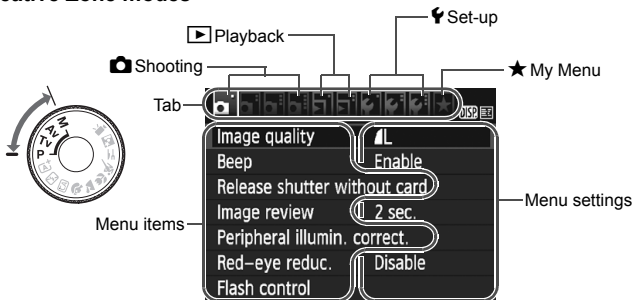

## Menu Setting Procedure

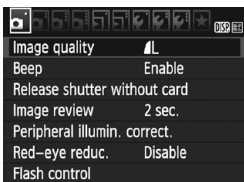

### 1 Display the menu screen.

- Press the <MENU> button to display the menu screen.

### 2 Select a tab.

- Press the <◀> <▶> cross keys to select a tab (group of functions).
- For example, in this manual, “the [CAMERA 3] tab” refers to the screen displayed when the third CAMERA (Shooting) tab from the left [CAMERA] is selected.

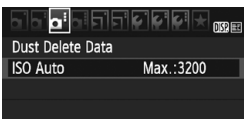

### 3 Select the desired item.

- Press the <▲> <▼> cross keys to select the item, then press <SET>.

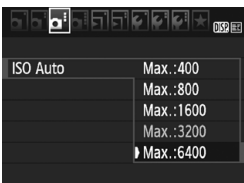

### 4 Select the setting.

- Press the <▲> <▼> or <◀> <▶> cross keys to select the desired setting. (Some settings require you to press either the <▲> <▼> or <◀> <▶> keys to select those settings.)
- The current setting is indicated in blue.

### 5 Set the desired setting.

- Press <SET> to set it.

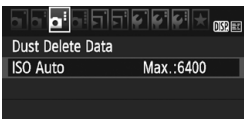

### 6 Exit the setting.

- Press the <MENU> button to return to the shooting function settings display.



- In step 2, you can also turn the <WHEEL> dial to select a menu tab.
- The explanation of menu functions hereafter assumes that you have pressed the <MENU> button to display the menu screen.
- To cancel the operation, press the <MENU> button.

## MENU Formatting the Card

If the card is new or was previously formatted by another camera or computer, format the card with this camera.

**!** When the card is formatted, all images and data on the card will be erased. Even protected images will be erased, so make sure there is nothing you need to keep. If necessary, transfer the images and data to a computer, etc., before formatting the card.

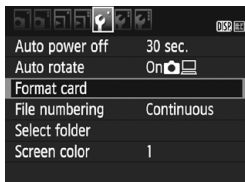

### 1 Select [Format card].

- Under the [**1**] tab, select [**Format card**], then press <SET>.

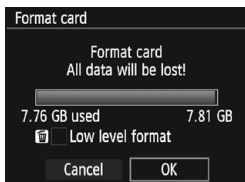

### 2 Format the card.

- Select [**OK**], then press <SET>.
- ▶ The card will be formatted.
- ▶ When the formatting is completed, the menu will reappear.

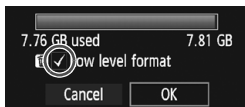

- For low-level formatting, press the <✔> button to add a checkmark [✔] to [**Low level format**], then select [**OK**].



### Format the card in the following cases:

- The card is new.
- The card was formatted by a different camera or a computer.
- The card is full with images or data.
- A card-related error is displayed.

#### Low-level Formatting

- Perform low-level formatting if the card's recording or reading speed seems slow or if you want to totally erase data on the card.
- Since low-level formatting will format all recordable sectors on the card, the formatting will take slightly longer than normal formatting.
- You can stop the low-level formatting by selecting **[Cancel]**. Even in this case, normal formatting will be completed and you can use the card as usual.



- When the card is formatted or data is erased, only the file management information is changed. The actual data is not completely erased. Be aware of this when selling or discarding the card. When discarding the card, execute low-level formatting or destroy the card physically to prevent the personal data from being leaked.
- **Before using a new Eye-Fi card, the software on the card must be installed on your computer. Then format the card with the camera.**



- The card capacity displayed on the card format screen may be smaller than the capacity indicated on the card.
- This device incorporates exFAT technology licensed from Microsoft.

# Switching the LCD Monitor Display

The LCD monitor can display the shooting settings screen, menu screen, captured images, etc.

## Shooting Function Settings

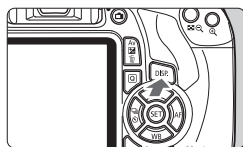

- When you turn on the power, the shooting settings will be displayed.
- **When you press the shutter button halfway, the display will turn off. And when you let go of the shutter button, the display will turn on.**
- **You can also turn off the display by pressing the <DISP.> button.** Press the button again to turn on the display.

## Menu Functions

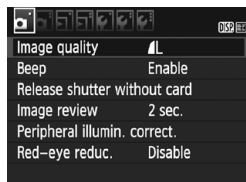

- Appears when you press the <MENU> button. Press the button again to return to the shooting settings screen.

## Captured Image



- Appears when you press the <▶> button. Press the button again to return to the shooting settings screen.

- You can set [**⚡2: LCD off/on btn**] so that the shooting settings display does not keep turning off and on.
- Even when the menu screen or captured image is displayed, pressing the shutter button will enable you to shoot immediately.

# Feature Guide

The Feature guide appears when you change the shooting mode or set a shooting function, Live View shooting, movie shooting, or Quick Control for playback, and displays a brief description of that mode, function or option. It also displays a description when you select a function or option with the Quick Control. The Feature guide turns off when you further proceed with any operation.

## ● Shooting mode (Sample)

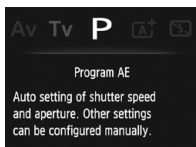
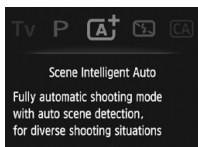

## ● Quick Control (Sample)

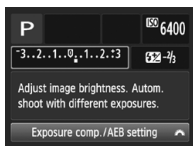

Shooting settings



Live View shooting



Playback

## MENU Disabling the Feature Guide

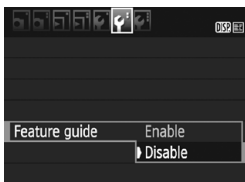

### Select [Feature guide].

- Under the [F2] tab, select [Feature guide], then press <SET>.
- Select [Disable], then press <SET>.





## **[A+]** Fully Automatic Shooting (Scene Intelligent Auto) ■

**<[A+]>** is a fully automatic mode. The camera analyzes the scene and sets the optimum settings automatically. It also adjusts focus automatically by detecting whether the subject is still or moving (p.53).



**1** Set the Mode Dial to **<[A+]>**.

AF point



**2** Aim any AF point over the subject.

- All the AF points will be used to focus, and the camera will focus on the closest object.
- Aiming the center AF point over the subject will make focusing easier.

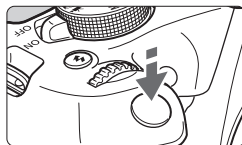

**3** Focus on the subject.

- Press the shutter button halfway. The lens focusing ring will rotate to focus.
- ▶ The dot inside the AF point achieving focus flashes briefly in red. At the same time, the beeper will sound and the focus indicator **<●>** in the viewfinder will light up.
- ▶ If necessary, the built-in flash will be raised automatically.



Focus indicator



## 4 Take the picture.

- Press the shutter button completely to take the picture.
- ▶ The captured image will be displayed for approx. 2 sec. on the LCD monitor.
- After you finish shooting, push down the built-in flash with your fingers.



The **<A<sup>+</sup>>** mode makes the colors look more impressive in nature, outdoor, and sunset scenes. If you did not obtain the desired color tones, change the mode to a Creative Zone mode and select a Picture Style other than **<A>**, then shoot again.

## ? FAQ

- **The focus indicator <●> blinks and focus is not achieved.**  
Aim the AF point over an area with good contrast, then press the shutter button halfway (p.39). If you are too close to the subject, move away and try again.
- **Multiple AF points flash simultaneously.**  
This indicates that focus is achieved at all those AF points. When the AF point covering the desired subject flashes, take the picture.
- **The beeper continues to beep softly. (The focus indicator <●> does not light up.)**  
It indicates that the camera is focusing continuously on a moving subject. (The focus indicator <●> does not light up.) You can take sharp pictures of a moving subject.  
Note that the focus lock (p.53) will not work in this case.
- **Pressing the shutter button halfway does not focus on the subject.**  
If the focus mode switch on the lens is set to **<MF>** (manual focus), set it to **<AF>** (autofocus).

- **The flash fired even though it was daylight.**

For a backlit subject, the flash may fire to help lighten the subject's dark areas. If you do not want the flash to fire, use the Flash off mode (p.55). Other than the flash setting, the camera will shoot with the same settings as with .

- **The flash fired and the picture came out extremely bright.**

Move further away from the subject and shoot. When shooting flash photography, if the subject is too close to the camera, the picture may come out extremely bright (overexposure).

- **In low light, the built-in flash fired a series of flashes.**

Pressing the shutter button halfway may trigger the built-in flash to fire a series of flashes to assist autofocusing. This is called the AF-assist beam. Its effective range is approx. 4 meters / 13.1 feet.

- **When flash was used, the bottom part of the picture came out unnaturally dark.**

The shadow of the lens barrel was captured in the picture because the subject was too close to the camera. Move further away from the subject and shoot. If a hood is attached to the lens, remove it before taking the flash picture.

## **[A<sup>+</sup>]** Full Auto Techniques (Scene Intelligent Auto) ■

### Recomposing the Shot



Depending on the scene, position the subject toward the left or right to create a balanced background and good perspective.

In the <[A<sup>+</sup>]> mode, pressing the shutter button halfway to focus on a still subject will lock the focus on that subject. Recompose the shot while keeping the shutter button pressed halfway, and then press the shutter button completely to take the picture. This is called “focus lock”. Focus lock is also possible in other Basic Zone modes (except <[S] >).

### Shooting a Moving Subject



In the <[A<sup>+</sup>]> mode, if the subject moves (distance to camera changes) while or after you focus, AI Servo AF will take effect to focus on the subject continuously. (The beeper will continue beeping softly.) As long as you keep aiming the AF point on the subject while pressing the shutter button halfway, the focusing will be continuous. When you want to take the picture, press the shutter button completely.

## Live View Shooting

You can shoot while viewing the image on the LCD monitor. This is called “Live View shooting”. For details, see page 69.



### 1 Display the Live View image on the LCD monitor.

- Press the <img alt="Live View button icon" data-bbox="598 251 628 271"/> button.
- ▶ The Live View image will appear on the LCD monitor.



### 2 Focus on the subject.

- Aim the center AF point <img alt="Center AF point icon" data-bbox="318 368 348 388"/> on the subject.
- Press the shutter button halfway to focus.
- ▶ When focus is achieved, the AF point will turn green and the beeper will sound.
- ▶ If necessary, the built-in flash will be raised automatically.

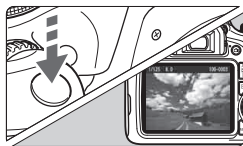

### 3 Take the picture.

- Press the shutter button completely.
- ▶ The picture is taken and the captured image is displayed on the LCD monitor.
- ▶ When the playback display ends, the camera will return to Live View shooting automatically.
- Press the <img alt="Live View button icon" data-bbox="598 788 628 808"/> button to exit the Live View shooting.

## Disabling Flash

The camera analyzes the scene and sets the optimum settings automatically. In places where flash photography is prohibited such as in a museum or an aquarium, use the <> (Flash Off) mode. This mode is also effective for capturing the particular ambience of a scene, such as candlelight scenes.

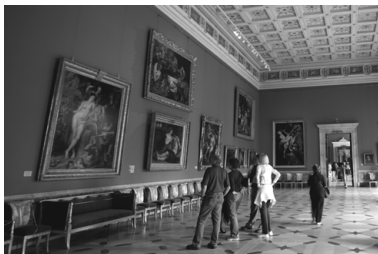
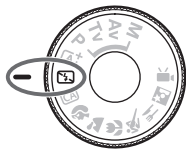

### Shooting Tips

- **Prevent camera shake if the numeric display (shutter speed) in the viewfinder blinks.**

Under low light when camera shake is prone to occur, the viewfinder's shutter speed display will blink. Hold the camera steady or use a tripod. When using a zoom lens, use a wide angle to reduce blur caused by camera shake even with handheld shooting.

- **When shooting portraits without flash.**

In low-light conditions, tell the subject to keep still until the picture is taken. Any movement by the subject during shooting may result in the subject being blurred in the picture.

## **CA** Creative Auto Shooting

In the <CA> mode, you can easily change the depth of field, drive/self-timer, and flash firing. You can also select and shoot with the ambience you want to convey in your images. The default settings are the same as the <A+> mode.

\* CA stands for Creative Auto.



**1** Set the Mode Dial to <CA>.

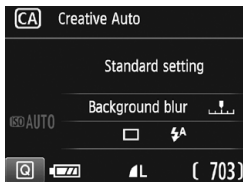

**2** Press the <Q> button (10).

▶ The Quick Control screen will appear.

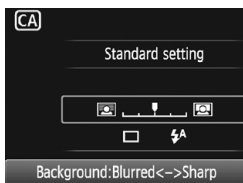

**3** Set the desired function.

- Press the <4-way> cross keys to select a function.
- ▶ The settings of the selected function and Feature guide (p.47) will appear.
- For the setting procedure and details on each function, see pages 57-58.

**4** Take the picture.

- Press the shutter button completely to take the picture.

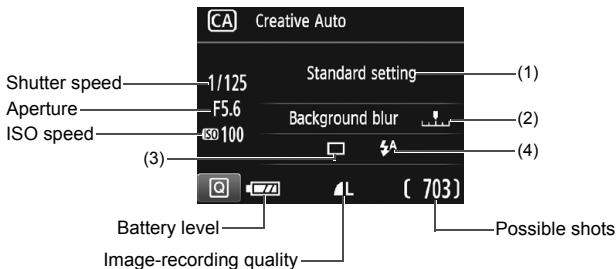

Pressing the **<Q>** button enables you to set the following:

### (1) Ambience-based shots

You can select and shoot with the ambience you want to convey in your images. Press the **<◀>** **<▶>** keys or turn the **<◡>** dial to select the ambience. You can also select it from a list by pressing **<SET>**.





### (2) Blurring/sharpening the background



If you move the index mark toward the left, the background will look more blurred. If you move it toward the right, the background will look more in focus. If you want to blur the background, see “Shooting Portraits” on page 59. Press the **<◀>** **<▶>** keys or turn the **<◡>** dial to select the desired degree of blur.

Depending on the lens and shooting conditions, the background may not look so blurred.

This function cannot be set if you use flash. Also, the setting will not be applied if **<⚡A>** has been selected and the flash is fired.

**(3) Drive/self-timer:** Press  and set it with the   keys or  dial.



 **Single shooting:** Shoot one image at a time.





 **Continuous shooting:**

While you hold down the shutter button completely, shots will be taken continuously. You can shoot up to approx. 3 shots per second.

 **Self-timer: 10 sec. :** The picture is taken 10 seconds after you press the shutter button.

 **Self-timer: Continuous:**

Press the   keys to set the number of multiple shots (2 to 10) to be taken with the self-timer. 10 seconds after you press the shutter button, the set number of multiple shots will be taken.

**(4) Built-in flash firing:** Press  and set it with the   keys or  dial.

 **Auto built-in flash :** The flash fires automatically when necessary.

 **Built-in flash on :** The flash fires at all times.

 **Built-in flash off :** The flash is disabled.

## Shooting Portraits

The <img alt="Portrait mode icon" data-bbox="165 87 195 110"/> (Portrait) mode blurs the background to make the human subject stand out. It also makes skin tones and hair look softer.

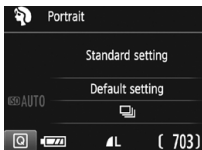
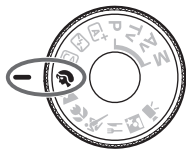

### Shooting Tips

- **Select the location where the distance between the subject and the background is the farthest.**

The further the distance between the subject and background, the more blurred the background will look. The subject will also stand out better against an uncluttered dark background.

- **Use a telephoto lens.**

If you have a zoom lens, use the telephoto end to fill the frame with the subject from the waist up. Move in closer if necessary.

- **Focus on the face.**

Check that the AF point covering the face lights up. For close-ups of the face, focus on the eyes.



- If you hold down the shutter button, you can shoot continuously (max. approx. 3.0 shots/sec.) to capture changes in the subject's facial expression and pose.
- If necessary, the built-in flash will fire automatically.

## Shooting Landscapes

Use the <  > (Landscape) mode for wide scenery or to have everything in focus from near to far. For vivid blues and greens, and very sharp and crisp images.

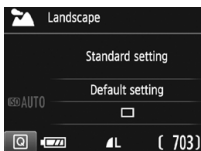
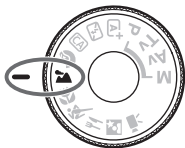

### Shooting Tips

- **With a zoom lens, use the wide-angle end.**

When using the wide-angle end of a zoom lens, objects near and far will be in focus better than at the telephoto end. It also adds breadth to landscapes.

- **When shooting night scenes.**

Since the built-in flash will be disabled, this mode <  > is also good for night scenes.

Use a tripod to prevent camera shake.

If you want to shoot a person against a night scene, set the Mode Dial to <  > (Night Portrait) and use a tripod (p.64).





- The built-in flash will not fire even in backlit or low-light conditions.
- If you are using an external Speedlite, the Speedlite will fire.

## Shooting Close-ups

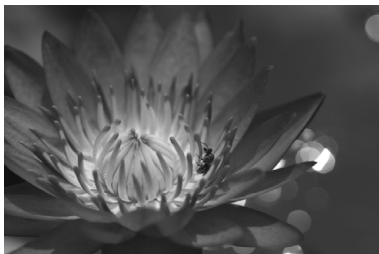
When you want to shoot flowers or small things up close, use the <  > (Close-up) mode. To make small things appear much larger, use a macro lens (sold separately).



### Shooting Tips

- **Use a simple background.**  
A simple background makes small objects such as flowers stand out better.
- **Move in as close as possible to the subject.**  
Check the lens for its minimum focusing distance. Some lenses have indications such as < **MACRO 0.25m/0.8ft** > on them. The lens minimum focusing distance is measured from the <  > (focal plane) mark on the top of the camera to the subject. If you are too close to the subject, the focus indicator <  > will blink.  
If you use flash and the bottom part of the picture comes out unnaturally dark, move away from the subject and try again.
- **With a zoom lens, use the telephoto end.**  
If you have a zoom lens, using the telephoto end will make the subject look larger.



If necessary, the built-in flash will fire automatically.

## Shooting Moving Subjects

Use the  (Sports) mode to shoot a moving subject, such as a running person or a moving vehicle.

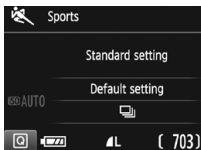
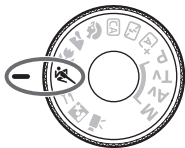

### Shooting Tips

- **Use a telephoto lens.**

The use of a telephoto lens is recommended for shooting from a distance.

- **Use the center AF point to focus.**

Aim the center AF point over the subject, then press the shutter button halfway to autofocus. During autofocusing, the beeper will continue beeping softly. If focus cannot be achieved, the focus indicator  will blink.

When you want to take the picture, press the shutter button completely. If you hold down the shutter button, you can shoot continuously (max. approx. 3 shots/sec.) while maintaining autofocusing to capture changes in the subject's movement.



- The built-in flash will not fire even in backlit or low-light conditions.
- Under low light when camera shake tends to occur, the viewfinder's shutter speed display on the bottom left will blink. Hold the camera steady and shoot.
- If you are using an external Speedlite, the Speedlite will fire.

## 🍴 Shooting Food

When shooting food, use <🍴> (Food). The photo will look bright and appetizing. Also, depending on the light source, the reddish tinge will be suppressed in the pictures taken under tungsten lights, etc.

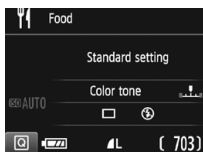
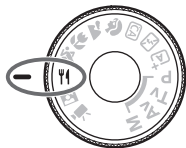

### Shooting Tips

- **Change the color tone.**

You can change [Color tone]. To increase the food's reddish tinge, set it toward [Warm]. Set it toward [Cool] if it looks too red.

- **Avoid using flash.**

If you use flash, the light may reflect off the dish or food and results in unnatural shadows. By default, <🚫> (Built-in flash off) is set. Try to prevent camera shake when shooting in low-light conditions.



- Since this mode lets you shoot the food in appetizing color tones, human subjects may be shot in an unsuitable skin tone.
- The warm color cast of subjects may fade.
- When multiple light sources are included on the screen, the warm color cast of the picture may not be lessened.
- If you use flash, the [Color tone] setting will switch to the standard setting.

## Shooting Night Portraits

To shoot people at night and obtain a natural-looking night scene in the background, use the  (Night Portrait) mode. Using a tripod is recommended.

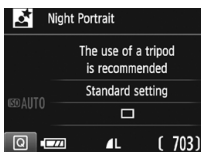
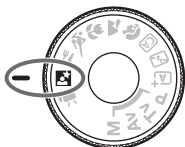

### Shooting Tips

- **Use a wide-angle lens and a tripod.**

When using a zoom lens, use the wide-angle end to obtain a wide night view. Also, use a tripod to prevent camera shake.

- **Check the subject's brightness.**

Under low light, the built-in flash will fire automatically to obtain a good exposure of the subject.

It is recommended to play back the image after shooting to check the image brightness. If the subject looks dark, move nearer and shoot again.

- **Also shoot with the  (Scene Intelligent Auto) mode.**

Since camera shake is prone to occur with night shots, shooting also in the  mode is recommended.

 During Live View shooting, it may be difficult to focus on dots of light such as in a night scene. In such a case, it is recommended that you set the AF method to **[Quick mode]** and shoot. If it is still difficult to focus, set the lens's focus mode switch to **<MF>** and focus manually.

- 
- Tell the subject to keep still even after the flash fires.
  - If you use the self-timer together with flash, the self-timer lamp will light up briefly after the picture is taken.

## **Q** Quick Control

In Basic Zone modes, when the shooting function settings are displayed, you can press the **<Q>** button to display the Quick Control screen. The tables on the next page show the functions that can be set with the Quick Control screen in each Basic Zone mode.

### **1** Set the Mode Dial to a Basic Zone mode.

Example: Portrait mode

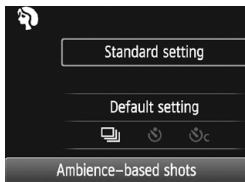

### **2** Press the **<Q>** button (10).

▶ The Quick Control screen will appear.

### **3** Set the desired function.

- Press the **<⬆>** cross keys to select a function. (This step is not necessary in the **A+**/**L** mode.)
  - ▶ The settings of the selected function and Feature guide (p.47) will appear.
- Press the **<◀>** **<▶>** keys or turn the **<☀>** dial to change some of the settings.
- You can also select from a list by selecting a function and pressing **<SET>**.

## Settable Functions in Basic Zone Modes

●: Default setting ○: User selectable □: Not selectable

Function										
Drive/ self-timer	: Single shooting	●	●	●	□	●	●	□	●	●
	: Continuous shooting	□	□	○	●	□	□	●	□	□
	: 10 sec.	○	○	○	○	○	○	○	○	○
	: Continuous shooting*	○	○	○	○	○	○	○	○	○
Built-in flash firing	: Automatic firing	●	□	●	●	□	●	□	□	●
	: Flash on (Fires at all times)	□	□	○	□	□	□	□	○	□
	: Flash off	□	●	○	□	●	□	●	●	□
Ambience-based shots		□	□	○	○	○	○	○	○	○
Light/scene-based shots		□	□	□	○	○	○	○	□	□
Blurring/sharpening the background (p.57)		□	□	○	□	□	□	□	□	□
Color tone (p.63)		□	□	□	□	□	□	□	○	□

\* Use the <▲> <▼> keys to set the number of continuous shots.



If you change the shooting mode or set the power switch to <OFF>, all the functions will revert to the default settings (except the self-timer).

## ▶ Image Playback

The easiest way to play back images is explained below. For more details on the playback procedure, see page 93.



### 1 Play back the image.

- Press the <▶> button.
- ▶ The last image captured or played back will appear.



### 2 Select an image.

- To view images starting with the last captured image, press the <◀> key.
- To view images starting with the first (oldest) image, press the <▶> key.
- Each time you press the <DISP.> button, the information display will change.



Basic information display



Basic information +  
Image quality/Playback number

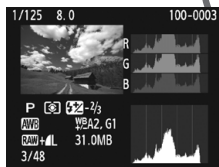

Histogram

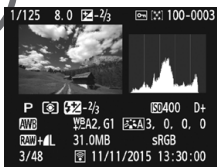

Shooting information display

### 3 Exit the image playback.

- Press the <▶> button to exit the image playback and return to the shooting function settings display.

# 3

## Shooting with the LCD Monitor (Live View Shooting)

You can shoot while viewing the picture on the camera's LCD monitor. This is called "Live View shooting".

**Live View shooting is effective for still subjects which do not move.**

**If you handhold the camera and shoot while viewing the LCD monitor, camera shake can cause blurred images. Using a tripod is recommended.**



### **Remote Live View Shooting**

With EOS Utility (EOS software, p.102) installed on your computer, you can connect the camera to the computer and shoot remotely while viewing the computer screen. For details, refer to the EOS Utility Instruction Manual.

# Shooting with the LCD Monitor



## 1 Display the Live View image.

- Press the  button.
- ▶ The Live View image will appear on the LCD monitor.
- The Live View image will closely reflect the brightness level of the actual image you capture.





## 2 Focus on the subject.

- When you press the shutter button halfway, the camera will focus with the current AF method (p.73).



## 3 Take the picture.

- Press the shutter button completely.
- ▶ The picture is taken and the captured image is displayed on the LCD monitor.
- ▶ When the playback display ends, the camera will return to Live View shooting automatically.
- Press the  button to exit the Live View shooting.

- The image's field of view is approx. 100% (with the image-recording quality set to JPEG ).
- During Live View shooting, the camera will shoot with One-Shot AF in all shooting modes.
- The metering mode will be fixed to evaluative metering for Live View shooting.
- In Creative Zone modes, you can check the depth of field by setting [9: Assign SET button] under [4: Custom Functions (C.Fn)] to [4: Depth-of-field preview] and pressing .
- During continuous shooting, the exposure set for the first shot will also be applied to the subsequent shots.

## Enabling Live View Shooting

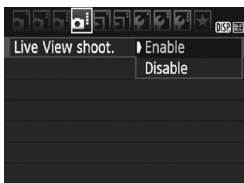

Set [**Live View shoot.**] to [**Enable**]. In Basic Zone modes, the Live View menu options will be displayed under [**2**], and in Creative Zone modes, they will be displayed under [**4**].

## Number of Possible Shots with Live View Shooting

(Approx. number of shots)

Temperature	Room Temperature (23°C / 73°F)	Low Temperatures (0°C / 32°F)
No Flash	190	180
50% Flash Use	180	170

- The figures above are based on a fully-charged Battery Pack LP-E10 and CIPA (Camera & Imaging Products Association) testing standards.
- With a fully-charged Battery Pack LP-E10, continuous Live View shooting is possible for approx. 1 hr. 25 min. at room temperature (23°C / 73°F).



- Do not point the camera toward an intense light source, such as the sun or an intense artificial light source. Doing so may damage the image sensor or the camera's internal components.
- **General Live View Shooting Cautions are on pages 81-82.**



- When flash is used, there will be two shutter sounds, but only one shot will be taken. Also, the time it takes to capture an image after you press the shutter button completely will be slightly longer than with viewfinder shooting.
- If the camera is not operated for a prolonged period, the power will turn off automatically after the time set in [**1: Auto power off**]. If [**1: Auto power off**] is set to [**Disable**], Live View shooting will end automatically after approx. 30 min. (camera power remains on).
- With an HDMI cable (sold separately), you can display the Live View image on a TV set. Note that no sound will be output.

## Information Display

- Each time you press the <DISP.> button, the information display will change.

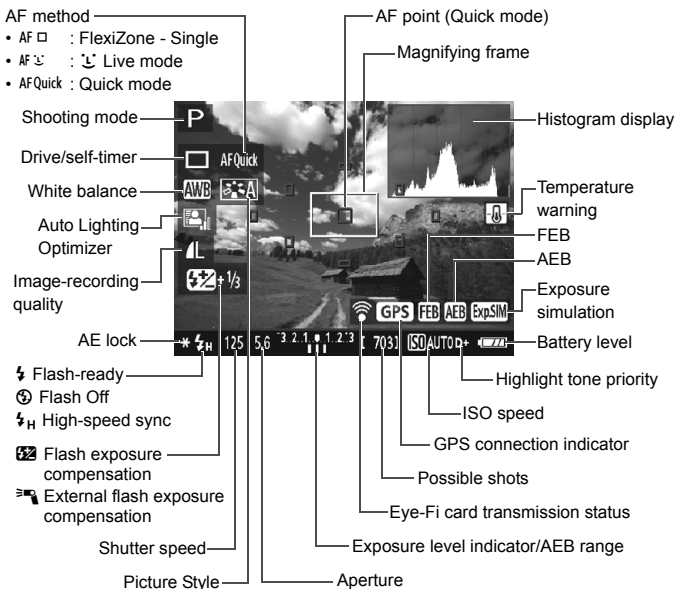

- When <Exp.SIM> is displayed in white, it indicates that the Live View image brightness is close to what the captured image will look like.
- If <Exp.SIM> is blinking, it indicates that the Live View image is displayed at a brightness that differs from the actual shooting result because of low- or bright-light conditions. However, the actual image recorded will reflect the exposure setting. Note that noise may be more noticeable than the actual image recorded.
- If flash is used or bulb exposure is set, the <Exp.SIM> icon and histogram will be grayed out (for your reference). The histogram may not be properly displayed in low- or bright-light conditions.

# Using AF to Focus (AF Method)

## Selecting the AF Method

You can select an AF method to suit the shooting conditions and your subject. The following AF methods are provided: [**FlexiZone - Single**], [**Live mode**] (face detection, p.74), and [**Quick mode**] (p.79).

If you want to achieve precise focus, set the lens's focus mode switch to <MF>, magnify the image, and focus manually.

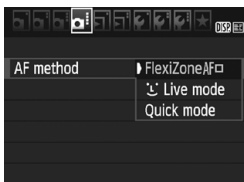

## Select the AF method.

- Under the [**4**] tab, select [**AF method**]. (In Basic Zone modes, it is under the [**2**] tab.)
- Select the desired AF method, then press <SET>.
- While the Live View image is displayed, you can also press the <Q> button to select the AF method with the Quick Control.

## FlexiZone - Single: AF □

The image sensor is used to focus. Although AF is possible with the Live View image displayed, **the AF operation will take longer than with the Quick mode**. Also, achieving focus may be more difficult than with the Quick mode.



AF point

## 1 Display the Live View image.

- Press the <LIVE VIEW> button.
- ▶ The Live View image will appear on the LCD monitor.
- ▶ The AF point <□> will appear.

## 2 Move the AF point.

- Press the <DIRECTIONAL KEYS> cross keys to move the AF point to where you want to focus. (It cannot be moved to the edge of the screen.)
- Press <SET> to return the AF point to the center. (If C.Fn-9 is set, hold down the <AV/DELETE/DELETE> button and press <SET>.)

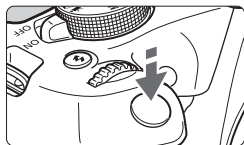

### 3 Focus on the subject.

- Aim the AF point over the subject and press the shutter button halfway.
- ▶ When focus is achieved, the AF point will turn green and the beeper will sound.
- ▶ If focus is not achieved, the AF point will turn orange.



### 4 Take the picture.

- Check the focus and exposure, then press the shutter button completely to take the picture (p.70).

## ☺ (Face detection) Live Mode: AF ☺

Human faces are detected and focused on with the same AF method as FlexiZone - Single. Have the person whose picture you want to take face the camera.



### 1 Display the Live View image.

- Press the <📷> button.
- ▶ The Live View image will appear on the LCD monitor.

### 2 Check the AF point.

- When a face is detected, the <☺> frame will appear on the face for focusing.
- If multiple faces are detected, <☺☺> will be displayed. Use the <◀>▶> keys to move the <☺> frame over the face you want to focus on.

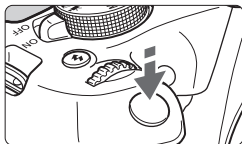

### 3 Focus on the subject.

- Press the shutter button halfway and the camera will focus on the face covered by the <[ ]> frame.
- ▶ When focus is achieved, the AF point will turn green and the beeper will sound.
- ▶ If focus is not achieved, the AF point will turn orange.
- If a face cannot be detected, the AF point <[ ]> will be displayed and AF will be executed at the center.



### 4 Take the picture.

- Check the focus and exposure, then press the shutter button completely to take the picture (p.70).



- If the subject's face is significantly out of focus, face detection will not be possible. If the lens enables manual focusing even while the lens's focus mode switch is set to <AF>, turn the focusing ring to attain rough focus. The face will then be detected and <[ ]> will be displayed.
- An object other than a human face may be detected as a face.
- Face detection will not work if the face is very small or large in the picture, too bright or too dark, tilted horizontally or diagonally, or partially hidden.
- The <[ ]> may cover only a part of the face.



- When you press <SET>, the AF method will switch to [FlexiZone - Single] (p.73). You can press the <+> cross keys to move the AF point. Press <SET> again to return to [L] (Face detection) Live Mode]. (If C.Fn-9 is set, hold down the <Av/ [ ] / [ ]> button and press <SET>.)
- Since AF is not possible with a face detected near the edge of the picture, the <[ ]> will be grayed out. Then if you press the shutter button halfway, the center AF point <[ ]> will be used to focus.

## Notes for [FlexiZone - Single] and [AF Live mode]

### AF Operation

- Focusing will take longer than with [Quick mode].
- Even when focus is achieved, pressing the shutter button halfway will focus again.
- You cannot focus on a moving subject continuously.
- The image brightness may change during and after the AF operation.
- If the light source changes while the Live View image is displayed, the screen may flicker and focusing may be difficult. If this happens, exit Live View shooting and execute AF under the actual light source.

### Magnified View

- When [FlexiZone - Single] is set and you press the <Q> button, the area covered by the AF point will be magnified. Press the shutter button halfway to focus in the magnified view. This is effective when the camera is attached to a tripod and you need to attain very precise focus. If focusing is difficult in magnified view, return to the normal display and use AF. Note that the AF speed may differ between the normal and magnified views.
- If you magnify the view after focusing with [FlexiZone - Single] in the normal view, precise focus may not be achieved.
- If [AF Live mode] is set, magnified view is not possible.

## Shooting Conditions that Make Focusing Difficult

- Low-contrast subjects such as the blue sky, solid-color flat surfaces or when highlight or shadow details are lost.
- Subjects in low light.
- Stripes and other patterns where there is contrast only in the horizontal direction.
- Subjects with repetitive patterns (Example: Skyscraper windows, computer keyboards, etc.).
- Fine lines and subject outlines.
- Under a light source whose brightness, color, or pattern keeps changing.
- Night scenes or points of light.
- The image flickers under fluorescent or LED lighting.
- Extremely small subjects.
- Subjects at the edge of the picture.
- Strongly backlit or reflective subjects (Example: Car with a highly reflective body, etc.).
- The AF point covers both near and distant subjects (Example: Animal in a cage, etc.).
- Subjects that keep moving within the AF point and cannot keep still due to camera shake or subject blur.
- A subject approaching or moving away from the camera.
- Autofocusing while the subject is very far out of focus.
- Soft focus effect is applied with a soft focus lens.
- A special effect filter is used.
- Noise (dots of light, banding, etc.) appears on the screen during AF.



- If focus is not achieved with the shooting conditions on the preceding page, set the lens's focus mode switch to <MF> and focus manually.
- If you use AF with any of the following lenses, using [**Quick mode**] is recommended. Autofocusing with [**FlexiZone - Single**] or [**Live mode**] may take longer or correct focus may not be achieved.  
EF50mm f/1.4 USM, EF50mm f/1.8 II, EF50mm f/2.5 Compact Macro,  
EF100mm f/2.8 Macro USM, EF75-300mm f/4-5.6 II,  
EF75-300mm f/4-5.6 III USM  
For information on other lenses, refer to the Canon Web site.



- If you shoot a peripheral subject and it is slightly out of focus, aim the center AF point over the subject to focus, focus again and then take the picture.
- The AF-assist beam will not be emitted. However, if an EX-series Speedlite (sold separately) equipped with an LED light is used, the LED light will turn on for AF-assist when necessary.
- In magnified view, focusing may be difficult due to camera shake. Using a tripod is recommended.

## Quick Mode: AFQuick

The dedicated AF sensor is used to focus in One-Shot AF, using the same AF method as with viewfinder shooting.

Although you can focus on the target subject quickly, **the Live View image will be interrupted momentarily during the AF operation.**

You can use nine AF points to focus (automatic selection). You can also select one AF point to focus and focus only on the area covered by that AF point (manual selection).

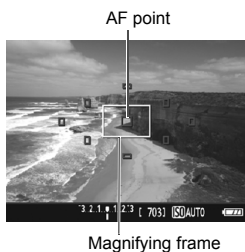





### 1 Display the Live View image.

- Press the <  > button.
- ▶ The Live View image will appear on the LCD monitor.
- The small boxes on the screen are the AF points, and the larger box is the magnifying frame.



### 2 Select the AF point. ☆

- Press the <  > button (  ) to display the Quick Control screen.
- ▶ The settable functions will be displayed on the left of the screen.
- Press the <  > <  > keys to make the AF point selectable.
- Turn the <  > dial to select the AF point.



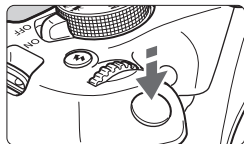

### 3 Focus on the subject.

- Aim the AF point over the subject and press the shutter button halfway.
- ▶ The Live View image will turn off, the reflex mirror will go back down, and AF will be executed. (No picture is taken.)
- ▶ When focus is achieved, the AF point that achieved focus will turn green and the Live View image will reappear.
- ▶ If focus is not achieved, the AF point will turn orange and blink.



### 4 Take the picture.

- Check the focus and exposure, then press the shutter button completely to take the picture (p.70).



 You cannot take a picture during autofocus. Take the picture while the Live View image is displayed.



## General Live View Shooting Cautions

### Image Quality

- When you shoot at high ISO speeds, noise (such as dots of light and banding) may become noticeable.
- Shooting in high temperatures may cause noise and irregular colors in the image.
- If Live View shooting is used continuously for a prolonged period, the camera's internal temperature may rise, and image quality may deteriorate. Always exit Live View shooting when you are not shooting.
- If you shoot a long exposure while the camera's internal temperature is high, image quality may deteriorate. Exit Live View shooting and wait a few minutes before shooting again.

### White <[Icon]> and Red <[Icon]> Internal Temperature Warning Icons

- If the camera's internal temperature increases due to prolonged Live View shooting or under a high ambient temperature, a white <[Icon]> or red <[Icon]> icon will appear.
- The white <[Icon]> icon indicates that the image quality of still photos will deteriorate. It is recommended that you temporarily exit Live View shooting and allow the camera to cool down before shooting again.
- The red <[Icon]> icon indicates that the Live View shooting will soon stop automatically. If this happens, you will not be able to shoot again until the camera's internal temperature decreases. Exit the Live View shooting or turn off the power and let the camera rest for a while.
- Using Live View shooting at a high temperature for a prolonged period will cause the <[Icon]> or <[Icon]> icon to appear earlier. When you are not shooting, always turn off the camera.
- If the camera's internal temperature is high, the quality of images shot with high ISO speed or long exposure may deteriorate even before the white <[Icon]> icon is displayed.

### Shooting Results

- If you take the picture in magnified view, the exposure may not come out as desired. Return to the normal view before taking the picture. In magnified view, the shutter speed and aperture will be displayed in orange. Even if you take the picture in magnified view, the image area for the normal view will be captured.
- If you use a TS-E lens (except the TS-E17mm f/4L or TS-E24mm f/3.5L II) and shift or tilt the lens or use an Extension Tube, the standard exposure may not be obtained or an irregular exposure may result.

## General Live View Shooting Cautions

### Live View Image

- Under low- or bright-light conditions, the Live View image may not reflect the brightness of the captured image.
- Even if a low ISO speed is set, noise may be noticeable in the displayed Live View image under low light. However, when you shoot, the image recorded will have less noise. (The image quality of the Live View image is different from that of the recorded image.)
- If the light source (illumination) within the image changes, the screen may flicker. If this happens, exit Live View shooting and resume Live View shooting under the actual light source.
- If you point the camera in a different direction, it may throw off the Live View image's correct brightness momentarily. Wait until the brightness level stabilizes before shooting.
- If there is a very bright light source in the image, the bright area may appear black on the LCD monitor. However, the actual captured image will correctly show the bright area.
- In low light, if you set the [**F2: LCD brightness**] to a bright setting, noise or irregular colors may appear in the Live View image. However, the noise or irregular colors will not be recorded in the captured image.
- When you magnify the image, the image sharpness may look more pronounced than in the actual image.

### Custom Functions

- During Live View shooting, some Custom Function settings will not take effect.

### Lens and Flash

- During Live View shooting, focus preset for super telephoto lenses cannot be used.
- FE lock will not work when the built-in flash or an external Speedlite is used. Modeling flash will not work if an external Speedlite is used.

## Do not hold the camera in the same position for long periods of time.

Even if the camera does not feel too hot, prolonged contact with the same body part may cause skin redness or blistering due to low-temperature contact burns. Using a tripod is recommended for people with circulation problems or very sensitive skin, or when using the camera in very hot places.

# 4

## Shooting Movies

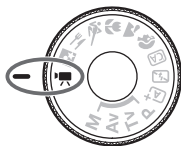

Movie shooting is enabled by setting the Mode Dial to <img alt="movie camera icon" data-bbox="765 475 795 495"/>. The movie recording format will be MOV.

- For cards that can record movies, see page 5.



### Full HD 1080

Full HD 1080 indicates compatibility with High-Definition featuring 1080 vertical pixels (scanning lines).



# Shooting Movies

Connecting the camera to a TV set is recommended to play back the movies shot.

## Autoexposure Shooting



### 1 Set the Mode Dial to <Movie icon>.

- ▶ The reflex mirror will make a sound, then the image will appear on the LCD monitor.

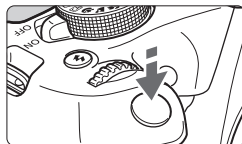

### 2 Focus on the subject.

- Before shooting a movie, focus with AF or manual focus (p.73-80).
- When you press the shutter button halfway, the camera will focus with the current AF method.



### 3 Shoot the movie.

- Press the <Movie icon> button to start shooting a movie. To stop movie shooting, press <Movie icon> again.
- ▶ While the movie is being shot, the [●] mark will be displayed on the upper right of the screen.
- ▶ Sound will be recorded by the built-in microphone.

Recording movie

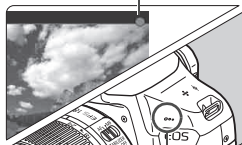







Built-in microphone



- **General Movie Shooting Cautions are on pages 91-92.**
- **If necessary, also read General Live View Shooting Cautions on pages 81-82.**



- The ISO speed (ISO 100 - ISO 6400), shutter speed, and aperture are set automatically.
- You can press the <  > button to lock the exposure (AE lock). The exposure setting will be displayed for the number of seconds set with [ **2: Metering timer**]. After applying AE lock during movie shooting, you can cancel it by pressing the <  > button. (AE lock setting is retained until you press the <  > button.)
- By holding down the <  > button and turning the <  > dial, you can set the exposure compensation.
- If you shoot a movie with autoexposure, the ISO speed, shutter speed, and aperture will not be recorded in the movie's Exif information.
- With autoexposure movie shooting, the camera will automatically turn on the Speedlite's LED light under low-light conditions. For details, refer to the Speedlite's instruction manual.

## Information Display

- Each time you press the <DISP.> button, the information display will change.

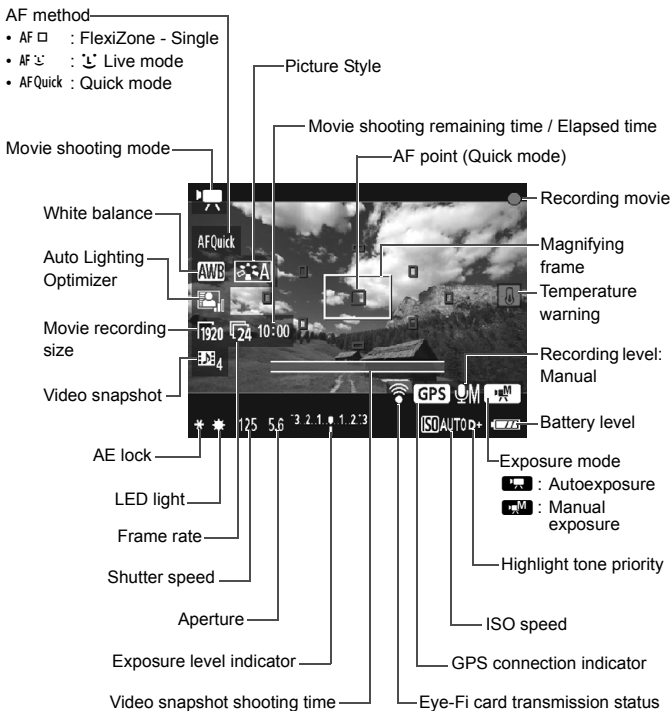

- If there is no card in the camera, the movie shooting remaining time will be displayed in red.
- When movie shooting starts, the movie shooting remaining time will change to the elapsed time.





## Notes for Movie Shooting



### **Do not hold the camera in the same position for long periods of time.**

Even if the camera does not feel too hot, prolonged contact with the same body part may cause skin redness or blistering due to low-temperature contact burns. Using a tripod is recommended for people with circulation problems or very sensitive skin, or when using the camera in very hot places.



- When [ 1: AF w/ shutter button during ] is set to [Enable], pressing the shutter button halfway during movie shooting will perform autofocus. However, the following may occur.
  - Focus may become far off momentarily.
  - The brightness of the recorded movie may change.
  - The recorded movie may be momentarily still.
  - The movie may record the lens operation sound.
- Do not point the camera toward an intense light source, such as the sun or an intense artificial light source. Doing so may damage the image sensor or the camera's internal components.
- If < > or < > is set and the ISO speed or aperture changes during movie shooting, the white balance may also change.
- If you shoot a movie under fluorescent or LED lighting, the movie may flicker.
- Shooting a few test movies is recommended where you will perform zooming during movie shooting. Zooming during movie shooting may result in recording of changes in exposure or mechanical sound of the lens, or images may be out of focus.
- During movie shooting, you cannot magnify the image even if you press the < > button.
- If you connect or disconnect the HDMI cable during movie shooting, the movie shooting will end.
- Be careful not to cover the built-in microphone (p.84) with your finger, etc.
- **General Movie Shooting Cautions are on pages 91-92.**
- **If necessary, also read General Live View Shooting Cautions on pages 81-82.**



- Movie-related settings are under the [1], [2], and [3] tabs.
- A movie file is recorded each time you shoot a movie (p.90).
- The movie image's field of view is approx. 100% (with movie recording size set to [1920]).
- Monaural sound is recorded by the camera's built-in microphone (p.84).
- With a fully-charged Battery Pack LP-E10, the total movie shooting time will be as follows: approx. 1 hr. 15 min. at room temperature (23°C/73°F), and approx. 1 hr. 10 min. at low temperatures (0°C/32°F).
- During movie shooting, focus preset for super telephoto lenses cannot be used.

## Still Photo Shooting

**Still photo shooting is not possible in movie shooting mode.** To shoot still photos, turn the Mode Dial to change the shooting mode.

## MENU Setting the Movie Recording Size

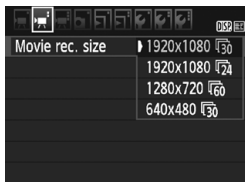

The menu option [**2: Movie rec. size**] enables you to select the movie's image size [\*\*\*\*x\*\*\*\*] and frame rate [**\*/**] (frames recorded per second). The **\*/** (frame rate) switches automatically depending on the [**2: Video system**] setting.







### ● Image Size

- [**1920x1080**] (**30**) : Full High-Definition (Full HD) recording quality. The aspect ratio is 16:9.
- [**1280x720**] (**60**) : High-Definition (HD) recording quality. The aspect ratio is 16:9.
- [**640x480**] (**30**) : Standard-definition recording quality. The aspect ratio is 4:3.

### ● Frame Rate (fps: frame per second)

- 30** / **60** : For areas where the TV system is NTSC (North America, Japan, South Korea, Mexico, etc.).
- 25** / **50** : For areas where the TV system is PAL (Europe, Russia, China, Australia, etc.).
- 24** : Mainly for motion pictures.

**Total Movie Recording Time and File Size Per Minute** (Approx.)

Movie recording Size		Total Recording Time on Card			File Size
		4 GB	16 GB	64 GB	
[1920x1080]		11 min.	44 min.	2 hr. 59 min.	340 MB/min.
					
					
[1280x720]		11 min.	44 min.	2 hr. 59 min.	340 MB/min.
					
[640x480]		42 min.	2 hr. 50 min.	11 hr. 20 min.	90 MB/min.
					

● **Movie Files Exceeding 4 GB**

Due to the file system, movie shooting will stop automatically if the file size of a single movie clip reaches 4 GB. You can start shooting a movie again by pressing the <> button. (The movie will be recorded as a new movie file.)

● **Movie Shooting Time Limit**

The maximum recording time of one movie clip is 29 min. 59 sec. If the movie shooting time reaches 29 min. 59 sec., the movie shooting will stop automatically. You can start shooting a movie again by pressing the <> button. (The movie will be recorded as a new movie file.)

 An increase of the camera's internal temperature may cause movie shooting to stop before the maximum recording time shown in the table above (p.91).



## General Movie Shooting Cautions

### Red <img alt="Red temperature warning icon" data-bbox="198 138 225 155"/> Internal Temperature Warning Icon

- If the camera's internal temperature increases due to prolonged movie shooting or under a high ambient temperature, a red <img alt="Red temperature warning icon" data-bbox="235 183 262 200"/> icon will appear.
- The red <img alt="Red temperature warning icon" data-bbox="272 227 299 244"/> icon indicates that movie shooting will soon be terminated automatically. If this happens, you will not be able to shoot again until the camera's internal temperature decreases. Turn off the power and let the camera rest for a while.
- Shooting a movie at a high temperature for a prolonged period will cause the <img alt="Red temperature warning icon" data-bbox="309 331 336 348"/> icon to appear earlier. When you are not shooting, always turn off the camera.

### Recording and Image Quality

- If the attached lens has an Image Stabilizer and you set the Image Stabilizer (IS) switch to <ON>, the Image Stabilizer will operate at all times even if you do not press the shutter button halfway. The Image Stabilizer consumes battery power and may shorten the total movie shooting time. If you use a tripod or if the Image Stabilizer is not necessary, it is recommended to set the IS switch to <OFF>.
- The camera's built-in microphone will also pick up camera operation sound.
- If the brightness changes during autoexposure movie shooting, the movie may freeze temporarily. In such cases, shoot movies with manual exposure.
- If there is a very bright light source in the image, the bright area may appear black on the LCD monitor. The movie will be recorded almost exactly as it appears on the LCD monitor.
- In low light, noise or irregular colors may appear in the image. The movie will be recorded almost exactly as it appears on the LCD monitor.

## General Movie Shooting Cautions

### Recording and Image Quality

- If you use a card with a slow writing speed, a five-level indicator may appear on the right of the screen during movie shooting. It indicates how much data has not yet been written to the card (remaining capacity of the internal buffer memory). The slower the card, the faster the indicator will climb upward. If the indicator becomes full, movie shooting will stop automatically.

If the card has a fast writing speed, the indicator will either not appear or the level (if displayed) will hardly go upward.

First, shoot a few test movies to see if the card can write fast enough.



Indicator

### Playback and TV Connection

- If you connect the camera to a TV set with an HDMI cable and shoot a movie at [1920x1080] or [1280x720], the movie being shot will be displayed in a small size on the TV set. The movie will still be recorded in the movie-recording size that was set.
- If you connect the camera to a TV set and shoot a movie, the TV set will not output any sound during the shooting. However, the sound will be properly recorded.

# 5

## Image Playback

---

This chapter explains basic procedures to play back images and movies.

### **Images shot and saved with another device**

The camera may not be able to properly display images captured with a different camera, edited with a computer, or that have had their file names changed.

## ▶ Searching for Images Quickly

### ▣ Displaying Multiple Images on One Screen (Index Display)

Search for images quickly with the index display showing four or nine images on one screen.



#### 1 Play back the image.

- When you press the <▶> button, the last image captured will be displayed.



#### 2 Switch to the index display.

- Press the <DISP Q> button.
- ▶ The 4-image index display will appear. The selected image is highlighted with an orange frame.
- Press the <DISP Q> button again to switch to the 9-image display.
- Pressing the <Q> button will switch the display between nine images, four images and one image displayed.



#### 3 Select an image.

- Press the <◀▶> cross keys to move the orange frame to select an image.
- Turning the <◀▶> dial will display image(s) on the next or previous screen.
- Press <SET> in the index display to display the selected image in the single-image display.

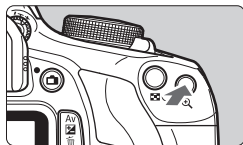

## / **Magnified View**

You can magnify a captured image by approx. 1.5x to 10x on the LCD monitor.





Magnified area position

### **1 Magnify the image.**

- Press the  button during image playback.
- ▶ The image will be magnified.
- If you hold down the  button, the image will be magnified until it reaches the maximum magnification.
- Press the  button to reduce the magnification. If you hold down the button, the magnification will be reduced to the single-image display.

### **2 Scroll around the image.**

- Use the  cross keys to scroll around the magnified image.
- To exit magnified view, press the  button and the single-image display will reappear.

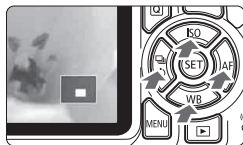

- In magnified view, you can turn the  dial to view another image at the same magnification.
- The image cannot be magnified during the image review immediately after shooting.
- A movie cannot be magnified.

# ▶▶▶ Playing Back Movies



## 1 Play back the image.

- Press the <▶> button to display an image.



## 2 Select a movie.

- Press the <◀> <▶> keys to select a movie.
- In the single-image display, the <▶▶▶ SET> icon displayed on the upper left of the screen indicates a movie. If the movie is a video snapshot, [▶▶▶ SET] will be displayed.
- In the index display, perforations at the left edge of a thumbnail indicate a movie. **As movies cannot be played back from the index display, press <SET> to switch to the single-image display.**



## 3 In the single-image display, press <SET>.

- ▶ The movie playback panel will appear at the bottom of the screen.







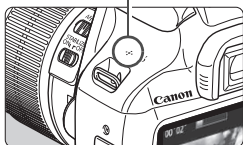



## 4 Play back the movie.

- Select [▶] (Play), then press <SET>.
- ▶ The movie will start playing back.
- You can pause the movie playback by pressing <SET>.
- You can adjust the built-in speaker's volume by turning the <◀> dial even during movie playback.
- For more details on the playback procedure, see the next page.

Speaker

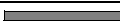

## Movie Playback Panel

Operation	Playback Description
 Exit	Returns to the single-image display.
 Play	Pressing <SET> toggles between play and stop.
 Slow motion	Adjust the slow motion speed by pressing the <◀> <▶> keys. The slow motion speed is indicated on the upper right of the screen.
 First frame	Displays the movie's first frame.
 Previous frame	Each time you press <SET>, the previous frame is displayed. If you hold down <SET>, it will rewind the movie.
 Next frame	Each time you press <SET>, the movie will play frame-by-frame. If you hold down <SET>, it will fast forward the movie.
 Last frame	Displays the movie's last frame.
 Edit	Displays the editing screen.
 Background music*	Plays back a movie with the selected background music.
	Playback position
mm' ss"	Playback time (minutes:seconds)
 Volume	Turn the <VOLUME> dial to adjust the volume of the built-in speaker (p.96).

\* When background music is set, the movie sound will not be played back.





The camera may not be able to play back movies shot with another camera.



- With a fully-charged Battery Pack LP-E10, the continuous playback time at room temperature (23°C / 73°F) will be as follows: Approx. 2 hr. 20 min.
- During the single-image display, you can press the <DISP.> button to change the display format (p.100).
- If you connect the camera to a TV set to play back a movie, adjust the sound volume with the TV set. (Turning the <VOLUME> dial will not change the sound volume.)

## Erasing Images

You can either select and erase unnecessary images one by one or erase them in one batch. Protected images will not be erased.

 Once an image is erased, it cannot be recovered. Make sure you no longer need the image before erasing it. To prevent important images from being erased accidentally, protect them. Erasing a **RAW** +  image will erase both the RAW and JPEG images.

### Erasing a Single Image



**1** Play back the image to be erased.

**2** Press the  button.

▶ The Erase menu will appear.



**3** Erase the image.

- Select **[Erase]**, then press . The image displayed will be erased.

 To erase all images including protected images, format the card (p.44).

# DISP. Shooting Information Display

## Sample Still Photo Taken in a Creative Zone Mode

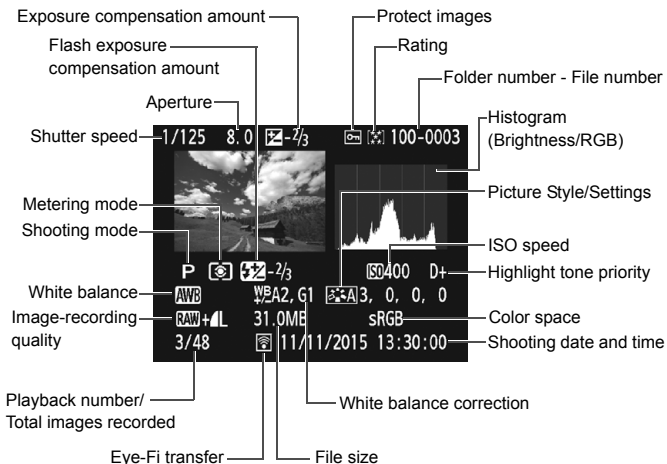

\* With **RAW** + **L** images, the **RAW** file size is displayed.

\* If a Creative filter or Resize has been applied to the image, the **<RAW+>** icon will change to **<RAW+>**.

\* Images taken with flash without any flash exposure compensation are marked with the **<F>** icon. Images taken with flash exposure compensation are marked with the **<FZ>** icon.

- If the image was taken by another camera, certain shooting information may not be displayed.
- It may not be possible to play back images taken with this camera on other cameras.

## Sample Still Photo Taken in a Basic Zone Mode

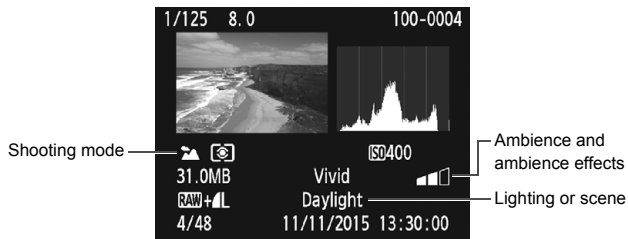

\* With images taken in a Basic Zone mode, the information displayed will differ depending on the shooting mode.

## Sample Movie Information Display

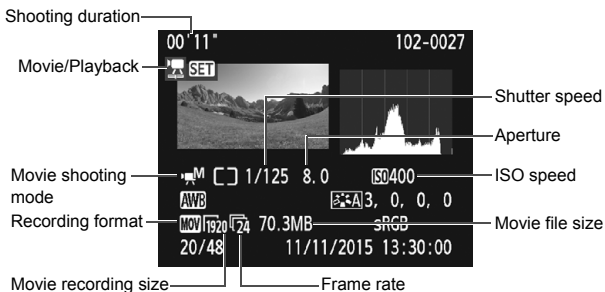

\* If manual exposure is used, the shutter speed, aperture, and ISO speed (when set manually) will be displayed.

\* The  icon will be displayed for video snapshots.

# 6

## Software Start Guide / Downloading Images to a Computer

---

This chapter explains the following:

- Overview of the software for EOS DIGITAL cameras
- How to download and install the software on a computer
- How to download and view the Software Instruction Manuals (PDF files)
- How to download images from the camera to a computer

# Software Start Guide

## Software Overview

This section explains an overview of various software applications for EOS DIGITAL cameras. Internet connection is required to download and install the software. Download and installation are not possible in environments with no Internet connection.

---

### EOS Utility

With the camera connected to a computer, EOS Utility enables you to transfer still photos and movies shot with the camera to the computer. You can also use this software to set various camera settings and shoot remotely from the computer connected to the camera. Also, you can copy background music tracks, such as EOS Sample Music\*, to the card.

\* You can use the background music as the soundtrack for a video snapshot album, movie, or slide show played back with your camera.

### Digital Photo Professional

This software is recommended for users who shoot RAW images. You can view, edit, and print RAW and JPEG images.

\* Some functions differ between the version to be installed on a 64-bit computer and that to be installed on a 32-bit computer.

### Picture Style Editor

You can edit Picture Styles, and create and save original Picture Style files. This software is aimed at advanced users who are experienced in processing images.

## Downloading and Installing the Software



- **Do not connect the camera to your computer before you install the software. Otherwise, the software will not be installed properly.**
- Even if a previous version of the software is installed on your computer, follow the procedure below to install the latest version. (The previous version will be overwritten.)

### 1 Download the software.

- Connect to the Internet from a computer and access the following Canon Web site.

**[www.canon.com/icpd](http://www.canon.com/icpd)**

- Select your country or region of residence and download the software.
- Decompress it on the computer.

For Windows: Click the displayed installer file to start the installer.

For Macintosh: A dmg file will be created and displayed. Follow the steps below to start the installer.

(1) Double-click the dmg file.

- ▶ A drive icon and installer file will appear on the desktop. If the installer file does not appear, double-click the drive icon to display it.

(2) Double-click the installer file.

- ▶ The installer starts.

### 2 Click **[Easy Installation]** and follow the on-screen instructions to install.

- For Macintosh, click **[Install]**.

# Downloading and Viewing the Software Instruction Manuals (PDF Files)

Internet connection is required to download the Software Instruction Manuals (PDF files). Download is not possible in environments with no Internet connection.

---

## 1 Download the Software Instruction Manuals (PDF files).

- Connect to the Internet and access the following Canon Web site.  
**[www.canon.com/icpd](http://www.canon.com/icpd)**
- Select your country or region of residence and download the Instruction Manuals.

## 2 View the Software Instruction Manuals (PDF files).

- Double-click a downloaded Instruction Manual (PDF file) to open it.
- To view the Instruction Manuals (PDF files), Adobe Acrobat Reader DC or other Adobe PDF viewer (most recent version recommended) is required.
- Adobe Acrobat Reader DC can be downloaded free from the Internet.
- To learn how to use a PDF viewer, refer to its Help section.

# Downloading Images to a Computer

You can use the EOS software to download the images in the camera to a computer. There are two ways to do this.

## Downloading by Connecting the Camera to the Computer

### 1 Install the software (p.103).

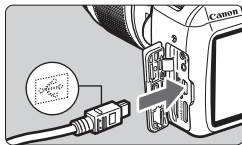

### 2 Use the provided interface cable to connect the camera to a computer.

- Use the interface cable provided with the camera.
- Connect the cable to the camera's digital terminal with the cable plug's <img alt="USB symbol icon" data-bbox="495 435 535 455"/> icon facing the front of the camera.
- Connect the cord's plug to the computer's USB terminal.

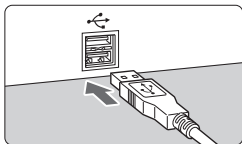

### 3 Use EOS Utility to download the images.

- Refer to the EOS Utility Instruction Manual.

 If [**3: Wi-Fi/NFC**] is set to [**Enable**], the camera cannot be connected to a computer. Set [**Wi-Fi/NFC**] to [**Disable**], then reconnect the camera to a computer with an interface cable.

## Downloading Images with a Card Reader

You can also use a card reader to download images to a computer.

**1** Install the software (p.103).

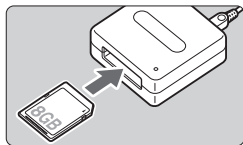

**2** Insert the card into the card reader.

**3** Use Digital Photo Professional to download the images.

- Refer to the Digital Photo Professional Instruction Manual.

 When downloading images from the camera to a computer with a card reader without using EOS software, copy the DCIM folder on the card to the computer.

## Trademarks

- Adobe is a trademark of Adobe Systems Incorporated.
- Microsoft and Windows are trademarks or registered trademarks of Microsoft Corporation in the United States and/or other countries.
- Macintosh and Mac OS are trademarks of Apple Inc., registered in the U.S. and other countries.
- SDXC logo is a trademark of SD-3C, LLC.
- HDMI, HDMI logo, and High-Definition Multimedia Interface are trademarks or registered trademarks of HDMI Licensing LLC.
- All other trademarks are the property of their respective owners.

## About MPEG-4 Licensing

"This product is licensed under AT&T patents for the MPEG-4 standard and may be used for encoding MPEG-4 compliant video and/or decoding MPEG-4 compliant video that was encoded only (1) for a personal and non-commercial purpose or (2) by a video provider licensed under the AT&T patents to provide MPEG-4 compliant video. No license is granted or implied for any other use for MPEG-4 standard."

\* Notice displayed in English as required.

### **Use of genuine Canon accessories is recommended**

This product is designed to achieve excellent performance when used with genuine Canon accessories.

Canon shall not be liable for any damage to this product and/or accidents such as fire, etc., caused by the malfunction of non-genuine Canon accessories (e.g., a leakage and/or explosion of a battery pack). Please note that this warranty does not apply to repairs arising out of the malfunction of non-genuine Canon accessories, although you may request such repairs on a chargeable basis.

## Digital Camera Model DS126621 Systems

This device complies with Part 15 of the FCC Rules. Operation is subject to the following two conditions: (1) This device may not cause harmful interference, and (2) this device must accept any interference received, including interference that may cause undesired operation.

**Note:** This equipment has been tested and found to comply with the limits for class B digital devices, pursuant to Part 15 of the FCC Rules. These limits are designed to provide reasonable protection against harmful interference in a residential installation. This equipment generates, uses and can radiate radio frequency energy and, if not installed and used in accordance with the instructions, may cause harmful interference to radio communications. However, there is no guarantee that interference will not occur in a particular installation. If this equipment does cause harmful interference to radio or television reception, which can be determined by turning the equipment off and on, the user is encouraged to try to correct the interference by one or more of the following measures:

- Reorient or relocate the receiving antenna.
- Increase the separation between the equipment and receiver.
- Connect the equipment into an outlet on a circuit different from that to which the receiver is connected.
- Consult the dealer or an experienced radio/TV technician for help.

The cable with the ferrite core provided with the digital camera must be used with this equipment in order to comply with Class B limits in Subpart B of Part 15 of the FCC rules.

Do not make any changes or modifications to the equipment unless otherwise specified in the manual. If such changes or modifications should be made, you could be required to stop operation of the equipment.

Canon U.S.A. Inc.  
One Canon Park, Melville, NY 11747, U.S.A.  
Tel No. 1-800-OK-CANON (1-800-652-2666)

CAN ICES-3 (B) / NMB-3 (B)



USA and Canada only:

The Lithium ion/polymer battery that powers the product is recyclable. Please call 1-800-8-BATTERY for information on how to recycle this battery.

For CA, USA only

Included lithium battery contains Perchlorate Material – special handling may apply. See [www.dtsc.ca.gov/hazardouswaste/perchlorate/](http://www.dtsc.ca.gov/hazardouswaste/perchlorate/) for details.

### **CAUTION**

RISK OF EXPLOSION IF BATTERY IS REPLACED BY AN INCORRECT TYPE.  
DISPOSE OF USED BATTERIES ACCORDING TO LOCAL REGULATION.

# Index

## Numerics

- 1280x720 (movie) ..... 89
- 1920x1080 (movie) ..... 89
- 640x480 (movie) ..... 89

## A

- A**<sup>†</sup> (Scene Intelligent Auto) ..... 50
- Access lamp ..... 30
- Accessories ..... 3
- Angle of view ..... 37
- Auto Lighting Optimizer ..... 49
- Auto power off ..... 31

## B

- Basic Zone modes ..... 23
- Battery ..... 26, 28, 32

## C

- CA** (Creative Auto) ..... 56
- Cable ..... 3, 105
- Camera
  - Holding the camera ..... 38
- Camera shake ..... 38
- Cards ..... 18, 28, 44
  - Formatting ..... 44
  - Low-level formatting ..... 45
  - SD speed class ..... 5
  - Troubleshooting ..... 30, 45
  - Write protection ..... 28
- Charger ..... 24, 26
- Close-ups ..... 61
- Color tone ..... 63
- Creative Auto ..... 56
- ★ (Creative Zone) icon ..... 8
- Creative Zone modes ..... 23

## D

- Date/time ..... 33
- Daylight saving time ..... 34
- Dial ..... 19
- Digital terminal ..... 105
- Dioptric adjustment ..... 38
- Drive/Self-timer ..... 21, 58

## E

- Erasing images ..... 98
- Eyepiece cover ..... 25

## F









- Feature guide ..... 47
- File size ..... 90, 99
- Fine (image-recording quality) ..... 21
- Flash (Speedlite)
  - Flash off ..... 55, 58, 67
  - Flash sync contacts ..... 19
- Focus indicator ..... 50
- Focus lock ..... 53
- Focus mode switch ..... 36
- Focusing
  - AF method ..... 73
  - Difficult subjects for AF ..... 77
  - Out of focus ..... 38, 77
  - Recomposing ..... 53
- Food ..... 63
- Formatting (card initialization) ..... 44
- Frame rate ..... 89
- Full High-Definition (Full HD) ..... 89
- Fully automatic shooting (Scene Intelligent Auto) ..... 50

## H

- High-Definition (HD) movies ..... 89
- Hot shoe ..... 19

- I**
- Image Zone.....23
  - Images
    - Erasing .....98
    - Index display .....94
    - Magnification .....95
    - Playback.....68, 93
    - Shooting information .....99
  - Index display.....94
- L**
- Landscape .....60
  - Language selection.....35
  - Large (image-recording quality).....21
  - LCD monitor.....17
    - Image playback .....68, 93
    - Menu display .....42
    - Shooting function settings ....21, 46
  - Lens .....36
    - Lock release .....37
  - Live View shooting.....54, 69
    - Face detection Live mode (AF)...74
    - FlexiZone - Single .....73
    - Information display .....72
    - Possible shots .....71
    - Quick mode .....79
- M**
- Macro photography.....61
  - Magnification.....95
  - Medium (image-recording quality)...21
  - Memory cards → Cards
  - Menu.....42
    - Setting procedure .....43
  - MENU** icon .....8
  - Microphone .....84
  - Mode Dial.....23
  - Movies .....83
    - Autoexposure.....84
    - File size.....90
    - Frame rate .....89
    - Information display.....86
    - Manual focus .....84
    - Movie recording size.....89
    - Playback .....96
    - Recording time.....90
- N**
- Night Portrait .....64
  - Night scenes .....60, 64
  - Nomenclature.....19
  - Normal (image-recording quality)...21
  - NTSC .....89
- P**
- PAL.....89
  - Playback.....68, 93
  - Portrait.....59
  - Possible shots .....32, 71
  - Power
    - Battery level.....32
    - Possible shots.....32, 71
    - Recharge .....26
  - Pressing completely .....39
  - Pressing halfway .....39
- Q**
- Q** (Quick Control) .....40, 66
  - Quick Control .....66
  - Quick mode .....79
- R**
- RAW .....21
  - RAW+JPEG .....21
  - Recharging.....26

**S**

Safety precautions .....	13
SD, SDHC, SDXC cards → Cards	
Shooting function settings.....	21, 46
Shooting information display.....	99
Shooting modes .....	23
 (Scene Intelligent Auto) .....	50
 (Flash Off).....	55
 (Creative Auto) .....	56
 (Portrait) .....	59
 (Landscape) .....	60
 (Close-up).....	61
 (Sports).....	62
 (Food) .....	63
 (Night Portrait).....	64
Shutter button .....	39
Single shooting .....	58
Single-image display.....	68
Small (image-recording quality) .....	21
Speaker.....	96
Sports.....	62
Strap .....	25

**T**

Temperature warning .....	81, 91
Time zone .....	33
Tripod socket .....	20

**U**

USB (digital) terminal .....	105
------------------------------	-----

**V**

Video system .....	89
Viewfinder .....	22
Dioptric adjustment.....	38
Volume (movie playback).....	97



# Canon

**EOS**  
**REBEL T6**

**EOS**  
**1300D**

**EOS REBEL T6 (W)**

**EOS 1300D (W)**

## **Wireless Function Basic Instruction Manual**

In Wireless Function Basic Instruction Manual, basic operation procedures for easy-to-use “Connect to a smartphone” and “Save images to Connect Station” are explained.

# Introduction

## What You Can Do Using the Wireless Functions

This camera's wireless functions let you perform a range of tasks wirelessly, from sending images to Web services and other cameras to controlling the camera remotely, simply by connecting to a Wi-Fi® network or other device supporting this camera's wireless functions.

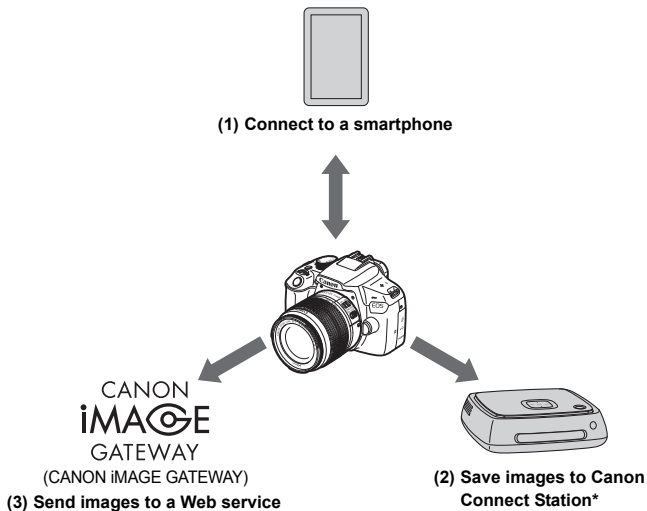

\* Use the latest firmware.

**!** CANON iMAGE GATEWAY Web services are not supported in certain countries and areas. For information on supported countries and areas, refer to the Canon Web site ([www.canon.com/cig](http://www.canon.com/cig)).

**(1)  Connect to a smartphone** (p.W-17)

Connect the camera to a smartphone or tablet wirelessly and use the dedicated application “Camera Connect” to operate the camera remotely or view images stored in the camera.

In this manual and on the camera’s LCD monitor, “smartphone” refers to smartphones and tablets.

**(2) Save images to Connect Station** (p.W-35)

Connect the camera to Connect Station (sold separately) wirelessly to save images.

**(3)  Send images to a Web service**

Share images with family and friends or share images using a range of Web services via CANON IMAGE GATEWAY, an online photo service for Canon users (free registration required).

**Easy Connection Using the NFC Function**

This camera supports NFC\* which enables you to set up a connection between the camera and a smartphone or Connect Station (sold separately) easily. For details, see page W-14.

\* Near Field Communication

**Instruction Manual**

For how to use [**Upload to Web service**] and for more detailed procedures, refer to the “Wireless Function Instruction Manual” PDF file. The “Wireless Function Instruction Manual” PDF file can be downloaded from the Canon Web site (p.4).

# Conventions Used in this Manual

- In this manual, the terms “wireless” and “wireless LAN” are used as general terms for Wi-Fi and Canon’s original wireless functions.

## Icons in this Manual



: Indicates the Main Dial.



: Indicates the <⬆> cross keys on the top, bottom, left, and right.



: Indicates the Setting button.

\* In addition to the above, the icons and symbols used on the camera’s buttons and displayed on the LCD monitor are also used in this manual when discussing relevant operations and functionality.

(p.\*\*): Reference page numbers for more information.

 : Warnings to prevent potential problems during operation.

 : Supplemental information.

- Note that Canon cannot be held liable for any loss or damage from erroneous wireless communication settings for using the camera. In addition, Canon cannot be held liable for any other loss or damage caused by use of the camera.
- When using wireless functions, establish appropriate security at your own risk and discretion. Canon cannot be held liable for any loss or damage caused by unauthorized access or other security breaches.

# Contents

## Introduction W-2

What You Can Do Using the Wireless Functions ..... W-2

Conventions Used in this Manual ..... W-4

## 1 Preparation and Basic Operation W-7

Registering a Nickname ..... W-8

Basic Operation and Settings ..... W-11

NFC Function ..... W-14

Preparation for Smartphones ..... W-16

## 2 Easy Connection to a Smartphone W-17

Connection Method ..... W-18

Connecting Automatically with the NFC Function ..... W-19

Connecting with Easy Connection ..... W-22

Operating the Camera Using a Smartphone ..... W-26

Reconnecting ..... W-28

Easy Image Transfer Using the NFC Function ..... W-30

## 3 Easy Connection to Connect Station W-35

Saving Images ..... W-36

Wi-Fi (Wireless LAN) Precautions ..... W-39

Index ..... W-41



For Troubleshooting guide and Specifications, refer to the Instruction Manual downloadable from the Canon Web site. For how to download the Instruction Manual, see page 4.



# 1

## Preparation and Basic Operation

---

This chapter describes how to register a nickname (for identification) necessary for using the camera's wireless functions and the basic operations.

# Registering a Nickname

First, set the camera's nickname (for identification).

When the camera is connected to another device wirelessly, the nickname will be displayed on the device. **Be sure to set a nickname as otherwise you cannot set the wireless functions.**

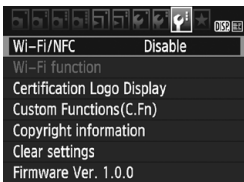

## 1 Select [Wi-Fi/NFC].

- Under the [**3**] tab, select [**Wi-Fi/NFC**], then press <SET>.

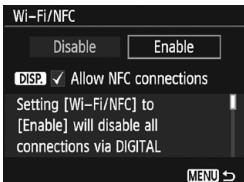

## 2 Select [Enable].

- Press the <▶> key to select [**Enable**], then press <SET>.

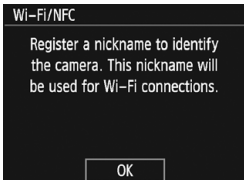

- ▶ When this setting is selected for the first time, a screen to register a nickname is displayed. Press <SET> and proceed to step 3.



### 3 Enter a nickname.

- For instructions on entering characters, see the next page.
- Enter any characters between 1 to 10 characters in length.

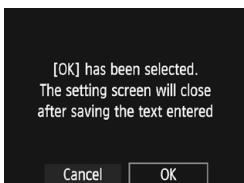

### 4 Exit the setting.

- When you are finished, press the <MENU> button.
- Select [OK] on the confirmation dialog and press <SET> to return to the menu screen.



- The nickname can be changed later from the [**General sett.**] screen.
- By default, the camera name will be displayed for the nickname.

## Virtual Keyboard Operation

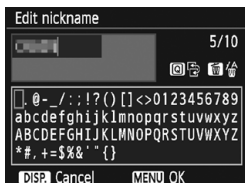

- **Changing the entry area**  
Press the <[Q]> button to toggle between the top and bottom entry areas.
- **Moving the cursor**  
Press the <◀> <▶> keys in the top area to move the cursor.

- **Entering text**

In the bottom area, press the <⬆> cross keys or turn the <🕒> dial to select a character, then press <[SET]> to enter it.

You can check how many characters you have entered, and how many more can be entered, by referring to [\*/] on the upper right of the screen.

- **Deleting a character**

Press the <🗑️> button to delete one character.

- **Finishing the text entry**

Press the <MENU> button to confirm what you have entered and exit. If a confirmation dialog is displayed, select [OK] to exit.

- **Canceling the text entry**

Press the <DISP.> button to cancel text entry and exit. If a confirmation dialog is displayed, select [OK] to exit.

# Basic Operation and Settings

The basic operation for using the camera's wireless functions is explained here. Follow the procedures below.



## 1 Select [Wi-Fi/NFC].

- Under the [**3**] tab, select [**Wi-Fi/NFC**], then press <SET>.

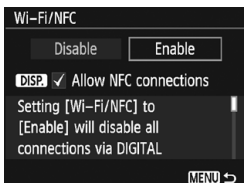

## 2 Select [Enable].

- Press the <▶> key to select [**Enable**], then press <SET>.
- **When a nickname (for identification) is not registered, a registration screen is displayed.** See page W-8 to register a nickname.
- ▶ [**Wi-Fi function**] under the [**3**] tab is now selectable.
- When it is set to [**Enable**], all connections via the DIGITAL and HDMI terminals will be disabled. [**Eye-Fi trans.**] will be set to [**Disable**].

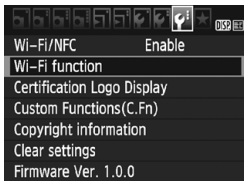

## 3 Select [Wi-Fi function].

- Under the [**3**] tab, select [**Wi-Fi function**], then press <SET>.



## 4 Select the Wi-Fi function to connect to.

- Press the <◀> <▶> keys to select an item.
  - ▶ When the connection settings are not registered, the setting screen is displayed.
  - ▶ When the connection settings are already registered, the reconnection screen is displayed.
- 
- When using the NFC function, see page W-14.

### [Wi-Fi/NFC]

- Set to **[Enable]** to enable the selection of **[Wi-Fi function]** under the **[F3]** tab.
- When the use of electronic devices and wireless devices is prohibited, such as on board airplanes or in hospitals, set it to **[Disable]**.
- When it is set to **[Enable]**, you cannot use the camera by connecting it to Connect Station, a computer, printer, GPS receiver, TV set, or other device with a cable (p.W-13).

### Using the Camera While Wireless Functions Are Active

When you want to prioritize the wireless connection, do not operate the power switch, Mode Dial, card slot/battery compartment cover, or other parts. Otherwise, the wireless connection may be terminated.

## Wireless Connection Status

Wireless connection status can be checked with the camera's <(P)> lamp.

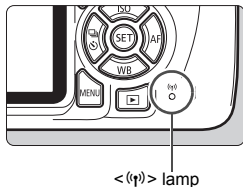

Connection Status	<(P)> lamp
Connected	On
Sending data	Blinking rapidly
Waiting for connection/ Waiting for reconnection	Blinking slowly
Connection error	Blinking somewhat rapidly

### Cable Connection Cautions

- When [⚡3: Wi-Fi/NFC] is set to [Enable], connection via interface cable or HDMI cable is disabled. Set [⚡3: Wi-Fi/NFC] to [Disable] before connecting a cable.
- When the camera is connected to Connect Station, a computer, printer, GPS receiver, TV set, or any other device via a cable, settings for [Wi-Fi/NFC] cannot be changed. Disconnect the cable before changing any settings.

### Cards

- If there is no card in the camera, it cannot be connected wirelessly. Additionally, for [🌐], the camera cannot be connected wirelessly if there are no images saved on the card.

### Using an Eye-Fi Card

- When [⚡3: Wi-Fi/NFC] is set to [Enable], image transfer using an Eye-Fi card is disabled.

# NFC Function

Using an NFC-enabled smartphone or Connect Station enables you to do the following:

- Touch a smartphone to the camera to easily connect them wirelessly (p.W-19).
- While playing back images on the camera, touch a smartphone to the camera to send a captured image to the smartphone (p.W-30).
- Hold the camera close to Connect Station (sold separately) to easily connect them wirelessly (p.W-36).

When using the NFC function, follow the steps below to set the camera's NFC setting.

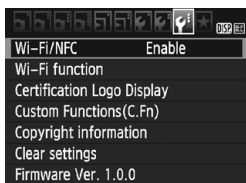

## 1 Select [Wi-Fi/NFC].

- Under the [**F3**] tab, select [**Wi-Fi/NFC**], then press <SET>.

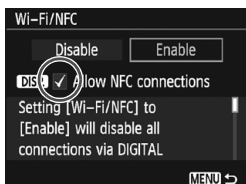

## 2 Add [✓] to [Allow NFC connections].

- Displayed when [**Wi-Fi/NFC**] is set to [**Enable**].
- Press the <DISP.> button to add or remove [✓]. Add [✓], then press <SET>.
- When a nickname (for identification) is not registered, a registration screen is displayed (p.W-8).

 **What is NFC?**  
NFC (Near Field Communication) is a function that can exchange information by simply bringing two NFC-enabled devices close together. This camera uses the NFC function to exchange information regarding wireless connection.

When establishing wireless communications using the NFC function, see the following pages.

Connecting to a smartphone wirelessly: page W-19\*

Sending images to a smartphone: page W-30\*

Connecting to Connect Station: page W-36

\* When connecting to a smartphone, see pages W-16 and W-18 as well.



### NFC Function Cautions

- This camera cannot be connected to other NFC-enabled cameras or printers using the NFC function.
- A connection cannot be established using the NFC function while shooting with the camera or when the Mode Dial is set to <  >.
- To connect the camera to a smartphone using the NFC function, the smartphone's Wi-Fi function and NFC function must be enabled.



A connection can be established even when the camera's power is in the auto power off state. However, if a connection cannot be established, cancel auto power off, then establish a connection.

## Preparation for Smartphones

To use [ ] (Connect to smartphone), a smartphone on which iOS or Android is installed is necessary. In addition, the dedicated application Camera Connect (free of charge) must be installed on the smartphone.

- Camera Connect can be downloaded from the App Store or Google Play.
- For the operating system versions supported by Camera Connect, refer to the download site of Camera Connect.
- When an NFC-enabled smartphone is touched to the camera before installing Camera Connect, the download screen of Camera Connect will be displayed on the smartphone.
- Interface or functions of the camera and Camera Connect are subject to change for firmware update of the camera or application update of Camera Connect, iOS, Android, etc. In such a case, features of the camera or Camera Connect may differ from sample screens or operation instructions in this manual.

# 2

## Easy Connection to a Smartphone

Connecting the camera to a smartphone enables you to do the following:

- View images stored in the camera on a smartphone or save viewed images to a smartphone.
- Operate the camera to take a picture or change camera settings using a smartphone.
- Send images to a smartphone from the camera.

This section explains how to connect the camera directly to a smartphone.



- Install Camera Connect on the smartphone before setting up a connection (p.W-16).



The camera cannot be connected to a smartphone when the Mode Dial is set to <img alt="Smartphone icon" data-bbox="295 928 325 944"/>.

## Connection Method

- **When the smartphone is NFC-enabled: See page W-19.**  
You can easily set up a connection using the NFC function.
- **When the smartphone is not NFC-enabled: See page W-22.**  
Set up a connection by selecting [**Easy connection**].

Smartphones labeled with the  mark are NFC-enabled. Some smartphones are not labeled with the  mark even if they are NFC-enabled; if you do not know whether your smartphone is NFC-enabled, contact the manufacturer of the smartphone.

 A connection may not be established with the NFC function even if the smartphone is NFC-enabled.

## Connecting Automatically with the NFC Function ■

Connect the camera and a smartphone using the NFC function.  
The operation flow for connecting via NFC is as follows.

- (1) Turn on the camera and smartphone.
  - (2) Enable the NFC function on the camera and smartphone.
  - (3) Touch the smartphone to the camera so that they come into contact with each other.
- For the camera's NFC setting, see page W-14.
  - For the smartphone's Wi-Fi setting, NFC setting, and NFC antenna position, refer to the smartphone's instruction manual.

### 1 Enable the NFC function on the camera and smartphone (p.W-14).

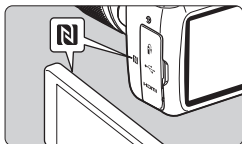

### 2 Touch a smartphone to the camera.

- If an image is being played back on the camera, press the <▶> button to end the playback.
- Touch the **N** mark on the smartphone to that on the camera so that they come into contact with each other.
- **When a message indicating the connection is displayed on the camera's LCD monitor**, move the smartphone away from the camera.
  - ▶ The camera's <ⓁⓂ> lamp will blink.
  - ▶ Camera Connect starts on the smartphone and establishes a connection.

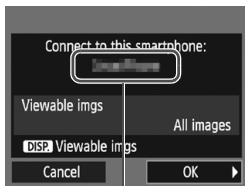

The device name set on Camera Connect

### 3 Connect to the camera.

- When a connection is established, the screen on the left will appear on the camera's LCD monitor. When connecting to the same smartphone, this screen will not appear again.
- ▶ The camera's <(P)> lamp will light up in green.
- Select [OK] and press <SET>.
- ▶ After a message is displayed, the camera's LCD monitor will turn off.
- ▶ The main window of Camera Connect will be displayed on the smartphone.

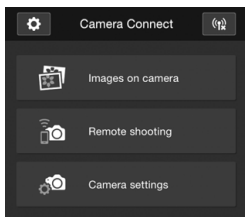
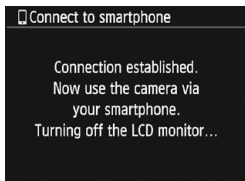

### 4 Operate the camera using Camera Connect.

- Perform further operations using Camera Connect. See page W-26.

The settings for connecting to a smartphone are now complete.

 You can check or change the device name on the setting screen of Camera Connect.



- **If necessary, also read “NFC Function Cautions” (p.W-15).**
- When touching the smartphone to the camera, be careful not to drop the camera or smartphone.
- Do not touch the smartphone to the camera with too much force. Doing so can scratch the camera or smartphone.
- Just holding the smartphone close to the mark may not establish a connection. Be sure to touch the mark with the smartphone so that they come into contact with each other.
- Recognition may be difficult depending on the smartphone. Touch slowly while changing the position or rotating horizontally.
- Another application on the smartphone may start depending on how you touch. Check the position of the  mark, then touch again.
- When touching the smartphone to the camera, do not leave anything between the camera and smartphone. In addition, when a case is attached to the camera or smartphone, communication may not be possible via NFC function.



- The camera cannot be connected to two or more smartphones at the same time.
- By default, the connection settings via the NFC function are saved as the fourth setting (a setting dedicated to NFC connection) under the name **[SET4 (NFC)]**. When you connect the camera to another smartphone via NFC, **[SET4 (NFC)]** will be overwritten.
- While connected, the camera's auto power off does not function.

# Connecting with Easy Connection

The camera and a smartphone can be directly connected wirelessly. No access point is necessary, so you can establish a wireless connection easily.

To establish connection, operations on the smartphone are required. For details, refer to the smartphone's instruction manual.

## Operation on the Camera-1

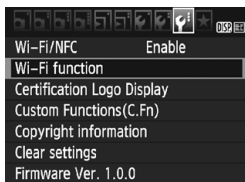

### 1 Select [Wi-Fi function].

- Under the [**3**] tab, set [**Wi-Fi/NFC**] to [**Enable**], then select [**Wi-Fi function**].



### 2 Select [**☐**].

- Select [**☐**] (Connect to smartphone) and press <[**SET**]>.
- ▶ The camera's <[**⦿**]> lamp will blink.

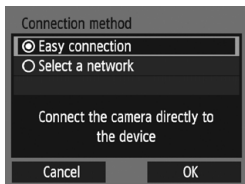

### 3 Select [Easy connection].

- Select [**Easy connection**] and press <[**SET**]>.
- Select [**OK**] and press <[**SET**]> to go to the next screen.

## Operation on the Smartphone-1

Smartphone's screen  
(sample)

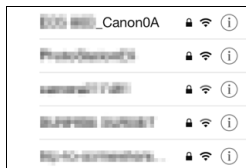

### 4 Operate the smartphone and connect it to the camera.

- Activate the smartphone's Wi-Fi function, then select the SSID (network name) displayed on the camera's LCD monitor.
- For the password, enter the encryption key displayed on the camera's LCD monitor.

Camera's screen

SSID (network name)

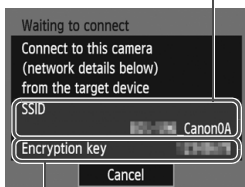

Encryption key (password)



### 5 Start Camera Connect on the smartphone.

- When the [Waiting to connect] screen is displayed on the camera's LCD monitor, start Camera Connect on the smartphone.

 When connecting by selecting [Easy connection], “\_Canon0A” is displayed at the end of the SSID.

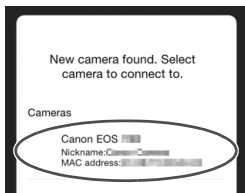

## 6 Select the camera to connect to on the smartphone.

- Select and touch the camera to connect to from **[Cameras]** on Camera Connect.

## Operation on the Camera-2

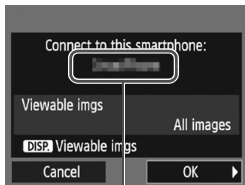

The device name set on Camera Connect

## 7 Connect to the camera.

- When a connection is established, the screen on the left will appear on the camera's LCD monitor.
- Select **[OK]** and press **<SET>**.
  - ▶ The camera's **<(P)>** lamp will light up in green.
  - ▶ After a message is displayed, the camera's LCD monitor will turn off.
  - ▶ The main window of Camera Connect will be displayed on the smartphone.



## Operation on the Smartphone-2

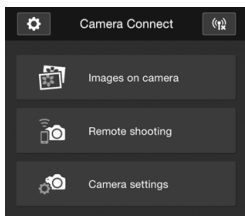

### 8 Operate the camera using Camera Connect.

- Perform further operations using Camera Connect. See page W-26.

The settings for connecting to a smartphone are now complete.



- You can check or change the device name on the setting screen of Camera Connect.
- While connected, the camera's auto power off does not function.

# Operating the Camera Using a Smartphone

You can use a smartphone with Camera Connect installed to view images stored in the camera and shoot remotely.

## Camera Connect Main Window

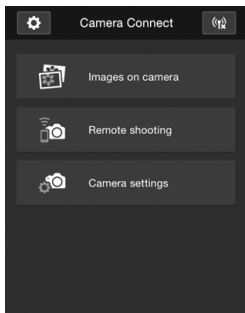

The main functions of Camera Connect are described below. Touch the screen to learn the operation procedures.

### [Images on camera]

- Images stored in the camera can be viewed.
- Images stored in the camera can be saved on a smartphone.
- Operations such as deletion can be performed on images stored in the camera.

### [Remote shooting]

- The camera's Live View image can be viewed using a smartphone.
- You can shoot using remote operation.

### [Camera settings]

- Camera settings can be changed.

### ⚙ (Settings button)

- Use this button to access various settings for Camera Connect.

## Terminating the Connection

To terminate the connection, perform either of the following operations.

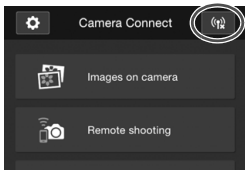

On the smartphone's **Camera Connect** screen, tap **[]**.

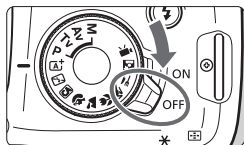

Set the camera's power to **<OFF>**.



- While connected, a picture cannot be taken even if the camera's shutter button is pressed.
- In remote shooting, the AF speed may become slower.
- Depending on the connection status, image display or shutter release may be delayed.
- Even if movies are displayed in the list, they cannot be saved to a smartphone.
- If you send RAW images to a smartphone, the high ISO speed noise reduction effect of saved images on the smartphone may become smaller. Therefore, if you shoot RAW images, setting the image-recording quality to **RAW +  L** is recommended.



- The connection will also be terminated if you turn the Mode Dial or open the card slot/battery compartment cover.
- If you send RAW images to a smartphone, they will be resized to **S2** and saved.
- While connected, the camera's auto power off does not function.
- While connected, disabling the smartphone's power saving function is recommended.
- The camera's **<(P)>** lamp will blink rapidly when images stored in the camera are being saved to a smartphone.

# Reconnecting

The camera can reconnect to a smartphone for which connection settings have been registered.

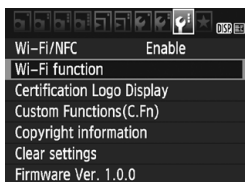

## 1 Select [Wi-Fi function].

- Under the [**3**] tab, set [**Wi-Fi/NFC**] to [**Enable**], then select [**Wi-Fi function**].



## 2 Select [**☐**].

- Select [**☐**] (Connect to smartphone) and press <SET>.

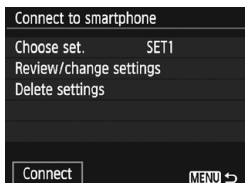

## 3 Select [**Connect**].

- When settings for multiple connection destinations are registered, select [**Choose set.**], select the connection destination, then connect to the destination.
- Select [**Connect**] and press <SET>.
- On the confirmation dialog, select [**OK**].

## 4 Activate the smartphone's Wi-Fi function.

- If the connection destination has been changed, restore the setting to connect to the camera.

## 5 Start Camera Connect on the smartphone.

- A connection will be established.



- If you do not know the SSID of the camera when reconnecting, select **[Review/change settings]** in step 3 to check it.
- With NFC connection or when connecting by selecting **[Easy connection]**, “\_Canon0A” is displayed at the end of the SSID.

## Easy Image Transfer Using the NFC Function ■

While playing back images on the camera, touch an NFC-enabled smartphone to the camera to send a captured image to the smartphone.

- If a connection has already been established wirelessly, terminate the connection and then play back an image on the camera.
- Set up the camera to allow use of its NFC function in advance (p.W-14).
- For the smartphone's Wi-Fi setting, NFC setting, and NFC antenna position, refer to the smartphone's instruction manual.

### Connecting with the NFC Function

**1 Enable the NFC function on the camera and smartphone (p.W-14).**



**2 Play back the image.**

- Press the <▶> button to play back images.

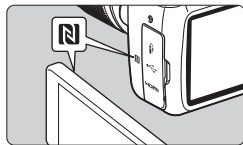

**3 Touch a smartphone to the camera.**

- Touch the **N** mark on the smartphone to that on the camera so that they come into contact with each other.
- When a message indicating the connection is displayed on the camera's LCD monitor, move the smartphone away.
- ▶ The camera's <▶> lamp will light up in green.



## 4 Select the images to send.

- Select and send image(s).
- When the index display is selected in step 2, the multiple image selection screen will appear. See step 3 on page W-32.

## Sending Images Individually

Select and send images individually.



## 1 Select an image to send.

- Press the <◀> <▶> keys to select an image to send, then press <SET>.
- By pressing the <☒ Q> button, you can switch to the index display and select an image.



## 2 Select [Send img shown].

- To select a size at which to send the image, select [Resize image] and press <SET>.
- Select [Send img shown] and press <SET> to send the image displayed.
- ▶ When the transfer is complete, the screen for step 1 will reappear.
- To send another image, repeat steps 1 and 2.

## Sending Multiple Images

Select multiple images and send them at once.

If the multiple image selection screen is displayed, perform from step 3.



**1** Press **<SET>**.

**2** Select **[Send selected]**.

- To select a size at which to send the images, select **[Resize image]** and press **<SET>**.
- Select **[Send selected]** and press **<SET>**.



**3** Select the images to send.

- Press the **<◀>** **<▶>** keys to select the image to send, then press the **<▲>** **<▼>** keys.
  - ▶ A checkmark **[✓]** will be displayed on the upper left of the screen.
- By pressing the **<☒ Q>** button, you can select images from a three-image display.
- After selecting the images to send, press the **<Q>** button to send them.



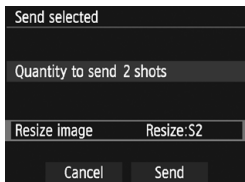

#### 4 Select [Resize image].

- Set it if necessary.
- On the displayed screen, select an image size, then press <SET>.

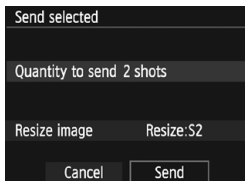

#### 5 Select [Send].

- The selected images will be sent. When the transfer is complete, the screen for step 1 will reappear.
- To send other images, repeat steps 1 to 5.

## Terminating the Connection

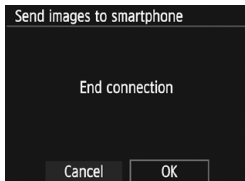

- To end the image transfer, press the <MENU> button on the image transfer screen.
- Select **[OK]** on the confirmation dialog to terminate the connection.

- **If necessary, also read “NFC Function Cautions” (p.W-15).**
- While connected, a picture cannot be taken even if the camera’s shutter button is pressed.
- Images cannot be sent using the NFC function while the camera is connected to another device wirelessly. In addition, the camera cannot be connected to multiple smartphones at the same time.
- Even if movies are displayed in the list, they cannot be saved to a smartphone.
- If you send RAW images to a smartphone, the high ISO speed noise reduction effect of saved images on the smartphone may become smaller. Therefore, if you shoot RAW images, setting the image-recording quality to **RAW** + **L** is recommended.

- You can cancel the image transfer by selecting **[Cancel]** during the transfer.
- You can select up to 50 files at a time.
- While connected, disabling the smartphone’s power saving function is recommended.
- Settings for image transfer using the NFC function are not saved on the camera.
- When you reduce the image size, all images to be sent at the same time are resized. Images that are smaller than **S2** size are not reduced.
- If you send RAW images to a smartphone, they will be resized to **S2** and saved.
- The camera’s <(P)> lamp will blink rapidly when data is being sent.
- When you use a battery to power the camera, make sure it is fully charged.
- While connected, the camera’s auto power off does not function.

# 3

## Easy Connection to Connect Station

---

Connect Station (sold separately) is a device that allows you to import captured still photos and movies for viewing on your TV set, smartphone, etc., or sharing them over a network.

You can easily save still photos and movies to Connect Station by holding this camera close to Connect Station.

# Saving Images

This section explains how to connect the camera and Connect Station (sold separately) wirelessly. To save images in other ways, refer to the Connect Station Instruction Manual.

- Set up the camera to allow use of its NFC function in advance (p.W-14).

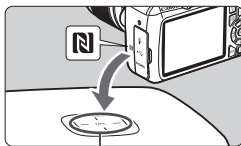

NFC connect point

## 1 Enable the NFC function on the camera (p.W-14).

## 2 Hold the camera close to Connect Station.

- Turn on the camera and Connect Station, then hold the camera's **N** mark close to the Connect Station's NFC connect point.
- ▶ When a message indicating the connection is displayed on the camera's LCD monitor and Connect Station responds, move the camera away from Connect Station.
- When a connection is established, Connect Station checks the images on the memory card, then saves only the unsaved images.
- ▶ The camera's <(P)> lamp will light up in green.

## 3 Terminate the connection.

- After images are saved, the screen on the left will appear on the camera's LCD monitor. Press <SET> to terminate the connection.

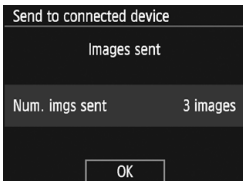



- **If necessary, also read “NFC Function Cautions” (p.W-15).**
- While saving images, a picture cannot be taken even if the camera's shutter button is pressed.
- Do not drop the camera on Connect Station or touch the camera to it with too much force. Doing so may damage Connect Station's internal hard disk.
- If the camera is not recognized right away, try holding it close to Connect Station and slowly moving it or rotating it horizontally.
- Just holding the camera close to Connect Station may not establish a connection. In such a case, gently touch Connect Station with the camera.
- When holding the camera close to Connect Station, do not leave anything between the camera and Connect Station. In addition, when a case is attached to the camera, communication may not be possible via NFC function.
- If the camera and Connect Station are moved too far away from each other while saving images, saving may take time or the connection may be terminated.
- If the camera's battery runs out while saving images, the saving will stop. Charge the battery, then try again.



- When all images are already saved, saving will not start. In such a case, select **[OK]** to terminate the connection.
- When there are a large number of images on the memory card, it may take time to check and save the images.
- While saving images, the camera's auto power off does not function.



# Wi-Fi (Wireless LAN) Precautions

## ■ Countries and Regions Permitting Wireless LAN Use

Use of wireless LAN is restricted in some countries and regions, and illegal use may be punishable under national or local regulations. To avoid violating wireless LAN regulations, visit the Canon Web site to check where use is allowed.

Note that Canon cannot be held liable for any problems arising from wireless LAN use in other countries and regions.

## ■ Model Number

EOS REBEL T6 (W)/EOS 1300D (W): DS126621 (including WLAN module model: ES200)

Complies with  
IDA Standards  
DB00671

## FCC/IC NOTICE

**Model: DS126621 (including WLAN Module Model ES200, FCC ID: AZD230/ IC: 498J-230)**

This device complies with Part 15 of FCC Rules and Industry Canada's licence-exempt RSSs. Operation is subject to the following two conditions:

- (1) this device may not cause harmful interference, and
- (2) this device must accept any interference received, including interference that may cause undesired operation.

This transmitter must not be co-located or operated in conjunction with any other antenna or transmitter except Canon accessories supplied or designated for this product.

The available scientific evidence does not show that any health problems are associated with using low power wireless devices. There is no proof, however, that these low power wireless devices are absolutely safe. Low power Wireless devices emit low levels of radio frequency energy (RF) in the microwave range while being used. Whereas high levels of RF can produce health effects (by heating tissue), exposure of low-level RF that does not produce heating effects causes no known adverse health effects. Many studies of low-level RF exposures have not found any biological effects. Some studies have suggested that some biological effects might occur, but such findings have not been confirmed by additional research. This model has been tested and found to comply with FCC/IC radiation exposure limits set forth for an uncontrolled environment and meets the FCC radio frequency (RF) Exposure Guidelines and RSS-102 of the IC radio frequency (RF) Exposure rules.

---

Hereby, Canon Inc., declares that this DS126621 is in compliance with the essential requirements and other relevant provisions of Directive 1999/5/EC.

Please contact the following address for the original Declaration of Conformity:

**CANON EUROPA N.V.**

Bovenkerkerweg 59, 1185 XB Amstelveen, The Netherlands

**CANON INC.**

30-2, Shimomaruko 3-chome, Ohta-ku, Tokyo 146-8501, Japan



## Trademarks

- Microsoft and Windows are trademarks or registered trademarks of Microsoft Corporation in the United States and/or other countries.
- Macintosh and Mac OS are trademarks of Apple Inc., registered in the U.S. and other countries.
- The Wi-Fi CERTIFIED logo and the Wi-Fi Protected Setup mark are trademarks of the Wi-Fi Alliance.
- WPS used on camera settings screens and in this manual stands for Wi-Fi Protected Setup.
- UPnP is a trademark of the UPnP Implementers Corporation.
- The N-Mark is a trademark or registered trademark of NFC Forum, Inc. in the United States and in other countries.
- All other trademarks are the property of their respective owners.

# Index

---

## A

Android..... W-16

## C

Cable..... W-13

Camera Connect..... W-16, W-26

Connect Station..... W-35

Connecting to a smartphone..... W-17

## E

Eye-Fi Card..... W-13

## I

iOS..... W-16

## K

Keyboard..... W-10

## N

NFC..... W-14, W-18, W-19, W-36

    Sending images..... W-30

Nickname ..... W-8

## R

Reconnecting ..... W-28

Reducing the image size..... W-33

Remote shooting..... W-26

## S

Sending images ..... W-30

## V

Viewing images..... W-26















The descriptions in this Instruction Manual are current as of February 2016. For information on the compatibility with any products introduced after this date, contact any Canon Service Center. For the latest version Instruction Manual, refer to the Canon Web site.