

# Champion®

## CONTRACTOR™



### 135L CEMENT MIXER

MODEL NO: CCM135

PART NO: 3400865

## OPERATION & MAINTENANCE INSTRUCTIONS



ORIGINAL INSTRUCTIONS

DL1024 Rev 2

---

## INTRODUCTION

---

Thank you for purchasing this CLARKE Cement Mixer.

Before attempting to use this product, please read this manual thoroughly and follow the instructions carefully. In doing so you will ensure the safety of yourself and that of others around you, and you can look forward to your purchase giving you long and satisfactory service.

---

## SPECIFICATION

---

Model No	CCM135
Max drum capacity	135 Litre
Max mixing capacity	100 Litre
Drum speed	25 rpm
Duty cycle classification	S6 30%
Drum turning axis	360°
Weight	43.5 kg
Dimensions: Length x Width x Height	1180 x 713 x 1300 mm
Operating voltage & frequency	230V-50Hz
Rated input wattage	485W
Rated input ampere	2.44A
Power cable length	0.3 m
IP rating	IP44D
Sound power guaranteed	91 dB LWA

---

## GUARANTEE

---

This product is guaranteed against faulty manufacture for a period of 12 months from the date of purchase. Please keep your receipt which will be required as proof of purchase.

This guarantee is invalid if the product is found to have been abused or tampered with in any way, or not used for the purpose for which it was intended. Faulty goods should be returned to their place of purchase, no product can be returned to us without prior permission.

This guarantee does not effect your statutory rights.

---

## GENERAL SAFETY PRECAUTIONS

---

1. **ALWAYS** keep the work area clean and well lit. Floors should always be kept clear. Cluttered or dark areas invite accidents.
2. **ALWAYS** keep children and bystanders away while operating this machine. Distractions can cause loss of control.
3. **ALWAYS** stay alert & do not use a machine while you are tired or under the influence of medication or alcohol.
4. **ALWAYS** wear suitable protective clothing and eye protection including industrial gloves, ear defenders & approved impact resistant safety glasses. (Eye glasses are NOT safety glasses). Wear a dust mask if handling cement.
5. **NEVER** over-reach. Keep your proper footing and balance at all times to enable better control of the machine in unexpected situations.
6. **NEVER** stand on the machine. Injury could occur from a fall.
7. **ALWAYS** store machines out of reach of children.
8. **ALWAYS** read and become familiar with the entire operating manual.
9. **NEVER** allow persons unfamiliar with this manual to operate this machine.
10. **ALWAYS** maintain the machine with care and keep it clean for best / safest performance.
11. **NEVER** use this machine if any part is damaged. Have it inspected and repaired by a competent technician.
12. **NEVER** modify this machine in any way. Use it only for the purpose for which it is designed.
13. **ALWAYS** ensure the electrical cable is fully protected and there is no danger of damage from equipment or materials. Always inspect the cable before use and replace if any damage is apparent.
14. **ALWAYS** avoid inhaling cement dust while loading the mixer. Avoid contact with cement or any mixing additives being used. Wear gloves/face mask if necessary.
15. **ALWAYS** disconnect the machine from the power supply when not in use, and before carrying out any maintenance.
16. **NEVER** leave the machine running unattended or leave the machine until it comes to a complete stop.
17. **ALWAYS** keep your hands well clear of the rotating drum at all times. Never put your hands inside the drum when the machine is switched on.
18. **NEVER** put any tools or other objects in or around the drum while it is rotating.

19. **NEVER** wear jewellery or loose clothing that could be snagged by any part of the rotating drum.
20. **NEVER** load the drum when the machine is switched off. Always switch on and ensure the drum is rotating before loading.
21. **NEVER** operate this machine on a gradient. Always stand the mixer on firm, level ground where it cannot tip over.
22. **ALWAYS** switch off and disconnect from the power supply before moving the machine around the work site.
23. **NEVER** use the mixer if the power cable or other important parts of the machine are damaged.
24. If an extension cable is used, the cable and plug must be of watertight construction. Inadequate extension cables can be dangerous.

---

## **ENVIRONMENTAL RECYCLING POLICY**

















---

By purchasing this product, the customer is taking on the obligation to deal with its safe disposal in accordance with the Waste Electrical and Electronic Equipment (WEEE).

This means that this product must not be disposed of with general household waste. It must be disposed of according to the laws governing Waste Electrical and Electronic Equipment (WEEE) at a recognised disposal facility.

If disposing of this product or any damaged components, do not dispose of with general waste. This product contains valuable raw materials. Metal products should be taken to your local civic amenity site for recycling of metal products.

# SAFETY SYMBOLS DISPLAYED ON THE MACHINE

	Read instruction manual before use.		Wear eye protection.
	Wear protective gloves.		Wear protective footwear.
	Wear ear protection.		Protect the environment when emptying.
	Do not use where the mixer could tip over.		Keep bystanders at a safe distance.
	Do not operate on sloping ground.		Always disconnect the power before starting any maintenance or cleaning.
	Do not insert anything into the drum while the mixer is running.		Do not remove or tamper with any protection or safety device.
	Do not remove drive guard with power connected.		Do not overload the mixer.
	Pinch point hazard. Do not insert fingers or other objects.		Keep hands clear of the machine when running.

---

# ELECTRICAL CONNECTIONS

---



**WARNING: READ THESE ELECTRICAL SAFETY INSTRUCTIONS THOROUGHLY BEFORE CONNECTING THE PRODUCT TO THE MAINS SUPPLY.**

Connect the mains lead to a standard, 230 Volt (50Hz) electrical supply through an approved 13 amp BS1363 plug, or a suitably fused isolator switch.

If the plug has to be changed because it is not suitable for your socket or because of damage, it must be removed and a replacement fitted, following the wiring instructions shown below. The old plug must be discarded safely as insertion into a power socket could cause an electrical hazard.



**WARNING: THE WIRES IN THE POWER CABLE OF THIS PRODUCT ARE COLOURED IN ACCORDANCE WITH THE FOLLOWING CODE: BLUE = NEUTRAL BROWN = LIVE**

The wires in the mains lead should be wired up in accordance with the following colour code:

- Connect the BROWN coloured wire to the plug terminal marked with a letter "L".
- Connect the BLUE coloured wire to the plug terminal marked with a letter "N".

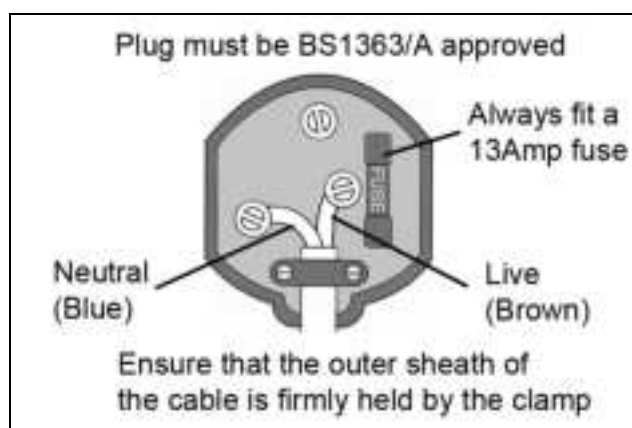

We strongly recommend that this machine is connected to the mains supply via a Residual Current Device (RCD). If you are not sure, consult a qualified electrician.

DO NOT try to carry out any repairs yourself.



This symbol indicates that this is a Class II product and does not require an earth connection.

# UNPACKING & ASSEMBLY

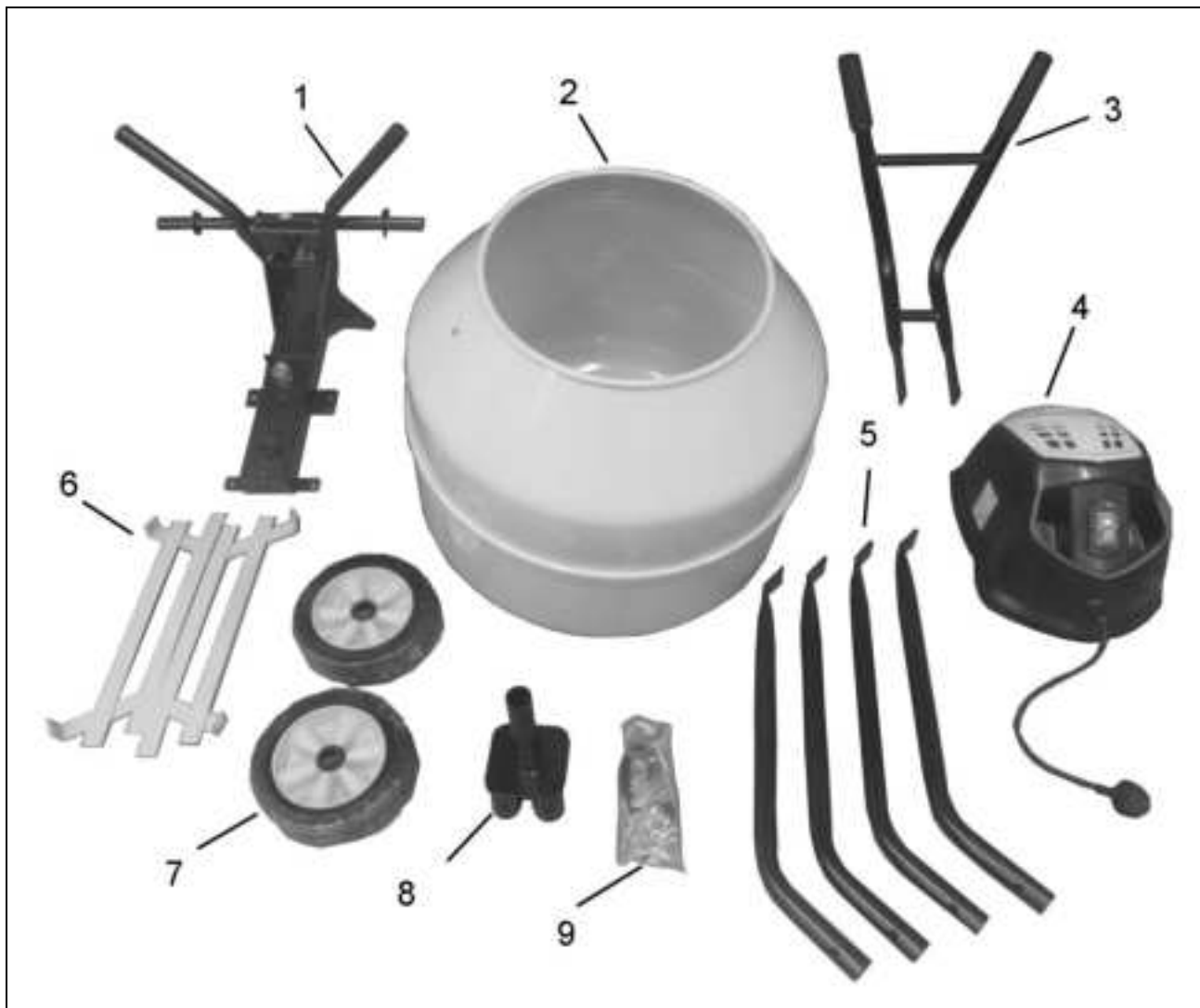

Remove all components from the packing case and lay them out so that they can be identified and checked for any possible damage during transit. Should any component be found to be damaged or missing, please contact your CLARKE dealer immediately. Check the components against the following list.

1. Stand Assembly	6. Mixing blades
2. Drum assembly	7. Wheels
3. Handlebars	8. Stand Connector
4. Drive motor assembly	9. Fixings Kit (bolts/nuts/washers/pins R-clips/split pins/locking pin & chain.)
5. Stand Legs	

# ASSEMBLY

1. Bolt the mixing blades to the mixing drum using by inserting the cross headed screws from the outside through the holes in the drum.
2. Place a leather washer inside between the drum and blade and secure the mixing blade from the inside using a flat washer, lock washer and nut.
3. Bolt the protective plastic drive guard to the frame using the small (M6x20) bolts, washers and locknuts.
4. If not already fitted for shipping, bolt the metal drive gear guard to the back of the drum.
5. Bolt the drum to the frame with the M12x30 bolt with locknut and washer.
6. Attach the drive motor assembly to the frame. Line up the flat side of the drive shaft and slide the transmission over the shaft.
7. Secure in place using an M8 nut with flat washer on each of the four captive bolts protruding from the drive assembly.
8. Bolt the handles to the main frame using the nuts & bolts and flat washers supplied.

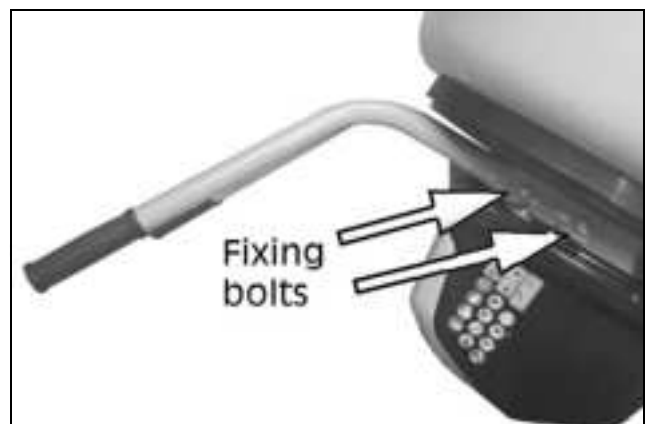
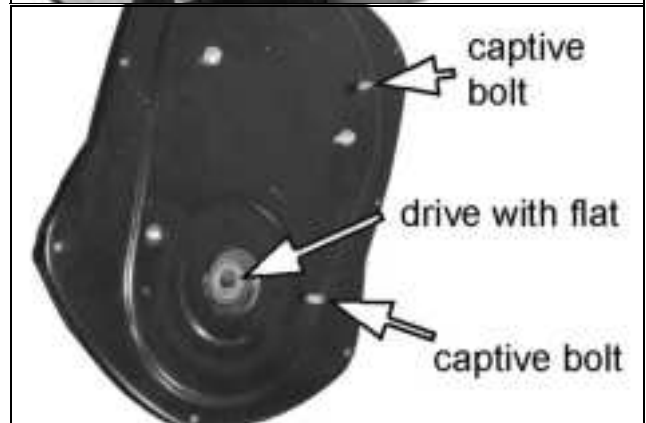
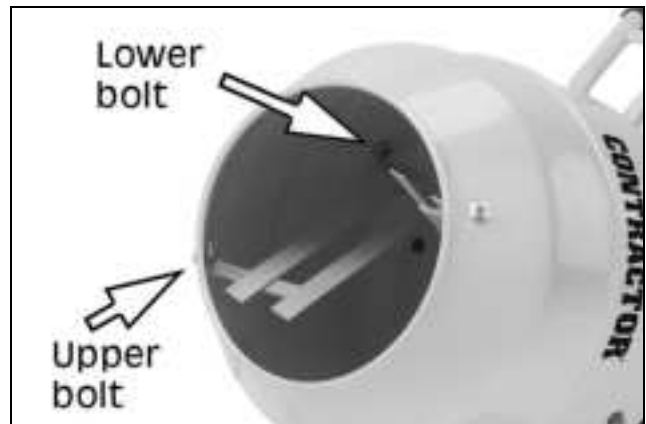

9. Tip the assembly over and slide the wheels onto each of the axles securing them with the large washers and cotter pins supplied.

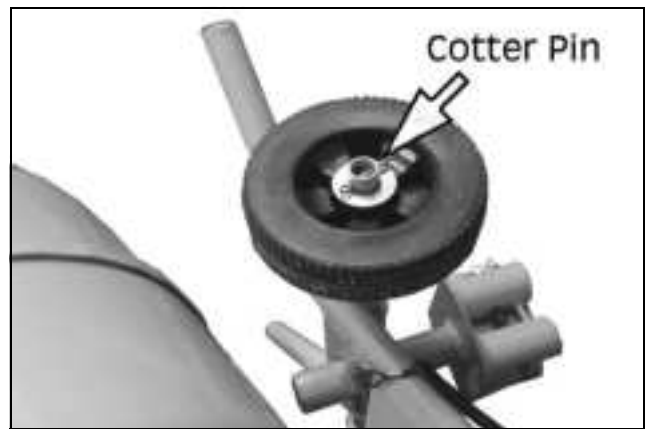

10. Assemble the stand by sliding the four legs into the stand connector. Fasten in place with the pins and R-clips provided.

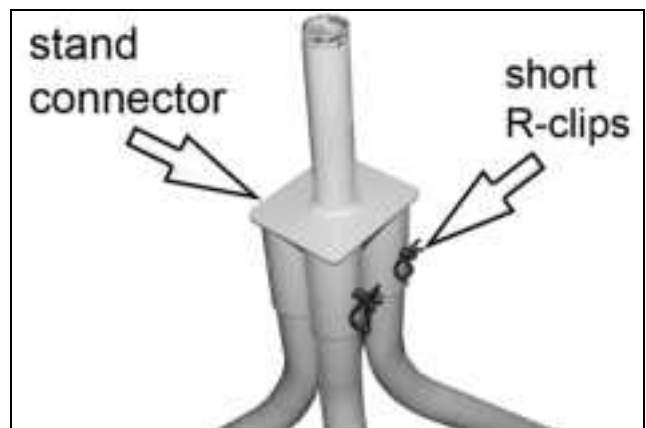

11. Lift and locate the cement mixer onto the stand.
- The assistance of another person will be required to do this.



## OPERATION

1. Switch the mixer on by pressing the green (I) switch on the motor. Stop by pressing the red (O) switch.
2. Introduce water first, to prevent the mixer from clogging.
3. Add cement as required.
4. Add aggregate to suit.
  - Do not load the drum when the machine is switched off. Always set the machine running before filling.
  - Avoid stopping and starting the mixer while there is a heavy weight of material inside the drum as the extra strain could be harmful to the motor.
  - Keep the drum rotating while emptying the mixture.
5. When emptying, remove the locking pin and tilt the mixer forward while gripping both handles tightly.
  - Only discharge the mixer when a suitable receptacle for the cement mix is in position.
  - Do not operate this machine on a steep gradient. Always stand the mixer on firm, level ground where it cannot tip over.

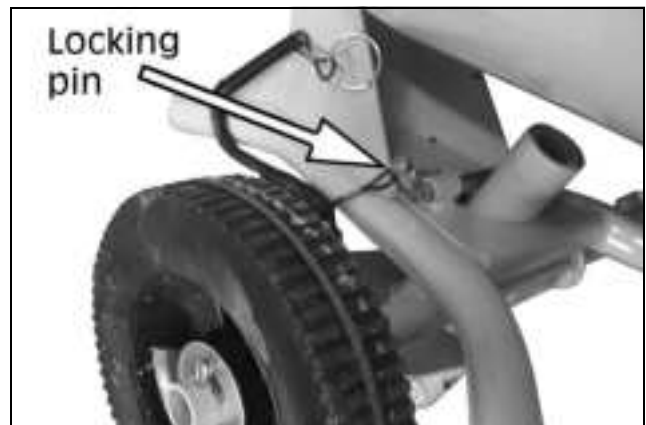

**WARNING: REMEMBER THAT THE CENTRE OF GRAVITY OF THE LOADED MIXER MAY PRESENT A HAZARD WHEN OPERATING ON UNEVEN GROUND.**

- Always keep water away from the motor and other electrical components as far as possible.

It is essential that the mixer is kept clean. Dried cement inside the drum will be very difficult to remove. For the mixer to perform at its best it must be thoroughly cleaned after every use.

---

# CARE AND MAINTENANCE

---

## AFTER USE

At the end of the working shift it is essential that the machine is hosed down thoroughly with clean water, being sure to remove all traces of the cement mix especially from around the mixing blades. The drum may be scoured for a couple of minutes running using coarse gravel and water which is then discharged and the drum finally hosed clean.

Never allow cement residue to harden inside the drum and thereafter be tempted to beat on the drum with hand tools to dislodge such accumulations of dried cement.

The machine is constructed to IP44D ingress protection which enables the drum and any other areas to be hosed down safely. However, the motor and plug should not be hosed directly under pressure.

## STORAGE



CAUTION: OWING TO THE WEIGHT AND BULK OF THE MIXER, TWO PEOPLE WILL BE REQUIRED TO LOWER THE MIXER AND RE-FIT THE BOLTS.

The mixer can be better stored with the support stand folded away.

Remove and lower the mixer to the floor with the help of an assistant. Loosely re-fit the pins and R-clips into their respective holes for safe keeping.

Leave the mixer with the drum partially inverted to exclude water or debris and always store the mixer in a dry place out of reach of children.

## OCCASIONALLY

After extensive use, inspect the paint and remove any rust that may be apparent before touching up where necessary with a rust resistant paint.

## MAINTENANCE FREE ITEMS

The bearings in the machine are sealed for life and require no maintenance. The drive belt is under constant tension and therefore no adjustment is required.



# COMPONENT PARTS

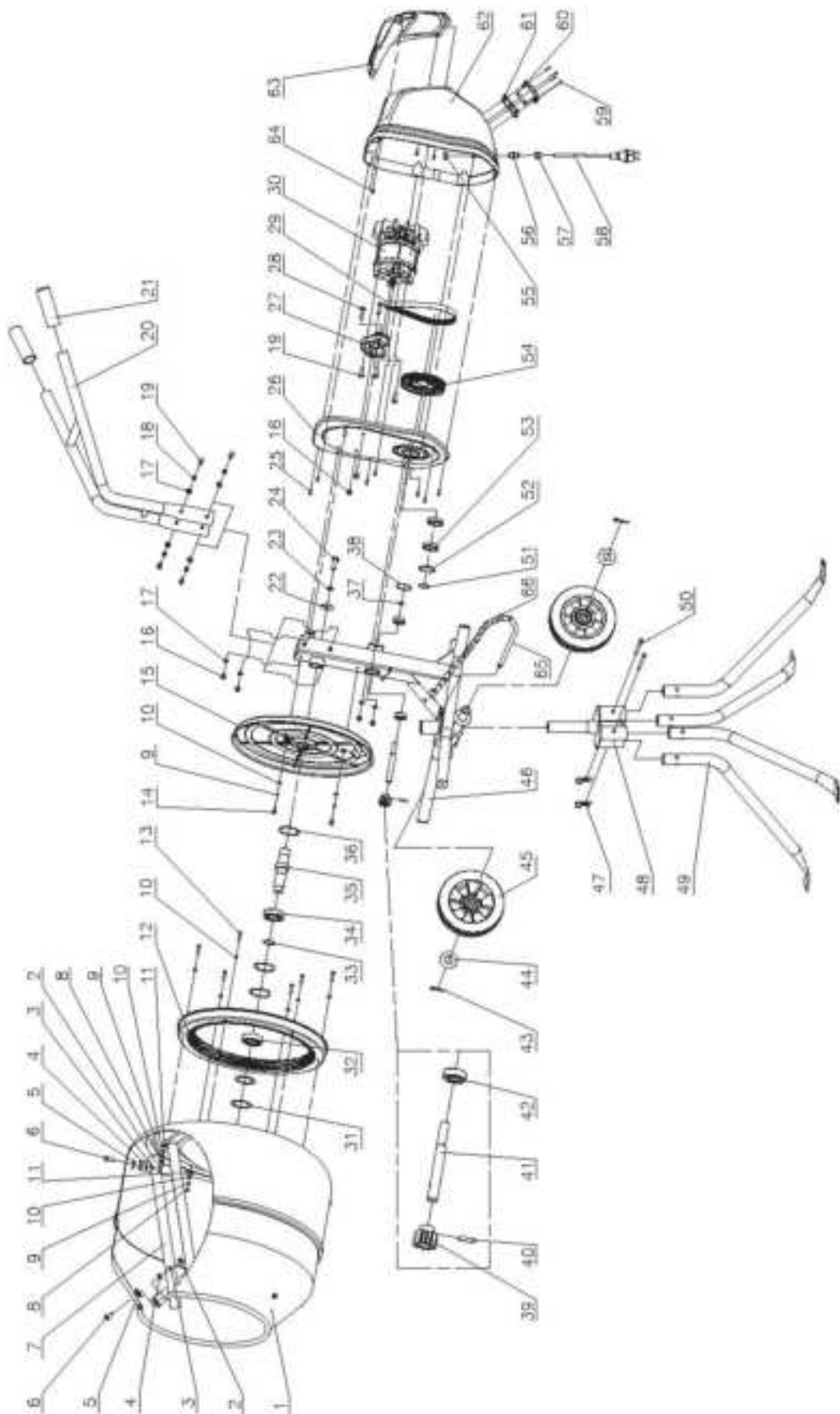

# COMPONENT PARTS LIST

ID	DESCRIPTION
1	Drum
2	Nut M10
3	Spring washer M10
4	Washer 10
5	Leather washer 10mm
6	Screw M10 x 25
7	Mixing blade
8	Nut M6
9	Spring washer 6
10	Washer 6
11	Leather washer 6
12	Gearwheel
13	Bolt M6 x 25
14	Bolt M6 x 20
15	Plastic rotator disc
16	Locknut M8
17	Washer 8
18	Spring washer 8
19	Bolt M8 x 25
20	Handle
21	Handle grip 32 dia
22	Washer
23	Spring washer 12
24	Bolt M12 x 30
25	ST screw
26	Motor end plate
27	Motor seat
28	Bolt M8 x 30
29	Drive belt 6PJ-L540
30	Motor
31	Adjusting washer
32	Bearing 6305-2RS
33	Circlip 30

ID	DESCRIPTION
34	Bearing 6206-2RS
35	Drum rotating shaft
36	Circlip 62
37	Circlip 15
38	O-ring
39	Drive pinion
40	Pin 6 x 25
41	Drive
42	Bearing 6202-2RS
43	Cotter pin 5 x 40
44	Flat washer
45	Wheel
46	Frame
47	R-clip
48	Leg connecting bracket
49	Support leg
50	Pin
51	Wire snap ring
52	Circlip
53	Bearing 61906-2RS
54	Drive pulley
55	Nut
56	Bolt
57	Locknut
58	Power cable & plug
59	ST screw
60	Switch
61	Switch seal
62	Motor cover
63	Decorative cover
64	ST screw
65	Tilt locating pin
66	Pin securing chain

# DECLARATIONS OF CONFORMITY-UK

**UK  
CA**

**Clarke<sup>®</sup>**  
**INTERNATIONAL**  
Hemond Street, Epping, Essex CM19 4LG

## DECLARATION OF CONFORMITY

This is an important document and should be retained.

**Product Description:** Cement Mixer  
**Model number(s):** CCM135  
**Serial / batch Number:** N/A  
**Date of issue:** 28/07/2022  
**(Noise Conformity)**  
**Notified Body:** N/A

**Technical Documentation Holder:** A.R. Ford  
Clarke International  
2a Strudland Road  
Lewden E10 7RB  
UK

**Conformity Assessment Procedure:** In 2000/14/EC Annex V  
**Manufacturer:** Clarke International  
**Noise Rated Value:** 0.1 m<sup>3</sup>  
**Measured Sound Power Level:** 90 dB  
**Guaranteed Sound Power Level:** 91 dB

CCM135 UKCA Decl DOC 07022

Page 1 of 2

**UK  
CA**

**Clarke<sup>®</sup>**  
**INTERNATIONAL**  
Hemond Street, Epping, Essex CM19 4LG

## DECLARATION OF CONFORMITY

This is an important document and should be retained.

We hereby declare that this product(s) complies with the following statutory requirement(s):  
**Electromagnetic Compatibility Regulations 2016**  
**Supply of Machinery (Safety) Regulations 2008**  
**Noise Emission in the Environment by Equipment for use Outdoors Regulations 2001**  
**The Restriction of the Use of Certain Hazardous Substances in Electrical and Electronic Equipment Regulations 2012**

The following standards have been applied to the product(s):  
EN 55014-1:2006+A1+A2, EN 55014-2:2017, EN 55014-2:2015, EN 61000-3-2:2014,  
EN 61000-3-3:2013, EN 60204-1:2009+A1:2009+AC:2010, EN 12187:2007, EN ISO 11201:1995,  
IEC 62321-4:2014, IEC 62321-3:2013, IEC 62321-6:2015, IEC 62321-5-1:2015,  
IEC 62321-5-2:2017, IEC 62321-8:2017

The technical documentation required to demonstrate that the product(s) meet(s) the requirement(s) of the aforementioned legislation has been compiled and is available for inspection by the relevant enforcement authorities.

The UKCA mark was first applied to: 3022

Signed:



J.A. Clarke  
Director

CCM135 UKCA Decl DOC 07022

Page 1 of 2

# DECLARATIONS OF CONFORMITY-EU

CE

**Clarke**  
INTERNATIONAL  
Fitzwilliam Hall, Fitzwilliam Place, Dublin 2

## DECLARATION OF CONFORMITY

This is an important document and should be retained.

Product Description: Cement Mixer  
Model number(s): CCM135  
Serial / batch Number: N/A  
Date of Issue: 28/07/2022  
(Noise Conformity)  
Notified Body: N/A

### Technical Documentation Holder:

A.R. Pond  
Clarke International  
2a Strutton Road  
London E10 7NB  
UK

### Conformity Assessment Procedure: to 2000/4/EC Annex V

Manufacturer: Clarke International  
Noise Related Value: 0.1 m<sup>2</sup>  
Measured Sound Power Level: 86 dB  
Guaranteed Sound Power Level: 91 dB

CCM135 CE Declaration

Page 1 of 2

CE

**Clarke**  
INTERNATIONAL  
Fitzwilliam Hall, Fitzwilliam Place, Dublin 2

## DECLARATION OF CONFORMITY

This is an important document and should be retained.

We hereby declare that this product(s) complies with the following directive(s):

2014/53/EU / Electromagnetic Compatibility Directive  
2006/42/EC Machinery Directive  
2005/14/EC Outdoor Noise Directive  
2011/65/EU Restriction of the Use of Certain Hazardous Substances in Electrical and Electronic Equipment Directive

The following standards have been applied to the product(s):

EN 50144-1:2006+A1+A3, EN 55014-1:2017, EN 55014-2:2015, EN 61000-3-2:2014,  
EN 61000-3-3:2013, EN 60334-1:2006+A1:2009+AC:2010, EN 62181:2007, EN ISO 11301-1:2005,  
IEC 62321-4:2014, IEC 62321-5:2013, IEC 62321-6:2015, IEC 62321-7-1:2015,  
IEC 62321-7-2:2017, IEC 62321-8:2017

The technical documentation required to demonstrate that the product(s) meet(s) the requirement(s) of the aforementioned directive(s) has been compiled and is available for inspection by the relevant enforcement authorities.

The CE mark was first applied in: 2022

Signed:



J.A. Clarke  
Director

CCM135 CE Declaration

Page 1 of 2

## A SELECTION FROM THE VAST RANGE OF

# Clarke®

## QUALITY PRODUCTS



**AIR COMPRESSORS**  
From DIY to industrial, Plus air tools,  
spray guns and accessories.

**GENERATORS**  
Prime duty or emergency standby  
for business, home and leisure.

**POWER WASHERS**  
Hot and cold, electric and engine  
driven - we have what you need

**WELDERS**  
Mig, Arc, Tig and Spot.  
From DIY to auto/industrial.

**METALWORKING**  
Drills, grinders and saws for DIY  
and professional use.

**WOODWORKING**  
Saws, sanders, lathes, mortisers  
and dust extraction.

**HYDRAULICS**  
Cranes, body repair kits,  
transmission jacks for all types of  
workshop use.

**WATER PUMPS**  
Submersible, electric and engine driven  
for DIY, agriculture and industry.

**POWER TOOLS**  
Angle grinders, cordless drill sets,  
saws and sanders.

**STARTERS/CHARGERS**  
All sizes for car and commercial use.



# PARTS & SERVICE: 0208 988 7400

**Parts Enquiries**  
[Parts@clarkeinternational.com](mailto:Parts@clarkeinternational.com)

**Servicing & Technical Enquiries**  
[Service@clarkeinternational.com](mailto:Service@clarkeinternational.com)

SALES: UK 01992 565333 or Export 00 44 (0)1992 565335

**Clarke** INTERNATIONAL Hemnall Street, Epping, Essex CM16 4LG  
[www.clarkeinternational.com](http://www.clarkeinternational.com)