

ENGINEERING  
TOMORROW



Operating Guide

# TechCase iC7

230 V Mains





# Contents

## 1 Introduction

1.1 Purpose of this Operating Guide	5
1.2 Version History	5
1.3 Additional Resources	5
1.4 Abbreviations	5
1.5 Recommended Disposal	5

## 2 Safety

2.1 Target Group and Necessary Qualifications	7
2.2 Safety Symbols	7
2.3 General Safety Considerations	7
2.4 Designated Use	8
2.5 Safe Operation	9

## 3 Overview

3.1 TechCase iC7	10
3.2 Contents of the Delivery	10
3.3 Functionality	11
3.4 Interface	12
3.5 Control Panel of the Frequency Converter	13
3.6 Standard I/O Panel	13
3.7 Software	13
3.8 Storage	14

## 4 Installation

4.1 Installation Considerations	15
4.2 Connecting the 230 V Supply	15
4.3 Connecting an External 24 V DC Supply	15
4.4 Connecting an External Motor	15
4.5 Connecting an Encoder	15
4.6 Connecting the Standard I/O Panel	16
4.7 Connecting Extra I/Os	16
4.8 Connecting Ethernet Cables	16

---

4.9	Connecting Cases in Series	16
<hr/>		
<b>5</b>	<b>Operation</b>	
5.1	Operation Considerations	17
5.2	Starting Up	17
5.3	Stopping the Device	18
5.4	Reset to Factory Default Settings	18
<hr/>		
<b>6</b>	<b>Fault Tracing</b>	
6.1	Status of the AC Drive	19
6.2	Troubleshooting	19
6.2.1	Issues with Software	19
6.2.2	Problems with Internal/External Motor	19
6.2.3	The Case does not Power Up	19
6.2.4	Drive does not Start Up	19
6.2.5	RCD Trip	20
6.2.6	Broken Device	20
<hr/>		
<b>7</b>	<b>Specifications</b>	
7.1	Wiring Diagram	21
7.2	Technical Data	21

---

# 1 Introduction

## 1.1 Purpose of this Operating Guide

This operating guide provides information for safe installation and commissioning of the product. It is intended for use by qualified personnel. To use the drive safely and professionally, read and follow the instructions. Pay particular attention to the safety instructions and general warnings.

## 1.2 Version History

This guide is regularly reviewed and updated. All suggestions for improvement are welcome.

Find the latest version of this guide at <https://www.danfoss.com>.

The original language of this guide is English.

Table 1: Version History

Version	Remarks
A	The 1st version of this guide.
B	Updated the guide to match the updated version of the TechCase iC7.

## 1.3 Additional Resources

Other resources are available to understand advanced functions and operation of the product.

- iC7 Series Frequency Converters Installation Safety Guide
- iC7-Automation Frequency Converters Design Guide
- iC7 Series Industry Application Guide

Supplementary publications and manuals are available at <https://www.danfoss.com/en/service-and-support/documentation/>.

## 1.4 Abbreviations

Table 2: Abbreviations, Acronyms, and Symbols

Term	Definition
AC	Alternating current
DC	Direct current
EMC	Electromagnetic compatibility
I/O	Input/output
PE	Protective earth
RCD	Residual-current device

## 1.5 Recommended Disposal

When the product reaches the end of its service life, its primary components can be recycled.

Before the materials can be removed, the product must be disassembled. Product parts and materials can be dismantled and separated. Generally, all metals, such as steel, aluminum, copper and its alloys, and precious metals can be recycled as material. Plastics, rubber, and cardboard can be used in energy recovery. Printed circuit boards and large electrolytic capacitors with a diameter of under 2.5 cm (1 in) need further treatment according to IEC 62635 guidelines. To ease recycling, plastic parts are marked with an appropriate identification code.

Contact your local Danfoss office for further information on environmental aspects and recycling instructions for professional recyclers. End-of-life treatment must follow international and local regulations.

All products are designed and manufactured in accordance with Danfoss company guidelines on prohibited and restricted substances. A list of these substances is available at <https://www.danfoss.com>.



This symbol on the product indicates that it must not be disposed of as household waste. Do not dispose of equipment containing electrical components together with domestic waste.

It must be handed over to the applicable take-back scheme for the recycling of electrical and electronic equipment.

- Dispose of the product through channels provided for this purpose.
  - Comply with all local and currently applicable laws and regulations.
-

## 2 Safety

### 2.1 Target Group and Necessary Qualifications

Correct and reliable transport, storage, installation, operation, and maintenance are required for the trouble-free and safe operation of the products. Only qualified personnel are allowed to perform all related activities for these tasks. Qualified personnel are defined as properly trained staff, who are familiar with and authorized to install, commission, and maintain equipment, systems, and circuits in accordance with pertinent laws and regulations. Also, the qualified personnel must be familiar with the instructions and safety measures described in this guide and other relevant guides. Non-qualified electricians are not allowed to perform any electrical installation or troubleshooting activities.



Only Danfoss authorized, qualified personnel are allowed to repair this equipment. Specialized training is required to perform the activities related to repair.

### 2.2 Safety Symbols

The following symbols are used in Danfoss documentation.

 <b>DANGER</b>
Indicates a hazardous situation which, if not avoided, will result in death or serious injury.
 <b>WARNING</b>
Indicates a hazardous situation which, if not avoided, could result in death or serious injury.
 <b>CAUTION</b>
Indicates a hazardous situation which, if not avoided, could result in minor or moderate injury.
<b>NOTICE</b>
Indicates information considered important, but not hazard-related (for example, messages relating to property damage).

The guide also includes ISO warning symbols related to hot surfaces and burn hazard, high voltage and electrical shock, and referring to the instructions.

	ISO warning symbol for hot surfaces and burn hazard
	ISO warning symbol for high voltage and electrical shock
	ISO action symbol for referring to the instructions

### 2.3 General Safety Considerations

**WARNING****LACK OF SAFETY AWARENESS**

This guide provides important information on preventing injury and damage to the equipment or the system. Ignoring this information can lead to death, serious injury, or severe damage to the equipment.

- Make sure to fully understand the dangers and safety measures present in the application.

**WARNING****ELECTRIC SHOCK**

Drives contain hazardous voltage when a power source is connected to AC or DC terminals. Failure to disconnect all power sources can result in death or serious injury.

- Before performing any electrical work on the drive, disconnect, lock out, and tag out all power sources to the drive.
- There is more than 1 live circuit. See the relevant wiring diagram in the product guide.

**WARNING****DISCHARGE TIME**

The drive contains capacitors, which can remain charged even when the drive is not powered. High voltage can be present even when the warning indicator lights are off.

Failure to wait the specified time after power has been removed before performing service or repair work could result in death or serious injury.

- Stop the drive.
- Disconnect all input and output power sources of the drive (for example permanent magnet type motors, batteries, or DC-link connections to other drives).
- Wait for the capacitors to discharge fully before performing any service on the equipment. The discharge time is 5 minutes. If the device is broken or fuses have tripped, the discharge time is longer.
- Use a measuring device to make sure that there is no voltage, before opening the drive or performing any work on the cables.

**WARNING****UNINTENDED START**

When the drive is connected to a power source, the system may start at any time, causing risk of death, serious injury, and equipment or property damage.

- Stop the drive and motor before configuring parameters.
- Make sure that the drive cannot be started by an external switch, a fieldbus command, an input reference signal from the control panel, or after a cleared fault condition.
- Disconnect the drive from the power source whenever safety considerations make it necessary to avoid unintended start.
- Check that the drive, motor, and any driven equipment are in operational readiness.

## 2.4 Designated Use

Installing and operating a Danfoss product not following the following preconditions is regarded as non-designated use. Danfoss does not take any liability for non-designated use.

Danfoss products are units intended for installation in electrical systems. They comply with the requirements of various directives and certifications. To see all valid certifications for the product, check the product label.

When the product is installed in machinery or system, these have to comply with relevant national regulations.

In any case, the product and its components have to be operated in accordance with all national Occupational Safety & Health regulations and directives.

Operation of Danfoss products is only allowed under observance of the respective EMC regulations.

Operation of Danfoss products is only allowed under observance of the specifications and requirements given on the product label and in the product-specific documentation.

Only use spare parts approved and provided by Danfoss. Using other spare parts can damage the product.

## 2.5 Safe Operation

Before activating any automatic fault reset functions or change limit values, make sure that no dangerous situations can occur after restart. If the autoreset function is activated, the motor starts automatically after an automatic fault reset.

Keep all covers closed and terminal boxes screwed on during operation of the drive and when mains is connected.

Drive components and accessories can still be live and connected to mains, even after the operation indicators are no longer illuminated.

The drive contains DC-link capacitors, which can remain charged even when the drive is not powered. High voltage can be present even when the status indicator lights are off. Failure to wait the specified time after power has been removed before performing service or repair work could result in death or serious injury. To prevent dangerous situations:

- Stop the motor.
- Disconnect AC mains, permanent magnet type motors, and remote DC-link supplies, including battery backups, UPS, and DC-link connections to other drives.
- Wait for the capacitors to discharge fully before performing any service or repair work. Wait the specified discharge time before removing the touch covers. The discharge time is stated on the corresponding label on the drive and in the drive-related manuals.
- Use a measuring device to make sure that there is no voltage.

### 3 Overview

#### 3.1 TechCase iC7

The TechCase iC7 is an encased table test system with a 230 V supply.

The TechCase iC7 can be utilized in many use cases:

- Sales demonstrations
- Training
- Application support
- Technical support
- Personal learning

Order the TechCase iC7 from the Danfoss product store with sales code 141F7974.

#### 3.2 Contents of the Delivery

The TechCase iC7 is delivered in a cardboard box. The contents of the delivery are shown in [Figure 1](#).



Figure 1: Items Included in the Delivery

1	TechCase iC7	2	Supply cable (C14 to CEE 7/7)
3	Cable for the I/O panel	4	Standard I/O panel
5	Documentation (not shown)		

### 3.3 Functionality

TechCase iC7 includes an iC7-Automation Frequency Converter and an integrated induction motor (200–240 V, 26/35 W). There is also a terminal for connecting an external motor (230/400 V, 3.65/2.1 A).

The case requires a 1-phase 230 V input voltage and includes a daisy-chain socket to connect more cases. There are also terminals for external 24 V DC supply.

The case has an Emergency Stop function to separate the supply voltage from the frequency converter.

There are 3 Ethernet ports for:

- 2 x fieldbus
- PC

There are 2 D-type terminals for connecting:

- Operating panel
- Encoder for an external motor (optional, not available yet)

TechCase iC7 includes some features, which are related to options that are not available yet.

### 3.4 Interface

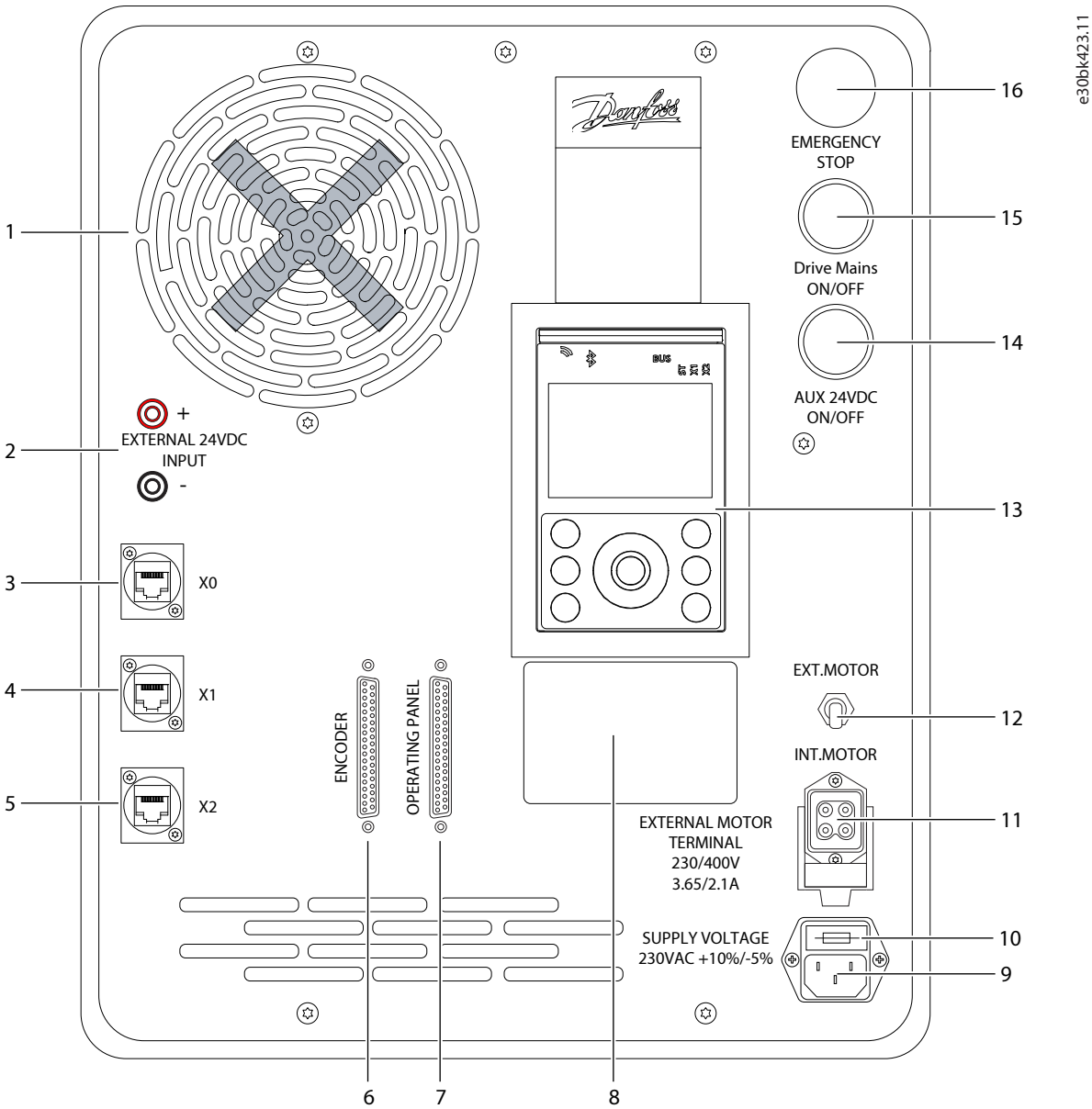

Figure 2: Interface of the TechCase iC7

1	Rotation indicator for integrated motor	2	External 24 V DC input terminals (4 mm safety sockets)
3	Ethernet port X0 for PC connection	4	Ethernet port X1 for Fieldbus connection
5	Ethernet port X2 for Fieldbus connection	6	Terminal for encoder extension (option not available yet)
7	Terminal for standard operating panel	8	Product label
9	Mains supply terminal, 1-phase, 230 V AC (C14 type connector)	10	6.3 A input fuses
11	Terminal for external motor (HAN 3A type connector)	12	Selection switch for internal/external motor
13	Control panel of the frequency converter	14	Auxiliary 24 V DC ON/OFF button
15	Drive mains ON/OFF button	16	Emergency Stop button

### 3.5 Control Panel of the Frequency Converter

The iC7-Automation Frequency Converter has a control panel, which is used to set up the drive parameters and monitor the drive status. For detailed information and instructions for using the control panel, see the *iC7 Series Industry Application Guide*.

### 3.6 Standard I/O Panel

The standard I/O panel is included in the TechCase iC7 delivery by default. The panel is connected to the case with the D-type cable, which is also included in the delivery.

The standard I/O panel includes:

- 2 potentiometers for analog inputs
- An analog meter for the analog output (range 0–20 mA)
- 6 dip switches with indication lights for digital inputs
- 6 indication lights for relays
- 2 dip switches and 3 indication lights for safety I/Os

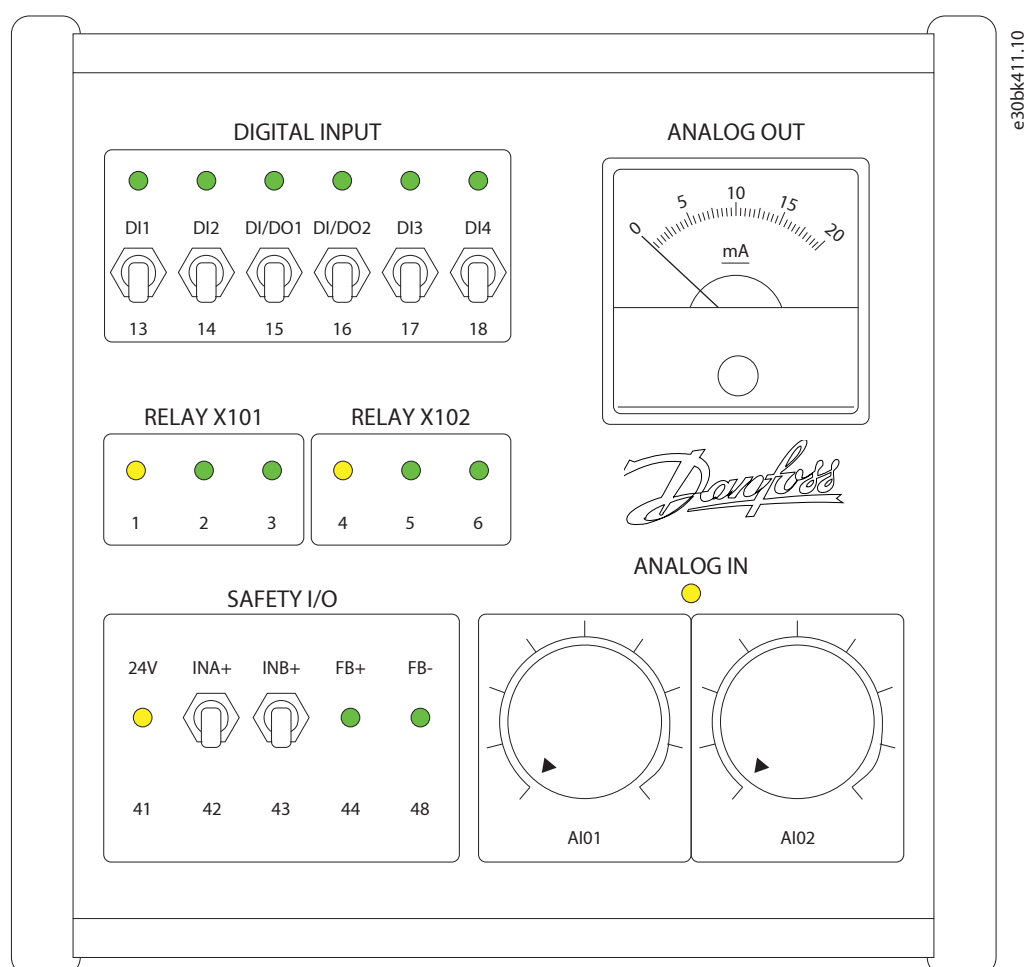

Figure 3: Interface of the Standard I/O Panel

### 3.7 Software

By default, the iC7-Automation Frequency Converter in the TechCase iC7 includes the iC7 Series Industry application software.

The latest version of the software is installed on the iC7-Automation Frequency Converter at the factory. There can still be a newer version of the software available. Check the commissioning report from of the drive, and if necessary, update the software.

Before updating the software on the iC7-Automation Frequency Converter, make sure that the software is compatible with the device. Do not install application software which is not compatible with the iC7-Automation Frequency Converter.

## 3.8 Storage

Follow these instructions for storing the TechCase iC7.

### Procedure

1. Make sure that the ambient conditions agree to the ones defined in [7.2 Technical Data](#).
2. Make sure that all parts are included in the case and that the cover is closed properly.
3. If the case is in storage for more than 2 months, keep it in controlled conditions.
  - a. Make sure that the temperature variation is small.
  - b. Make sure that the humidity is less than 50%.
4. If the case is in storage for more than 12 months, it is recommended to connect power to the drive.
  - a. Connect power to the drive.
  - b. Keep the power on for a minimum of 2 hours.
  - c. Disconnect the power.
  - d. Wait for the correct discharge time before removing the drive and storing it again.
5. If the case is in storage for several years, reform the capacitors to prevent damage to the capacitors.

Instructions for reforming the capacitors are available in the *iC7-Automation Frequency Converters Design Guide*.

## 4 Installation

### 4.1 Installation Considerations

Consider these before installing the TechCase iC7:

- Before starting the installation, read the safety instructions and follow them.
- Place the case on a level and even surface, so that it cannot fall down during installation.
- Remove the main cover of the case, but do not remove any other covers or dismantle the case.
- Only make connections to the terminals on the case. Do not change the wiring of the drive or the wiring inside the case.
- Push the Emergency Stop switch to the ON position before starting the installation.
- Complete all the electrical installations before supplying power to the case.

### 4.2 Connecting the 230 V Supply

The TechCase iC7 requires a 1-phase 230 V supply.

1. Connect the supply cable to the TechCase iC7.

The supply cable is delivered with the case. See [3.2 Contents of the Delivery](#).

The supply terminal is in the bottom right corner of the case. The connector type is C14. See [3.4 Interface](#).

2. Connect the supply cable to a 230 V power supply.

The supply cable has a CEE 7/7 connector.

### 4.3 Connecting an External 24 V DC Supply

An external 24 V DC supply can be connected to the TechCase iC7.

Requirements for the external 24 V supply:

- Output voltage: 24 V  $\pm$ 10%
- Minimum output current: 2 A

Connect the external 24 V supply to the case with 4 mm safety sockets. The supply terminals are on the front of the case. See [3.4 Interface](#).

If the TechCase iC7 has multiple power sources, this must be considered when operating the frequency converter. For information on the necessary safety precautions, refer to chapter 2 Safety in this guide and the *iC7 Series Frequency Converters Installation Safety Guide*.

### 4.4 Connecting an External Motor

An external motor with nominal supply voltage 230/400 V and current 3.65/2.1 A can be connected to the TechCase iC7. The terminal for connecting the external motor to the case is for a HAN 3A type connector.

See [3.4 Interface](#).

### 4.5 Connecting an Encoder

If an external motor is connected to the TechCase iC7, also an external encoder can be connected. A cable for the encoder connection is available as an option (the option is not available yet). The encoder cable has a male D-type connector in one end to connect to the case, and terminal blocks in the other end for encoder wiring.

See the location of the ENCODER terminal in [3.4 Interface](#).

## 4.6 Connecting the Standard I/O Panel

The standard I/O panel is connected to the TechCase iC7 with the D-type cable, which is included in the delivery.

The same cable can be used to connect the standard I/O panel and the optional advanced I/O panel.

Connect the standard I/O panel to the OPERATING PANEL terminal. See the locations of the terminals in [3.4 Interface](#).

In the I/O panel, the terminal is on the left side of the panel.

The D-type cable has a male connector in one end and a female connector in the other end. Connect the male connector to the case and the female connector to the I/O panel.

## 4.7 Connecting Extra I/Os

More analog and digital I/Os can be connected to the optional advanced I/O panel (the option is not available yet). The connections are done with 4 mm safety sockets.

## 4.8 Connecting Ethernet Cables

The TechCase iC7 has 3 built-in communication ports with RJ45 connectors:

- Ethernet ports X1 and X2 allow connections to fieldbus systems, with support for daisy chaining and single connections. The selected protocol is preconfigured. Modbus TCP is offered as standard, and other protocols such as PROFINET RT and EtherNet/IP are available either preinstalled, or alternatively, they can be activated later with a proof-of-purchase token. Safe Fieldbus protocols are also supported.
- Ethernet port X0 is available to connect to a PC or similar tools used for commissioning or service.
  - For instructions on using MyDrive® Insight, see the *iC7 Series Industry Application Guide*.

See the locations of the terminals in [3.4 Interface](#).

## 4.9 Connecting Cases in Series

TechCase iC7 units can be connected in series (daisy-chain connection). For instructions, see the *iC7-Automation Frequency Converters Design Guide*.

## 5 Operation

### 5.1 Operation Considerations

Consider these before operating the TechCase iC7:

1. Before powering up and operating the case, read the safety instructions and follow them.
2. Before use, check visually that the case and its contents are not broken in any way.
3. Make sure that the ambient conditions agree to the ones defined in [7.2 Technical Data](#).
4. Place the case on a level and even surface, so that it cannot fall down during operation.
5. Remove the main cover of the case, but do not remove any other covers or dismantle the case.
6. Do not power up the case if the cover of the case is on.
7. During operation, the case can be horizontal (interface pointing upwards) or vertical (interface pointing to one side).
8. Make sure that the cabling of the case is routed so that there is no risk of tripping on them.
9. Only keep the case powered up when using the case. Do not leave the case powered and unattended.
10. After use, replace the cover on the case and make sure it is fastened properly.

### 5.2 Starting Up

1. Finish the cabling to TechCase iC7. See the instructions in chapter 4 *Installation*.
2. Switch the *EMERGENCY STOP* button to the OFF position (pulled up).
3. Check that the selection switch for internal/external motor is in the correct position.
4. If the drive in the case has been reset to factory default settings, follow the instructions in [5.4 Reset to Factory Default Settings](#).
5. To switch on the mains supply, push the *ON* button.
6. Wait for the drive to start up.

 When the drive is started, it takes a moment for the drive to be in Ready state, and for the control panel display to change to the Home screen. The device is ready to use when the drive is in Ready state.

When the drive starts, an STO fault can be active. To disable the fault, switch down the SAFETY I/O switches INA+ and INB+ on the I/O panel.

7. Set the motor parameters for the internal or external motor.

If an external motor is used, check the motor parameter values from the motor nameplate.

**Table 3: Motor Parameters for the Internal Motor**

Index	Parameter name	Value	Unit
4.2.2.1	Nominal power	0.10	kW
4.2.2.2	Nominal current	1.0000	A
4.2.2.3	Nominal speed	2800	RPM
4.2.2.4	Nominal frequency	50.0	Hz
4.2.2.5	Nominal voltage	230.0	V

See the *iC7 Series Industry Application Guide* for instructions for using the control panel of the drive to set parameters and monitor the drive.

8. To control the inputs to TechCase iC7, use the I/O panel.

## 5.3 Stopping the Device

### NOTICE

#### EMERGENCY STOP

If there is an emergency, push the *EMERGENCY STOP* button to stop the device.

- Only use the *EMERGENCY STOP* if there is an emergency.

1. To switch off the mains supply, push the *OFF* button.
2. Wait for the drive to stop and power down.

When the drive is stopped, it takes a moment for the drive to power down. The light on the ON/OFF button is on for a while after stopping the drive.

### DANGER



#### DISCHARGE TIME

The drive contains capacitors, which can remain charged even when the drive is not powered. High voltage can be present even when the warning indicator lights are off.

Failure to wait the specified time after power has been removed before performing service or repair work could result in death or serious injury.

- Stop the system.
- Disconnect all inputs and outputs that can supply energy to the drive.
- Wait for the capacitors to discharge fully before performing any service on the equipment. The discharge time is 5 minutes. If the device is broken or fuses have tripped, the discharge time is longer.
- Use a measuring device to make sure that there is no voltage, before opening the drive or performing any work on the cables.

## 5.4 Reset to Factory Default Settings

### NOTICE

Switching the drive mains ON when the TechCase iC7 is reset to factory default settings can cause residual-current devices (RCD) to trip.

If the drive in the TechCase iC7 is reset to factory default settings:

- Do not turn ON the drive mains supply!
- Power up the case with an auxiliary 24 V supply.
- Use the control panel or the MyDrive® Insight PC tool to edit the following parameters:
  - Set parameter *2.2.1.5 Supply Mode* to *DC*.
  - Set parameter *1.2.2 RFI Filter Mode* to *Filter Inactive*.
- When the parameter settings are done, the drive mains can be switched ON.

## 6 Fault Tracing

### 6.1 Status of the AC Drive

The status indicators on the control panel show the status of the AC drive. If there is an active fault or warning, the event information can be found with the control panel, or with the PC tool, if a PC is connected to the TechCase iC7.

The status indicators and fault events are described in detail in the *iC7 Series Industry Application Guide*.

### 6.2 Troubleshooting

#### 6.2.1 Issues with Software

If there are any issues with the firmware or applications software:

- Check the version of the installed software and update if necessary.
  - Use the MyDrive® Insight PC tool to update the software.
  - For instructions how to connect a PC to the case, see [4.8 Connecting Ethernet Cables](#).
  - The drive must be powered up for the software installation.
- Make sure that the installed software is compatible with the drive.
  - Do not install application software which is not compatible with the iC7-Automation Frequency Converter.

#### 6.2.2 Problems with Internal/External Motor

If the internal or external motor does not rotate:

- Check that the selection switch for internal/external motor is in the correct position.
- Check that the motor parameter settings are correct.
- If using an external motor, make sure that the used motor is compatible with the TechCase iC7.
- If using an external motor, make sure that the connections are done correctly.

#### 6.2.3 The Case does not Power Up

If the TechCase iC7 does not power up when pushing the ON button:

- Check that the Emergency Stop button is in the OFF position.
- Check that the 230 V supply cable is connected correctly.
- Check the input fuses of the 230 V supply. See the location of the fuses in [3.4 Interface](#).
- Check that the wiring of the 230 V supply cable is correct and that the cable is not broken.

#### 6.2.4 Drive does not Start Up

If the drive in the TechCase iC7 does not start up when the case is turned on:

- Check the input fuses of the 230 V supply. See the location of the fuses in [3.4 Interface](#).
- Check that the wiring of the 230 V supply cable is correct and that the cable is not broken.
- Check the parameter settings of the drive. For details, see the *iC7 Series Industry Application Guide*.
- If the control panel on the drive is blank, disconnect the control panel, and reconnect it.
  - If the control panel stays blank, disconnect it and check the indicator lights on the drive under the panel. If the drive is in Ready state according to the indicator lights, the control panel is broken.
  - If the control panel is broken, contact Danfoss for ordering a new one.

## 6.2.5 RCD Trip

If residual-current devices (RCD) trip when the mains supply to the TechCase iC7 is switched ON, it can be caused by the case being reset to the factory default settings.

- Follow the instructions in [5.4 Reset to Factory Default Settings](#).

## 6.2.6 Broken Device

If the TechCase iC7 is broken:

- Contact Danfoss.
- Do not try to repair the device.

## 7 Specifications

### 7.1 Wiring Diagram

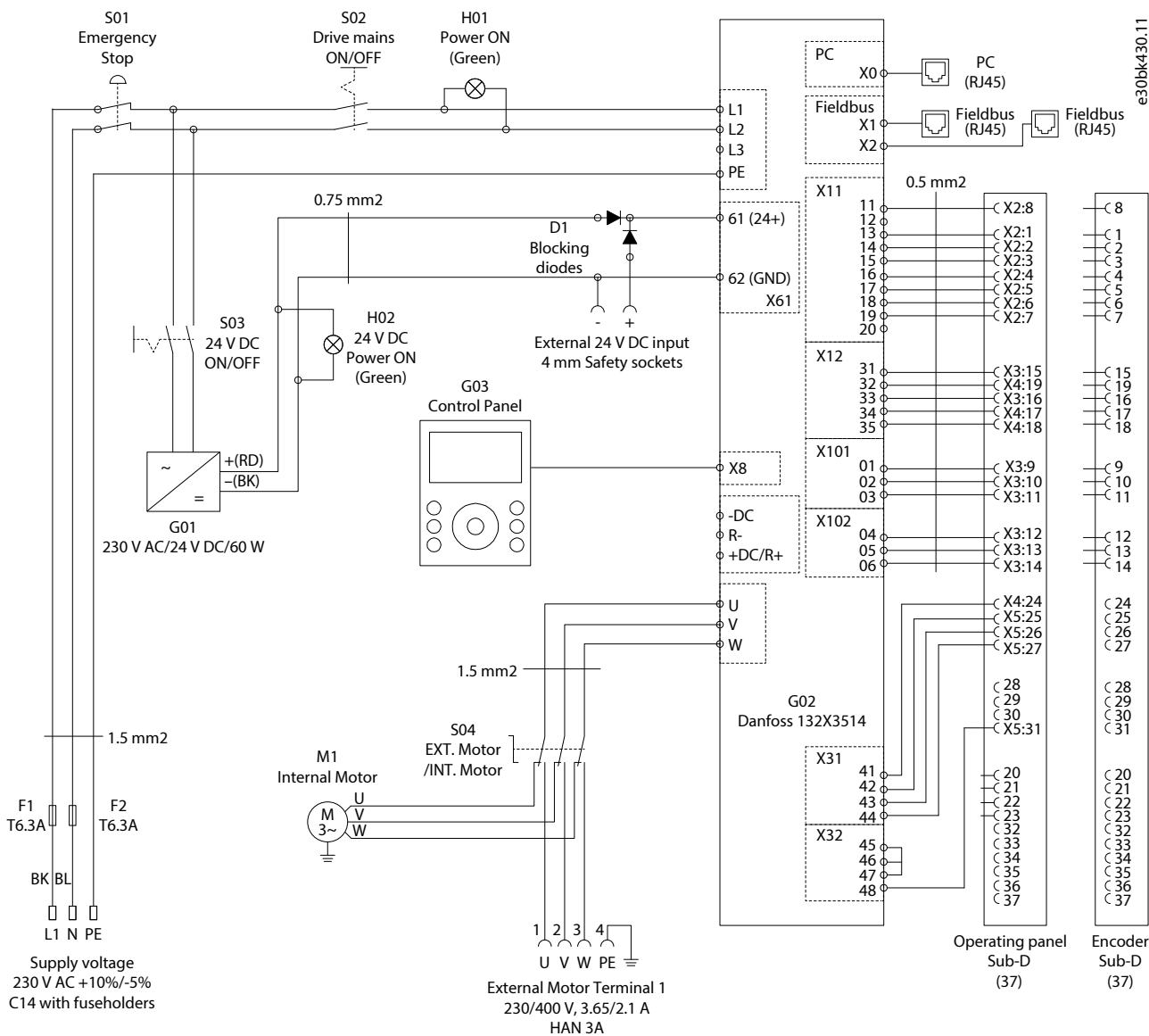

Figure 4: Wiring Diagram of TechCase iC7

### 7.2 Technical Data

The table includes specifications for the TechCase iC7. For technical data for the frequency converter, see the *iC7-Automation Frequency Converters Design Guide*.

Table 4: Specifications for the TechCase iC7

Item	Specification
Supply voltage ( $U_{IN}$ )	230 V AC +10%/-5%, 1-phase
Input current ( $I_{IN}$ )	3.5/3.1 A
Input frequency ( $f_{IN}$ )	50/60 Hz

Table 4: Specifications for the TechCase iC7 (continued)

Item	Specification
Protection class	Class I Required PE-connections to: <ul style="list-style-type: none"> <li>• Mounting plate</li> <li>• Rack</li> <li>• Drive</li> <li>• All accessible metal parts</li> </ul>
Protection rating	IP00
Weight	12.3 kg (27 lb)
Ambient temperature, storage	-40...+55 °C (-40...+131 °F), +70 °C (+158 °F) up to 4 months
Ambient temperature, transportation	-40...+70 °C (-40...+158 °F)
Ambient temperature, operation	-40...+70 °C (-40...+158 °F)
Climatic condition, storage	1K21, maximum 95% non-condensing
Climatic condition, transportation	2K11, maximum 95% non-condensing
Climatic condition, operation	3K22, maximum 95% non-condensing
Vibration, storage	1M11
Vibration, transportation	2M5
Vibration, operation	3M11



**Danfoss Drives Oy**  
Runsorintie 7  
FIN-65380 Vaasa  
[www.danfoss.com](http://www.danfoss.com)

.....  
Any information, including, but not limited to information on selection of product, its application or use, product design, weight, dimensions, capacity or any other technical data in product manuals, catalog descriptions, advertisements, etc. and whether made available in writing, orally, electronically, online or via download, shall be considered informative, and is only binding if and to the extent, explicit reference is made in a quotation or order confirmation. Danfoss cannot accept any responsibility for possible errors in catalogs, brochures, videos and other material. Danfoss reserves the right to alter its products without notice. This also applies to products ordered but not delivered provided that such alterations can be made without changes to form, fit or function of the product. All trademarks in this material are property of Danfoss A/S or Danfoss group companies. Danfoss and the Danfoss logo are trademarks of Danfoss A/S. All rights reserved.  
.....

