

DRAPER®

D20
MULTI-TOOL BATTERY SYSTEM

GB ORIGINAL LANGUAGE

20V BRUSHLESS 125mm/115mm
**ANGLE
GRINDER**

98104



These instructions accompanying the product are the original instructions. This document is part of the product, keep it for the life of the product passing it on to any subsequent holder of the product. Read all these instructions before assembling, operating or maintaining this product.

This manual has been compiled by Draper Tools describing the purpose for which the product has been designed, and contains all the necessary information to ensure its correct and safe use. By following all the general safety instructions contained in this manual, it will ensure both product and operator safety, together with longer life of the product itself.

All photographs and drawings in this manual are supplied by Draper Tools to help illustrate the operation of the product.

Whilst every effort has been made to ensure the accuracy of information contained in this manual, the Draper Tools policy of continuous improvement determines the right to make modifications without prior warning.

1. INTRODUCTION



1.1 SCOPE

This hand held power tool uses abrasive discs to grind/cut metals or masonry.

As part of our core range it is suitable for enthusiasts and tradespeople alike, any application other than that it was intended for, is considered misuse.

This product is not a toy and must not be used by children or any person with reduced physical, sensory or mental capabilities or lack of experience and knowledge, or people unfamiliar with these instructions.

Local regulations may restrict the age of the operator.

1.2 UNDERSTANDING THIS MANUALS SAFETY CONTENT:

 **Warning!** – Information that draws attention to the risk of injury or death.

Caution! – Information that draws attention to the risk of damage to the product or surroundings.

1.3 EXPLANATION OF SYMBOLS



Read the instruction manual.



Wear face mask and safety glasses.



Wear ear defenders.



Wear protective gloves.



Long hair must be tied back.



Do not abandon into the environment.



Keep out of the reach of children.



Warning!



Warning! Risk of crushing.



Direction of rotation.



Continuous A-Weighted Sound Pressure Level.



Class II construction (Double insulated).



WEEE – Waste Electrical & Electronic Equipment.

Do not dispose of Waste Electrical & Electronic Equipment in with domestic rubbish.



Lithium-ion product.



Do not incinerate or throw onto fire.



For indoor use only. Do not expose to rain.



Fuse protective device.



Polarity indication.



Rated voltage.



European conformity.



UK Conformity Assessed.

2. SPECIFICATION



2.1 SPECIFICATION

Stock No.	98104
Part No.	D20AG
Rated voltage	20V
Revolutions per minute (no load):	8,500r/min
Disc Diameter:.....	125mm/115mm
Spindle thread:	M14
Sound pressure level (LpA):	88dB(A)
Sound power level (LWA):.....	99dB(A)
Uncertainty (K):	3dB(A)
Vibration level Main handle:.....	AG=3.7m/s ² , K=1.5m/s ²
Weight (machine only):.....	1.46kg

3. HEALTH AND SAFETY INFORMATION



3.1 GENERAL SAFETY INSTRUCTIONS FOR POWER TOOL USE

 **Warning!** Read all safety warnings, instructions, illustrations and specifications provided with this power tool. Failure to follow all instructions listed below may result in electric shock, fire and/or serious injury.

Save all warnings and instructions for future reference.

The term “power tools” in the warnings refers to your mains-operated (corded) power tool or battery-operated (cordless) power tool.

1) Work area safety

- a) **Keep work area clean and well lit.** Cluttered or dark areas invite accidents.
- b) **Do not operate power tools in explosive atmospheres, such as in the presence of flammable liquids, gases or dust.** Power tools create sparks which may ignite the dust or fumes.
- c) **Keep children and bystanders away while operating a power tool.** Distractions can cause you to lose control.

2) Electrical safety

- a) **Power tool plugs must match the outlet. Never modify the plug in any way. Do not use any adapter plugs with earthed (grounded) power tools.** Unmodified plugs and matching outlets will reduce risk of electric shock.
- b) **Avoid body contact with earthed or grounded surfaces, such as pipes, radiators, ranges and refrigerators.** There is an increased risk of electric shock if your body is earthed or grounded.
- c) **Do not expose power tools to rain or wet conditions.** Water entering a power tool will increase the risk of electric shock.
- d) **Do not abuse the cord. Never use the cord for carrying, pulling or unplugging the power tool. Keep cord away from heat, oil, sharp edges or moving parts.** Damaged or entangled cords increase the risk of electric shock.
- e) **When operating a power tool outdoors, use an extension cord suitable for outdoor use.** Use of a cord suitable for outdoor use reduces the risk of electric shock.
- f) **If operating a power tool in a damp location is unavoidable, use a residual current device (RCD) protected supply.** Use of an RCD reduces the risk of electric shock.

3) Personal safety

- a) **Stay alert, watch what you are doing and use common sense when operating a power tool. Do not use a power tool while you are tired or under the influence of drugs, alcohol or medication.** A moment of inattention while operating power tools may result in serious personal injury.
- b) **Use personal protective equipment Always wear eye protection.** Protective equipment such as a dust mask, non-skid safety shoes, hard hat or hearing protection use for appropriate conditions will reduce personal injuries.
- c) **Prevent unintentional starting. Ensure the switch is in the off-position before connecting to power source and/or battery pack, picking up or carrying the tool.** Carrying power tools with your finger on the switch or energising power tools that have the switch on invites accidents.
- d) **Remove any adjusting key or wrench before turning the power tool on.** A wrench or a key left attached to a rotating part of the power tool may result in personal injury.
- e) **Do not overreach. Keep proper footing and balance at all times.** This enables better control of the power tool in unexpected situations.
- f) **Dress properly. Do not wear loose clothing or jewellery. Keep your hair and clothing away from moving parts.** Loose clothes, jewellery or long hair can be caught in moving parts.
- g) **If devices are provided for the connection of dust extraction and collection facilities, ensure these are connected and properly used.** Use of dust collection can reduce dust-related hazards.
- h) **Do not let familiarity gained from frequent use of tools allow you to become complacent and ignore tool safety principles.** A careless action can cause severe injury within a fraction of a second.

4) Power tool use and care

- a) **Do not force the power tool. Use the correct power tool for your application.** The correct power tool will do the job better and safer at the rate for which it was designed.
- b) **Do not use the power tool if the switch does not turn it on and off.** Any power tool that cannot be controlled with the switch is dangerous and must be repaired.
- c) **Disconnect the plug from the power source and/or remove the battery pack, if detachable, from the power tool before making any adjustments, changing**

accessories, or storing power tools. Such preventive safety measures reduce the risk of starting the power tool accidentally.

- d) **Store idle power tools out of the reach of children and do not allow persons unfamiliar with the power tool or these instructions to operate the power tool.** Power tools are dangerous in the hands of untrained users.
 - e) **Maintain power tools and accessories. Check for misalignment or binding of moving parts, breakage of parts and any other condition that may affect the power tool's operation. If damaged, have the power tool repaired before use.** Many accidents are caused by poorly maintained power tools.
 - f) **Keep cutting tools sharp and clean.** Properly maintained cutting tools with sharp cutting edges are less likely to bind and are easier to control.
 - g) **Use the power tool, accessories and tool bits etc. in accordance with these instructions, taking into account the working conditions and the work to be performed.** Use of the power tool for operations different from those intended could result in a hazardous situation.
 - h) **Keep handles and grasping surfaces dry, clean and free from oil and grease.** Slippery handles and grasping surfaces do not allow for safe handling and control of the tool in unexpected situations.
- 5) **Service**
- a) **Have your power tool serviced by a qualified repair person using only identical replacements parts.** This will ensure that the safety of the power tool is maintained.

3.2 ADDITIONAL SAFETY INSTRUCTIONS FOR GRINDERS

Warning!

Safety instructions for all operations

Safety warnings common for grinding:

- a) **This power tool is intended to function as a grinder. Read all safety warnings, instructions, illustrations and specifications provided with this power tool.** Failure to follow all instructions listed below may result in electric shock, fire and/or serious injury.
- b) **Operations such as polishing, sanding, wire brushing or cutting-off are not recommended to be performed with this power tool.** Operations for which the power tool was not designed may create a hazard and cause personal injury.

- c) **Do not use accessories which are not specifically designed and recommended by the tool manufacturer.** Just because the accessory can be attached to your power tool, it does not assure safe operation.
- d) **The rated speed of the grinding accessories must be at least equal to the maximum speed marked on the power tool.** Grinding accessories running faster than their rated speed can break and fly apart.
- e) **The outside diameter and the thickness of your accessory must be within the capacity rating of your power tool.** Incorrectly sized accessories cannot be adequately controlled.
- f) **Threaded mounting of accessories must match the grinder spindle thread. For accessories mounted by flanges, the arbour hole of the accessory must fit the locating diameter of the flange.** Accessories that do not match the mounting hardware of the power tool will run out of balance, vibrate excessively and may cause loss of control.
- g) **Do not use a damaged accessory. Before each use inspect the accessory such as abrasive wheels for chips and cracks, sanding drum for cracks, tear or excess wear, wire brush for loose or cracked wires. If power tool or accessory is dropped, inspect for damage or install an undamaged accessory. After inspecting and installing an accessory, position yourself and bystanders away from the plane of the rotating accessory and run the power tool at maximum no-load speed for one minute.** Damaged accessories will normally break apart during this test time.
- h) **Wear personal protective equipment. Depending on application, use face shield, safety goggles or safety glasses. As appropriate, wear dust mask, hearing protectors, gloves and workshop apron capable of stopping small abrasive or workpiece fragments.** The eye protection must be capable of stopping flying debris generated by various operations. The dust mask or respirator must be capable of filtering particles generated by your operation. Prolonged exposure to high intensity noise may cause hearing loss.
- j) **Hold the power tool by insulated gripping surfaces only, when performing an operation where the cutting accessory may contact hidden wiring or its own cord.** Cutting accessory contacting a "live" wire may make exposed metal parts of the power tool "live" and could give the operator an electric shock.

- k) **Keep bystanders a safe distance away from work area. Anyone entering the work area must wear personal protective equipment.** Fragments of workpiece or of a broken accessory may fly away and cause injury beyond immediate area of operation.
- l) **Position the cord clear of the spinning accessory.** If you lose control, the cord may be cut or snagged and your hand or arm may be pulled into the spinning accessory.
- m) **Never lay the power tool down until the accessory has come to a complete stop.** The spinning accessory may grab the surface and pull the power tool out of your control.
- n) **Do not run the power tool while carrying it at your side.** Accidental contact with the spinning accessory could snag your clothing, pulling the accessory into your body.
- o) **Regularly clean the power tool's air vents.** The motor's fan will draw the dust inside the housing and excessive accumulation of powdered metal may cause electrical hazards.
- p) **Do not operate the power tool near flammable materials.** Sparks could ignite these materials.
- q) **Do not use accessories that require liquid coolants.** Using water or other liquid coolants may result in electrocution or shock.

Further safety instructions for all operations

Kickback and related warnings

Kickback is a sudden reaction to a pinched or snagged rotating wheel, sanding band, brush or any other accessory. Pinching or snagging causes rapid stalling of the rotating accessory which in turn causes the uncontrolled power tool to be forced in the direction opposite of the accessory's rotation.

For example, if an abrasive wheel is snagged or pinched by the workpiece, the edge of the wheel that is entering into the pinch point can dig into the surface of the material causing the wheel to climb out or kick out. The wheel may either jump toward or away from the operator, depending on direction of the wheel's movement at the point of pinching. Abrasive wheels may also break under these conditions.

Kickback is the result of power tool misuse and/or incorrect operating procedures or conditions and can be avoided by taking proper precautions as given below.

- a) **Maintain a firm grip on the power tool and position your body and arm to allow you to resist kickback forces.** The operator can control kickback forces, if proper precautions are taken.
- b) **Use special care when working corners, sharp edges etc. Avoid bouncing and snagging the accessory.** Corners, sharp edges or bouncing have a tendency to snag

- the rotating accessory and cause loss of control or kickback.
- c) **Do not attach a toothed saw blade.** Such blades create frequent kickback and loss of control.
- d) **Always feed the bit into the material in the same direction as the cutting edge is exiting from the material (which is the same direction as the chips are thrown).** Feeding the tool in the wrong direction causes the cutting edge of the bit to climb out of the work and pull the tool in the direction of this feed.
- e) **When using rotary files, cut-off wheels, high-speed cutters or tungsten carbide cutters, always have the work securely clamped.** These wheels will grab if they become slightly canted in the groove, and can kickback. When a cut-off wheel grabs, the wheel itself usually breaks. When a rotary file, high-speed cutter or tungsten carbide cutter grabs, it may jump from the groove and you could lose control of the tool.

Safety Warnings Specific for Grinding and Abrasive Cutting-Off Operations:

- a) **Use only wheel types that are recommended for your power tool and the specific guard designed for the selected when.** Wheels for which the power tool was not designed cannot be adequately guarded and are unsafe
- b) **The grinding surface of centre depressed wheels must be mounted below the plane of the lip guard.** An improperly mounted when that projects through the plane of the guard lip cannot be adequately protected.
- c) **The guard must be securely attached to the power tool and positioned for maximum safety, so the least amount of wheel is exposed towards the operator.** The guard helps to protect the operator from broken wheel fragments, accidental contact with wheel and sparks that could ignite clothing.
- d) **Wheels must be used only for recommended applications. For example: do not grind with the side of the cut-off wheel.** Abrasive cut-off wheels are intended for peripheral grinding, side forces applied to these wheels may cause them to shatter.
- e) **Always use undamaged wheel flanges that are of correct size and shape for your selected wheel.** Proper wheel flanges support the wheel thus reducing the possibility of wheel breakage. Flanges for cut-off wheels may be different from grinding wheel flanges.
- f) **Do not use worn down wheels from larger**

power tools. Wheels intended for larger power tool is not suitable for the higher speed of a smaller tool and may burst.

with the guard. Wire wheel or brush may expand in diameter due to work load and centrifugal forces.

Additional Safety Warnings Specific for Abrasive Cutting-Off Operations:

- a) **Do not “jam” the cut-off wheel or apply excessive pressure. Do not attempt to make and excessive depth of cut.**
Overstressing the wheel increases the loading and susceptibility to twisting or binding of the wheel in the cut and possibility of kickback or wheel breakage.
- b) **Do not position you body in line with and behind the rotating wheel.** When the wheel, at the point of operation, is moving away from your body, the possible kickback may propel the spinning wheel and the power tool directly at you.
- c) **When wheel is binding or when interrupting a cut for any reason, switch off the power tool and hold the power tool motionless until the wheel comes to a complete stop. Never attempt to remove the cut-off wheel from the cut while the wheel is in motion otherwise kickback may occur.** Investigate and take corrective action to eliminate the cause of wheel binding.
- d) **Do not restart the cutting operation in the workpiece. Let the wheel reach full speed and carefully re-enter the cut.** The wheel may bind, walk up or kickback if the power tool is restarted in the workpiece.
- e) **Support panels or any oversized workpiece to minimize the risk of wheel pinching and kickback.** Large workpieces tend to sag under their own weight. Supports must be placed under the workpiece near the line of cut and near the edge of the workpiece on both sides of the wheel.
- f) **Use extra caution when making a “pocket cut” into existing walls or other blind areas.** The protruding wheel may cut gas or water pipes, electrical wiring or objects that can cause kickback.

Additional safety instructions for wire brushing operations

Safety Warnings Specific for Wire Brushing Operations:

- a) **Be aware that wire bristles are thrown by the brush even during ordinary operation. Do not overstress the wires by applying excessive load to the brush.** The wire bristles can easily penetrate light clothing and/or skin.
- b) **If the use of a guard is recommended for wire brushing, do not allow any interference of the wire wheel or brush**

3.3 SAFETY INSTRUCTIONS FOR MAINS POWERED CHARGERS & BATTERY PACKS

Chargers

- The charger is for indoor use only.
- Prior to plugging the charger in to the supply, check that the plug, cable and charger casing are in good condition. If any are damaged, have the defective part(s) replaced immediately by a suitably qualified person.
- Only use a correctly rated mains outlet to provide power, do not plug into site generators, attach to engine generators or D.C. sources. Do not use a mains socket outlet that is not switched.
- Use the correct Draper charger in conjunction with it's corresponding battery pack (consult the Draper website for more information or to find your local stockist).
- Do not charge any other batteries with Draper chargers. Any other application is considered misuse.
- Do not attempt to charge battery packs that are too hot (over 30°C) or too cold (under 5°C), if these conditions apply set the battery pack aside to “normalise” before proceeding with the charging operation.
- Set up the charger and cable in a safe place where it won't be knocked, tripped over, stepped on, etc. and where it is well ventilated. Make sure the ventilation slots in the charger case are not obstructed.
- Inspect the battery pack for damage, if it is undamaged, plug it into the charger, ensuring the correct orientation.
- Switch the charger on and check that the correct indicators illuminate, allow the battery pack to charge (see the specific instructions for your charger). Once charging is complete, switch the charger off, disconnect from power supply, remove the battery pack and store.

Battery packs

- Before charging, read the instructions.
- Do not expose to rain.
- Only use Draper D20 battery packs with this product. Consult your Draper stockist for details.
- Do not charge any other batteries with Draper chargers. Any other application is considered misuse.
- The charger must be disconnected from the power supply before removing the battery.
- The battery must be removed from the appliance before it is recycled.



- The battery is to be disposed of in-line with local authority procedures.
- Do not crush, open or burn the battery. Exposure to potentially harmful materials may occur.
- In case of fire use CO₂ or dry chemical extinguisher.
- Do not expose to high temperatures >50°C. The battery may degrade at high temperatures.
- Charge battery in conditions between 5°C to 30°C with the designated charger for the battery.
- Do not use battery if it has been stored at 5°C or less. Allow it to “normalise” at room temperature before usage/charging.

⚠ Warning! – Leaking battery packs

- The electrolyte in battery packs is corrosive. Avoid contact with the skin.
- If contact is made, flush the area with clean water, pat dry and seek medical attention at the earliest opportunity.
- Inform medical personnel that the contaminant is a “high alkaline, corrosive liquid”.
- If electrolyte comes into contact with the eyes, flush with copious amounts of water only. Seek immediate medical attention, relaying the information above.

3.4 CONNECTION TO THE POWER SUPPLY (CHARGER)

Caution: Risk of electric shock. Do not open.

This appliance is supplied with an approved plug and cable for your safety. The value of the fuse fitted is marked on the pin face of the plug. Should the fuse need replacing, ensure the substitute is of the correct rating, approved to BS1362 and ASTA  or BSI Kite  marked.

Ensure the fuse cover is replaced before attempting to connect the plug to an electrical outlet. If the cover is missing, a replacement must be obtained or the plug replaced with a suitable type.

If a replacement plug is to be fitted this must be carried out by a qualified electrician.

Never use a damaged or incomplete plug.

This appliance is Class II[†] and is designed for connection to a power supply matching that detailed on the rating label and compatible with the plug fitted.

Carefully select an extension lead. Some machines are not suitable for use with extension leads. If the tool is designed for use outdoors, only use an extension lead suitable for that environment in conjunction with an RCD adaptor. When using an extension lead, select one capable of handling the current (amps) drawn by the machine in use. Ensure the cable is fully unwound regardless of the distance between the power supply and the tool. Excess current (amps) and a coiled extension lead will cause the cable to heat up and can result in fire.

Keep extension leads away from moving hazardous parts to avoid damages to the cable which can lead to contact with live parts. Position cable safely to avoid tripping over.

[†]Double insulated : This product requires no earth connection as supplementary insulation is applied to the basic insulation to protect against electric shock in the event of failure of the basic insulation.

Important! If using an extension lead, follow the instructions that came with your lead regarding maximum load while cable is wound. If in doubt, ensure that the entire cable is unwound. Using a coiled extension lead will generate heat which could melt the lead and cause a fire.

4. UNPACKING AND CHECKING



4.1 PACKAGING

Carefully remove the product from the packaging and examine it for any sign of damage. Check contents against the parts shown in Fig A. If any part is damaged or missing, please contact the Draper Help Line (see back page). Do not attempt to use the product!

The packaging material should be retained during the warranty period, in case the product needs to be returned for repair.

⚠ Warning!

- Some of the packaging materials may be harmful to children. Do not leave any of these materials in reach of children.
- If any of the packaging is to be thrown away, make sure they are disposed of correctly, according to local regulations.

5. IDENTIFICATION – FIG.A

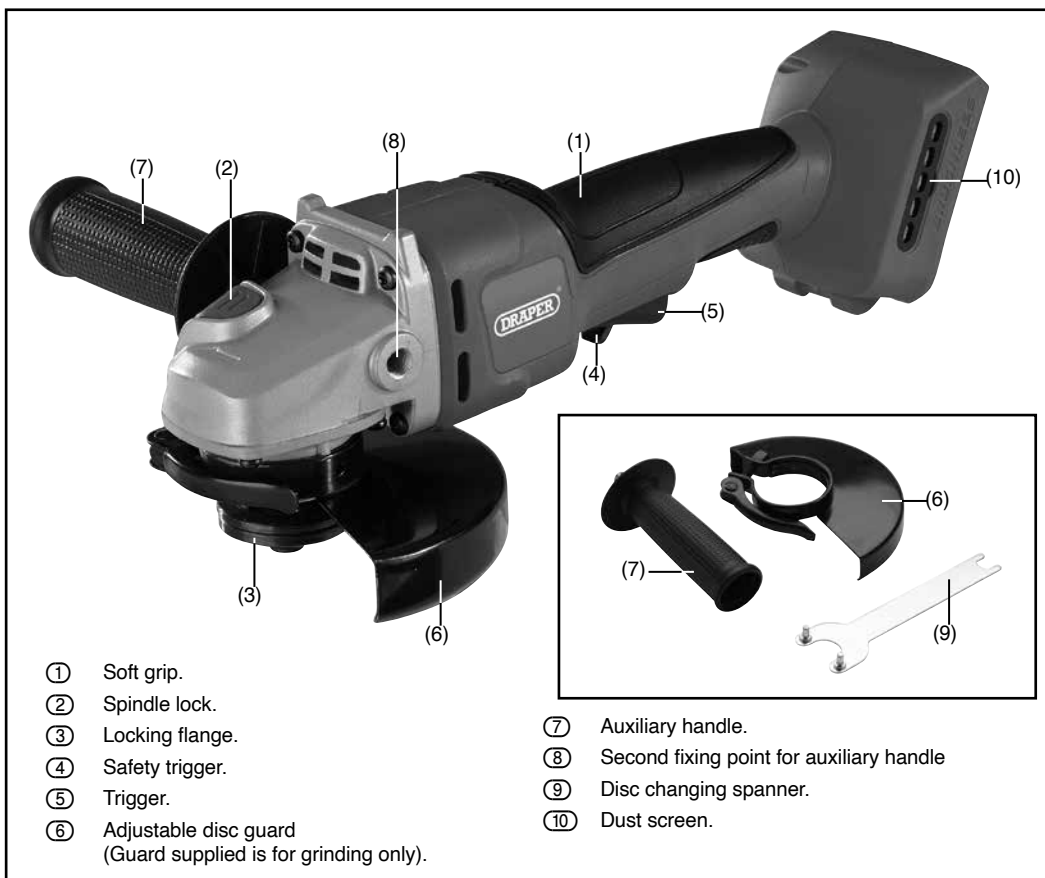

FIG.A

6. BASIC OPERATIONS

Note: For details of our full range of accessories, please visit drapertools.com

6.1 ON/OFF SWITCH – FIG. 1

⚠ Warning! We strongly recommend that personal protection equipment is worn.

⚠ Warning! Excessive start/stopping of this angle grinder will result in the machine not functioning. In this situation leave the grinder for a few minutes; it will then reset and operate normally.

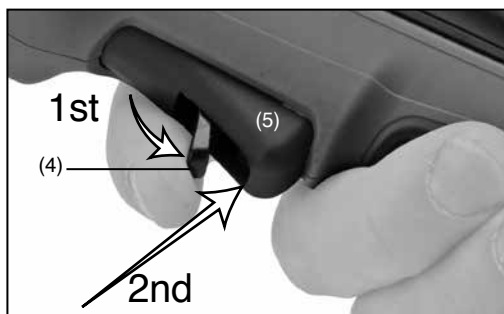

FIG. 1

6.2 GRINDING

When performing grinding operations maintain an angle of approximately 30° between the work surface and the disc face.

Only use abrasives specifically designed for this task.

Warning!

Important legal information:

- Cutting operations should only be attempted with the “cutting” guard fitted to this grinder.
- Please contact Draper Tools for further information on how to purchase this optional accessory.
- This guard must be fitted for your safety.
- When performing cutting-off operations do not incline the machine as this can lead to the abrasive wheel becoming jammed, damaged or excessively and abnormally worn.
- Only use abrasives specifically designed for this task.

Warning: As the abrasive wheel wears during use, its diameter reduces. This reduces the peripheral speed and the machine’s efficiency. This results in increased load on the grinding machine which if continued will damage the motor. Ensure that the diameter of the wheel is within 25% of its original size.

Important: Excessive pressure on the machine does not result in a higher abrasive efficiency. Excessive pressure increases wear and tear on the accessory and will damage the angle grinder which is not covered under the warranty.

6.3 FITTING THE GUARD - FIGS. 2–4

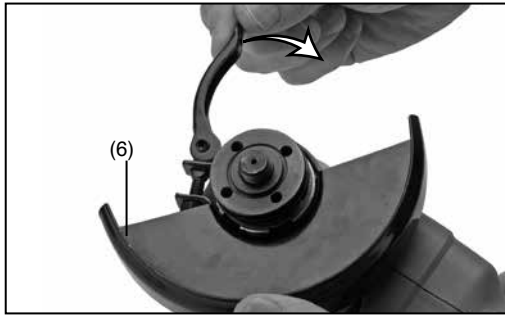

FIG. 2



FIG. 3



FIG. 4

To fit:

Position the guard (6) onto the grinder collar with the quick release lever open. Rotate the guard until the spigot lines up with the cutout, once located the guard can be rotated to the working position and tightened.

To remove:

Open quick release lever, rotate the guard until the spigot lines up with the cutout, and remove.

 Warning! Never attempt to operate this machine without the guard securely fitted and correctly positioned*.

* With the exception of wire cup brushes etc. which negate the guards effectiveness.

6.4 FITTING/REPLACING ACCESSORIES (sold separately) – FIG. 5

Warning! Prior to mounting an abrasive wheel ensure the expiry date has not expired, rendering it potentially hazardous.

Warning! Selection of the correct accessory, suitable for the intended application is vital. Seek guidance if uncertain of selection.

Warning! The rated (no load) revolutions per minute of the tool must not exceed the speed capacity of the accessory. Please refer to the accessory manufacturers instructions for information.

Visual Inspection:

- Prior to fitting, abrasive/superabrasive wheels shall be subject to a visual inspection.

Inspection:

- Each time after mounting, the abrasive/superabrasive wheel shall be test run for a reasonable time.
- The specified maximum operating speed of the wheel shall not be exceeded.
- Damaged abrasives shall be destroyed.
- Always wear approved safety goggles.



Important information:

B, C, D :

For cutting applications, and to comply to current legislation, it is necessary to replace the “grinding” guard supplied with this machine with a “cutting” guard (Please consult the Draper website or your local stockist for details). High oscillation frequency:

Grinder Spindle (M14)

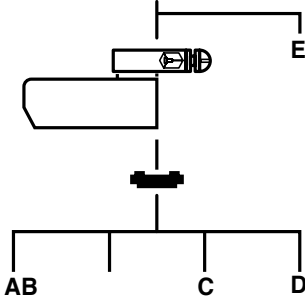

**A. Type 27:
Depressed Centre Grinding Wheel**

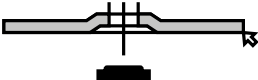

**B. Type 41:
Flat Cutting-off Wheel**



**C. Type 42:
Depressed Centre Cutting-off Wheel**



**D. Superabrasive Wheel
(Diamond/CBN Abrasive)**

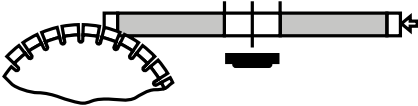

E. Wire Cup Brush

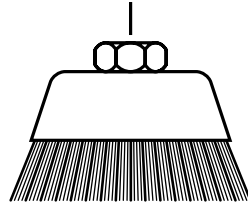

FIG. 5

6.5 FITTING GRINDING DISCS - FIGS. 6-7

Press and hold the spindle lock button (2). Loosen the locking flange (3) anti-clockwise using the pin spanner (9) supplied. The spindle may rotate slightly before the spindle lock fully engages.

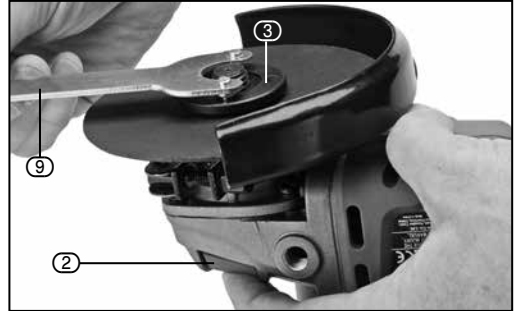

FIG. 6



FIG. 7

Remove the locking flange only. Clean the flanges and spindle prior to fitting any accessory. If the rear flange is removed for cleaning, ensure it locates correctly on the spindle flats when refitting and does not spin freely.

When fitting the appropriate accessory please refer to (Fig.5) for specific details on the locking flange correct orientation as applicable.

Securely tighten the locking flange clockwise using the disc changing spanner (8) while holding down the spindle lock (2).

Note: When using wire cup brushes the locking flange is not required due to the design of the brushes. When fitted check the accessory is correct and, importantly fully secure on the spindle.

Warning: Never press the spindle lock button (2) while the spindle is in motion.

6.6 BATTERY PACK CHARGING – FIGS. 8–9

This power product is supplied “bare”, without battery pack or charger. For compatible batteries, chargers and accessories please visit www.drapertools.com.

Important! Draper designated battery packs and chargers must only be used with this product. Use of any other third-party battery packs/chargers is considered misuse and will invalidate the warranty.

Once connected to the mains supply, recharging of the battery can be left generally unsupervised.

Warning! Check the condition of the charger and battery prior to each charge. Do not use if there is any sign of damage.

The battery pack is supplied un-charged and must be charged before initial use.

To charge the battery pack (12):

- Plug the battery charger (11) unit into a suitable mains power supply socket.
- The red LED (11.1) will illuminate to show the charger has power.
- Slide the battery into the charger’s aligning pins.
- After a few seconds delay, the red LED will flash to show that charging has begun, then changes to solid red.
- Whilst the battery is charging, the green LED (11.2) will flash, (the red LED will go from flashing to constant red).
- When the battery is fully charged when the green LED stops flashing and changes to solid green. The red LED will turn off.



FIG. 8

To release the battery pack:

- Press the battery release button (12.1) and gently slide the battery pack off.

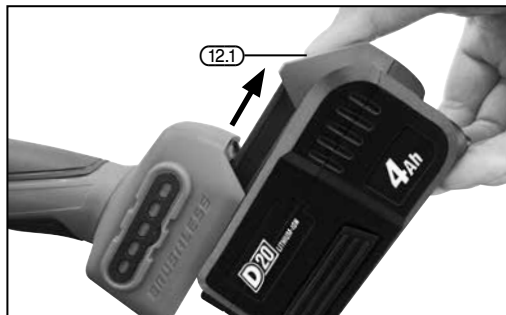

FIG. 9

6.7 BATTERY PACK PROTECTION FEATURES

Overcharging protection: When the battery pack is fully charged, the transformer/charger will automatically shut off, protecting the internal components.

Over-discharging protection: Stops the battery pack from discharging beyond the recommended lowest safety voltage.

Overheating protection: An internal thermistor cut-off sensor shuts off the battery pack should it become too hot during operation. For example, if the tool is overloaded or used for extended periods. 30 minutes cooling time may be required.

Current protection: If the battery is overloaded or the maximum current draw exceeded, the battery will shut off to protect internal components. The battery pack will resume operation once the current draw is at a safe level.

Short circuit protection: The battery pack will stop operating immediately if it was to short circuit.

6.8 BATTERY PACK CHARGE STATUS – FIG.10

Press the charge level indicator button (12.2) to display the battery charge level.

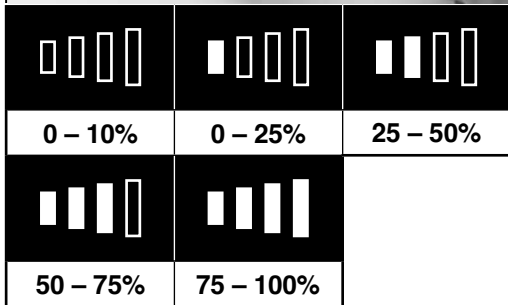
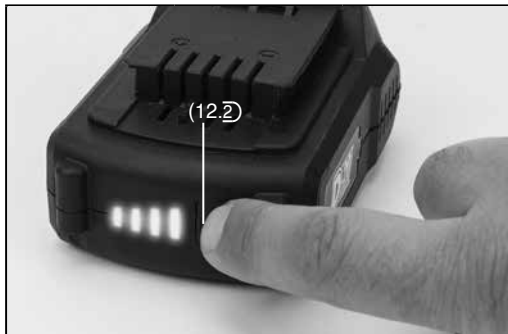

FIG. 10

6.9 BATTERY LIFE EFFICIENCY AND CHARGING ADVICE

- A rechargeable battery will be hot immediately after use. If such a battery is recharged immediately after use the battery life will be shortened. Leave the battery and recharge it after it has cooled.
- The battery needs to be warmed-up or cooled down to prevent damaging to the batteries internal components.

7. MAINTENANCE AND TROUBLESHOOTING

7.1 TROUBLESHOOTING GUIDE

Problems	Possible cause	Required action
Tool does not operate.	<ul style="list-style-type: none"> – Battery pack no charge. – Battery pack faulty or damaged. 	<ul style="list-style-type: none"> – Re-charge battery pack. – Replace battery pack.
Motor runs, but slowly/ losing power.	<ul style="list-style-type: none"> – Battery pack no charge. – Battery pack faulty or damaged. 	<ul style="list-style-type: none"> – Re-charge battery pack. – Replace battery pack.
Machine vibrates.	<ul style="list-style-type: none"> – Wheel damaged or out of balance. – Wheel loose. 	<ul style="list-style-type: none"> – Replace wheel. – Stop machine immediately – when stopped, refit accessory.
Wheel will not cut/grind.	<ul style="list-style-type: none"> – Incorrect disc fitted. 	<ul style="list-style-type: none"> – Fit correct disc for material/ application.
Battery pack doesn't charge / non illumination of charger.	<ul style="list-style-type: none"> – Fuse blown in charger plug. – Charger faulty. 	<ul style="list-style-type: none"> – Replace fuse. – Replace charger.

7.2 MAINTENANCE

Regular inspection and cleaning reduces the necessity for maintenance operations and will keep your tool in good working condition.

Do not use solvents or fuels to clean the product. When not in use, store the product in a safe, dry place.

8. WARRANTY

8.1 WARRANTY

Draper tools have been carefully tested and inspected before shipment and are guaranteed to be free from defective materials and workmanship.

Should the tool develop a fault, please return the complete tool to your nearest distributor or contact:

Draper Tools Limited

UK: Chandler's Ford, Eastleigh, Hampshire,
SO53 1YF. England.

EU: Oude Graaf 8, 6002 NL Weert (NL).

Telephone Sales Desk: +44 (0)23 8049 4333 or:

Product Helpline +44 (0)23 8049 4344.

A proof of purchase must be provided.

If upon inspection it is found that the fault occurring is due to defective materials or workmanship, repairs will be carried out free of charge. This warranty period covering parts/labour is 24 months from the date of purchase except where tools are hired out when the warranty period is 90 days from the date of purchase. This warranty does not apply to any consumable parts, any type of battery or normal wear and tear, nor does it cover any damage caused by misuse, careless or unsafe handling, alterations, accidents, or repairs attempted or made by any personnel other than the authorised Draper warranty repair agent.

Note: If the tool is found not to be within the terms of warranty, repairs and carriage charges will be quoted and made accordingly.

This warranty applies in lieu of any other warranty expressed or implied and variations of its terms are not authorised.

Your Draper warranty is not effective unless you can produce upon request a dated receipt or invoice to verify your proof of purchase within the warranty period.

Please note that this warranty is an additional benefit and does not affect your statutory rights.

Draper Tools Limited.

9. DISPOSAL

9.1 DISPOSAL

Ensure that the machine is disposed of according to national regulations at the end of its working life or when it can no longer be repaired.

DO NOT:

- Dispose of power tools with domestic waste.
- Incinerate.
- Abandon in the environment.
- Dispose of WEEE as unsorted municipal waste.



Li-ion

9.2 BATTERY PACK DISPOSAL INFORMATION

Warning!

- Do not put battery packs in a fire or mutilate – cells may burst or release toxic materials.
- Do not short circuit cells, may cause burns.
- The battery pack must be removed from the appliance before it is scrapped.
- The battery pack is to be disposed of safely.
- Do not mutilate batteries, corrosive electrolyte will be released.
- Do not dispose of batteries or cells in a charged condition.

Expired batteries must be recycled/disposed of in accordance with the appropriate regulation or legislation. They should be returned to your local warranty agent/stockist.