

**EN**

Original Instructions  
Version 1

**DRAPER**<sup>®</sup>

2.8KW/2.4KW

# **INFRARED CABINET HEATER**

04745, 04746



**UK  
CA** **CE**

# 1. Preface

These are the original product instructions. This document is part of the product; retain it for the life of the product, passing it on to subsequent holders. Read this manual in full before attempting to assemble, operate, or maintain this product.

This Draper Tools manual describes the purpose of the product and contains all the necessary information to ensure its correct and safe use. Following all the instructions and guidance in this manual will ensure the safety of both the product and the operator and increase the lifespan of the product.

All photographs and drawings within this manual are supplied by Draper Tools to help illustrate correct operation of the product.

Every effort has been made to ensure the information contained in this manual is accurate. However, Draper Tools reserves the right to amend this document without prior warning. Always use the latest version of the product manual.

## 1.1 Product Reference

**User Manual for:** 2.8kW/2.4kW Infrared Cabinet Heater

**Stock No:** 04745, 04746

**Part No:** IRH2800, IRH2400

## 1.2 Revisions

**Version 1:** June 2022

First release

As our manuals are continually updated, always ensure that the latest version is used.

**Download the latest version from:**  
[drapertools.com/manuals](http://drapertools.com/manuals)

## 1.3 Understanding the Safety Content



**WARNING!** – Situations or actions that may result in personal injury or death.



**CAUTION!** – Situations or actions that may result in damage to the product or surroundings.

**Important:** – Information or instructions of particular importance.

## 1.4 Copyright © Notice

Copyright © Draper Tools Limited.

Permission is granted to reproduce this manual for personal and educational use **ONLY**. Commercial copying, redistribution, hiring, or lending is strictly prohibited.

No part of this manual may be stored in a retrieval system or transmitted in any other form or means without written permission from Draper Tools Limited.

In all cases, this copyright notice must remain intact.

1. Preface	2
1.1 Product Reference	2
1.2 Revisions	2
1.3 Understanding the Safety Content	2
1.4 Copyright © Notice	2
2. Contents	3
3. Warranty	4
4. Product Introduction	5
4.1 Scope	5
4.2 Specification	5
5. Health and Safety Information	6
5.1 General Health and Safety Precautions for This Heater	6
5.2 Connection to the Power Supply	7
6. Identification and Unpacking	8
6.1 Product Overview	8
6.2 What's in the Box?	9
6.3 Packaging	9
7. Preparing the Heater	10
7.1 Assembly	10
7.2 Positioning the Heater	10
8. Operating Instructions	11
8.1 Switching on the Heater Power	11
8.2 Standby Mode and the Default Display	11
8.3 Enabling the Lower Heating Element	12
8.4 Setting the Target Temperature	12
8.5 Setting and Initiating the Shutdown Timer	12
8.6 Using the Remote Control	13
8.7 Automatic Power Cut-Outs	14
9. Maintenance and Troubleshooting	15
9.1 General Maintenance and Storage	15
9.2 Removing and Replacing the Fireguard	15
9.3 Cleaning the Reflectors	15
9.4 Replacing the Heating Elements	16
9.5 Troubleshooting	17
10. Returns and Disposal	18
11. Explanation of Symbols	19

### 3. Warranty

---

Draper Tools products are carefully tested and inspected before shipment and are guaranteed to be free from defective materials and workmanship.

Should the tool develop a fault, return the complete tool to your nearest distributor or contact Draper Tools directly. Contact information can be found at the back of this manual.

Proof of purchase must be provided.

If, upon inspection, it is found that the fault occurring is due to defective materials or workmanship, repairs will be carried out free of charge. This warranty period covers parts and labour for 12 months from the date of purchase. Where tools have been hired out, the warranty period covers 90 days from the date of purchase.

This warranty does not apply to any consumable parts, batteries or normal wear and tear, nor does it cover any damage caused by misuse, careless or unsafe handling, alterations, accidents, or repairs attempted or made by any personnel other than the authorised Draper Tools repair agent.

In all cases, to make a claim for faulty workmanship or materials within the standard warranty period, please contact or return the product to the place of purchase. Proof of purchase may be required.

If the place of purchase is no longer trading or if you experience any difficulties with your warranty, please contact Customer Services with the product details and your proof of purchase. Contact details can be found at the back of this manual.

If the tool is not covered by the terms of this warranty, repairs and carriage charges will be quoted and charged accordingly.

This warranty supersedes any other guarantees expressed or implied and variations of its terms are not authorised.

Your Draper Tools guarantee is not effective until you can produce, upon request, a dated receipt or invoice to verify your purchase within the guarantee period.

Please note that this warranty is an additional benefit and does not affect your statutory rights.

#### **Draper Tools Limited**

## 4.1 Scope

This heater is intended to raise the ambient temperature in indoor environments and is suitable for domestic and light commercial use only. Any other application beyond the conditions established for use will be considered misuse. Draper Tools accepts no responsibility for improper use of this product.

Part of our core range, this product is suitable for enthusiasts and tradespersons alike.

 **WARNING! This product is not a toy and must be respected.**

Read this manual in full before attempting to assemble, operate or maintain the product, and retain it for later use.

## 4.2 Specification

Stock No.:	04745	04746
Part No.:	IRH2800	IRH2400
Rated voltage:	230V	110V
Rated input:	2,800W	2,400W
Rated frequency:	50Hz	50Hz
Fuse:	13A	N/A
Heating modes:		
Single:	1,400W	1,200W
Dual:	2,800W	2,400W
Dimensions:	W 558 x H 870 x D 491mm	W 558 x H 870 x D 491mm
Max. heat output:	9,553 BTU	8,188 BTU
IP rating:	IP20	IP20
Net weight:	15.8kg	16.3kg

## 5. Health and Safety Information

---

**Important:** Read all Health and Safety instructions before attempting to operate, maintain or repair this product. Non-compliance with these instructions may result in injury or damage to the user or the product.

### 5.1 General Health and Safety Precautions for This Heater

- Observe all standard safety precautions and good practices when working with electrical equipment.
- Take extra care when using this product around children.
  - Children of less than three years should be kept away unless continuously supervised.
  - Children aged between three years and eight years shall only switch on/off the appliance if it has been placed or installed in its intended normal operating position and they have been given supervision or instruction concerning use of the appliance in a safe way and understand the hazards involved.
  - Children aged between three years and eight years shall not plug in, regulate and clean the appliance or perform user maintenance.
- Keep your work environment clear and well-lit, with bystanders at a safe distance.
- Before every use, inspect the heater for broken, cracked, loose or corroded parts.
- Important: **DO NOT** use this product if it is damaged in any way. Contact Draper Tools to discuss repair and replacement options.
- Use the product only in the manner instructed in this manual and **DO NOT** modify it in any way.
- This heater is for indoor use **ONLY**.
- **DO NOT** expose this product to temperatures greater than 50°C.
- **DO NOT** use this heater in small rooms that are occupied by individuals that are not capable of leaving the room on their own, unless constant supervision is provided.
- **DO NOT** use the heater in dusty environments.
- The heater must **ONLY** be used in its upright position.
- **DO NOT** position the heater in close proximity to curtains or other combustible materials that may move and come into contact with the heater.
  - Allow a minimum of 2m clearance between the fireguard and any nearby objects.
- **DO NOT** position this heater in the vicinity of combustible materials, in explosive environments or in the presence of flammable or combustible gases and vapours.
- **DO NOT** position this heater below or pointing towards a power socket or outlet.
- Lock the wheels when the heater is stationary.
- **DO NOT** use the heater if the wheels have been removed as this may restrict airflow into the base of the unit.
- Ensure that the power switch is in the "OFF" (○) position before connecting the heater to the power supply.
- **ONLY** use this product with power supplies that match the rated voltage of the heater.
  - **NEVER** use this heater with an extension lead, multi-socket or plug adaptor; it must be plugged directly into the power supply.
  - **NEVER** plug more than one heater into the same power outlet.
- **NEVER** abuse the power cord.
  - Untangle the power cord fully before connecting it to the power supply.
  - **NEVER** remove the plug from the power supply by pulling on the cord.
  - **DO NOT** pull the product using the cable or plug.
  - Keep the power cord away from sources of heat, liquids, sharp edges and moving parts.
  - The power cord attached to this product is not suitable for use on building sites.
- **NEVER** allow the power cord to come into contact with other heated objects or direct the heater at the power cord or supply.
- This is a Class I appliance.
  - This product requires an earth connection to protect against electric shock from accessible conductive parts in the event of a failure of the basic insulation.
  - To reduce the risk of electric shock, avoid contact with earthed objects during use.
- **ALWAYS** check that the heater is positioned safely before turning it on.
- **NEVER** leave the heater unattended while it is on.
- Avoid body contact with earthed or grounded surfaces, such as pipes, radiators, ranges and refrigerators.
- **DO NOT** use this heater with a programmer, timer, separate remote-control system or any other device that switches the heater on automatically, as it may be covered or positioned incorrectly when activated and pose a fire risk.
- **NEVER** cover any part of the heater as this may cause the heater to overheat or the covering item to ignite or burn.

- **NEVER** insert foreign objects through the fireguard or other openings in the heater body.
- The fireguard of this heater is intended to prevent direct access to the heating elements and must be in place during use.
  - **DO NOT** use the heater if the fireguard is not correctly in place; reattach the guard securely before switching the heater on.
  - Be aware that the fireguard does not provide full protection against harm to children and infirm persons.

 **WARNING!**

- **DO NOT** allow the heater to come into contact with water or any other liquid.
- **DO NOT** use this heater in the vicinity of a bath, shower, swimming pool or other body of water.
- **DO NOT** touch the heater with wet hands.

 **WARNING!** Some parts of the product become very hot during use and may cause burns.

- **DO NOT** touch any metal part of the heater other than the handle or wheels during or immediately after use.
- **ALWAYS** switch off the heater, disconnect it from the power supply and allow it to cool for at least 20 minutes before attempting to move or reposition it.
- Particular attention **MUST** be given when children and vulnerable people are present.

## 5.2 Connection to the Power Supply

This appliance is supplied with an approved plug and cable for your safety.

If the power supply cord is damaged, it must be replaced by Draper Tools, an authorised service agent or similarly qualified personnel in order to avoid a hazard.

The damaged or incomplete plug, when cut from the cable, shall be disabled to prevent connection to a live electrical outlet.

This product is Class I<sup>†</sup> and is designed for connection to a power supply matching that detailed on the rating label and compatible with the plug fitted.

 **CAUTION! DO NOT** use this product with an extension lead or multi-socket.

Where a BS-approved three-pin plug is installed (Stock No. 04745), the value of the fuse fitted is marked on the pin face of the plug. Should the fuse need replacing, ensure the substitute is of the correct rating, approved to BS 1363/A and ASTA or BS Kite marked.

ASTA 

BSI 

The fuse can be replaced by removing the cover of the plug using a cross-headed screwdriver and removing the broken fuse from its holder. This should only be performed by suitably qualified personnel.

**†Earthed:** This product requires an earth connection to protect against electric shock from accessible conductive parts in the event of a failure of the basic insulation.

# 6. Identification and Unpacking

## 6.1 Product Overview

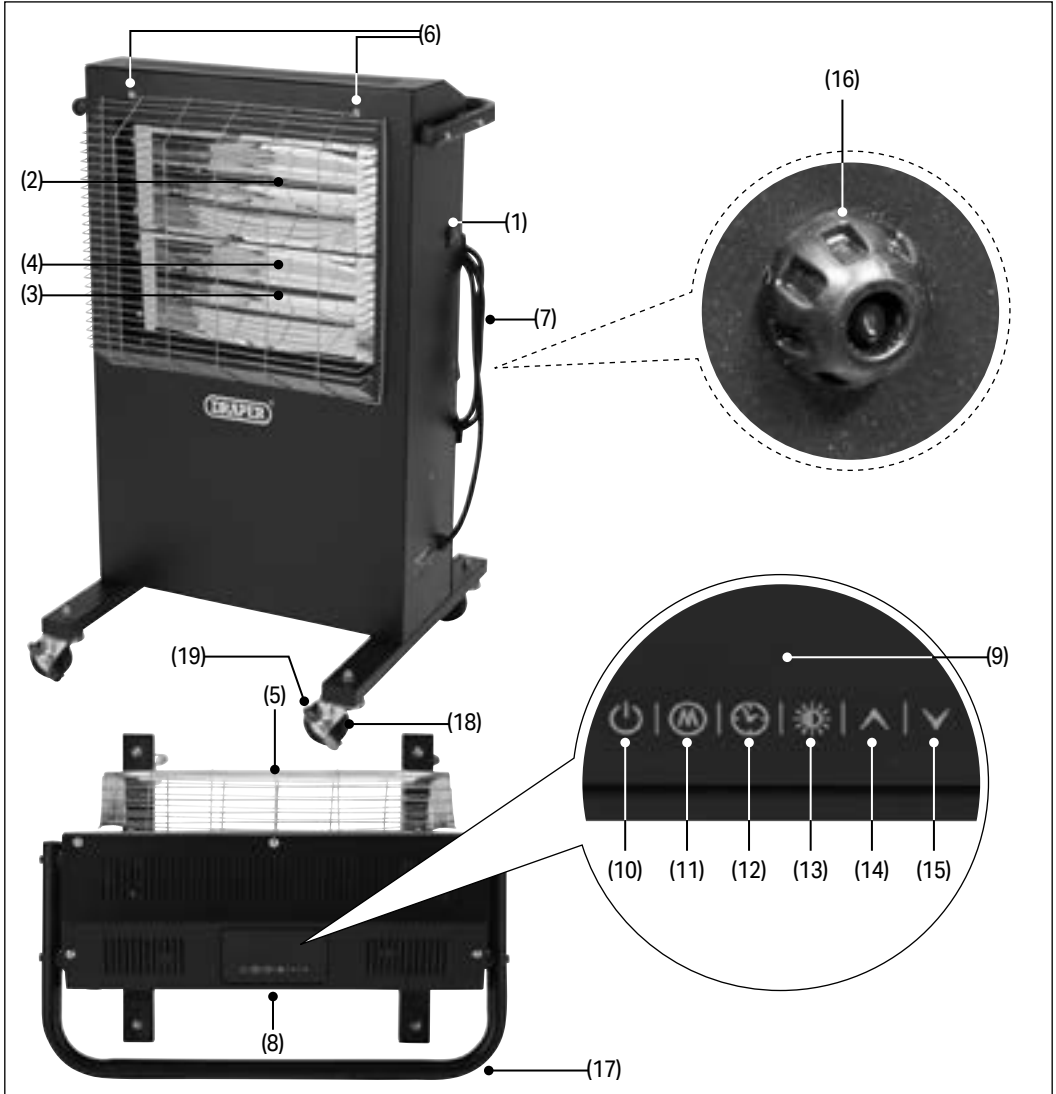

- (1) Power switch
- (2) Upper heating element
- (3) Lower heating element
- (4) Reflectors
- (5) Fireguard
- (6) Fireguard attachment screws
- (7) Power cable and plug

- (8) Control panel
- (9) LCD display
- (10) Standby button
- (11) Shutdown timer button
- (12) Timer countdown button
- (13) Heating mode button
- (14) Up button

- (15) Down button
- (16) Thermostat sensor
- (17) Handle
- (18) Wheel castors
- (19) Wheel locks

## 6.2 What's in the Box?

Carefully remove the product from the packaging and examine it for any signs of damage that may have occurred during shipment.

Before assembling the product, lay the contents out and check them against the parts shown below. If any part is damaged or missing, do not attempt to use the product. Please contact the Draper Helpline; contact details can be found at the back of this manual.

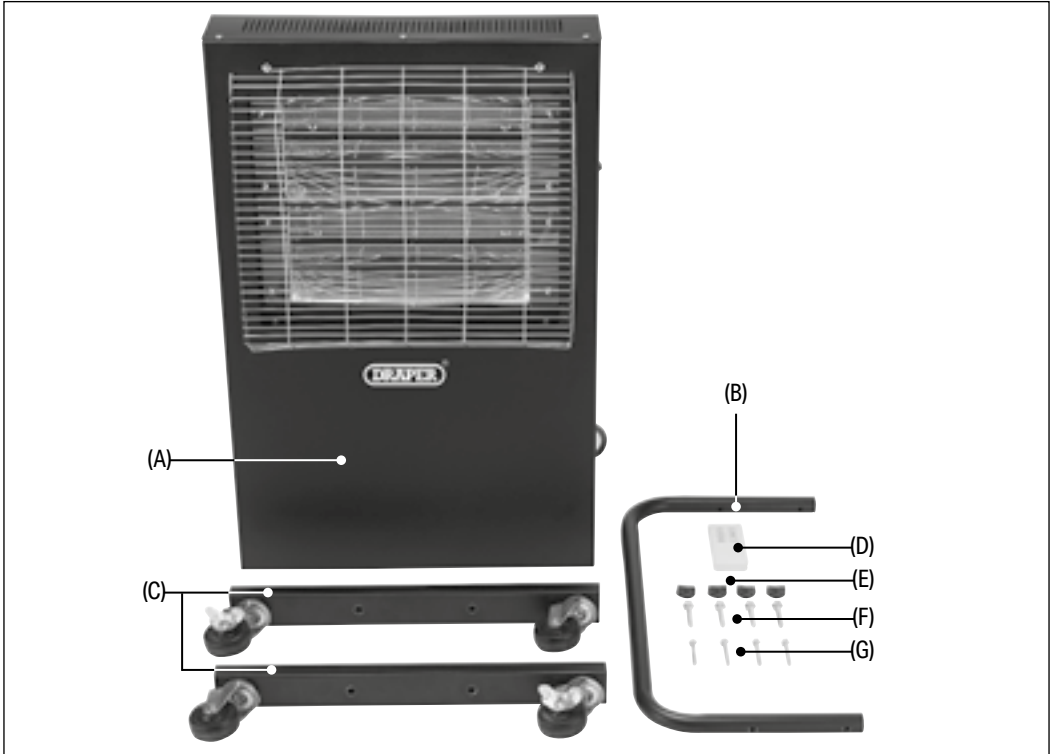

(A) 1 x Infrared heater cabinet

(B) 1 x Handle

(C) 2 x Wheel frames

(D) 1 x Remote control

(E) 4 x Handle mounts

(F) 4 x 14mm x 40mm hex bolts

(G) 4 x M6 x 45mm hex bolts

## 6.3 Packaging

Keep the product packaging for the duration of the warranty period for reference should the product need to be returned for repair.

**WARNING! Keep packaging materials out of reach of children. Dispose of packaging correctly and responsibly and in accordance with local regulations.**

Please visit [drapertools.com](http://drapertools.com) for our full range of accessories and consumables.

# 7. Preparing the Heater

**Important:** Read and understand all the safety instructions listed in this manual before attempting to assemble or use this product.

**⚠ WARNING! Ensure that the product is switched off, disconnected from the power supply and has cooled for least 20 minutes before attempting to assemble, disassemble or move this product.**

## 7.1 Assembly

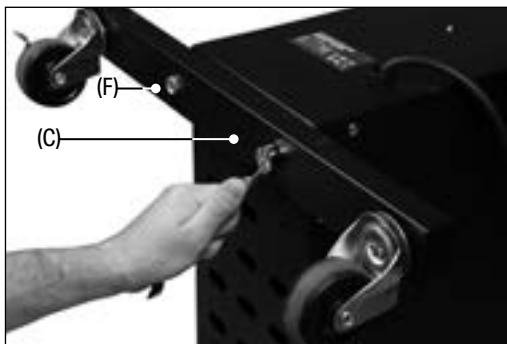

Fig. 1

1. Attach the two wheel frames to the heater unit (Fig. 1).
  - a. Lay the heater on its side so that the power cable and power switch (1) are facing upward.
  - b. Position the wheel frames (C) against the base of the heater so that the holes align.

**Important:** The wheel frames should each run lengthways along the short edge of the heater base.

- c. Screw the 14mm x 40mm hex bolts (F) through the wheel frames and into the heater base.
- d. Stand the heater upright on the wheels.

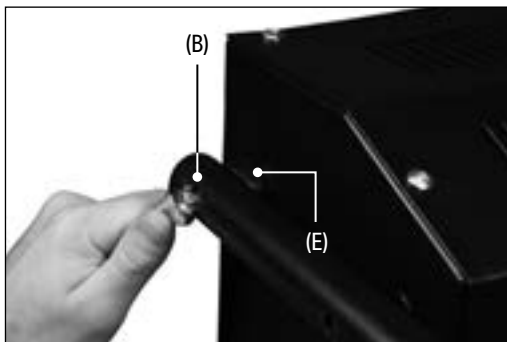

Fig. 2

2. Attach the handle to the heater unit (Fig.2).
  - a. Position the handle (B) so that it extends around the back of the heater and the holes align.
  - b. Position a handle mount (E) between the handle and the heater at each hole.
  - c. Screw the four M6 x 45mm hex bolts (G) through the handle and handle mounts and into the heater.

## 7.2 Positioning the Heater

This heater is intended for use in small, enclosed spaces such as offices, home garages, etc.

Position the unit so that it stands upright unaided on a firm and level surface and is located a safe distance away from flammable objects and wet environments.

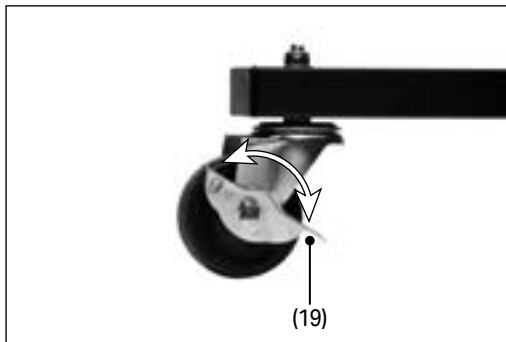

Fig. 3

**Important: ALWAYS** ensure that the wheels are locked when the heater is stationary. To lock each wheel, use your foot to press the "ON" paddle of the wheel lock (19). To release each wheel, press the "OFF" paddle.

Ensure that the power switch (1) is set to the "OFF" position (O), then connect the plug directly to a power outlet.

**⚠ WARNING! ALWAYS switch off the heater, disconnect the power supply and allow it to cool before moving the heater. DO NOT leave the heater unattended while it is connected to the power supply or switched on.**

**Important:** Before use, read and understand all the safety instructions listed in this manual.

**⚠ WARNING! DO NOT leave the heater unattended while it is connected to the power supply or switched on.**

The heater is controlled using the soft-touch control panel (8) on the top of the unit.

## 8.1 Switching on the Heater Power

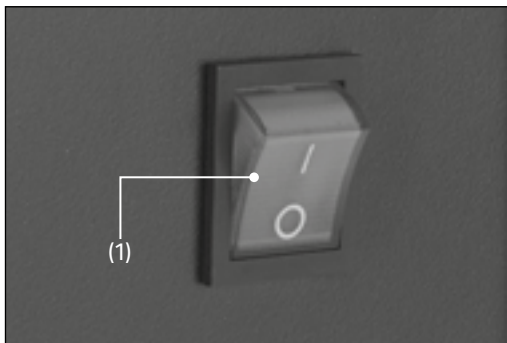

Fig. 4

To switch on the heater power, ensure that it is connected to an active power supply and press the power switch (1) into the "ON" position ( **I** ). The heater enters standby mode and the LCD display (9) illuminates.

## 8.2 Standby Mode and the Default Display

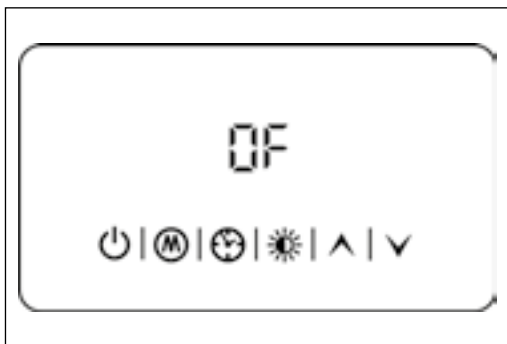

Fig. 5

When the heater is connected to an active power supply and the power switch (1) is moved to the "ON" ( **I** ) position, the heater enters standby mode. While in standby mode, "OF" is shown on the LCD display (9) and neither of the heating elements is active.

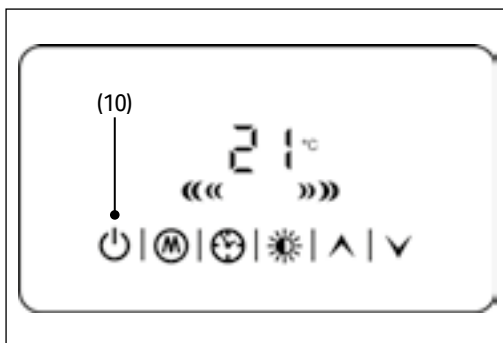

Fig. 6

To switch the heater on from standby mode, press the standby button (10).

- The upper heating element (2) becomes active and begins heating the room to the target temperature.
  - The default target temperature is **30°C**.
  - If the target temperature has been changed, the heater will store the new target temperature while it is on or in standby mode.
  - Turning the heater off using the power switch will cause the target temperature to reset.
- The default display is shown on the LCD display.
  - The current ambient temperature is displayed.
  - If the upper heating element is on, green and yellow heating icons are also displayed.

To return the heater to standby mode after use, press the standby button again.

**Important:** To protect the heater, **ALWAYS** return it to standby mode **BEFORE** turning it off at the power switch. If the heater is not to be used for an extended period, also disconnect it from the power supply.

## 8. Operating Instructions

### 8.3 Enabling the Lower Heating Element

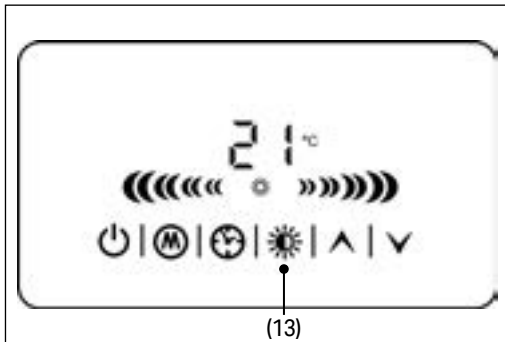

Fig. 7

To enable the lower heating element (3) for faster heating, press the heating mode button (13). A red icon and additional orange and red heating icons are shown on the LCD display (9) while the lower element is active.

**Important:** The lower heating element will only become active if the current ambient temperature is more than 3°C lower than the target temperature.

To disable the lower heating element, press the heating mode button again. The default display is shown.

### 8.4 Setting the Target Temperature

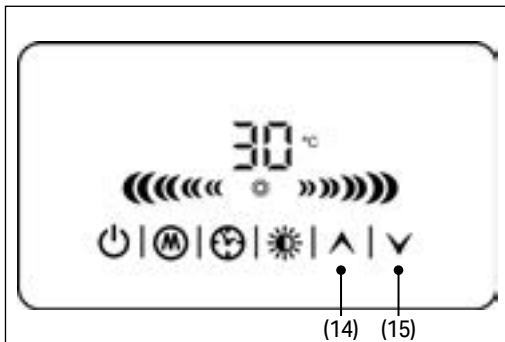

Fig. 8

The default target temperature is 30°C. The heater will automatically attempt to achieve this temperature when switched on from standby mode. If the target temperature has been adjusted, the heater will remember the new target, even in standby mode, until it is switched off using the power switch or at the mains supply. When this occurs, the default target temperature is restored.

The target temperature can be set to any whole value between 15 and 45°C.

To change the target temperature, press the up (14) and down (15) buttons while the default display is shown until the desired temperature is shown on the LCD display (9). The target temperature value is represented by a flashing number on the display. Once the desired target is reached, allow the display to time out and return to the default display.

If the lower heating element has been enabled (see 8.3 **Enabling the Lower Heating Element**), the lower element activates automatically while the current ambient temperature is more than 3°C lower than the target temperature. Once the ambient temperature is less than 3°C lower than the target temperature, the lower element automatically switches off.

**Important:** The lower heating element will only switch on if it has been enabled.

**Important:** The upper heating element remains active at all times until the heater is returned to standby mode or completely switched off. If the target temperature is set at a lower or equal value to the current ambient temperature, the ambient temperature may still increase slightly due to the active element.

### 8.5 Setting and Initiating the Shutdown Timer

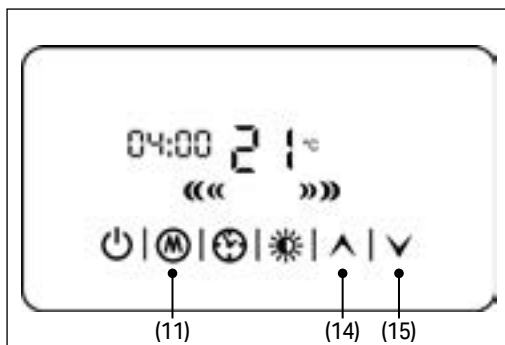

Fig. 9

The heater can be configured to return to standby mode automatically after a specified period. The default timer length is 00:00 (hh:mm). If the shutdown timer has been adjusted, the heater will remember the configured timer length, even in standby mode, until it is switched off using the power switch or at the mains supply.

1. While the default display is shown, press the shutdown timer button (11) to illuminate the timer on the LCD display (9).

- While the clock is flashing, use the up (14) and down (15) buttons to select the number of hours for which the countdown will run.

**Important:** ONLY the hour value can be changed. The maximum value is **23:00**.

- Once the desired value has been reached, allow the display to time out and return to the default display.

**Important:** Once set, the shutdown timer is not visible until it is initiated.

- To initiate the shutdown timer, press the timer countdown button (12).
- The timer is shown on the LCD display and will count down to **00:00**.
- When **00:00** is reached, the heater automatically enters standby mode.

**Important:** Once initiated, the timer can only be reset by completely switching off the heater. Any other action will cause the heater to store the current timer value.

To pause the timer once initiated, press the timer countdown button. To resume the countdown, press the countdown timer button again.

To edit the timer once initiated, press the shutdown timer button. The timer can be adjusted while the countdown is active or paused. If the timer is adjusted while the countdown is active, it will automatically resume once the edit function has timed out.







**Important:** When edited during an active countdown, the minutes value cannot be changed. To reset the minute value to **00**, allow the current timer to expire or fully switch off the heater.

## 8.6 Using the Remote Control



Fig. 10

The heater is supplied with a remote control (D) with buttons that are identical to those on the control panel (8):

Button icon	Function
	Decrease the target temperature or shutdown timer value
	Increase the target temperature or shutdown timer value
	Access the shutdown timer configuration
	Initiate the shutdown timer
	Enable the lower heating element
	Put the heater into or out of standby mode

## 8. Operating Instructions

---

### 8.7 Automatic Power Cut-Outs

The heater is equipped with three features that will automatically initiate standby mode under specific circumstances:

<b>Feature</b>	<b>Shutdown conditions</b>
Shutdown timer	The heater enters standby mode when the timer reaches 00:00 once initiated.
Tilt switch	The heater enters standby mode if the unit is tilted either forward or backward by an angle of 25° or greater in order to protect the ground from heat damage.
Open window detection	If the ambient temperature drops more than 5°C within 10 minutes, the heater beeps three times and automatically enters standby mode in order to save energy when external forces are impacting on the temperature.

In all cases, if the heater enters standby mode automatically, the following settings are impacted:

- The target temperature is reset to the default value.
- The shutdown timer value is retained.
- The current timer value is retained.

Press the standby button to switch the heater back on.

**Important:** Read all the Health and Safety information in this manual before attempting to maintain this product. All maintenance should be carried out **ONLY** by authorised and suitably qualified personnel.

**⚠ WARNING! ALWAYS ensure that the wheels are locked and that the heater is switched off, disconnected from the power supply and has fully cooled before attempting any maintenance on this product.**

## 9.1 General Maintenance and Storage

- Keep the heater clean and dry.
  - Clean the heater body using a dry cloth **ONLY**.
  - Clean the heater reflectors using a dry cloth **ONLY**; see section 9.3 **Cleaning the Reflectors**
  - Clean the heater grilles using a dry cloth or brush, ensuring that all dust and debris is collected and removed from the heater.
- Any maintenance to the plug and power cable **MUST** be carried out by Draper Tools or its authorised representative.
- Any repairs to the heater must be carried out by suitably qualified personnel.
- The heater should be inspected at least once a year by suitably qualified personnel.
- Store the heater in a clean and dry location, out of reach of children.

## 9.2 Removing and Replacing the Fireguard

The fireguard (5) must be removed to access the heating elements and reflectors for maintenance.

1. To remove the fireguard:

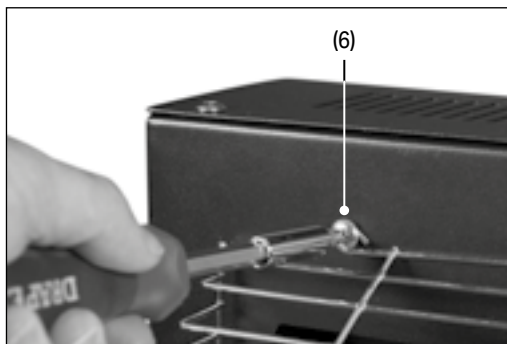

Fig. 11

- a. Unscrew and remove the fireguard attachment screws (6).

- b. Tilt the fireguard forwards and slide the stems out of the retaining holes.
2. To reinstall the fireguard:
    - a. Insert the protruding stems at the base of the guard into the retaining holes beneath the heater opening.
    - b. Tilt the fireguard upwards until the loops at the top of the guard align with the openings above the heater opening.
    - c. Screw the fireguard attachment screws through the loops to secure it in place.

## 9.3 Cleaning the Reflectors

The heater reflectors should be kept clear of dust, debris and other obstructions in order to prevent damage to the heating elements.

To clean the reflectors, remove the fireguard (see 9.2 **Removing and Replacing the Fireguard**) and wipe them gently with a fine dry cloth. Replace the fireguard when complete.

**CAUTION! The surface of the reflectors is very soft. DO NOT use abrasive materials or solvents to clean the reflectors as scratches or corrosion damage may cause the unit to overheat.**

## 9. Maintenance and Troubleshooting

### 9.4 Replacing the Heating Elements

**Important:** This product is not supplied with replacement elements. Contact Draper Tools to discuss replacement options.

**⚠ WARNING! ALWAYS ensure that the heater is disconnected from the power supply and has cooled thoroughly before attempting to access and maintain the heating elements.**

**CAUTION! DO NOT touch the glass of the heating elements with your bare skin, even when cold, as this may damage the element when it is heated. Handle the element using ONLY the caps and cables at either end.**

1. Remove the fireguard (see **9.2 Removing and Replacing the Fireguard**).



Fig. 12

2. Unscrew and carefully remove the reflectors (4) at either side of the element to be changed (Fig.12).

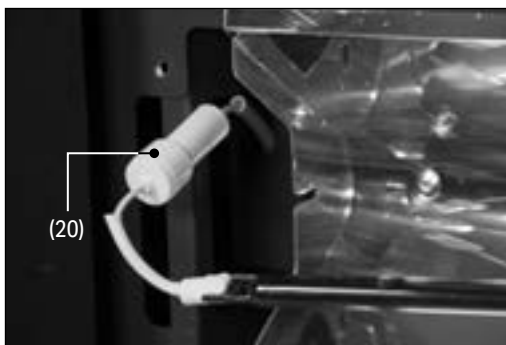

Fig. 13

3. Gently ease the element out of the reflector slots and slide the connection insulators (20) from their sockets and towards you (Fig.13).

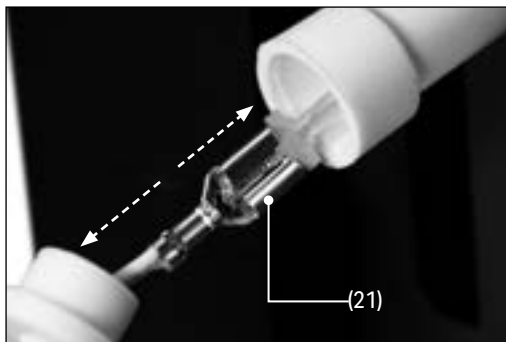

Fig. 14

4. Open the insulators and move both parts away from each other to expose the spade connector (21) (Fig.14).

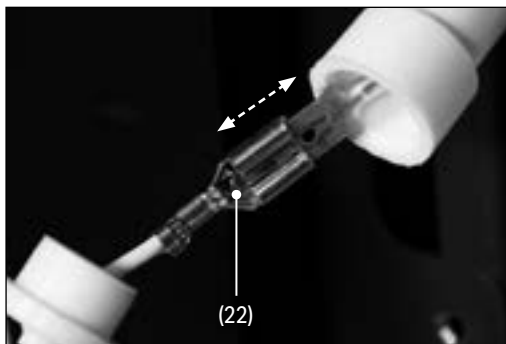

Fig. 15

5. Locate the connector locking tab (22) and press it firmly while gently pulling the connectors apart. Complete these steps for both ends of the element.
6. Remove the element and connect a new element in its place.
7. Push the parts of the connection insulators back together and position the complete insulators centrally along the cable.
8. Carefully push the insulators back into their sockets in the heater frame and slide the tapered ends of the element into the slots of the reflector.
9. Slide the reflectors back into place around the element ends and screw them into place.
10. Reinstall the fireguard (see **9.2 Removing and Replacing the Fireguard**).

## 9.5 Troubleshooting

Problem	Possible cause	Remedy
The heater does not operate when switched on.	The power supply is not active.	Ensure that the power supply to which the heater is connected is switched on.
	The plug or cable connection is loose or damaged.	Remove the plug from the power supply and check it for damage or loose parts.
	The control panel is damaged.	Disconnect the heater <b>IMMEDIATELY</b> and <b>DO NOT</b> use the product. Contact Draper Tools for repair and replacement options.
	One or more of the heating elements is damaged.	Disconnect the heater <b>IMMEDIATELY</b> and allow it to cool before replacing the element (see 9.4).
	The tilt switch has not reset itself.	Allow the heater to cool and tilt it more than 25° in the opposite direction to that which triggered the automatic shutdown. The tilt switch makes an audible click when it is reset.
The heater does not emit any heat.	One or more of the heating elements is damaged.	Check the heating elements for damage and replace them as necessary; see 9.4.
The ambient room temperature value is significantly inaccurate.	The thermostat sensor or connection is faulty.	Contact Draper Tools for repair or replacement options.

## 10. Returns and Disposal

---

For servicing, repair and replacement options, please contact the Draper Tools Product Helpline for details of your nearest authorised agent. Any servicing or repairs carried out by unauthorised personnel will invalidate your warranty.

At the end of its working life, dispose of the product responsibly and in line with local regulations. Recycle where possible.

**DO NOT** dispose of this product with domestic waste; most local authorities provide appropriate recycling facilities.



# 11. Explanation of Symbols



Read the instruction manual



**DO NOT** abandon in the environment



Keep out of the reach of children



Rated voltage (04745)



Rated voltage (04746)



Rated input (04745)



Rated input (04746)



Rated heat output (04745)



Rated heat output (04746)



**DO NOT** cover



**WARNING!/CAUTION**



**WARNING!** Heated surfaces



**WARNING!** Risk of shock



Do not incinerate or throw onto fire



For indoor use only.  
**DO NOT** expose to rain



Earthed



WEEE-

Waste Electrical & Electronic Equipment  
Do not dispose of Waste Electrical & Electronic Equipment  
in with domestic rubbish



UK Conformity Assessed



European conformity

## Contact Details

### **Draper Tools**

Draper Tools Limited  
Hursley Road  
Chandler's Ford  
Eastleigh  
Hampshire  
SO53 1YF  
UK

**Website:** [drapertools.com](http://drapertools.com)

**Email:** [sales@drapertools.com](mailto:sales@drapertools.com)

**Product Helpline:** +44 (0) 23 8049 4344

**Telephone Sales Desk:** +44 (0) 23 8049 4333

**General Enquiries:** +44 (0) 23 8026 6355

**General Fax:** +44 (0) 23 8026 0784

### **Delta International**

Delta International BV  
Oude Graaf 8  
6002 NL  
Weert  
Netherlands

Please contact the Draper Tools Product Helpline for repair and servicing enquiries.