



DRAPER[®]

230V 135/165BAR
**PRESSURE
WASHER**

98676, 98677



These instructions accompanying the product are the original instructions. This document is part of the product, keep it for the life of the product passing it on to any subsequent holder of the product. Read all these instructions before assembling, operating or maintaining this product.

This manual has been compiled by Draper Tools describing the purpose for which the product has been designed, and contains all the necessary information to ensure its correct and safe use. By following all the general safety instructions contained in this manual, it will ensure both product and operator safety, together with longer life of the product itself.

All photographs and drawings in this manual are supplied by Draper Tools to help illustrate the operation of the product.

Whilst every effort has been made to ensure the accuracy of information contained in this manual, the Draper Tools policy of continuous improvement determines the right to make modifications without prior warning.

1. TITLE PAGE

1.1 INTRODUCTION:

USER MANUAL FOR: 230V 135/165bar Pressure Washer

Stock No's: 98676,89677

Part No's: PW1600/90D, PW2200/110D

1.2 REVISIONS:

Date first published October 2020.

As our user manuals are continually updated, users should make sure that they use the very latest version.

Downloads are available from: <http://drapertools.com/manuals>

Draper Tools Limited
Hursley Road
Chandler's Ford
Eastleigh
Hampshire
SO53 1YF
UK

Website: drapertools.com

Product Help Line: +44 (0) 23 8049 4344

General Fax: +44 (0) 23 8026 0784

1.3 UNDERSTANDING THIS MANUALS SAFETY CONTENT:

Warning! – Information that draws attention to the risk of injury or death.

Important – Information that draws attention to the risk of damage to the product or surroundings.

1.4 COPYRIGHT © NOTICE:

Copyright © Draper Tools Limited.

Permission is granted to reproduce this publication for personal and educational use only. Commercial copying, redistribution, hiring or lending is prohibited.

No part of this publication may be stored in a retrieval system or transmitted in any other form or means without written permission from Draper Tools Limited.

In all cases this copyright notice must remain intact.

2. CONTENTS

2.1 TABLE OF CONTENTS

1. TITLE PAGE	
1.1 INTRODUCTION:.....	2
1.2 REVISIONS:.....	2
1.3 UNDERSTANDING THIS MANUALS SAFETY CONTENT:.....	2
1.4 COPYRIGHT © NOTICE:.....	2
2. CONTENTS	
2.1 TABLE OF CONTENTS	3
3. WARRANTY	
3.1 WARRANTY	4
4. INTRODUCTION	
4.1 SCOPE.....	5
4.2 SPECIFICATION.....	5
4.3 HANDLING AND STORAGE.....	5
5. HEALTH AND SAFETY INFORMATION	
5.1 GENERAL SAFETY INSTRUCTIONS FOR POWER TOOL USE	6
5.2 ADDITIONAL SAFETY INSTRUCTIONS FOR PRESSURE WASHER USE	7
5.3 RESIDUAL RISK.....	8
5.4 CONNECTION TO THE POWER SUPPLY.....	8
6. TECHNICAL DESCRIPTION	
6.1 IDENTIFICATION.....	9
7. UNPACKING AND CHECKING	
7.1 PACKAGING	10
7.2 WHAT'S IN THE BOX	10
8. ASSEMBLY	
8.1 FITTING THE TRANSPORT HANDLE SECTION	11
8.2 FITTING THE LANCE HOLDER AND CABLE HOOK	11
8.3 ATTACHING THE LANCE.....	12
8.4 ATTACHING THE NOZZLES TO THE LANCE	12
8.5 ATTACHING THE INTEGRATED HOSE REEL	13
8.6 ATTACHING THE HIGH PRESSURE HOSE.....	13
8.7 CONNECTING THE WATER SUPPLY	14
9. ACCESSORIES	
9.1 DETERGENT BOTTLE	15
9.2 INTEGRATED DETERGENT BOTTLE	15
9.3 TURBO NOZZLE	16
9.4 FIXED BRUSH.....	16
10. OPERATION	
10.1 TOTAL STOP DEVICE.....	17
10.2 SWITCHING ON	17
11. MAINTENANCE AND TROUBLESHOOTING	
11.1 TROUBLESHOOTING GUIDE.....	18
11.2 CLEANING PIN – FIG.24.....	18
11.3 BLEEDING AIR FROM THE SYSTEM.....	18
12. DISPOSAL	
12.1 DISPOSAL	19
13. EXPLANATION OF SYMBOLS	
13.1 EXPLANATION OF SYMBOLS.....	20

3. WARRANTY

3.1 WARRANTY

Draper tools have been carefully tested and inspected before shipment and are guaranteed to be free from defective materials and workmanship.

Should the tool develop a fault, please return the complete tool to your nearest distributor or contact:

Draper Tools Limited, Chandler's Ford, Eastleigh, Hampshire, SO53 1YF. England.

Telephone Sales Desk: +44 (0) 8049 4333 or Product Help Line +44 (0) 23 8049 4344.

A proof of purchase **must** be provided with the tool.

If upon inspection it is found that the fault occurring is due to defective materials or workmanship, repairs will be carried out free of charge. This warranty period covering labour is 12 months from the date of purchase except where tools are hired out when the warranty period is 90 days from the date of purchase. The warranty is extended to 24 months for parts only. This warranty does not apply to any consumable parts, any type of battery or normal wear and tear, nor does it cover any damage caused by misuse, careless or unsafe handling, alterations, accidents, or repairs attempted or made by any personnel other than the authorised Draper warranty repair agent.

Note: If the tool is found not to be within the terms of warranty, repairs and carriage charges will be quoted and made accordingly.

This warranty applies in lieu of any other warranty expressed or implied and variations of its terms are not authorised.

Your Draper warranty is not effective unless you can produce upon request a dated receipt or invoice to verify your proof of purchase within the warranty period.

Please note that this warranty is an additional benefit and does not affect your statutory rights.

Draper Tools Limited.

4. INTRODUCTION

4.1 SCOPE

Compact, lightweight and mobile pressure washer for cleaning vehicles, caravans, motor vans, driveways, boats and other domestic duties. Any other application is considered misuse.

4.2 SPECIFICATION

Stock No	98676	98677
Part No	PW1600/90D	PW2200/110D
Rated voltage	230V~50Hz	230V~50Hz
Rated input	1600W	2200W
Working pump pressure	90bar (1305psi)	110bar (1595psi)
Max. pump pressure	135bar (1958psi)	165bar (2393psi)
Max. flow rate	7.1L/min (426L/hour)	8.2L/min (492L/hour)
Type of protection	IPX5	IPX5
Max. water feed temperature	50°C	50°C
Sound pressure level (LpA)	77dB(A)	77dB(A)
Sound power level (LWA)	93dB(A)	94dB(A)
Uncertainty (K)	3dB(A)	3dB(A)
Vibration level†:	2.5m/s ²	2.5m/s ²
Weight (machine and accessories)	8kg	11kg

4.3 HANDLING AND STORAGE

Note: Every machine is tested in its operating conditions, so it is normal for a few drops of water to be left inside it.

- This pressure washer and accompanying accessories should not be stored at, or below 0°C.
- Frozen water inside the machine can cause critical damage to pump and other components.
- Care must be taken when handling this product.
 - Dropping this power tool could have an effect on its accuracy and could also result in personal injury. This product is not a toy and must be respected.
- Environmental conditions can have a detrimental effect on this product if neglected.
 - Exposure to damp air can gradually corrode components. If the product is unprotected from dust and debris, components will become clogged.
 - If not cleaned and maintained correctly or regularly, the machine will not perform at its best.

5. HEALTH AND SAFETY INFORMATION

5.1 GENERAL SAFETY INSTRUCTIONS FOR POWER TOOL USE

When using any type of power tool there are steps that should be taken to make sure that you, as the user, remain safe.

Common sense and a respect for the tool will help reduce the risk of injury.

Read the instruction manual fully. Do not attempt any operation until you have read and understood this manual.

Most important you must know how to safely start and stop this machine, especially in an emergency.

Keep the work area tidy and clean. Attempting to clear clutter from around the machine during use will reduce your concentration. Mess on the floor creates a trip hazard. Any liquid spilt on the floor could result in you slipping.

Find a suitable location. If the machine is bench mounted, the location should provide good natural light or artificial lighting as a replacement. Avoid damp and dust locations as it will have a negative effect on the machine's performance. If the machine is portable do not expose the tool to rain. In all cases do not operate power tools near any flammable materials.

Keep bystanders away. Children, onlookers and passers by must be restricted from entering the work area for their own protection. The barrier must extend a suitable distance from the tool user.

Unplug and house all power tools that are not in use. A power tool should never be left unattended while connected to the power supply. They must be housed in a suitable location, away locked up and from children. This includes battery chargers.

Do not overload or misuse the tool. All tools are designed for a purpose and are limited to what they are capable of doing. Do not attempt to use a power tool (or adapt it in any way) for an application it is not designed for. Select a tool appropriate for the size of the job. Overloading a tool will result in tool failure and user injury. This covers the use of accessories.

Dress properly. Loose clothing, long hair and jewellery are all dangerous because they can become entangled in moving machinery. This can also result in parts of body being pulled into the machine. Clothing should be close fitted, with any long hair tied back and jewellery and neck ties removed. Footwear must be fully enclosed and have a non-slip sole.

Wear personal protective equipment (PPE). Dust, noise, vibration and swarf can all be dangerous if not suitably protected against. If the work involving the power tool creates dust or fumes wear a dust mask. Vibration to the hand, caused by operating some tools for longer periods must be protected against. Wear vibration reducing gloves and allow long breaks between uses. Protect against dust and swarf by wearing approved safety goggles or a face shield. These are some of the more common hazards and preventions, however, always find out what hazards are associated with the machine/work process and wear the most suitable protective equipment available.

Do not breathe contaminated air. If the work creates dust or fumes connect the machine (if possible) to an extraction system either locally or remotely. Working outdoors can also help if possible.

Move the machine as instructed. If the machine is hand held, do not carry it by the power supply cable. If the product is heavy, employ a second or third person to help move it safely or use a mechanical device. Always refer to the instructions for the correct method.

Do not overreach. Extending your body too far can result in a loss of balance and you falling. This could be from a height or onto a machine and will result in injury.

Maintain your tools correctly. A well maintained tool will do the job safely. Replace any damaged or missing parts immediately with original parts from the manufacturer. As applicable, keep blades sharp, moving parts clean, oiled or greased, handles clean, and emergency devices working.

5. HEALTH AND SAFETY INFORMATION

Wait for the machine to stop. Unless the machine is fitted with a safety brake, some parts may continue to move due to momentum. Wait for all parts to stop, then unplug it from the power supply before making any adjustments, carrying out maintenance operations or just finishing using the tool.

Remove and check setting tools. Some machinery requires the use of additional tools or keys to set, load or adjust the power tool. Before starting the power tool always check to make certain they have been removed and are safely away from the machine.

Prevent unintentional starting. Before plugging any machine in to the power supply, make sure the switch is in the OFF position. If the machine is portable, do not hold the machine near the switch and take care when putting the machine down, that nothing can operate the switch.

Carefully select an extension lead. Some machines are not suitable for use with extension leads. If the tool is designed for use outdoors, use an extension lead also suitable for that environment. When using an extended lead, select one capable of handling the current (amps) drawn by the machine in use. Fully extend the lead regardless of the distance between the power supply and the tool. Excess current (amps) and a coiled extension lead will both cause the cable to heat up and can result in fire.

Concentrate and stay alert. Distractions are likely to cause an accident. Never operate a power tool if you are under the influence of drugs (prescription or otherwise), including alcohol or if you are feeling tired. Being disorientated will result in an accident.

Have this tool repaired by a qualified person. This tool is designed to conform to the relevant international and local standards and as such should be maintained and repaired by someone qualified, using only original parts supplied by the manufacturer. This will ensure the tool remains safe to use.

5.2 ADDITIONAL SAFETY INSTRUCTIONS FOR PRESSURE WASHER USE

Warning!

- This appliance is for outdoor use only.
- Always disconnect the electricity and water supplies on completion of every job.
- Never use the appliance if the electrical cable or important parts of the appliance are damaged, e.g. safety devices, high pressure hose, gun, etc.
- This appliance has been designed for use with a neutral shampoo based on biodegradable anionic surface active detergents. The use of other detergents or chemicals may put the appliance's safety at risk.
- Never use the appliance with people in the vicinity, unless they are wearing protective clothing.
- Do not direct the nozzle toward mechanical parts containing lubricant grease, as the grease will dissolve and spread over the surrounding ground. Vehicle tyres/tyre valves may only be cleaned from a minimum distance of 30cm, otherwise the vehicle tyre/tyre valve could be damaged by the high-pressure jet. The first indication of this is a discolouration of the tyre. Damaged vehicle tyres/tyre valves can be deadly dangerous.
- High pressure jets may be dangerous if improperly used. Jets must never be pointed at people, animals, live electrical equipment or the appliance itself.
- The hoses, accessories and high pressure couplings are important for the appliance's safety. Use only hoses, accessories and couplings recommended (it is extremely important to protect these components against damage by avoiding their improper use and protecting them against bending, knocks and scratches).
- The gun is fitted with a safety catch. Whenever use of the machine is interrupted it is important to operate the safety catch to prevent accidental activation of the jet.
- Never point the jet at yourself or others to clean clothing or footwear.
- Never allow children or untrained people to use the appliance.

5. HEALTH AND SAFETY INFORMATION

- The safety button on the gun is not there to lock the lever during operation, but to prevent its accidental operation.
- Appliances equipped with Total Stop System: these appliances should not be left in standby for more than 5 minutes.
- Switch the appliance off completely (master switch ON/OFF) whenever it is left unattended.
- Take care not to damage the electric cable. Have a damaged power cord replaced immediately by an authorized service point or an electrical specialist.
- The high pressure hose is designed and produced to withstand high pressures. To avoid damage, it must be handled with special care. Misuse may lead to premature breakages or damage and cause the loss of warranty cover.
- Never start the high-pressure cleaner without first completely unwinding the high-pressure hose.
- When winding and unwinding the hose take care not to cause the high pressure cleaner to overturn.
- Before unwinding or winding the hose, switch the machine off and release the pressure in the hose itself (switching off).

5.3 RESIDUAL RISK

Important: Although the safety instructions and operating manuals for our tools contain extensive instructions of safe working with power tools, every power tool involves a certain residual risk which can not be completely excluded by safety mechanisms. Power tools must therefore always be operated with caution!

5.4 CONNECTION TO THE POWER SUPPLY

Caution: Risk of electric shock. Do not open.

This appliance is supplied with an approved plug and cable for your safety. The value of the fuse fitted is marked on the pin face of the plug. Should the fuse need replacing, ensure the substitute is of the correct rating, approved to BS1362 and ASTA or BS Kite marked.

ASTA 

BSI 

The fuse cover is removable with a small plain slot screwdriver. Ensure the fuse cover is replaced before attempting to connect the plug to an electrical outlet. If the cover is missing, a replacement must be obtained or the plug replaced with a suitable type.

If a replacement plug is to be fitted this must be carried out by a qualified electrician.

The damaged or incomplete plug, when cut from the cable should be disabled to prevent connection to a live electrical outlet.

This appliance is Class II† and is designed for connection to a power supply matching that detailed on the rating label and compatible with the plug fitted.

If an extension lead is required, use an approved and compatible lead rated for this appliance. Follow all the instructions supplied with the extension lead.

†*Double insulated* : This product requires no earth connection as supplementary insulation is applied to the basic insulation to protect against electric shock in the event of failure of the basic insulation.

IMPORTANT

If using an extension lead, follow the instructions that came with your lead regarding maximum load while cable is wound. If in doubt, ensure that the entire cable is unwound. Using a coiled extension lead will generate heat which could melt the lead and cause a fire.

6. TECHNICAL DESCRIPTION

6.1 IDENTIFICATION



- | | |
|-----------------------------------|---|
| ① Spray release trigger. | ⑨ Lance section. |
| ② Hose release button. | ⑩ High pressure hose. |
| ③ Transport handle. | ⑪ Cable hook. |
| ④ Lance holder. | ⑫ Trigger assembly section. |
| ⑤ Power supply ON/OFF switch. | ⑬ High pressure hose outlet connection. |
| ⑥ Water inlet connection adaptor. | ⑭ Transport wheels. |
| ⑦ Spray nozzle. | ⑮ Integral hose reel (98677 only). |
| ⑧ Nozzle release button. | ⑯ Integral detergent bottle (98677 only). |

7. UNPACKING AND CHECKING

7.1 PACKAGING

Carefully remove the product from the packaging and examine it for any sign of damage that may have happened during shipping. Lay the contents out and check them against the parts shown below. If any part is damaged or missing, please contact the Draper Help Line (the telephone number appears on the Title page) and do not attempt to use the product.

The packaging material should be retained at least during the warranty period, in case the machine needs to be returned for repair.

Warning!

- Some of the packaging materials used may be harmful to children. Do not leave any of these materials in the reach of children.
- If any of the packaging is to be thrown away, make sure they are disposed of correctly, according to local regulations.

7.2 WHAT'S IN THE BOX

As well as the main product, there are several parts not fitted or attached to it.

Note: For details of our full range of accessories and consumables, please visit drapertools.com



- ③ Transport handle.
- ④ Lance holder.
- ⑥ Water inlet connection adaptor.
- ⑦ Spray nozzle.
- ⑨ Lance.
- ⑩ High pressure hose.
- ⑪ Cable hook.
- ⑫ Trigger assembly section.
- ⑮ Hose reel (98677 only).
- ⑯ Detergent bottle (98676).
- ⑰ Detergent bottle (98677).
- ⑱ Fixed brush.
- ⑲ Turbo nozzle.
- ⑳ Nozzle cleaning pin.
- ㉑ Screws × 2 (98676).
- ㉒ Screws × 4 (98677).

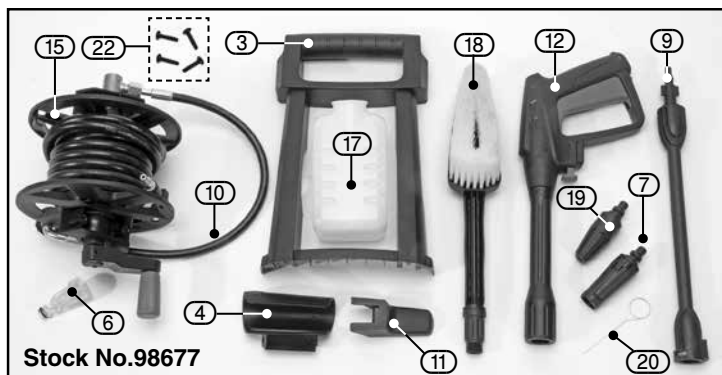

8. ASSEMBLY

8.1 FITTING THE TRANSPORT HANDLE SECTION – FIGS.1 – 2

- Slide the transport handle section (3) over the mounting points (A) at the top of the main body of the pressure washer.
- From the back of the pressure washer, locate the 2 supplied screws (21) with the holes in the mounting points and screw in to secure the handle section in place

8.2 FITTING THE LANCE HOLDER AND CABLE HOOK – FIGS.3 – 4

Attach the lance holder (4) and cable hook (11) at the location points, then slide down over the fittings to secure.

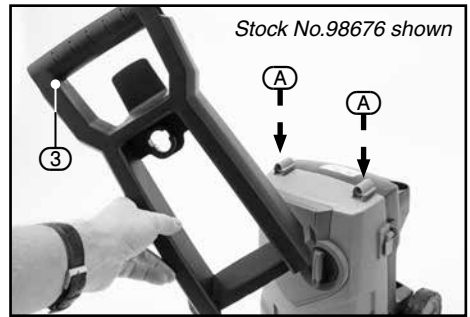

FIG.1

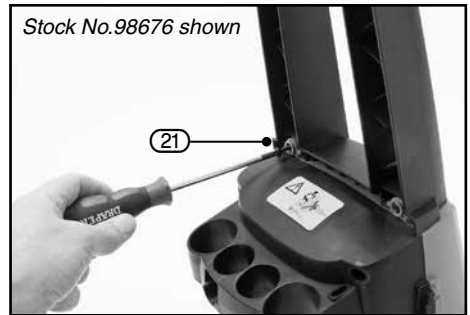

FIG.2

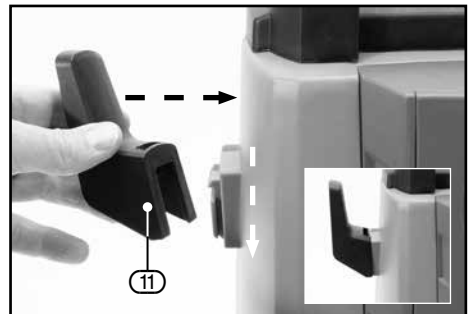

FIG.3

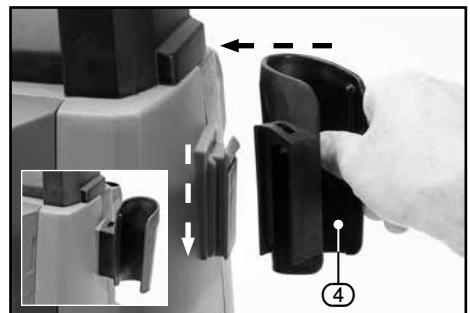

FIG.4

8. ASSEMBLY

8.3 ATTACHING THE LANCE – FIGS.5 – 6

- Connect the lance (9) to the trigger assembly section (12) by pushing in the bayonet fitting and turning anti-clockwise 45° to lock in place.

8.4 ATTACHING THE NOZZLES TO THE LANCE – FIGS.7 – 8

- To connect either the spray nozzle (7) or turbo nozzle (19) to the lance (9), push-fit the nozzle into the end of the lance until it clicks into place. To remove, press the release button (9.1) on the lance to disconnect.

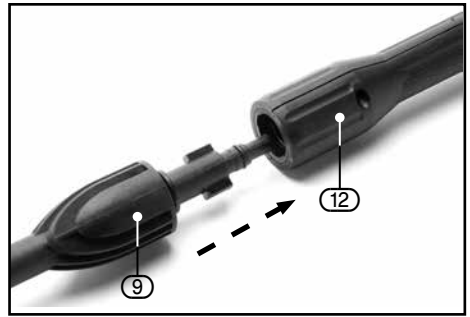

FIG.5

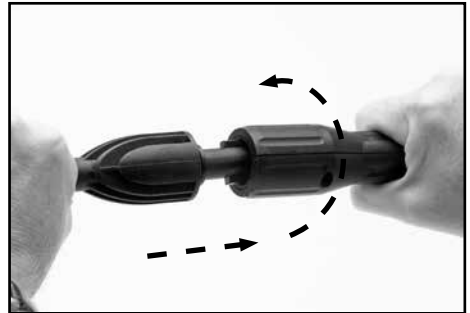

FIG.6

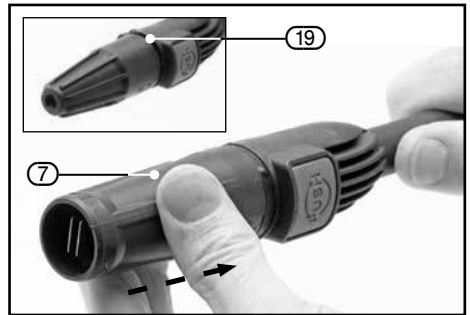

FIG.7

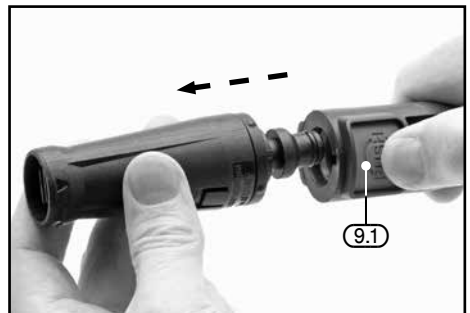

FIG.8

8. ASSEMBLY

8.5 ATTACHING THE INTEGRATED HOSE REEL (98677 only) – FIGS.9 – 10

- Position the hose reel section (15) within the cut out recessed area of the handle section (3).
- Locate the 4 supplied screws (22) with the mounting point holes (B) and screw in to secure the hose reel to the handle.

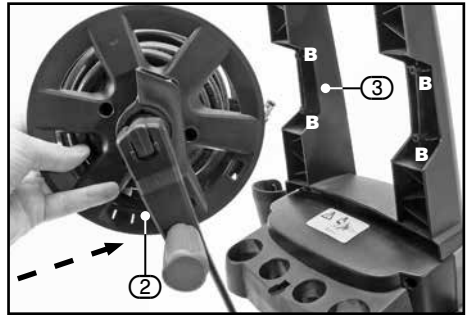

FIG.9

8.6 ATTACHING THE HIGH PRESSURE HOSE – FIGS.11 – 12

- To connect the high pressure hose (10) to the trigger assembly (12), push-fit the hose connector into the inlet on the assembly.
 - Disconnection of the hose is achieved by pressing the hose release button (2).
- Insert the other end of the hose (10) into the high pressure outlet (13) and screw the shrouded end of the hose onto the threaded outer section of the pressure outlet, taking care not to cross the threads.



FIG.10

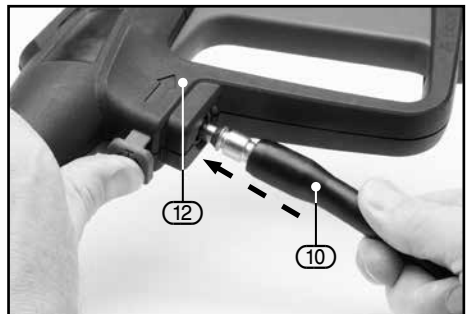

FIG.11

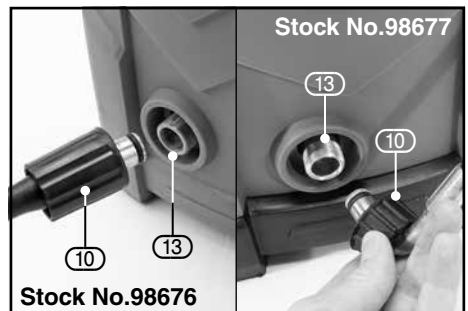

FIG.12

8. ASSEMBLY

8.7 CONNECTING THE WATER SUPPLY – FIGS.13 – 14

- Screw the supplied water inlet adaptor (6) to the water inlet connection (6.1) taking care not to cross the threads.
- To connect the pressure washer to the water supply, a push fit hose connector will be required (FIG.14). Ensure the connector is correctly fitted to the hose and that a 'click' is heard when attaching to the machine.

Note: The supply must be between 1.5bar and 6.0bar and 7 litres/min.

Note: Max. water temp: 40°C.

Note: Always observe local bye-laws and regulations.

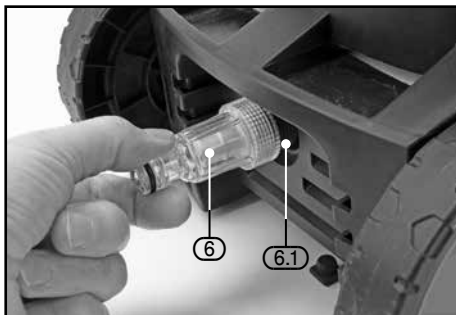

FIG.13

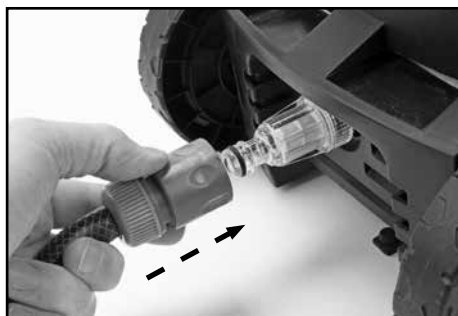

FIG.14

9. ACCESSORIES

9.1 DETERGENT BOTTLE (98676) – FIG.15

- Remove the bottle spray nozzle (16.1) from the detergent bottle (16) and fill the bottle with a suitable detergent, according to the manufacturer's recommended instructions.
- Re-fit the bottle spray nozzle back onto the bottle, then connect the bayonet fitting of the bottle spray nozzle onto the trigger assembly section (12), using the same method as attaching the lance – by pushing in the bayonet fitting and turning anti-clockwise 45° to lock in place.
- The detergent concentration can be adjusted by turning the flow regulator (16.2) located on the end of the nozzle.

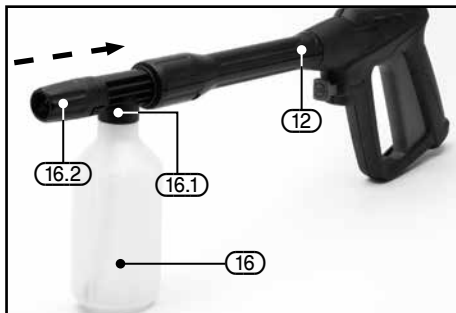

FIG.15

9.2 INTEGRATED DETERGENT BOTTLE (98677) – FIGS.16 – 17

- Remove the cap (17.1) from the detergent bottle (17) and fill the bottle with a suitable detergent, according to the manufacturer's recommended instructions.
- Re-fit the cap back onto the bottle..
- Remove either the spray nozzle (7) or turbo nozzle (19) (if fitted) from the end of the lance (9).
- The detergent and water streams will now automatically mix together.

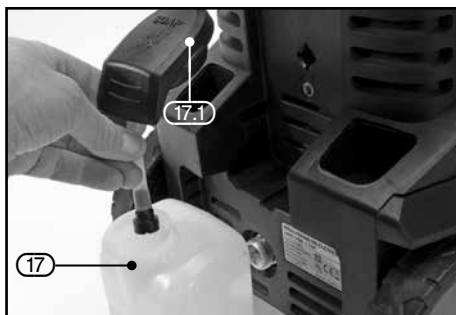

FIG.16



FIG.17

9. ACCESSORIES

9.3 TURBO NOZZLE – FIG.18

The turbo nozzle (19) is a very effective tool that can significantly reduce cleaning times. The turbo nozzle combines the power of a narrow high impact stream and the efficiency of a 25 degree fan pattern. This swirls the narrow high impact stream into a cone shape that cleans a larger area.

Warning! Since a turbo nozzle uses a narrow high impact stream, only use it in applications where the cleaning surface cannot be damaged by narrow high impact spray.

Note: The turbo nozzle is not adjustable and cannot be used to apply detergent.



FIG.18

9.4 FIXED BRUSH – FIG.19

The fixed brush (18) supplied can be used to remove stubborn dirt on a variety of surfaces.

Be aware that foreign matter can get stuck within the bristles of the brush and can scratch the surface being cleaned.

- Connect the bayonet fitting of the fixed brush attachment onto the trigger assembly section (12), using the same method as attaching the lance – by pushing in the bayonet fitting and turning anti-clockwise 45° to lock in place.

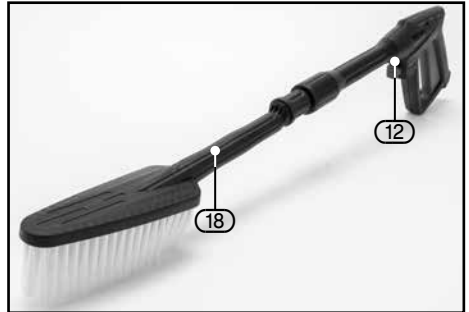

FIG.19

10. OPERATION

10.1 TOTAL STOP DEVICE

This pressure washer is fitted with the **Auto Control Total Stop Device**. This will cause the motor to start and stop when the trigger is activated, unlike standard washers where the motor would run continuously.

This device reduces the amount of water and electricity used and the amount of wear and tear on the machines components. Also this helps cut down on the amount of noise emitted during use.

10.2 SWITCHING ON – FIGS. 20 – 23

Note: Do not run the motor “DRY”, and ensure the machine is switched “OFF” prior to plugging in.

This pressure washer is designed to be used in the upright position only.

To operate the pressure washer correctly carry out the following steps:

- Make sure the power supply ON/OFF switch (5) is set to the “O” – OFF position.
- Connect the pressure washer to the electricity supply outlet.
- Connect and turn on the water supply.

Note: the trigger assembly section contains a safety locking button (12.1) that is used to prevent accidental operation.

- Pull the trigger (1) to bleed the air out of the system.
- Whilst the trigger is pulled switch the power supply ON/OFF switch (5) to the “I” – ON position.
- When the air is purged release the trigger.

The machine is now ready for use. Ensure that during use the jet is not aimed at people, animals, electrical equipment or the pressure washer.

To achieve the desired spray pattern, rotate the spray nozzle (7) (FIG.23).

After use:

- Switch off and unplug the pressure washer.
- Switch off the water supply.
- Pull the trigger to release the pressure and drain the water.
- Disconnect the hose connection.
- Disassemble the lance, trigger and hose from the machine.
- Drain all remaining water and store away safely.

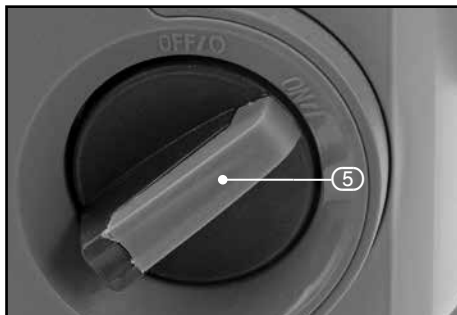

FIG.20

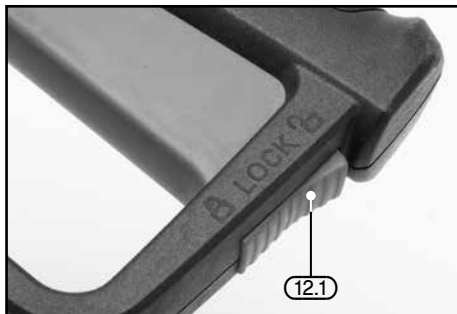

FIG.21

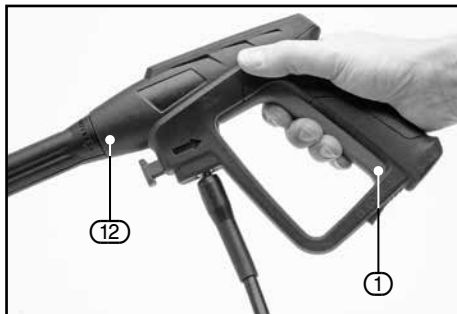

FIG.22



FIG.23

11. MAINTENANCE AND TROUBLESHOOTING

11.1 TROUBLESHOOTING GUIDE

Problem	Possible Cause	Remedy
Motor pulsing.	Air in the system.	See the below section regarding bleeding. procedure (section 11.3).
Pump fails to start.	Plug fuse blown/power supply cable damaged.	Replace fuse/have the cable repaired by an authorised repair agent.
Pump starts/stops with the trigger operation.	Correct operation of the 'Total Stop Device'.	No action required.
Bad spray pattern.	Nozzle blocked.	Unblock nozzle see below.
Poor pressure.	Water leaks.	Check and tighten all the connections.

11.2 CLEANING PIN – FIG.24

Use the cleaning pin (20) to remove foreign matter from the nozzle.

11.3 BLEEDING AIR FROM THE SYSTEM

To bleed any air from the pressure washer system please follow the procedure detailed below:

1. Connect water to water inlet and turn on water.
2. With water outlet pointed in a safe direction turn on the pressure washer.
3. Allow to run for 20 - 30 seconds and then screw on the high pressure hose using the screw adaptor.
4. Pull lance trigger to purge any air from inside the lance.
5. Your pressure washer has now been bled of air.

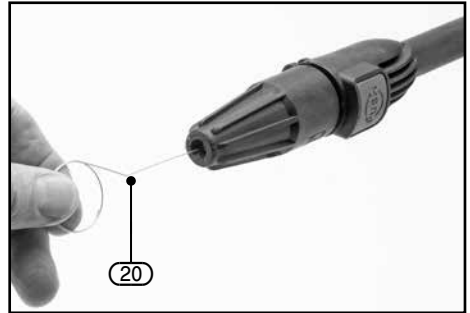

FIG.24

12. DISPOSAL

12.1 DISPOSAL

- At the end of the machine's working life, or when it can no longer be repaired, ensure that it is disposed of according to national regulations.
- Contact your local authority for details of collection schemes in your area.

In all circumstances:

- Do not dispose of power tools with domestic waste.
- Do not incinerate.
- Do not dispose of WEEE* as unsorted municipal waste.



* *Waste Electrical & Electronic Equipment.*

13. EXPLANATION OF SYMBOLS

13.1 EXPLANATION OF SYMBOLS



Read the instruction manual.



Wear face mask and safety glasses.



Wear ear defenders.



Wear protective gloves.



Wear protective footwear.



Do not abandon into the environment.



Keep out of the reach of children.



Warning!



Variable spray nozzle.



Never spray people or animals.



Protect from frost.



WEEE –
Waste Electrical & Electronic Equipment.
Do not dispose of Waste Electrical & Electronic
Equipment in with domestic rubbish.



Continuous A-Weighted Sound
Pressure Level.



Class II construction
(Double insulated).

CONTACTS

Draper Tools Limited, Hursley Road,
Chandler's Ford, Eastleigh, Hampshire. SO53 1YF. U.K.

Help Line: (023) 8049 4344

Sales Desk: (023) 8049 4333

Internet: drapertools.com

E-mail: sales@drapertools.com

General Enquiries: (023) 8026 6355

Service/Warranty Repair Agent:

For aftersales servicing or warranty repairs, please contact the Draper Tools Help Line for details of an agent in your local area.

YOUR DRAPER STOCKIST

TACH1020

©Published by Draper Tools Limited.

No part of this publication may be reproduced, stored in a retrieval system or transmitted in any form or by any means, electronic, mechanical photocopying, recording or otherwise without prior permission in writing from Draper Tools Ltd.