

User Manual of Product 1:

EAST OAK Patio Heater, Wall Mounted & Standing 1500W
Outdoor Indoor Infrared Electric Heater with IP65 Waterproof &
Dustproof, Tip-over & Overheating Protection, 3 Heat Settings
& 24H Timing

User Manual of Product 2:

Outdoor Patio Heater, EAST OAK 1500W Portable Outdoor
Indoor Electric Heater with IP65 Waterproof Tip-over Protection
3 Heat Settings & 24 Hours Timing Tower Infrared Heater for
Garage Restaurant Use

1500W Electric 2-in-1 Wall Mount Patio Heater Owner's Manual

SPH22002

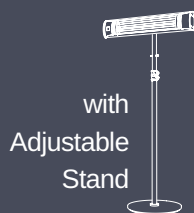
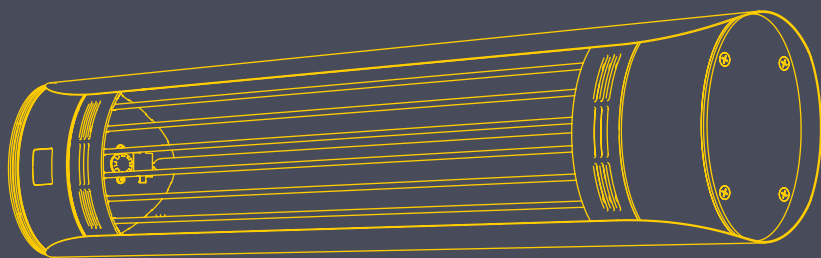

EAST OAK

The first part of the document discusses the importance of maintaining accurate records of all transactions. It emphasizes that every entry, no matter how small, should be recorded to ensure the integrity of the financial data. This includes not only sales and purchases but also expenses and income. The text suggests that a consistent and thorough record-keeping system is essential for identifying trends and making informed decisions.

In the second section, the author addresses the challenges of budgeting and financial planning. It notes that many businesses struggle to stay within their budgets due to unforeseen expenses or changes in market conditions. The document offers several strategies to mitigate these risks, such as creating a contingency fund and regularly reviewing the budget to adjust for any deviations. It also highlights the importance of having a clear financial goal and a realistic timeline for achieving it.

The third part of the document focuses on the role of technology in modern business operations. It discusses how various software solutions, such as accounting systems and CRM tools, can streamline processes and improve efficiency. The text mentions that while technology can be a significant investment, it often pays for itself in the long run by reducing manual errors and saving time. It encourages businesses to explore new technologies and integrate them into their existing workflows.

Finally, the document concludes with a section on the importance of customer service and relationship management. It states that providing excellent customer service is not just a nice-to-have but a critical component of a successful business. The text suggests that businesses should invest in training for their staff and use feedback loops to continuously improve their offerings. It also mentions that strong relationships with customers can lead to repeat business and positive word-of-mouth referrals.

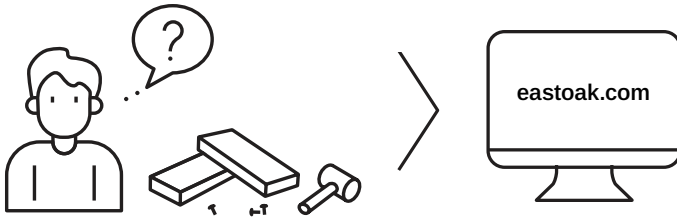

**Question? Comments?
Reach out to us to get expert support!**

✉ support@east oak.com
🌐 east oak.com
☎ 1-833-EAST-OAK (USA)
(1-833-327-8625)

Follow **east oak living** on



Claim 3-year warranty
at east oak.com/warranty

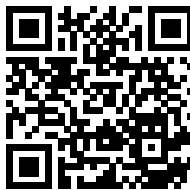

IMPORTANT CAUTION

Please verify all parts and components present and check for any damaged pieces before assembly. If you have any damaged or missing parts, please contact customer service at support@eastoak.com.

- Some parts may contain sharp edges and may cause injury or property damage. We recommend you wear protective gloves during assembly.
- If you are using power tools, please set the speed to the lowest setting possible to ensure there will be no damage to the parts.



IMPORTANT INFORMATION

DANGER

- To avoid any overheating, do not cover this product when it is in use.
- **This appliance shall be used by adults only.** Any child under the age of 8 years old or persons with reduced physical, sensory, or mental capacity may use this product if given proper supervision and instruction concerning the best practices and safety measures of the appliance. Children should not play with or clean this product.

CAUTION

- This product is **extremely hot when in use** and may cause burns, injury, or death. Children and vulnerable people should remain at least 3 feet away from this product.
- This heater cannot control room temperatures. **Do not use this heater in small rooms with children or pets.**
- This heater must not be placed immediately below a socket outlet.
- Do not place this heater close to any combustible items, such as curtains, cloth, gas, or any flammable liquids.

-
- If the cord or plug is damaged, please contact support@eastoak.com to repair and/or replace the part. Do not attempt to operate this heater prior to replacement.
 - Children under 3 years old should stay away from this product when in use unless closely supervised.
 - Children ages 3 to 8 years old shall not operate this appliance, plug or unplug it into the outlet, clean, or perform any maintenance on this product.



SAY HELLO TO THE FUTURE

Our Infrared 2-in-1 Electric Wall Mount Heater offers maximum heat with 90% less light, creating an ambient and pleasurable outdoor experience for all. Its ultra-low glare technology promises instant comfort in a matter of seconds. It can be adjusted to the height you want with the adjustable stand in the package, and the gears can be adjusted by remote control. It can use in open bars, courtyards, plazas, and stations.

Welcome warmth and the perfect amount of heat into your life now with East Oak's Infrared Electric Heater.



SAFETY GUIDE

When using any electrical appliance, including this infrared heater, basic safety precautions must be followed to reduce the risk of fire, shock, or injury. Please read all instructions before using this appliance:

- This heater becomes extremely hot when in use. To minimize risk of burns or injury, do not touch any part of the heater when in use. Allow enough time for product to cool down completely before handling. If applicable, use handles when transporting this product. Keep all combustible items, such as furniture, pillows, bedding, or paper, at least 3 feet away from all sides of the heater.
- Be extremely cautious of surroundings when heater is in use. No children or pets should be close to the product when it is on.
- Ensure heater is unplugged after each use.
- Do not operate this heater if it malfunctions, has been dropped, or any cords or plugs are damaged. Discard heater or send the product to an authorized service facility for inspection and/or repair.
- Do not run the cord under any carpeting, rugs, furniture, or appliances. Ensure the cord is neatly placed away from areas that are high-traffic and may be tripped over.
- Connect to properly grounded outlets only.
- To disconnect the heater, turn the switch to the "OFF" position. Then, remove the plug from the outlet. Allow the product to cool down completely.
- Do not insert any foreign objects into the ventilation system. This may result in a fire, shock, or damage to the heater.
- For fire prevention, do not block any air intakes or exhausts with any items, including newspapers, cloths, or curtains. Do not use this appliance on top of soft surfaces, such as a bed or clothes.
- Do not place any open flame sources on this appliance, such as a lit candle.
- Do not place this appliance near any combustible materials, such as gas, paint, or flammable liquids.
- Only use this heater as described in the manual. Any other use is not recommended by the manufacturer. Be aware that misuse may result in fire, shock, or injury.
- Only plug the heater directly into a grounded outlet with protective connection. Do not use this appliance with an extension cord or power strip.
- Always check the voltage on the name plate of the appliance with the outlet you will be inserting it into.
- The appliance is not located immediately below a wall socket-outlet.

-
- All parts of this heater may become extremely hot when in use. Do not touch the appliance and ensure there is no combustible material around the product. Misuse may result in fire, shock, damage, or injury.
 - In case of an emergency, such as shock or fire, turn off the heater and unplug the appliance immediately. Do not try to repair the product by yourself. Please contact the manufacturer or a qualified electrician.
 - Unplug the appliance and wait until the heater has completely cooled down prior to cleaning or transporting.
 - The appliance must only be mounted by an authorized specialist. Please be aware of any relevant regulations from local electric companies or regional construction organizations.

STORAGE

Do not move, reroute, or wrap cord when heater is in use.

CARE AND MAINTENANCE

- This appliance is designed with a protective aluminum exterior for added durability and low maintenance use. No serviceable parts are included.
- Prior to cleaning your product, unplug the device and wait for it to completely cool down.
- Wipe your product with only a clean, lint-free cloth or a soft bristle brush.
- Do not clean your product with any abrasive cleaners, rough brushes, or chemical products.
- If needed, you may use alcohol to clean this product.
- For your safety, do not immerse the cord, plug, or any part of the product in water or any other liquid.
- If a replacement is needed, please contact the manufacturer or a qualified electrician.
- If a replacement is needed, please contact customer service at support@eastoak.com.





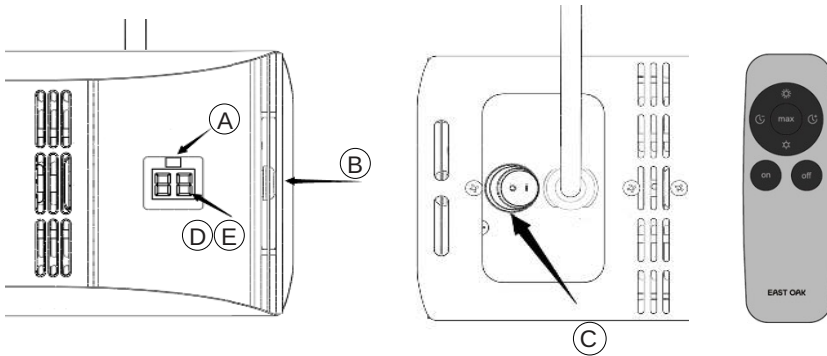

SAVE THESE INSTRUCTIONS

Specifications	
Specification	SPH22002
Voltage (V)	120V 60Hz
Power consumption (W)	1500W
IP code	IP65

FUNCTION INSTRUCTION



Remark	Graphic	Name	Function
A		Through window	Infrared receiving transparent window
B		Manual button	Switch on / off and adjust the power
C		Switch	Turn on the power or Turn off the power
D		LED - LO	<ol style="list-style-type: none"> 1: Display the level setting of the heating (L1,L2,L3). 2: Display timing time (01-24H).
E		LED - FL	<p>FL (Anti-dumping) Mode: During the use, when the dumping angle of the product greater than 10°, it will activate the Anti-dumping Mode. The LED will keeps flicking.</p> <p>How to cancel the FL Mode: Option1: Use the remote control "OFF" to reset the LED, until the screen shows "-, -". Option2: Use the manual button "B" to reset the LED, until the screen shows "-, -". *NOTE: The power is not able to adjust under the FL mode.</p> <p>How to reset the heater: Step1: Place the heater back in the initial level. Step2: Restart the power.</p>

Button	Graphic	Feature
Up Arrow		Up one heating level
Max		The heater goes directly to the highest heating level
Down Arrow		Down one heating level
Timing Key -		1-24h setting, press once to reduce 1 hour, display the remaining time on the screen, and press for a long time to enter the setting mode.
Timing Key +		1-24h setting, press once to increase 1 hour, display the remaining time on the screen, and press for a long time to enter the setting mode.
On		To switch the heater on: Press ON. The patio heater has a soft start function of 50% power, 4 seconds after the heater has been turned on, it will automatically switch to the last heating level used. In case of the first-time use, after 4 seconds the heater will automatically switch to 100% power.
Off		To switch the heater off: Press OFF. The heater will switch to standby mode (the receiver indicator will light up).

REMOTE CONTROL GUIDE

1. Remote control distance works up to 3-4 m.
2. For optimal usage, align the remote to the receiver as illustrated here.

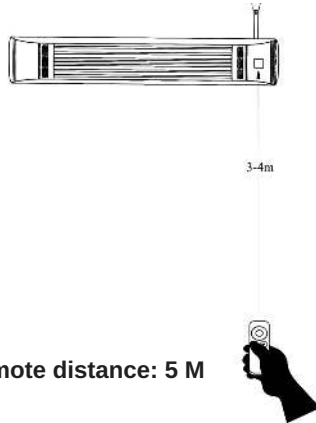

NOTICE

- The remote control works with 2 AAA 1.5V batteries (sold separately). If the appliance will not be in use, remove the batteries from the remote to minimize any risk of damage.
- Ensure only the approved battery sizes is used for the remote. Misuse may result in damage to the remote or unit's function.
- Contact a service technician for additional assistance if needed.
- Remote may not work if there is a physical blockage interfering between the appliance and remote.
- Replace all batteries as needed to ensure proper function of appliance and remote.

1

OPERATION INSTRUCTION

Inspect all components, including the main unit, supply cord, and plugs, for any signs of damage. Take off all screws.

If any parts or hardware pieces are missing or damaged, please contact customer service at support@eastoak.com. In your email, include your shipping address and product information. We will send you replacement parts for free.

Take out the L-shaped bracket from the plastic bag and mount the brackets on the wall with the help of anchor dowels.

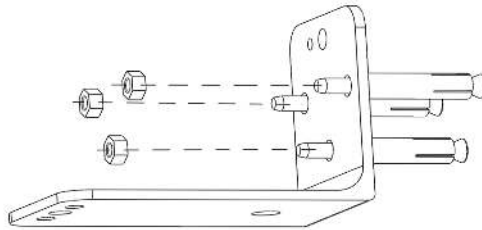

2

Connect the heater to the L-shaped bracket.

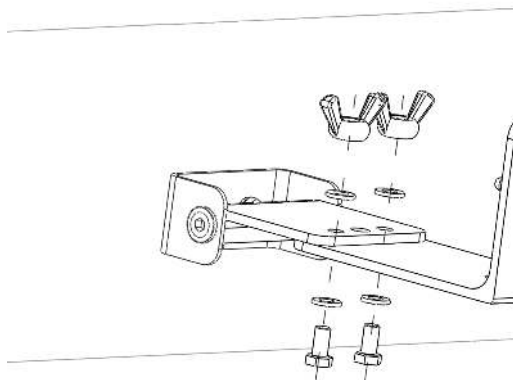

3

Adjust the required angle of the heater, and tighten the T-nut.

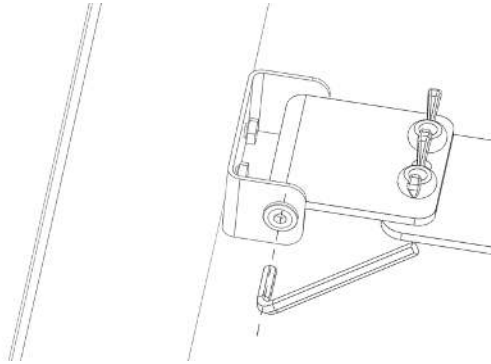

4

- Don't move or cover the heater while it is working.
- Warn that the heater must be installed appropriately before it is used.
- Connect the plug to the socket.
- Turn on the switch and connect the power to check if the heater can work well.
- Plug in the power source and operate the remote control. Then observe whether the appliance works trouble-free during the first 10-15 minutes.
- If you do not use it, please remove the battery socket.
- This heater includes an **Overheat Protection System** that shuts the unit off when parts of the heater overheat. If this occurs, turn the heater off, unplug it, and inspect and remove any objects on or adjacent to the heater that may cause high temperatures. Wait five to ten minutes for the unit to cool down. Then plug it back in, and resume the regular operation.

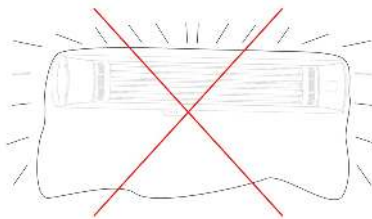

GROUNDING INSTRUCTIONS

This heater is compatible with 120-volt sockets. The plug (A) is shown Figure 60.1. An adapter (C) is available to adapt three-blade plugs to two-slot sockets. The green grounding extension must be connected to a permanent ground, such as an outlet box. The adapter should not be used if a three-slot socket is available.

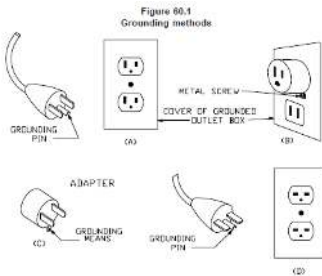

SERVICE

- For your safety, all repairs must be done by an authorized and trained electrician only.
- Please contact the manufacturer or an electrician for your choice.
- Unauthorized repairs may lead to property damage, injury, or death.
- Unauthorized repairs may lead to property damage, injury, or death.
- Our warranty does not cover any damage resulting from unauthorized repairs, accidents, misuse, or maintenance abuse.
- We are committed to continuous product development and we reserve the right to change the product and documentation specifications without notice.
- For any services, please contact customer service at support@eastoak.com.

WARRANTY

GUARANTEED 3-YEAR WARRANTY

Thank you for choosing East Oak. This product is covered by our company warranty for up to 3 years from its original purchase date.

CLAIM WARRANTY

To claim your product's warranty, register your new product on our website at www.eastoak.com/warranty.

The first part of the document discusses the importance of maintaining accurate records in a business setting. It highlights how proper record-keeping can help in identifying trends, making informed decisions, and ensuring compliance with legal requirements. The text emphasizes that records should be organized, up-to-date, and easily accessible to relevant personnel.

Next, the document addresses the challenges associated with data management. It notes that as the volume of data increases, the risk of errors and data loss also increases. Therefore, implementing robust data management practices, such as regular backups and secure storage solutions, is crucial for protecting valuable information.

The document also touches upon the role of technology in record management. It suggests that utilizing digital tools and software can significantly streamline the process, reduce manual errors, and improve the overall efficiency of record-keeping operations.

In conclusion, the document stresses that effective record management is not just a task but a strategic imperative for any organization. By adopting best practices and leveraging technology, businesses can ensure their records are reliable, secure, and useful for long-term success.

EAST OAK

✉ support@eastoak.com
🌐 eastoak.com
☎ 1-833-EAST-OAK (USA)

1500W Electric Tower Patio Heater

Owner's Manual

TPH22002

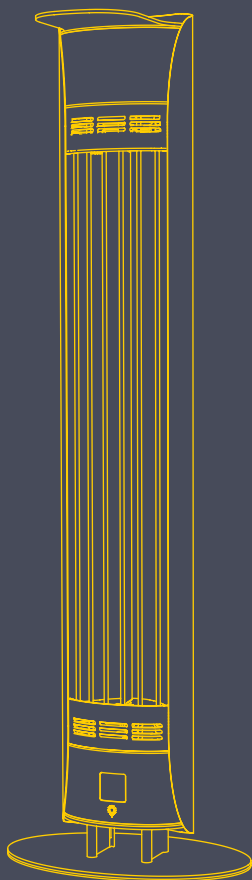

EAST OAK

The first part of the document discusses the importance of maintaining accurate records of all transactions. It emphasizes that every entry, no matter how small, should be recorded to ensure the integrity of the financial data. This includes not only sales and purchases but also expenses and income. The document provides a detailed list of items that should be tracked, such as inventory levels, accounts payable, and accounts receivable. It also outlines the procedures for recording these transactions, including the use of double-entry bookkeeping and the importance of regular reconciliations.

The second part of the document focuses on the analysis of financial statements. It explains how to interpret the balance sheet, income statement, and cash flow statement. It provides a step-by-step guide to calculating key financial ratios, such as the current ratio, debt-to-equity ratio, and return on assets. The document also discusses the significance of these ratios and how they can be used to assess the financial health of a company. It includes several examples of financial statements and their corresponding ratios to illustrate the concepts.

The third part of the document addresses the issue of budgeting and forecasting. It explains how to develop a budget and how to use it to track performance. It discusses the importance of setting realistic goals and how to adjust the budget as needed. The document also provides a detailed guide to forecasting, including the use of historical data and market trends. It includes several examples of budgets and forecasts to illustrate the concepts.

The fourth part of the document discusses the importance of internal controls. It explains how to design and implement effective internal controls to prevent fraud and errors. It provides a detailed list of internal controls that should be in place, such as segregation of duties, authorization requirements, and regular audits. The document also discusses the importance of monitoring and evaluating internal controls to ensure their effectiveness.

The fifth part of the document discusses the importance of tax compliance. It explains how to calculate and pay taxes and how to take advantage of tax deductions and credits. It provides a detailed guide to tax reporting, including the use of tax forms and the importance of keeping accurate records. The document also discusses the importance of staying up-to-date on tax laws and regulations.

The sixth part of the document discusses the importance of financial reporting. It explains how to prepare financial statements and how to present them in a clear and concise manner. It provides a detailed guide to financial reporting, including the use of financial statements and the importance of transparency. The document also discusses the importance of providing accurate and timely financial information to stakeholders.

The seventh part of the document discusses the importance of financial planning. It explains how to develop a financial plan and how to use it to achieve long-term goals. It provides a detailed guide to financial planning, including the use of financial statements and the importance of regular reviews. The document also discusses the importance of staying up-to-date on financial trends and opportunities.

The eighth part of the document discusses the importance of financial risk management. It explains how to identify and assess financial risks and how to develop strategies to mitigate them. It provides a detailed guide to financial risk management, including the use of financial statements and the importance of regular reviews. The document also discusses the importance of staying up-to-date on financial risks and opportunities.

The ninth part of the document discusses the importance of financial communication. It explains how to communicate financial information effectively and how to build trust with stakeholders. It provides a detailed guide to financial communication, including the use of financial statements and the importance of transparency. The document also discusses the importance of staying up-to-date on financial communication trends and opportunities.

The tenth part of the document discusses the importance of financial innovation. It explains how to develop and implement innovative financial solutions and how to stay up-to-date on the latest trends. It provides a detailed guide to financial innovation, including the use of financial statements and the importance of regular reviews. The document also discusses the importance of staying up-to-date on financial innovation trends and opportunities.

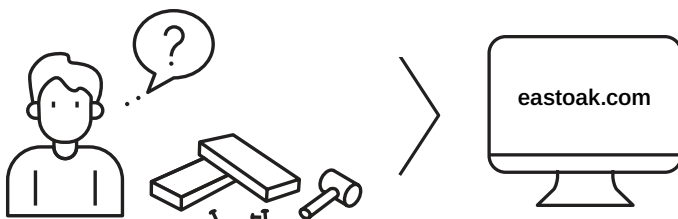

**Question? Comments?
Reach out to us to get expert support!**

✉ support@eastoak.com
🌐 eastoak.com
☎ 1-833-EAST-OAK (USA)
(1-833-327-8625)

Follow **eastoakliving** on



Claim 3-year warranty
at eastoak.com/warranty



IMPORTANT CAUTION

Please verify all parts and components present and check for any damaged pieces before assembly. If you have any damaged or missing parts, please contact customer service at support@eastoak.com.

- Some parts may contain sharp edges and may cause injury or property damage. We recommend you wear protective gloves during assembly.
- If you are using power tools, please set the speed to the lowest setting possible to ensure there will be no damage to the parts.



IMPORTANT INFORMATION

DANGER

- To avoid any overheating, do not cover this product when it is in use.
- **This appliance shall be used by adults only.** Any child under the age of 8 years old or persons with reduced physical, sensory, or mental capacity may use this product if given proper supervision and instruction concerning the best practices and safety measures of the appliance. Children should not play with or clean this product.

CAUTION

- This product is **extremely hot when in use** and may cause burns, injury, or death. Children and vulnerable people should remain at least 3 feet away from this product.
- This heater cannot control room temperatures. **Do not use this heater in small rooms with children or pets.**
- This heater must not be placed immediately below a socket outlet.
- Do not place this heater close to any combustible items, such as curtains, cloth, gas, or any flammable liquids.

-
- If the cord or plug is damaged, please contact support@eastoak.com to repair and/or replace the part. Do not attempt to operate this heater prior to replacement.
 - Children under 3 years old should stay away from this product when in use unless closely supervised.
 - Children ages 3 to 8 years old shall not operate this appliance, plug or unplug it into the outlet, clean, or perform any maintenance on this product.



SAY HELLO TO THE FUTURE

Our Infrared Electric Heater offers maximum heat with 90% less light, creating an ambient and pleasurable outdoor experience for all. Its ultra-low glare technology promises instant comfort in a matter of seconds. And to set up – all you need is at least 5 minutes, because we’ve designed each heater with a patented easy-fit replacement system. Plus, its remote controlled and IP 65 approved.

Welcome warmth and the perfect amount of heat into your life now with East Oak’s Infrared Heater.



SAFETY GUIDE

When using any electrical appliance, including this infrared heater, basic safety precautions must be followed to reduce the risk of fire, shock, or injury. Please read all instructions before using this appliance:

- This heater becomes extremely hot when in use. To minimize risk of burns or injury, do not touch any part of the heater when in use. Allow enough time for product to cool down completely before handling. If applicable, use handles when transporting this product. Keep all combustible items, such as furniture, pillows, bedding, or paper, at least 3 feet away from all sides of the heater.
- Be extremely cautious of surroundings when heater is in use. No children or pets should be close to the product when it is on.
- Ensure heater is unplugged after each use.
- Do not operate this heater if it malfunctions, has been dropped, or any cords or plugs are damaged. Discard heater or send the product to an authorized service facility for inspection and/or repair.
- Do not run the cord under any carpeting, rugs, furniture, or appliances. Ensure the cord is neatly placed away from areas that are high-traffic and may be tripped over.
- Connect to properly grounded outlets only.
- To disconnect the heater, turn the switch to the "OFF" position. Then, remove the plug from the outlet. Allow the product to cool down completely.
- Do not insert any foreign objects into the ventilation system. This may result in a fire, shock, or damage to the heater.
- For fire prevention, do not block any air intakes or exhausts with any items, including newspapers, cloths, or curtains. Do not use this appliance on top of soft surfaces, such as a bed or clothes.
- Do not place any open flame sources on this appliance, such as a lit candle.
- Do not place this appliance near any combustible materials, such as gas, paint, or flammable liquids.
- Only use this heater as described in the manual. Any other use is not recommended by the manufacturer. Be aware that misuse may result in fire, shock, or injury.
- Only plug the heater directly into a grounded outlet with protective connection. Do not use this appliance with an extension cord or power strip.
- Always check the voltage on the name plate of the appliance with the outlet you will be inserting it into.
- The appliance is not located immediately below a wall socket-outlet.

-
- All parts of this heater may become extremely hot when in use. Do not touch the appliance and ensure there is no combustible material around the product. Misuse may result in fire, shock, damage, or injury.
 - In case of an emergency, such as shock or fire, turn off the heater and unplug the appliance immediately. Do not try to repair the product by yourself. Please contact the manufacturer or a qualified electrician.
 - Unplug the appliance and wait until the heater has completely cooled down prior to cleaning or transporting.
 - The appliance must only be mounted by an authorized specialist. Please be aware of any relevant regulations from local electric companies or regional construction organizations.

STORAGE

Do not move, reroute, or wrap cord when heater is in use.

CARE AND MAINTENANCE





- This appliance is designed with a protective aluminum exterior for added durability and low maintenance use. No serviceable parts are included.
- Prior to cleaning your product, unplug the device and wait for it to completely cool down.
- Wipe your product with only a clean, lint-free cloth or a soft bristle brush.
- Do not clean your product with any abrasive cleaners, rough brushes, or chemical products.
- If needed, you may use alcohol to clean this product.
- For your safety, do not immerse the cord, plug, or any part of the product in water or any other liquid.
- If a replacement is needed, please contact the manufacturer or a qualified electrician.
- If a replacement is needed, please contact customer service at support@eastoak.com.



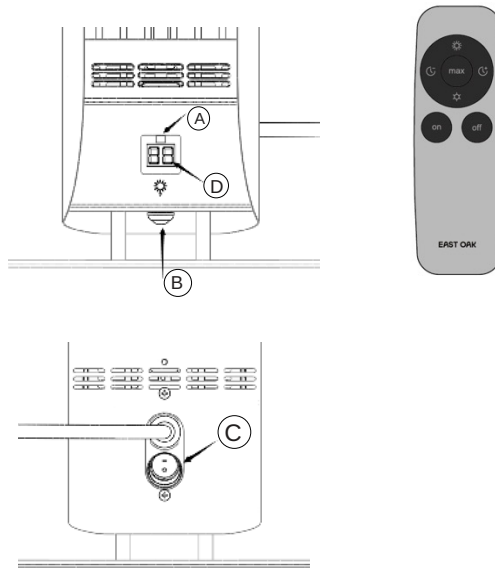



SAVE THESE INSTRUCTIONS

Specifications	
Specification	TPH22002
Voltage (V)	120V 60Hz
Power consumption (W)	1500W
IP code	IP65

FUNCTION INSTRUCTION



Remark	Graphic	Name	Function
A		Through window	Infrared receiving transparent window
B		Manual button	Switch on / off and adjust the power
C		Switch	Turn on the power or Turn off the power
D		LED screen	<ol style="list-style-type: none"> 1: Display the level setting of the heating (L1,L2,L3) 2: Display timing time (01-24H) 3: FL (Anti-dumping) Mode: During the use, the dumping angle of the product is greater than 10° will activate the Anti-dumping Mode. The LED will keeps flickering.

Button	Graphic	Feature
Up Arrow		Up one heating level
Max		The heater goes directly to the highest heating level
Down Arrow		Down one heating level
Timing Key -		1-24h setting, press once to reduce 1 hour, display the remaining time on the screen, and press for a long time to enter the setting mode.
Timing Key +		1-24h setting, press once to increase 1 hour, display the remaining time on the screen, and press for a long time to enter the setting mode.
On		To switch the heater on: Press ON. The patio heater has a soft start function of 50% power, 4 seconds after the heater has been turned on, it will automatically switch to the last heating level used. In case of the first-time use, after 4 seconds the heater will automatically switch to 100% power.
Off		To switch the heater off: Press OFF. The heater will switch to standby mode (the receiver indicator will light up).

REMOTE CONTROL GUIDE

1. Remote control distance works up to 3-4 m.
2. For optimal usage, align the remote to the receiver as illustrated here.



Max. remote distance: 5 M

NOTICE

- The remote control works with 2 AAA 1.5V batteries (sold separately). If the appliance will not be in use, remove the batteries from the remote to minimize any risk of damage.
- Ensure only the approved battery sizes is used for the remote. Misuse may result in damage to the remote or unit's function.
- Contact a service technician for additional assistance if needed.
- Remote may not work if there is a physical blockage interfering between the appliance and remote.
- Replace all batteries as needed to ensure proper function of appliance and remote.

1

OPERATION INSTRUCTION

Inspect all components, including the main unit, supply cord, and plugs, for any signs of damage. Take off all screws.

If any parts or hardware pieces are missing or damaged, please contact customer service at support@eastoak.com. In your email, include your shipping address and product information. We will send you replacement parts for free.

Place the product vertically on the ground and connect the plug to the socket. Turn on the switch and connect the power, to check if the heater can work well.

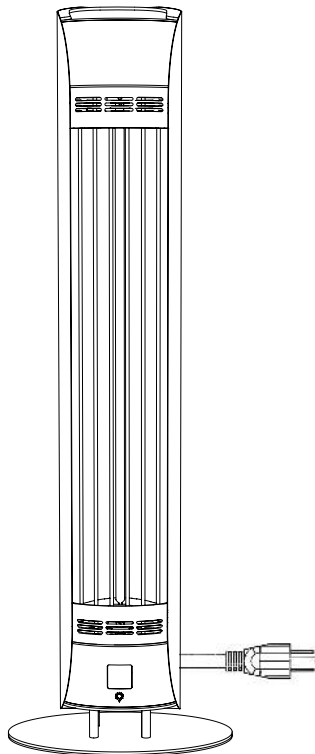

2

- Don't move or cover the heater while it is working.
- Plug in the power source and operate the remote control. Then observe, whether during the first 10-15 minutes the appliance works trouble-free.
- If you do not use, please remove the battery socket.

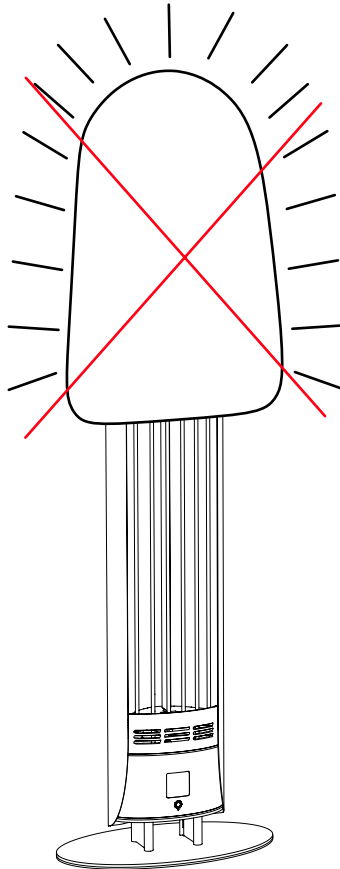

GROUNDING INSTRUCTIONS

This heater is compatible with 120-volt sockets. The plug (A) is shown Figure 60.1. An adapter (C) is available to adapt three-blade plugs to two-slot sockets. The green grounding extension must be connected to a permanent ground, such as an outlet box. The adapter should not be used if a three-slot socket is available.

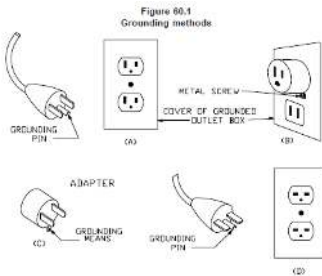

SERVICE

- For your safety, all repairs must be done by an authorized and trained electrician only.
- Please contact the manufacturer or an electrician for your choice.
- Unauthorized repairs may lead to property damage, injury, or death.
- Unauthorized repairs may lead to property damage, injury, or death.
- Our warranty does not cover any damage resulting from unauthorized repairs, accidents, misuse, or maintenance abuse.
- We are committed to continuous product development and we reserve the right to change the product and documentation specifications without notice.
- For any services, please contact customer service at support@eastoak.com.

WARRANTY

GUARANTEED 3-YEAR WARRANTY

Thank you for choosing East Oak. This product is covered by our company warranty for up to 3 years from its original purchase date.

CLAIM WARRANTY

To claim your product's warranty, register your new product on our website at www.eastoak.com/warranty.

The first part of the document discusses the importance of maintaining accurate records in a business setting. It highlights how proper record-keeping can help in identifying trends, making informed decisions, and ensuring compliance with legal requirements. The text emphasizes that records should be organized, up-to-date, and easily accessible to relevant personnel.

Next, the document addresses the challenges associated with data management in the digital age. It notes that while digital storage offers convenience and scalability, it also introduces risks such as data loss, security breaches, and information overload. To mitigate these risks, the document suggests implementing robust backup strategies, strong security protocols, and regular data audits.

The third section focuses on the role of technology in enhancing record management. It explores various software solutions and tools that can streamline the process of creating, storing, and retrieving records. The text mentions that cloud-based systems offer the advantage of remote access and collaboration, but also caution against over-reliance on technology without proper training and oversight.

Finally, the document concludes by stressing the importance of a clear policy and procedure for record management. It advises that all employees should be trained on the correct ways to handle records, and that there should be a designated person or team responsible for overseeing the record-keeping process. Regular reviews and updates to the policy are also recommended to keep it relevant and effective.

EAST OAK

✉ support@eastoak.com

🌐 eastoak.com

☎ 1-833-EAST-OAK (USA)