

Eventide®

H90

Harmonizer®



USER GUIDE

Copyright 2024, Eventide Inc
P/N: #141385
Version 1.9.7

Bluetooth® and the Bluetooth logo are registered trademarks of Bluetooth SIG, Inc.
Eventide is a registered trademark of Eventide Inc.
Harmonizer is Eventide's trademark for a special effects device that incorporates pitch change.
MixingLink® is a registered trademark of Manifold Labs, LLC.
All other trademarks contained herein are the property of their respective owners.

Eventide Inc.
One Alsan Way
Little Ferry, NJ 07643
United States of America
201-641-1200

www.eventideaudio.com

Table Of Contents

1. Introduction

1.1. Key Features	13
1.2. A Few Words of Advice	14
1.3. What's in the Box	14

2. Hardware

2.1. Top Panel	15
2.2. Rear and Side	18

3. Setup

3.1. Simple Guitar Setup	21
3.2. Two Mono Inserts	23
3.3. One Stereo Insert	24
3.4. Wet/Dry Amplifier	26
3.4.1. Wet/Dry Examples	28
3.5. Wet/Dry/Wet Amplifier	29
3.6. Guitar and Vocals with MixingLink	29
3.7. Pre/Post Amplifier	30
3.8. Dual Inserts with a DAW or Mixing Console	32

4. Terminology

4.1. List	35
4.2. Program	35
4.3. Algorithm	36
4.4. Preset	36

5. Play Modes

5.1. Select Mode	39
5.1.1. Program Select	39
5.1.2. Bank Select	40
5.2. Perform Mode	40
5.2.1. Performance Parameters	41
5.3. Quick Knob Assignments	44

6. Edit Modes

6.1. Programs	47
6.1.1. Saving Programs	48
6.2. Routing	49
6.2.1. Insert Routing	50
6.2.2. Dual Routing	55
6.3. Presets	57
6.3.1. Saving Presets	58
6.4. Parameters	59
6.4.1. Mapping	61
6.4.2. HotKnob	62
6.4.3. HotSwitch	63
6.4.4. Tempo Sync	64

7. System Menu

7.1. Global	65
7.2. I/O	69
7.3. Bluetooth	72
7.3.1. macOS connection:	75
7.3.2. iPad Connection	79
7.3.3. iOS Connection	85
7.3.4. Pairing your H90 to multiple devices	93
7.3.5. Bluetooth System Requirements	93
7.4. MIDI	93
7.5. Preferences	96
7.6. About	97

8. Tempo Menu

9. Software Updates

10. H90 Control

10.1. Getting Started	103
10.1.1. Register and Install	103
10.1.2. Connection	104
10.2. Home Screen	104
10.3. Edit Menu	106
10.3.1. The Playlist	107
10.3.2. Parameters Edit Menu	109
10.3.3. Routing/Inserts	113
10.3.4. Control Assignments	114
10.3.5. Preset Library	115
10.4. Program Library	116
10.5. System	118
10.6. Using dot9 Stompboxes	121
10.6.1. dot9 Edit Menu	122
10.6.2. dot9 System Settings	124

11. Algorithm Guide

Delay	127
Band Delay	128
Bouquet Delay	129
Digital Delay	130
Ducked Delay	132
Filter Pong	133
Head Space	135
Mod Delay	137
MultiTap	138
Reverse	140
Tape Echo	141
UltraTap	143
Vintage Delay	145
Distortion	146
Aggravate	147
CrushStation	148
PitchFuzz	149
Sculpt	150
WeedWacker	151
EQ	152
EQ Compressor	153
Looper	154

Modulation	163
Chorus	164
Even-Vibe	166
Flanger	167
Harmadillo	168
Instant Flanger	172
Instant Phaser	174
ModFilter	176
Phaser	178
Q-Wah	180
RingMod	183
Rotary	184
Sticky Tape	186
TremoloPan	187
Tricerachorus	189
Undulator	192
Vibrato	194
Multi	196
SpaceTime	197
Pitch	198
Crystals	199
Diatonic	200
H910 H949	201
HarModulator	203
HarPeggiator	205

MicroPitch	212
Octaver	213
PitchFlex	214
PolyFlex	215
Polyphony	216
Prism Shift	218
Quadravox	220
Resonator	221
Reverb	222
Blackhole	223
DualVerb	224
DynaVerb	225
Hall	226
MangledVerb	227
ModEchoVerb	228
Plate	229
Reverse Reverb	230
Room	231
SP2016 Reverb	231
Spring	233
Shimmer	234
TremoloVerb	235
Wormhole	237
Synth	238
HotSawz	239

PolySynth	241
Synthonizer	243
Utility	244
Mute	245
Thru	245

A. Tech Support

B. Tech Specs

C. Global Mapping Chart

D. Startup Sequences

D.1. Recovery Mode	257
D.2. Clear Current State	257
D.3. Factory Reset	258

E. Legalese

5.1. Safety and Warranty	259
5.2. FCC Compliance Statement	262

This page was intentionally left 99.88% blank.

1. INTRODUCTION

Congratulations on choosing the Eventide H90 Harmonizer, our next-generation multi-effects pedal. Our live-performance audio processors put the power of our rack mount effects into the hands and at the feet of performing musicians. Whether you want high-quality effects or experimental sounds yet unheard, the H90 offers the great sounding effects you have always loved from Eventide, and more. Complete with an intuitive UI, comprehensive I/O, flexible routing options, and a wealth of effects to choose from, the H90 is designed to be the heart of your rig.

1.1. Key Features

- Preloaded with 66 effect algorithms:
 - 14 new effect algorithms:
 - Aggravate
 - Bouquet Delay
 - Even-Vibe
 - Head Space
 - Instant Flanger
 - Instant Phaser
 - PolyFlex
 - Polyphony
 - PolySynth
 - Prism Shift
 - SP2016 Reverb
 - Sticky Tape
 - WeedWacker
 - Wormhole
 - Includes all 52 effect algorithms from the H9 Max Harmonizer with enhanced features and improvements
- New low-latency Polyphonic Pitch Shifting with SIFT (Spectral Instantaneous Frequency Tracking) technology
- ARM-based architecture lays the foundation for new and exciting creative effects
- Use two algorithms at once per Program
- True spillover between Programs
- Route effects in series or parallel
- Instrument or Line level operation

- Two mono inserts or one stereo insert can be positioned anywhere in the signal chain
- Dual Routing for processing two independent stereo signals at once
- Five push-turn encoders for more tactile control
- Two expression inputs for pedals, up to three-button auxiliary switches, and CV signals
- Use H90 Control software to edit Programs, create lists, and update firmware on a Mac or PC
- Built-in instrument tuner

1.2. A Few Words of Advice

The H90 packs an impressive amount of processing and flexibility into a compact package. To get a full understanding of what the H90 offers, we recommend taking the time to explore this User Guide. However, if you're eager to get going, at least read the included Quick Reference Guide or view the Setup Chapter (Section 3) to help you get started.

1.3. What's in the Box

The box contains:

- H90
- Quick Reference Guide
- Universal AC power supply
- USB-C to USB-A cable
- 4x rubber feet
- Eventide sticker
- Guitar pick

2. HARDWARE

Before you set up your H90, let's get familiar with the main controls and input and output connections.

2.1. Top Panel

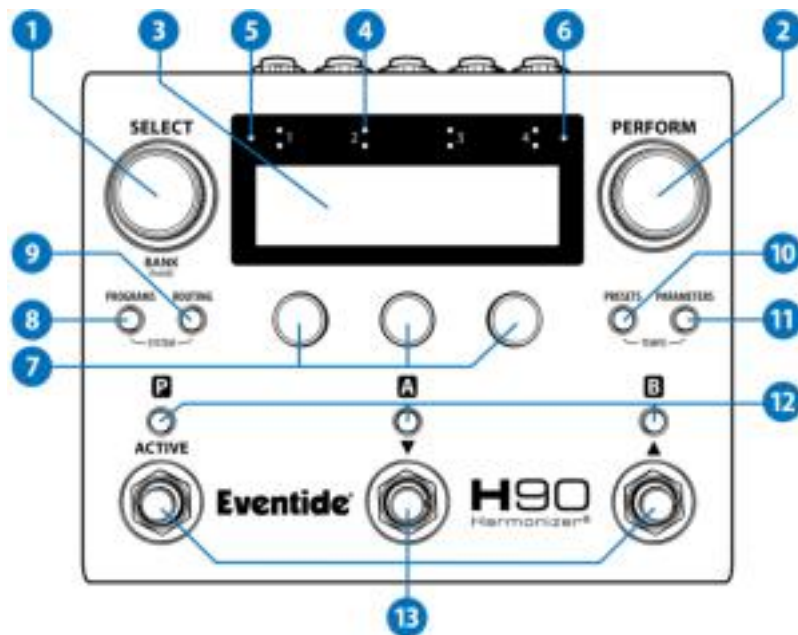

Fig. 2.1 H90 Top Panel

1. SELECT Knob

Press the Select Knob to enter Select Mode. Press and hold the Select Knob to enter Bank Select Mode.

2. PERFORM Knob

Press the Perform Knob to enter Perform Mode. Turn the Perform Knob to adjust the Program HotKnob (Section 6.4.2)

3. OLED Display

Displays user interface with access to Effect Parameters and System Settings.

4. Input Level Indicators

The bottom row of LEDs indicate signal presence for input channels 1-4. The top row indicates clipping. If your signal is overloading the H90's inputs, adjust the output level of your device or adjust the H90's input levels.

5. Bluetooth On/Off

This LED indicates the H90's Bluetooth active status.

6. Bluetooth Connection

This LED indicates if the H90 is paired with another device via Bluetooth.

7. Quick Knobs

Use the three Quick Knobs to adjust parameters and settings.

8. Programs

Press to enter Programs Edit Mode to browse and audition Programs.

9. Routing

Press to enter Routing Edit Mode. Press again to cycle through Insert parameters.

Tip

Press and hold the Programs and Routing Buttons simultaneously to access the System Menu.

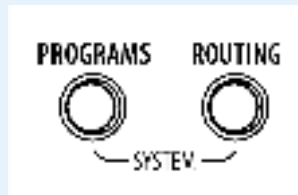

Fig. 2.2 Press and hold the Programs and Routing Buttons simultaneously

10. Presets

Press to enter Preset Edit Mode and browse the Preset Library.

11. Parameters

Press to enter Parameters Edit Mode to adjust Program and Preset parameters.

Tip

Press and hold the Presets and Parameters Buttons simultaneously to access the Tempo Menu.

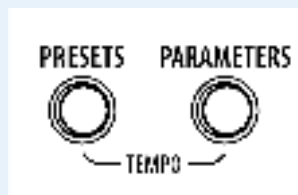

Fig. 2.3 Press and hold the Presets and Parameters Buttons simultaneously

12. P/A/B LED Buttons

In Select/Bank mode, press the LED Buttons to activate/bypass a Program or Preset. In Perform mode, press the LED Buttons to assign a Performance Parameter to a Footswitch.

13. Footswitches

In Select/Bank Mode, use the three Footswitches to cue up and load Programs. In Perform Mode, these are user-programable Footswitches.

2.2. Rear and Side

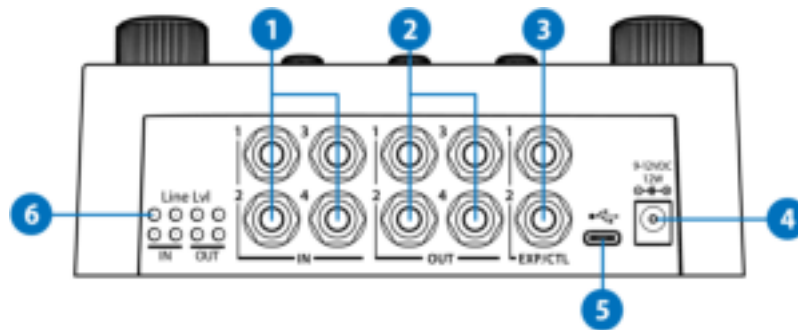

Fig. 2.4 H90 Rear

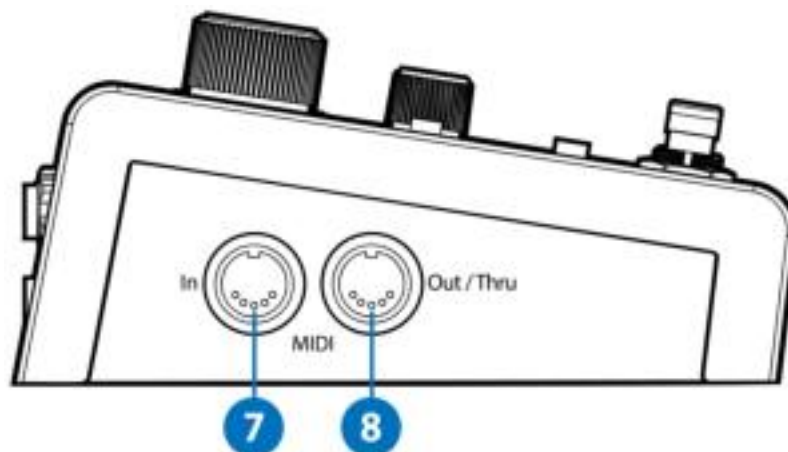

Fig. 2.5 H90 Side

1. Analog Inputs

Four ¼" mono tip/sleeve input jacks. Configurable to instrument or line level.

2. Analog Outputs

Four ¼" mono tip/sleeve output jacks. Configurable to instrument or line level.

Tip

If you're not sure how to connect the H90's inputs and outputs, visit Setup (Section 3) for information about how to integrate the H90 into your rig.

3. EXP/CTL

Two ¼" tip/ring/sleeve input jacks for a variety of parameter mapping and assignment options. Accepts the following:

- 10-25 K expression pedals.
- 1-3 button auxiliary switches. Use momentary normally open switches.
- 0-5 V control voltages. Voltage source should be on the tip of the connected cable.

4. Power Input

Use the supplied 12V 1A power adapter to power your H90. Center positive (+), 5.5/2.5mm jack

5. USB-C

Connect to your computer for updates and Program and Preset management via the H90 Control app. Also used to receive MIDI over USB.

Warning

We recommend only using the included USB cable, or USB cables that are compliant with the USB-C specification; using non-compliant cables can cause serious performance issues or damage your device.

Line Level LEDs

6.

These LEDs indicate which inputs and outputs are set to line level.

7. MIDI DIN In

Connect MIDI devices to control the H90's parameters, select Programs via PC messages, and sync to external MIDI clock sources.

8. MIDI DIN Out/Thru

Sync MIDI devices to the H90's internal clock, or transmit PC messages and H90 controllers as CCs.

3. SETUP

Get in tune!

Press and hold the A and B Footswitches together to access the tuner.

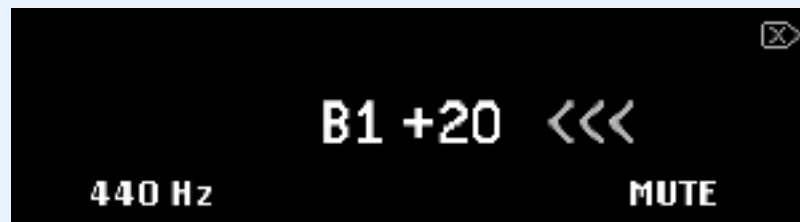

Fig. 3.1 Tuner display page

- Turn Quick Knob 1 to change the tuning frequency in one-Hz increments.
- Turn Quick Knob 3 to change from Mute to Thru.
- Note that the tuner is accessible in every Mode except Perform Mode.

3.1. Simple Guitar Setup

It's best to start simple.

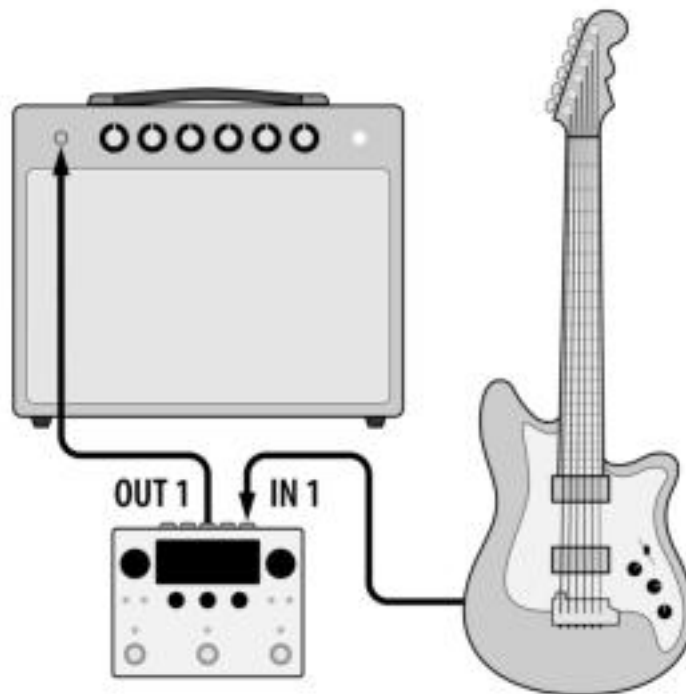

Fig. 3.2 A simple mono guitar configuration

- Connect your guitar to H90 Input 1.
- Connect H90 Output 1 to your guitar amp.
- Use Select Mode to explore the User 1 Playlist.

! Auditioning Programs

A selection of Programs have been curated from the Factory Lists and added to the User 1 List. To explore this curated List, press the Select knob to enter Select Mode (Section 5.1). To search through all the Programs on the H90, press the Programs Button to enter Programs Edit Mode (Section 6.1).

3.2. Two Mono Inserts

This configuration introduces two mono inserts. In this example an [Eventide dot9 MicroPitch](#) stompbox is being used for Insert 1, and an [Eventide H9 Max](#) is being used for Insert 2.

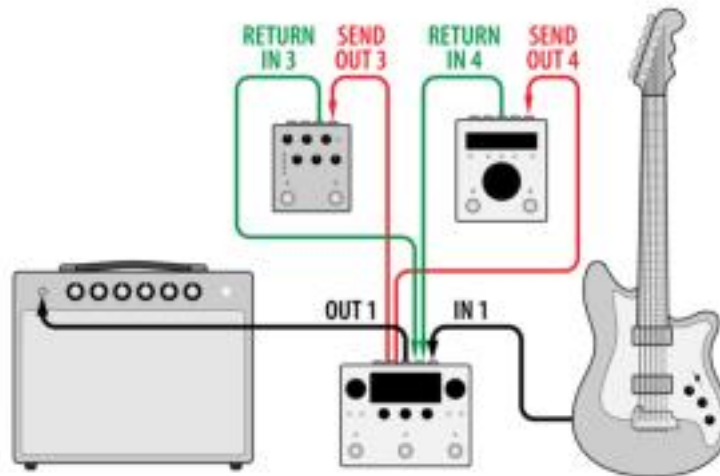

Fig. 3.3 Two Mono Inserts

- Connect your guitar to H90 Input 1.
- Connect H90 Output 1 to your guitar amp.
- Connect H90 Output 3 to MicroPitch Input.
- Connect MicroPitch Output to H90 Input 3.
- Connect H90 Output 4 to H9 Max Input.
- Connect H9 Max Output to H90 Input 4.

- Press the Routing Button and turn the Quick Knobs to select where the Inserts will be in the signal path.
- Check out Insert Routing (Section 6.2.1) for more info.

3.3. One Stereo Insert

You can also use a single stereo insert, such as an [Eventide PitchFactor](#).

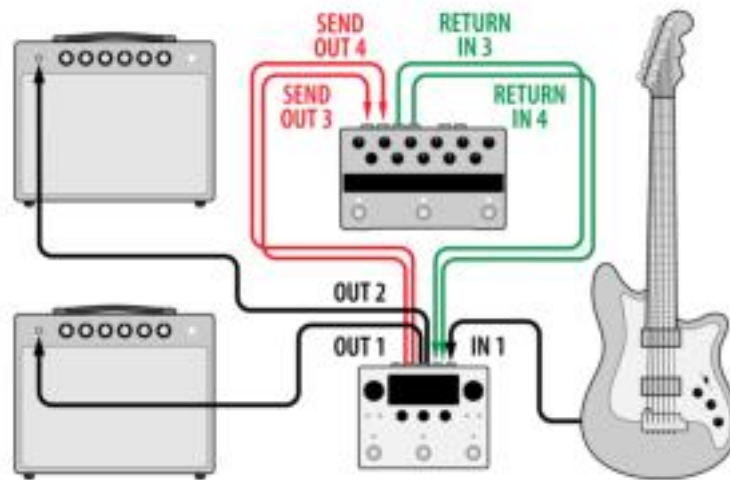

Fig. 3.4 One Stereo Insert

- Connect your guitar to H90 Input 1.
- Connect H90 Output 1 to guitar amp 1.
- Connect H90 Output 2 to guitar amp 2.
- Connect H90 Output 3 and 4 to PitchFactor Inputs.
- Connect PitchFactor Outputs to H90 Inputs 3 and 4.
- Press the Routing Button and turn Quick Knob 3 all the way clockwise to enable the Stereo Insert. Turn Quick Knob 2 to select where the Stereo Insert will be in the signal path.

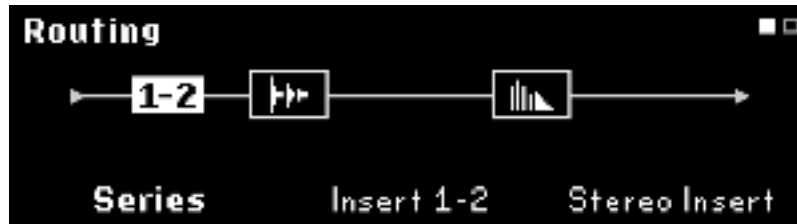

Fig. 3.5 Stereo Insert pre-Preset A and B

- Check out Insert Routing (Section 6.2.1) for more info.

Tip

If any of your connected gear operates at line level instead of instrument level, press and hold the Programs and Routing Buttons together to access the System Menu, navigate to the I/O menu, and set the levels appropriately.

3.4. Wet/Dry Amplifier

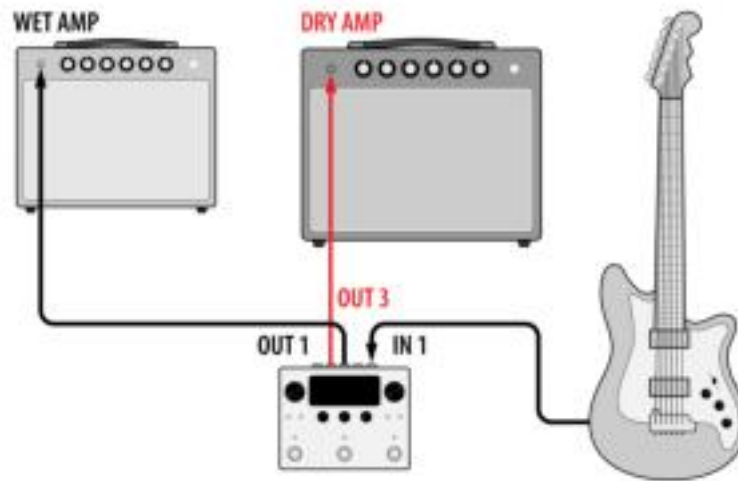

Fig. 3.6 **Wet/Dry guitar amp configuration**

A wet/dry amplifier setup allows you to use two amplifiers and place different types of effects in each amplifier. Typically, the “dry” amplifier would be used for distortion, EQ, and compression effects, while the “wet” amplifier would be used for time-based effects, such as modulation, delay, and reverb.

- Connect your guitar into H90 Input 1.
- Connect H90 Output 1 into the “wet” amplifier’s input.
- Connect H90 Output 3 into the “dry” amplifier’s input.
- Press the Routing Button and turn Quick Knob 2 to determine where you’d like to tap your signal to be sent to the dry amplifier.
- Depending on your Preset routing and the tap position of your dry amp, you’ll need to adjust the Insert Mix parameter accordingly. See examples below.
- Use the Send Level parameter of Insert 1 to adjust the gain of the signal being sent to the dry amplifier.
- Turn Kill Dry on for whichever Presets are being used with the wet amplifier.
- Set Program Bypass Mode to “AB Only”. This will make it so the insert paths are not muted when the Program is bypassed.

3.4.1. Wet/Dry Examples

Series

Using Series routing, if the tap position of the dry amp is pre-Preset A and B, this gives you an unprocessed signal in the dry amp, and a signal that is processed by both Presets in the wet amp.

Set the Insert Mix to 0% and try using a combination of modulation and reverb in the wet amp, such as Even-Vibe in series with SP2016 Reverb.

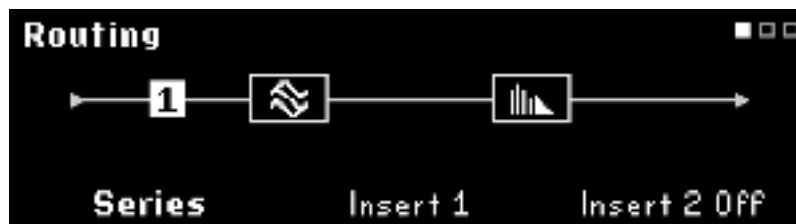

Fig. 3.7 The tap position of the dry amp is pre-Preset A in Series

Parallel

Using Parallel routing, if the tap position of the dry amp is post-Preset A, this allows you to process the signal sent to your dry amp with Preset A, while Preset B is sent to the wet amp in a parallel path.

Set the Insert Mix to 100% and try using WeedWacker in Preset A for the dry amp, and Head Space in Preset B for the wet amp. Since you are using a parallel path, WeedWacker will only process the audio going into the dry amp, while your guitar's clean signal will be processed by Head Space and sent the wet amp.

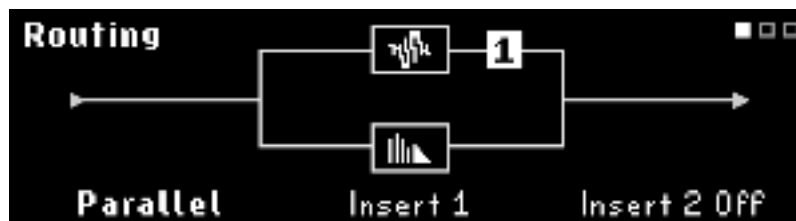

Fig. 3.8 The tap position of the dry amp is post-Preset A in Parallel

3.5. Wet/Dry/Wet Amplifier

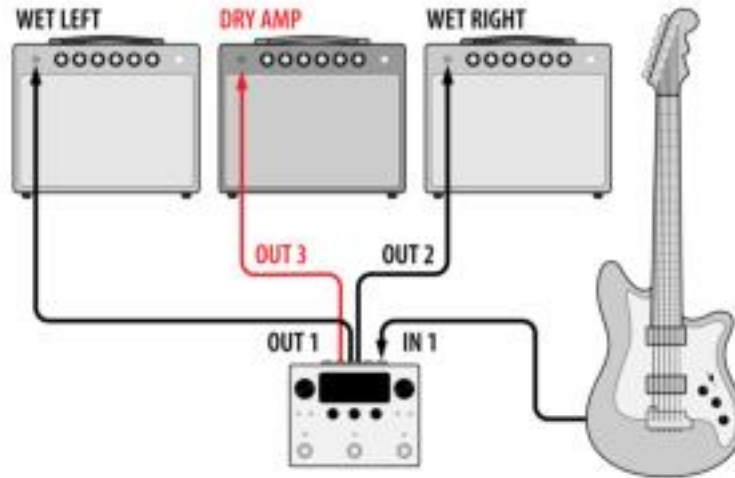

Fig. 3.9 **Wet/Dry/Wet** guitar amp configuration

A wet/dry/wet amplifier setup is similar to the Wet/Dry Amplifier setup, but this adds another amplifier to the “wet” portion of the rig, allowing you to create a true stereo image and hear all of the glory of the H90’s stereo effects processing.

- Connect your guitar into H90 Input 1.
- Connect H90 Output 1 into the left “wet” amplifier’s input.
- Connect H90 Output 2 into the right “wet” amplifier’s input.
- Connect H90 Output 3 into the “dry” amplifier’s input.
- Press the Routing Button and turn Quick Knob 2 to determine where you’d like to tap your signal to be sent to the dry amplifier.
- Depending on your Preset routing and the tap position of your dry amp, you’ll need to adjust the Insert Mix parameter accordingly. See Wet/Dry Examples for more details.
- Use the Send Level parameter of Insert 1 to adjust the gain of the signal being sent to the dry amplifier.
- Turn Kill Dry on for whichever Presets are being used with the wet amplifier.
- Set Program Bypass Mode to “AB Only”. This will make it so the insert paths are not muted when the Program is bypassed.

3.6. Guitar and Vocals with MixingLink

Using the [Eventide MixingLink](#), you can easily amplify a microphone signal, as well as another signal such as guitar, on two separate effects paths using the H90's Dual Routing feature.

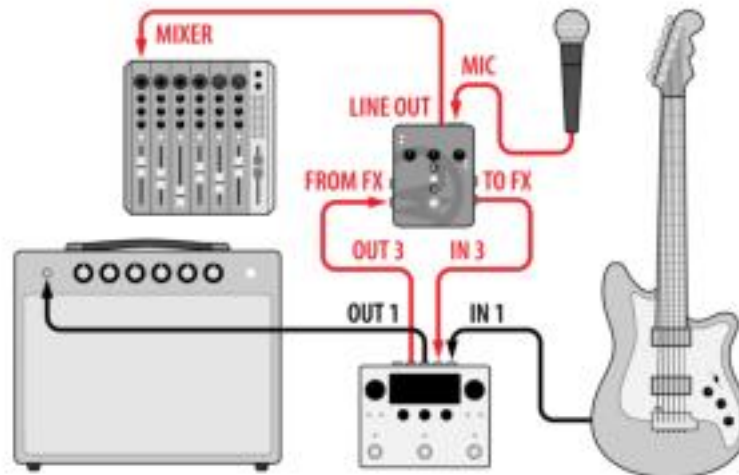

Fig. 3.10 Guitar and Vocals with MixingLink

- Configure your H90's Global Routing Configuration (Section 7.1) to use Dual Routing from the System Menu.
- Connect your guitar to H90 Input 1.
- Connect H90 Output 1 to your guitar amp.
- Connect your microphone to the MixingLink mic input.
- Connect MixingLink Line Output to a monitor input, such as a mixing console.
- Connect MixingLink 'To FX' Output to H90 Input 3.
- Connect H90 Output 3 to MixingLink 'From FX' Input.
- Press the Routing Button and turn Quick Knob 1 to adjust the routing position to Pre/Post. This enables Preset A to be on Path 1 and Preset B to be on Path 2. Now we can use Preset A to process our guitar signal into the guitar amp, and Preset B to process the microphone signal into a different input source.
- Check out Dual Routing (Section 6.2.2) for more info.

3.7. Pre/Post Amplifier

If your guitar amp has an effects loop, it is sometimes desirable to put certain effects such as drive or compression before the preamp, and other effects such as delay and reverb after the preamp. This can be referred to as a Pre/Post setup, or the four-cable method (4CM).

Dual Routing allows you to setup a variety of Programs that use different routing configurations with your favorite effects at different positions of your amp's signal path.

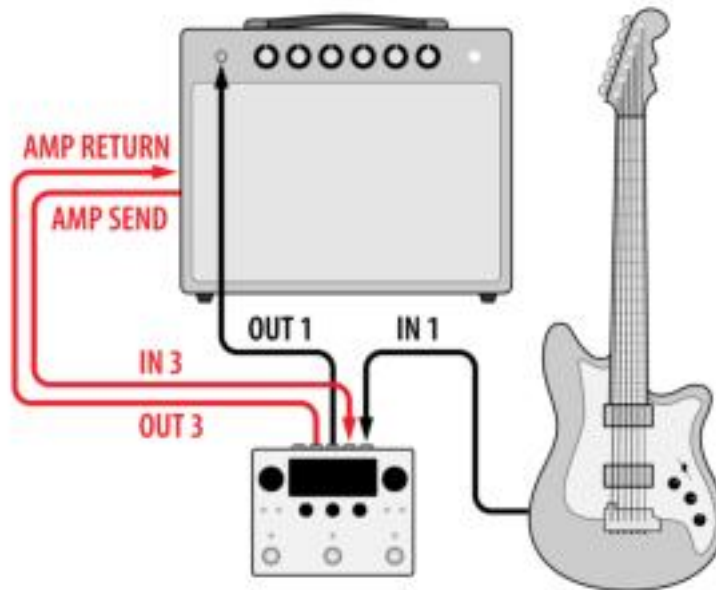

Fig. 3.11 A Pre-post or 4-cable method guitar amp configuration

- Configure your H90's Global Routing Configuration (Section 7.1) to use Dual Routing from the System Menu.
- Connect your guitar to H90 Input 1.
- Connect H90 Output 1 to your guitar amp's preamp input.
- Connect your guitar amp's effects send to H90 Input 3.
- Connect H90 Output 3 to your guitar amp's effects return.
- Press the Routing Button and turn Quick Knob 1 to adjust the routing position to Pre/Post. This will place Preset A between your guitar and preamp on Path 1, while Preset B will be placed in the amp's effects loop on Path 2.

- Turn Kill Dry on for whichever presets are in the amp's effects loop.
- Check out Dual Routing (Section 6.2.2) for more info.

3.8. Dual Inserts with a DAW or Mixing Console

The H90 is well suited to be used as an outboard effects processor for a mixing console or your DAW. Using Dual Routing allows you to use the H90 as two separate signal processing paths, so Path 1 can be your reverb bus, and Path 2 can be your delay bus.

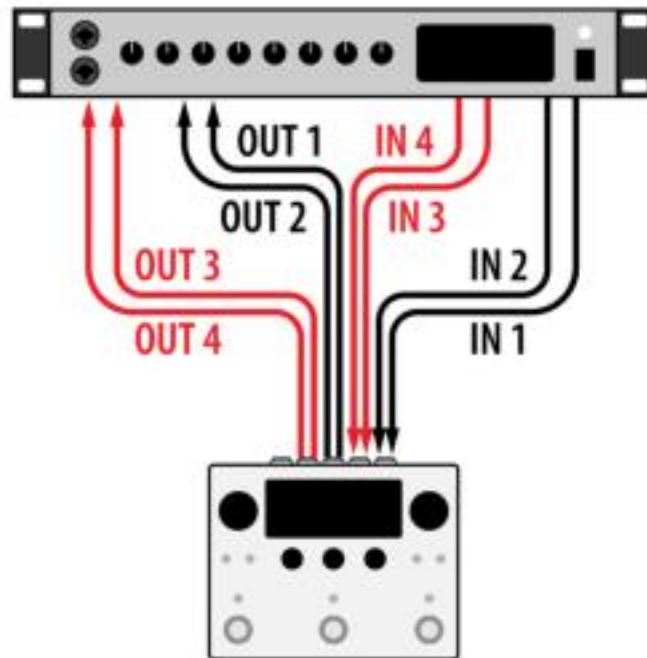

Fig. 3.12 Dual Inserts are connected to an audio interface

- Configure your H90's Global Routing Configuration (Section 7.1) to use Dual Routing from the System Menu.
- Connect a stereo pair of Outputs from your mixing console or audio interface to H90 Input 1 and 2.

- Connect H90 Output 1 and 2 to aux return 1 of your mixing console or to a pair of Inputs on your audio interface.
- Connect another stereo pair of Outputs from your mixing console or audio interface to H90 Input 3 and 4.
- Connect H90 Output 3 and 4 to aux return 2 of your mixing console or to a pair of Inputs on your audio interface.
- Press the Routing Button and turn Quick Knob 1 to adjust the routing position to Pre/Post. When you send audio to aux channel 1 of your mixer, it will be processed by Preset A on Path 1. Audio that is sent to aux channel 2 of your mixer will be processed by Preset B on Path 2.
- Consult the documentation for your DAW or audio interface for additional instructions to send audio to and from them.
- Check out Dual Routing (Section 6.2.2) for more info.

Tip

If you'd like the H90's tempo to sync to an external MIDI device via DIN or USB, navigate to the Tempo Menu (Section 8) and set the Tempo Source appropriately.

This page was intentionally left 99.88% blank.

4. TERMINOLOGY

These terms represent the overarching layout of the H90:

4.1. List

Lists contain up to 99 Programs each, and are divided into editable User Lists and un-editable Factory Lists. The H90 ships with an assortment of Factory Lists, from which a choice selection of Programs have been picked for the first User List. The currently active List is referred to as your Playlist.

Select Mode allows you to select Programs from your Playlist, while Programs Edit Mode allows you to search through both Factory Lists and User Lists.



Fig. 4.1 Programs Edit Mode with the List filter set to All

4.2. Program

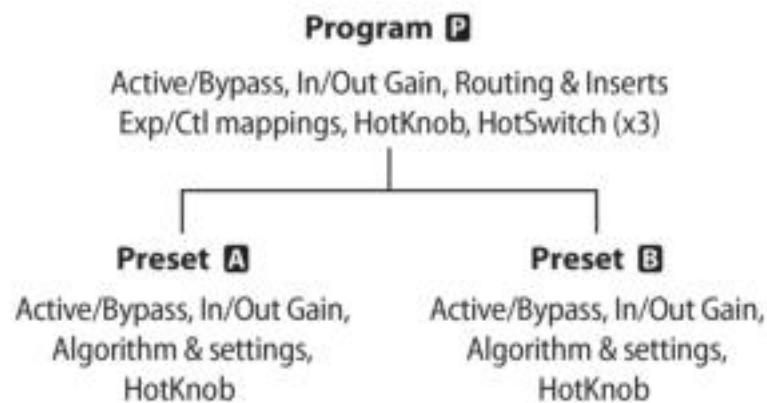

Fig. 4.2 Anatomy of a Program

A Program is the primary multi-effect component of the H90. The H90 runs one Program at a time, and each Program runs any two of the available Algorithms, each of which can be routed in a variety of ways. Switching between Programs is instantaneous, and features spillover, which allows the previous Program's reverb/delay tail to decay naturally when another Program is loaded.



Fig. 4.3 Program Select Mode displaying the Clean Ambient Program

4.3. Algorithm

An Algorithm is an Eventide-designed audio processing module, with carefully chosen parameters. Each parameter may be adjusted and mapped (Section 6.4) to Footswitches, knobs, expression pedals, and MIDI. The Algorithm Guide provides in-depth descriptions of each Algorithm.

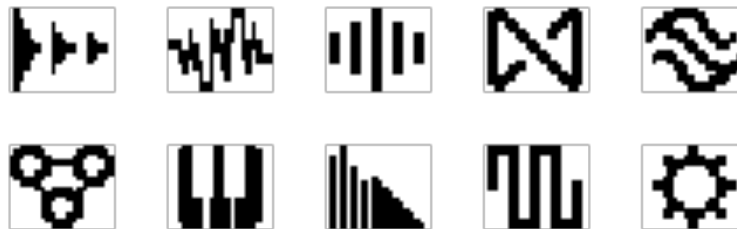

Fig. 4.4 Algorithms are categorized by Effect Type. Each Effect Type has a signature icon.

4.4. Preset

A Preset is an Algorithm with a unique combination of parameter values that can be saved to the Preset Library, or within a Program.



Fig. 4.5 The Polyphony Algorithm's Preset, Jazz Vibes, in Parameters Edit Mode

This page was intentionally left 99.88% blank.

5. PLAY MODES

The H90 has two Play Modes: Select and Perform. Picking one of these two Play Modes will determine how you interface with the pedal.

In Select Mode, using Program Select allows you to scroll through the entire Playlist, while Bank Select organizes your Playlist into Banks of three Programs, giving you quick access to instantly load any three programs using the Footswitches.

Perform Mode lets you customize how you interact with your Programs, allowing for a variety of Footswitch and HotSwitch mappings for any situation.

Whether you are loading Programs for each song in a gig, or engaging the perfect effect for that special moment during your guitar solo, the Play Modes allow you to easily navigate and control your H90.

5.1. Select Mode

To enter Select Mode, press the Select Knob.

Select Mode allows you to queue up and load Programs from your Playlist, which is configured in the System Menu's Global page. Select Mode has two views: Program Select, and Bank Select. Press and hold the Select Knob to toggle between the two.

5.1.1. Program Select

Program Select Mode displays one Program at a time. The Program's two Algorithm and Preset names will be displayed while scrolling through the Playlist.



Fig. 5.1 Program Select display

Turn the Select Knob or press the A or B Footswitch to scroll up and down through the Playlist.

Press the P (Active) Footswitch, or the Select Knob, to load the highlighted Program. The Active LED and the Program Number will blink until the selection is confirmed. The highlight will revert after a few seconds if the Active Footswitch or the Select Knob are not pressed.

5.1.2. Bank Select

Bank Select Mode displays three Programs at a time by dividing the Playlist of 99 Programs into 33 banks of three Programs each.



Fig. 5.2 Bank Select display

Turn the Select Knob, or press and hold the A or B Footswitch to scroll through the banks.

Press any Footswitch to load one of the three Programs in the selected bank. The LED above that Footswitch will illuminate to indicate that the Program is active.

Press the same Footswitch again to bypass the Program.

Press and hold the P Footswitch to go to Bank 1.

You can also configure an aux switch or MIDI controller to perform the Bank Up or Down functions using the Global Control settings (Section C). This allows you to use the P/A/B Footswitches for activating your Programs, while an additional controller scrolls through the Program banks.

5.2. Perform Mode

To enter Perform Mode, press the Perform Knob.

Perform Mode allows you to customize the H90's interface with two pages of user-programmable Footswitch assignments such as tap tempo, active/bypass, momentary active, three independent HotSwitches, and Algorithm-specific parameters.

The H90's algorithm-specific performance parameters can provide for a wealth of expressive and artistic tools, right at your feet!

- Wormhole's Warp parameter takes you on a light speed journey through the Universe.
- Bouquet Delay's Pitch Jump allows you to bounce between precise musical intervals with an analog flavor.
- Prism Shift lets your Freeze your signal, or momentarily change your pitch-shifted intervals.
- Head Space allows you to Boil or Break your tape echo and create unheard-of sounds.

Furthermore, the three onboard HotSwitches allow you to map a range of parameters within a Program, it's like getting three additional Programs for the price of one!

5.2.1. Performance Parameters

In Perform Mode, the P Footswitch is mapped to the Program's performance parameters, and the A and B Footswitches are mapped to their respective Presets' performance parameters.

Press the Perform Knob to toggle between two pages of performance parameter Footswitch assignments.



Fig. 5.3 Perform Mode displaying the first page of the performance parameter assignments

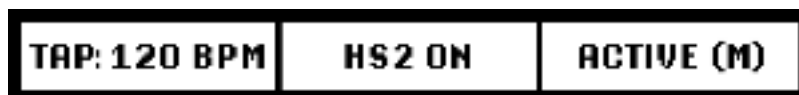

Fig. 5.4 Page one of performance parameter assignments



Fig. 5.5 Page two of the performance parameter mappings

5.2.1.1. Assign to Footswitches

Press the P, A, or B LED Button to cycle through a List of the P, A, or B Footswitch available performance parameters. The available performance parameters will vary depending on what Presets are currently loaded, there are choices like momentary states denoted by the (M), or a HotSwitch, or the performance functions of the algorithm.

Each Footswitch's LED will change color depending on what parameter is assigned. Note that the colors play a role in these assignments:

- A White LED indicates active states, or even Insert active states.
- An Aqua color indicates a HotSwitch.
- Blue indicates a delay parameter, such as Tap Tempo, repeat or feedback oscillation.
- Red indicates a pitch shifting parameter, such as the Flex parameter for PitchFlex.
- Green indicates a modulation parameter, such as an LFO Brake/Speed or Retrigger.

Performance Parameter Assignment Options		
P Footswitch	A Footswitch	B Footswitch
Program Active/ Bypass	Preset A Active/Bypass	Preset B Active/Bypass
Program Active/ Bypass (M)	Preset A Active/Bypass (M)	Preset B Active/Bypass (M)
Ins 1 Active/Bypass	HS2 On/Off	HS3 On/Off
Ins 2 Active/Bypass	HS2 On/Off (M)	HS3 On/Off (M)
HS1 On/Off	Preset A Tap Tempo	Preset B Tap Tempo
HS1 On/Off (M)	Preset A Algorithm Specific Parameters	Preset B Algorithm Specific Parameters

Performance Parameter Assignment Options

Program Tap Tempo

5.2.1.2. Map to External Controllers

You may find that you'll want more than just six footswitches to control the variety of performance parameters offered by a given Program. For instance, you may want to always control the bypass/active states of your Programs and Presets using the H90's footswitches and control the HotSwitches and algorithm-specific performance parameters from another source. This can be accomplished by mapping these parameters to an external controller.

- Press and hold the P, A, or B LED Button to begin mapping the P, A, or B performance parameters to an external auxiliary switch or a MIDI CC message.
- Turn Quick Knob 1 to select a parameter.
- Turn Quick Knob 2 to select a control source for that parameter.
- These maps will be active in Select Mode as well.

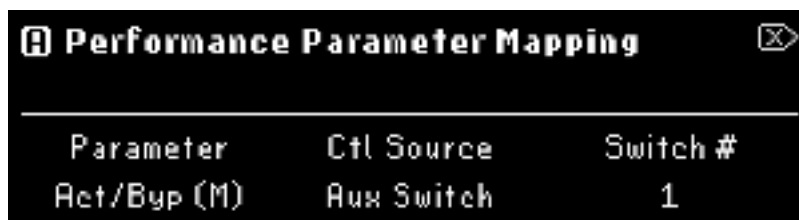

Parameter	Ctl Source	Switch #
Act/Byp (M)	Aux Switch	1

Fig. 5.6 Performance Parameter mapping menu

Note

In order to use all of the H90's latching/momentary/trigger footswitch functions, you must use either momentary normally open aux switches, or momentary MIDI CC footswitches that are 64 or higher when pressed, and 63 or below when released.

5.2.1.3. Tap Tempo

Tap Tempo on the H90 can work in two ways:

- **Tempo Sync:** Press the Presets and Parameters buttons simultaneously to enable Tempo Sync for a Preset. The Preset's time based parameters, such as an LFO or delay time, will be displayed as rhythmic divisions of the H90's tempo. The H90's tempo can be adjust from the Tempo Menu.

This allows you to have your time based effects always be in sync to the H90's tempo. For example, you can specify a 1/4 note triplet delay time, change the H90's tempo from 120 BPM to 160 BPM, and you will now have a 1/4 note triplet delay time at 160 BPM.

- **Preset Tap Tempo:** While Tempo Sync is not enabled, assign the Footswitch of Preset A or B to "Tap". When you tap this footswitch, the Preset's time based parameters will be adjusted in mS or Hz depending on the algorithm. The tapped value will be momentarily displayed next to the "Tap" label.

This allows you to tap in different time based values for Preset A and B, without being synced to the H90's tempo.

Note

If either Preset A or B have Tempo Sync enabled, that Preset's Footswitch tap assignment will control the H90's tempo BPM. The Footswitch's LED will flash in time.

5.3. Quick Knob Assignments

In both Play Modes, the three Quick Knobs are mapped to various parameters within the currently loaded Program. There are two pages of Quick Knob assignments, which can be toggled by pressing any Quick Knob.



Fig. 5.7 Quick Knob assignments

The above example demonstrates the range of mappings the H90 is capable of per Program:

- Quick Knob 1 is assigned to the Program's Mix parameters
- Quick Knob 2 is assigned to the Delay Mix parameter of Preset A
- Quick Knob 3 is assigned to the Position parameter of Preset B

Tip

Any combination of Quick Knob assignments can be made to suit your Program or performance needs. You can map all of the Quick Knobs to the Parameters of Preset A or B, or mix things up between both Preset and Program-level parameters.

Press and hold any Quick Knob to access the assignment menu.



Fig. 5.8 Page 1 of the Quick Knob assignment menu



Fig. 5.9 Page 2 of the Quick Knob assignment menu; press any Quick Knob to toggle pages.

- The square at the top-left of the screen indicates the current Quick Knob assignment page. Press any Quick Knob to change the page.
- The letters P (Program-level parameters), A (Preset A parameters), and B (Preset B parameters) indicate to which part of the Program the listed parameters belong.
- Turn the associated Quick Knob to select which parameter to assign.
- Press and hold any Quick Knob, or press the Perform Knob to exit the Quick Knob Mapping menu. Note that new mappings are not saved until the program is saved.

6. EDIT MODES

6.1. Programs

Programs Edit Mode allows you to search through and audition the Programs on the H90.

Press the Programs Button to enter Programs Edit Mode. Press any Footswitch to exit.



Fig. 6.1 The upper right corner displays the List and location of the Program.

The three Quick Knobs filter the List of Programs:

- Quick Knob 1 selects the List. This includes both Factory Lists and User Lists.
- Quick Knob 2 selects the effect type for which to search.
- Quick Knob 3 selects the Algorithm for which to search.

Turn the Select Knob to scroll through the filtered List, which auto-loads each Program for quick auditioning.

Press the P LED Button to activate/bypass the Program. Press the A or B LED Button to activate/bypass each Preset within the Program.

6.1.1. Saving Programs

Press and hold the Programs Button to save a Program.



Fig. 6.2 Program save display

Turn Quick Knob 3 to select the List to which you'd like to save it. This defaults to the currently active Playlist. Note that Programs can be saved to User Lists, but not to Factory Lists.

Turn the Select Knob to pick which slot number to save to. This defaults to the currently loaded slot. There are 99 slots per List.

Once you've selected to which slot to save the Program, press the Perform Knob to begin renaming the Program.



Fig. 6.3 Program save naming display

- Move the cursor by turning the Select Knob or Quick Knob 1. Pressing Quick Knob 1 moves the cursor to the right.
- Select the character by turning the Perform Knob or Quick Knob 2. Pressing Quick Knob 2 switches the character set between lowercase, uppercase, numbers, and symbols.
- Delete a character by pressing Quick Knob 3.
- Press the Perform Knob to save your Program. Your renamed Program will be saved to the selected slot in the selected List, and will appear in Programs Edit Mode.

- Press the Select Knob to cancel the save operation.

6.2. Routing

Routing Edit Mode adjusts the routing of the currently loaded Program.

The H90's two Presets can be routed to process your signal in series or parallel for each Program. This is useful for a variety of applications:

- If your Program uses a Distortion and Wah Wah Preset you may want to process the distortion in series with the wah wah, meaning your audio is first processed by the distortion, and then the distorted signal is processed by the wah wah.
- Alternatively, if you are using a Program with Delay and Reverb Presets, you can process your audio through these two Presets in a parallel path, meaning the audio is sent to the delay and reverb simultaneously on two paths, and your delay and reverb sounds will not affect each other.

The Routing Edit Mode appears in one of two ways, depending on whether the Global Routing Configuration is set to Insert or Dual on the System Menu's Global page (Section 7.1).

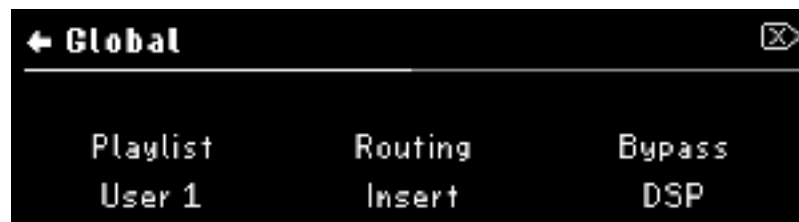

Fig. 6.4 Configure your Global Routing in the System Menu page.

Note

Changing your routing from Insert to Dual will automatically enable an alternate set of available Lists as well as your current Playlist. Programs and Lists that are created with Insert routing cannot be used with Dual routing, and vice versa.

Use H90 Control to convert the routing mode of your Programs and Lists by exporting and reimporting them. For example, export a Program or List that was created in Insert Mode, switch your H90 to Dual Mode, and then import that Program or List. H90 Control will prompt you to convert the Program or List to Dual Mode.

Press the Routing Button to enter Routing Edit Mode. Press any Footswitch to exit.

Pressing the P, A, or B LED Buttons will toggle active/bypass for the Program, Preset A, or Preset B.

Tip

When using Insert or Dual routing, press Quick Knob 1 to swap Presets A and B.

6.2.1. Insert Routing

The Insert Routing configuration allows Routing Mode to enable either two mono Inserts or one stereo Insert, which can be placed at any point along the signal path or turned off.

Insert Routing Options	
Series	Parallel
Pre A	Pre A & B
Parallel	Pre A
Mid	Pre B
Post B	Parallel

Insert Routing Options	
	Post A
	Post B
	Post A & B

To enable an Insert:

- Quick Knob 1: Turn to change the routing between series and parallel.

i Note

Programs with Presets routed in series will display  in the top right corner.



Fig. 6.5 Programs with Presets routed in series

Programs with Presets routed in parallel will display  in the top right corner.



Fig. 6.6 Programs with Presets routed in parallel

- Quick Knob 2: Turn to enable Insert 1 and adjust the Insert position. Press to active/bypass Insert 1.
- Quick Knob 3: Turn to enable Insert 2 and adjust the Insert position. Press to active/bypass Insert 2.

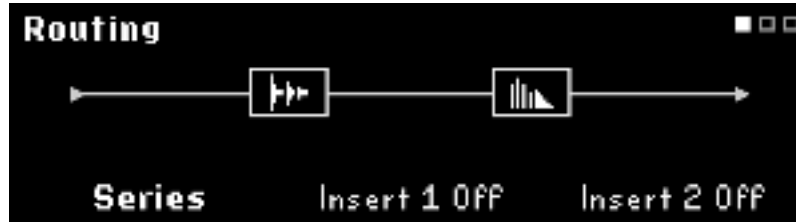

Fig. 6.7 Insert routing page with no active Inserts

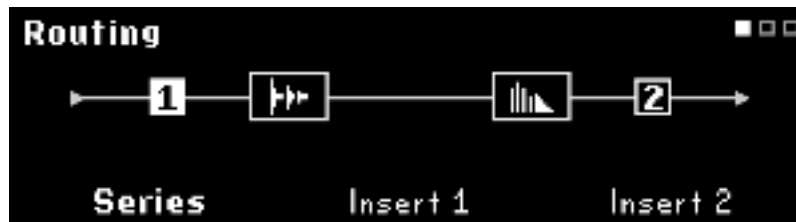

Fig. 6.8 Insert 1 pre-Preset A, Insert 2 post-Preset B

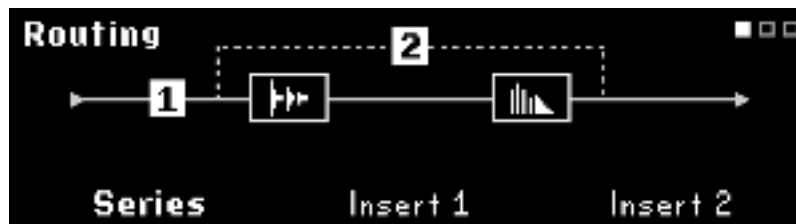

Fig. 6.9 Insert 1 pre-Preset A, Insert 2 in Parallel with Preset A & B

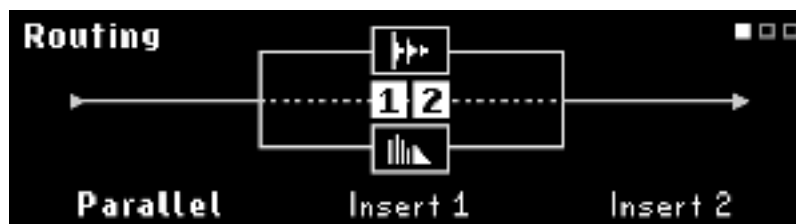

Fig. 6.10 Inserts 1 & 2 routed in Parallel with Preset A & B

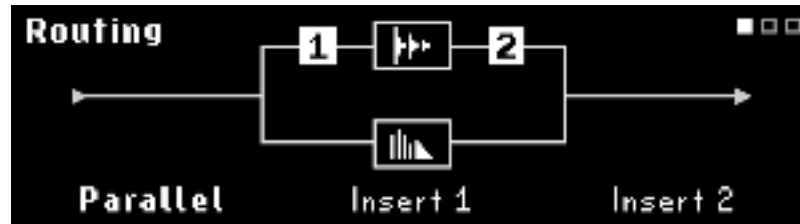

Fig. 6.11 Inserts 1 & 2 in Parallel, with Insert 1 pre-Preset A, and Insert 2 post-Preset A

Turning Quick Knob 3 completely clockwise will enable stereo insert 1-2, the position of which can then be adjusted using Quick Knob 2.



Fig. 6.12 Insert routing in Series with one stereo Insert

Each Insert has its own set of parameters: Send Level, Return Level, Mix %, Tails, Latency (from 0 samples to 512 samples), and Polarity (Normal/Inverted). Press the Routing Button or turn the Select Knob to scroll through the parameters.



Fig. 6.13 Page 1 of the Insert parameters

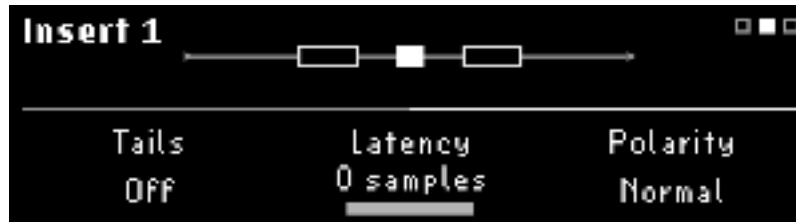

Fig. 6.14 Page 2 of the Insert parameters

Turn Tails on to allow the inserted device's effects to trail off naturally when bypassed. Turn Tails off to mute the insert immediately when bypassed.

! Latency Configuration

Latency only should be set when inserting digital devices. Analog devices do not have appreciable latency. Setting the latency properly will prevent comb filtering for the inserted effect. Consult the inserted device's documentation for its latency specifications.

To set the latency for an Insert:

- Invert the polarity.
- Set the mix to 50%.
- Bypass the external digital effect or adjust any mix knob so you only hear the dry signal.
- Adjust latency from 0 samples until the signal is silent or as quiet as possible.
- Disengage the polarity invert.
- When using an Eventide H9, set the insert latency to 109 samples.

Note

The H90 will automatically adjust to process audio in mono or stereo depending on the physical input and output connections. Insert routing will sum or mult the signal accordingly.

When using Stereo I/O:

- A mono insert at the end of the signal path will sum your output to dual mono.
- A mono insert in parallel to the H90's presets, the output will remain in stereo.

When using mono I/O:

- A stereo insert will mult the signal path to stereo, but the H90's presets will sum that signal back to mono.

6.2.2. Dual Routing

Dual Routing allows you to route two processing paths within your H90. This can be used to process two instruments separately through two different Presets, or to connect to an amplifier in a Pre/Post configuration using one Preset in your preamp section and one Preset in your amp's effects return.

Note

Programs using Dual Routing will display  in the top right corner.



Fig. 6.15 Programs using Dual Routing

- Turn Quick Knob 1 to change the routing position for Presets A and B on Paths 1 and 2.

- Quick Knob 2 and 3 are non-functional when Routing Mode is in Dual Routing configuration.
- Dual Routing enables two separate signal paths:
 - Path 1: Inputs 1/2 to Outputs 1/2
 - Path 2: Inputs 3/4 to Outputs 3/4

Dual Routing Positions		
Routing	Path 1	Path 2
Path 1 Series	Series	Thru
Path 1 Parallel	Parallel	Thru
Pre/Post	Preset A	Preset B
Path 2 Parallel	Thru	Parallel
Path 2 Series	Thru	Series

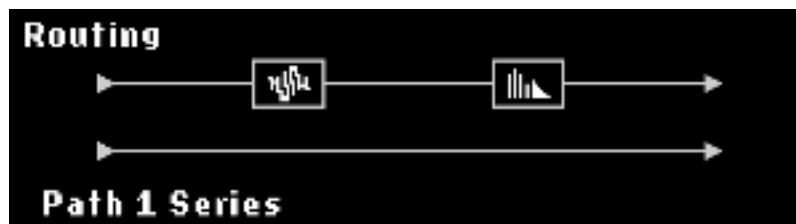

Fig. 6.16 Presets A & B in Series on Path 1



Fig. 6.17 Presets A & B in Parallel on Path 1

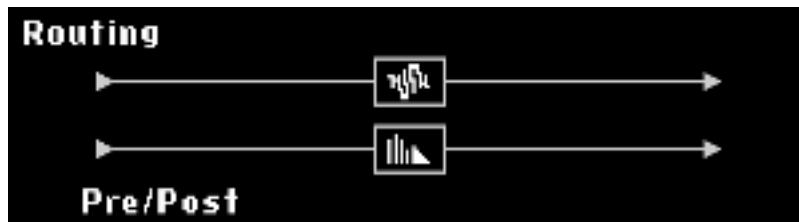

Fig. 6.18 Dual Routing in Pre/Post

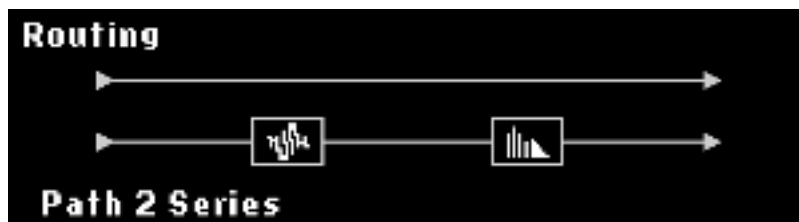

Fig. 6.19 Presets A & B in Series on Path 2



Fig. 6.20 Presets A & B in Parallel on Path 2

6.3. Presets

Presets Edit Mode allows you to quickly hear the effects of different Algorithm Presets on the currently loaded Program.

Press the Presets Button to enter Presets Edit Mode. Press again to toggle the selection between Presets A and B.



Fig. 6.21 Preset Edit Mode displaying Preset A



Fig. 6.22 Preset Edit Mode displaying Preset B

The three Quick Knobs can be used to filter the List of Presets:

- Quick Knob 1 selects the List through which to search. This includes both Factory Lists and User Lists, and also narrows down the other two Quick Knobs' filters.
- Quick Knob 2 selects the Effect Type for which to search.
- Quick Knob 3 selects the Algorithm filter.

Turn the Select Knob to scroll through the filtered List, which auto-loads each Preset into the selected A or B slot for quick auditioning. The original Preset will remain in the List regardless of the filters, until you save the Program.

Press the P LED Button to activate/bypass the Program. Press the A or B LED Button to activate/bypass each Preset within the Program.

Press any Footswitch to exit Presets Edit Mode.

6.3.1. Saving Presets

Press and hold the Presets Button to save a Preset.



Fig. 6.23 Preset save display

Renaming Presets works the same way as renaming Programs.

- Move the cursor by turning the Select Knob or Quick Knob 1. Pressing Quick Knob 1 moves the cursor to the right.
- Select the character by turning the Perform Knob or Quick Knob 2. Pressing Quick Knob 2 cycles the character set through lowercase, uppercase, numbers, and symbols.
- Delete a character by pressing Quick Knob 3.
- Press the Perform Knob to save your preset to the Preset Library, which can be searched through in Presets Edit Mode.
- Press the Select Knob to cancel.

If a preset already exists with the name you have chosen, you will be prompted to overwrite the existing preset.

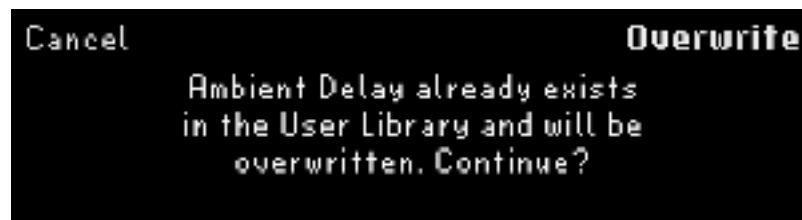

Fig. 6.24 Existing preset prompt

Note

Factory Presets must be renamed and saved as a new User Preset to the Library.

6.4. Parameters

Parameters Edit Mode allows you to adjust and map the Program-level and Preset parameters.

Press the Parameters Button to enter Parameters Edit Mode. Press again to cycle through P/A/B parameter groups. Turn the Select Knob to scroll through the pages of parameters in the current group. Adjust the parameters by turning the Quick Knobs.

- Press the P LED Button to view the Program's general parameters. Press it again to bypass/activate the Program.



Fig. 6.25 Parameter Edit Mode displaying the parameters of the Program

- Press the A LED Button to view the parameters for Preset A. Press it again to bypass/activate Preset A.



Fig. 6.26 Parameter Edit Mode displaying the parameters for Preset A

- Press the B LED Button to view the parameters for Preset B. Press it again to bypass/activate Preset B.

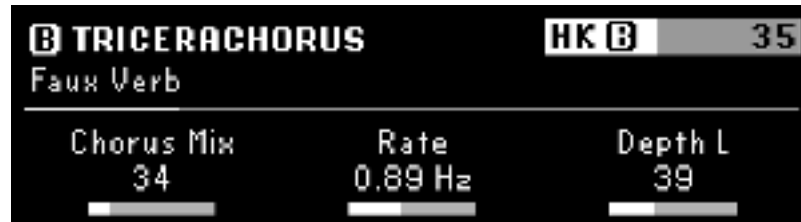

Fig. 6.27 Parameter Edit Mode displaying the parameters for Preset B

6.4.1. Mapping

The H90 offers a wide variety of parameter mapping for internal and external controllers. All of your custom parameter mapping will be configured in Parameters Edit Mode.

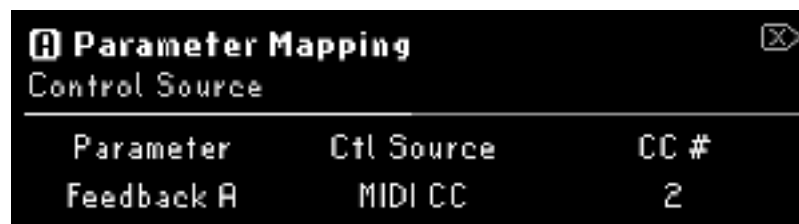

Fig. 6.28 External Mapping menu

To map a parameter:

- Press and hold the Quick Knob that controls the parameter you wish to map.
- Turn Quick Knob 2 to select a control source.
- Turn the Select Knob to view the Control Range menu. Turn Quick Knobs 1 and 2 to set the Start/End or Minimum/Maximum values of the controller.
- You can reverse the direction of your external controller by adjusting the End point to be before the Start point. For example, setting the End point to zero and Start point to 100 will result in the Heel of your expression pedal being 100 and Toe of your expression pedal being 0.

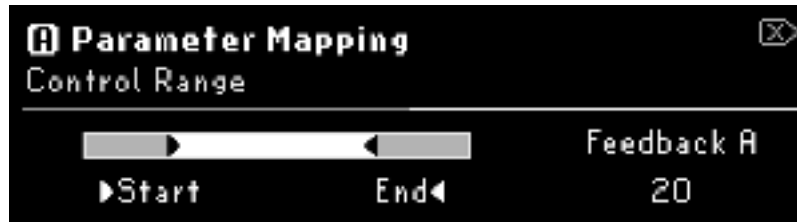

Fig. 6.29 Control Range menu

Remember!

Begin at the beginning and go on till you come to the end: then stop.

- Turn Quick Knob 1 to choose another parameter to map.
- To un-map a parameter, set the Control Source to “Off”.
- Press the Perform Knob to exit the mapping menu.

Tip

If you'd like to map many Program-level or Preset parameters at once, press the P/A/B LED to quickly jump to other Preset or Program mapping options without ever leaving the mapping menu.

6.4.2. HotKnob

The HotKnob can be used to map multiple parameters to a single controller, much like the ribbon controller from the H9. The H90 expands upon this control by giving you three HotKnobs; P, A, and B.

Press the Parameters Button to cycle through the different parameter view pages, and this will determine which HotKnob is being used. Note that in Perform Mode, HotKnob P will always be used.

To map a parameter to a HotKnob:

- Follow the above instructions to map a parameter and select a HotKnob as the control source.
- If you selected HotKnob P, press the P LED to view the Program parameters page, and turn the Perform Knob to control HotKnob P.

- If you selected HotKnob A or B, press the A or B LED to view that Preset's parameters page, and turn the Perform Knob to control HotKnob A or B.

Tip

A HotKnob can also be mapped to internal or external controllers. This can be useful for mapping both HotKnobs A and B to HotKnob P and control both HotKnobs simultaneously, or mapping a HotKnob to an expression pedal for easy control. You can also map a HotKnob to a Quick Knob using the Quick Knob Assignments menu.

6.4.3. HotSwitch

A HotSwitch can be thought of as a snapshot of a group of parameters. If the chorus of your song needs higher gain and more delay, map those parameters to a HotSwitch and engage it for the chorus. Then, disengage to go back to the previous parameters, or activate another HotSwitch with different parameters for the second verse.

There are three HotSwitches, one for each P, A, and B Footswitch. Mapping parameter values to a HotSwitch allows you to use a Footswitch in Perform Mode to toggle those mapped values. Note that only one HotSwitch can be active at a time.

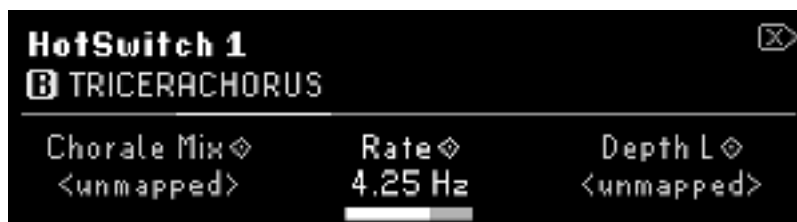

Fig. 6.30 HotSwitch mapping menu displaying the parameters for HotSwitch 1

To map a HotSwitch:

- Press the Parameters Button to enter Parameters Edit Mode.
- Press and hold the P, A, or B LED Button to map its respective HotSwitch.
- Press a Quick Knob to assign the parameter to the HotSwitch. Turn the Quick Knob to change the value of that parameter.
- Turn the Select Knob to view other Preset or Program-level parameters to be mapped.

- Press the P/A/B LED Button to jump to other groups of Preset or Program-level parameters to be mapped.
- Press the Quick Knob of a mapped parameter to un-map it.
- Press and hold another LED Button to map a different HotSwitch without exiting the mapping menu.
- Press the Perform Knob to exit the HotSwitch mapping menu.

6.4.4. Tempo Sync

Press the Presets and Parameters Buttons together to toggle Tempo Sync on/off.



Fig. 6.31 A metronome icon will indicate that Tempo Sync has been enabled.

Tempo Sync determines whether certain parameters will display tempo-synced subdivisions, or a continuous range of rates. For example, UltraTap's Length parameter can display milliseconds or subdivisions, while UltraTap's Speed parameter can display Hertz (cycles per second) or subdivisions.

Tempo Sync can be applied to the entire Program, or to individual Presets within a Program.

- Toggling Tempo Sync while a Preset's parameter group is selected will enable/disable Tempo Sync for that individual Preset.
- Toggling Tempo Sync while the Program's parameter group is selected will enable/disable Tempo Sync for both Presets.

Tip

Tap tempo can be used to adjust time based parameter values with Tempo Sync off. See Tap Tempo for more information.

7. SYSTEM MENU

Press and hold the Programs and Routing Buttons simultaneously to enter the System Menu. Press the Perform Knob to exit.

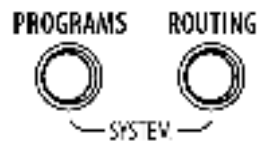

Fig. 7.1 Press and hold the Programs and Routing Buttons simultaneously

- Navigate between pages either by turning the Select Knob, or by pressing the Programs or Routing Button.
- Press the Select Knob to select a page. Press it again to exit that page and go back to the main System Menu.



Fig. 7.2 System Menu display

7.1. Global

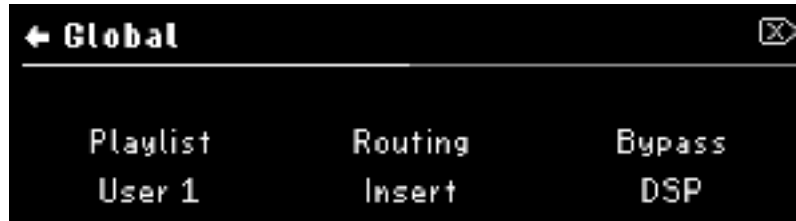

Fig. 7.3 Page 1 of the Global settings

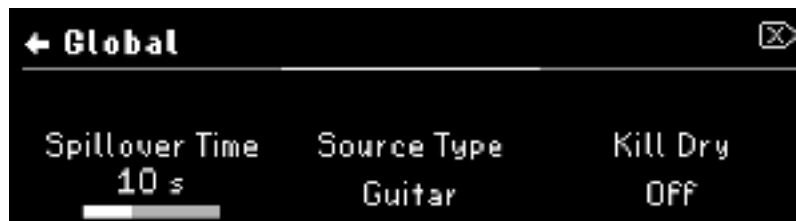

Fig. 7.4 Page 2 of the Global settings

Playlist

Select which User List you'd like to use in Select Mode.

Note

Only User Lists can be designated as the Playlist, and there can only be one active Playlist. Factory Lists cannot be the Playlist, but they are searchable in Programs Edit Mode.

Routing

The H90 contains two Global Routing Configurations:

1. Insert; for affecting one signal path and enabling the insertion of external effects.
2. Dual; for affecting two signal paths separately.

These two Global Routing Configurations affect Routing Edit Mode's available options.

Turn Quick Knob 1 to change the Global Routing Configuration. A prompt will appear to confirm or cancel the change. Press Quick Knob 3 to confirm, or press Quick Knob 1 to cancel.

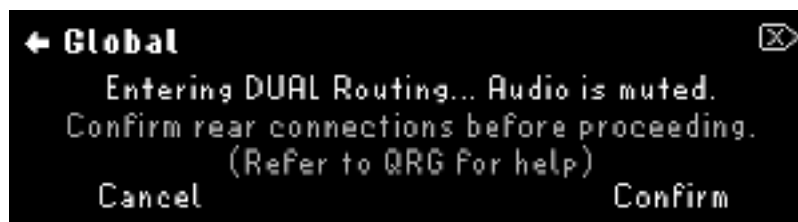

Fig. 7.5 A prompt will appear to ensure you'd like to change your routing configuration

Program Bypass Mode

This determines the signal path when the Program is bypassed.

- DSP: Keeps signal running through the DSP. Allows bypass tails. Inserts are bypassed when Program is bypassed.
- Relay: Directly connects inputs to outputs with physical relay switches. Disables bypass tails. Inserts are bypassed when Program is bypassed.
- AB Only: Bypassing the Program will only bypass Presets A & B. The inserts will still be active. This setting is useful for Wet/Dry Amplifier configurations and other setups that rely on the inserts always being active.

Note

When using Dual Routing, Relay bypass is not possible for Path 2 (I/O 3-4) but can still be used for Path 1 (I/O 1-2). If no Presets are being used on Path 1, the relay will automatically be enabled.

Spillover Time

This determines how long the bypass tails will be enabled when switching Programs. Configurable from 0 to 30 seconds.

Source Type

This determines how the pitch tracking, filters, and tone controls will respond to the audio source. While the source names suggest specific instruments, these can also be thought of as the sonic range of your audio source.

- Lead (Soprano)
- Guitar (Alto)
- Bass (Tenor)
- Sub (Bass)

Kill Dry

This is the global kill dry setting that all Programs and presets will subscribe to. If a Program or Preset's kill dry setting is set to Global, it will reflect this setting of on or off.

Pedal Control

Global Pedal Control allows you to define external controllers such as aux switches and expression pedals that will always affect the H90, regardless of what Program is loaded. For example, if you'd like Aux Switch 1 to always perform the Load action, you can configure this using the Global Pedal Control.



- Parameter: Turn Quick Knob 1 to select a parameter.
- Control Source: Turn Quick Knob 2 to select control source for the currently selected parameter.

Note

Check out the Global Mapping Chart (Section C) for a full list of available mappings.

7.2. I/O

In/Out Levels

Individually adjust inputs and outputs between instrument level and line level. An LED grid on the back of the H90 also indicates which jacks are set for line level signals.

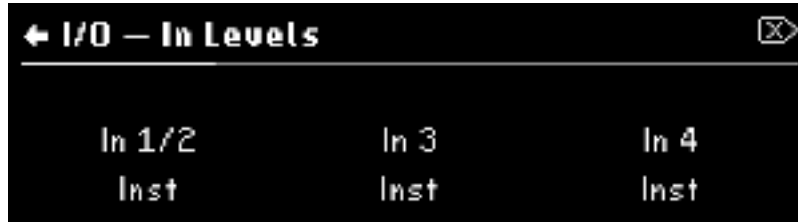

Fig. 7.6 Input level display



Fig. 7.7 Output level display

Exp/Ctl

Set pedal 1 and/or 2 to expression pedal or switch using Quick Knob 1 and 2.

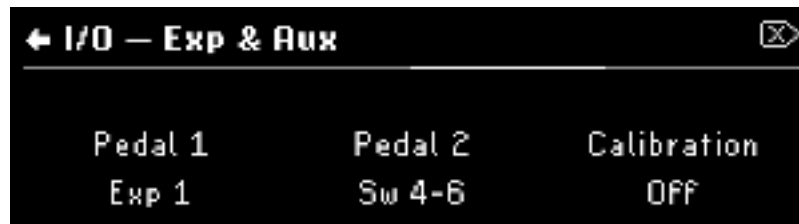

Fig. 7.8 Exp & Aux setup display

Turn Quick Knob 3 to enable calibration.

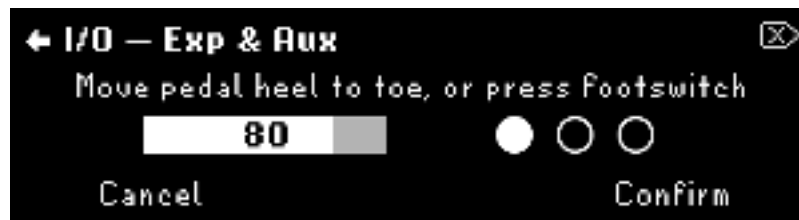

Fig. 7.9 This example shows one expression pedal and one aux switch being calibrated.

Jacks

Displays which inputs and outputs are connected.

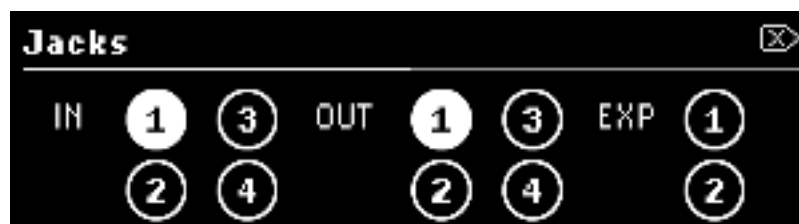

Fig. 7.10 This example shows that input 1 and output 1 are being used

Output Mode

Determines the H90's routing behavior:

- **Auto:** The H90's algorithms will automatically determine the correct mono/stereo and summing behavior based off of what jacks are physically connected.
 - Mono input/output will result in all algorithms processing in mono. Use I/O 1, I/O 2 is not supported for mono operation.
 - Mono input/Stereo output will result in all algorithms processing in stereo. Use input 1 for this setup, input 2 is not supported for a mono/stereo configuration.
 - Stereo input/output will result in all algorithms processing in stereo.
 - Stereo inputs/Mono output will result in a mono summed output on output 1. Use output 1 for this setup, output 2 is not supported for stereo/mono summing.
 - Mono inserts will sum audio to mono. Algorithms will process in stereo when using mono inserts with mono/stereo or full stereo configurations. If a mono insert is at the end of your signal path the output will be summed to mono.
 - All of the above information also applies to I/O 3-4 for Path 2 when using Dual Mode. For example, use input 3 and outputs 3-4 for a mono/stereo setup. I/O 4 is not supported for mono or stereo/mono configurations.
- **Force Mono:** The H90's dry path and all of the algorithm processing will be summed to mono, regardless of what physical jacks are connected. Outputs 1-2 will be a duplicate copy of the mono summed signal. This is useful if you have your H90 connected in stereo on your pedal board or patch bay and you do not want to disconnect the input/output jacks for mono operation.

7.3. Bluetooth

Note

H90 software version 1.7.5+ is required to enable Bluetooth functionality.

The H90 can pair and connect to your Mac, iPad, and iOS device via Bluetooth. This allows you to connect to H90 Control (Mac/iPad only) or send MIDI messages via a DAW or 3rd party MIDI control app.

Tip

Press and hold the Programs and Routing buttons to enter the H90's System Menu, then locate the Bluetooth menu to enable Bluetooth and pair/connect your H90.



Fig. 7.11 Press and hold the Programs and Routing buttons to enter the H90's System Menu.

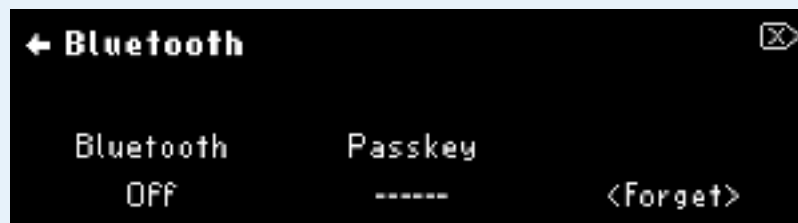

Fig. 7.12 Enter the Bluetooth menu to enable Bluetooth on your H90.

Bluetooth On/Off

Turn Quick Knob 1 to turn the H90's Bluetooth advertising on/off. This allows you to pair and connect with Bluetooth host devices such as a Mac computer or iOS device. The left Bluetooth LED illuminates blue when on.

Passkey

Displays a pairing passkey while you are pairing with a new host device.

Forget

Turn Quick Knob 3 to forget all paired devices.

Tip

Once you have forgotten a host device on the H90, you must also forget the H90 Bluetooth device from the Host Device's Bluetooth settings. You must then follow the instructions to pair the device again.

H90 Control connection tips:

- Your H90 will show up as two devices in H90 Control depending on the connection method: USB or Bluetooth. This will be indicated by the connection icon below the device's image.



Fig. 7.13 The USB Device can be seen on the left, while the Bluetooth device can be seen on the right.

- You cannot update your H90 via Bluetooth; you must use a USB connection to update. Click the cloud icon in the bottom right corner of the USB device to update.
- Do not connect your H90 to multiple devices running H90 Control via Bluetooth and USB simultaneously.

7.3.1. macOS connection:

1. Turn Quick Knob 1 to turn the H90's Bluetooth on. The left Bluetooth LED will illuminate blue.
2. Open H90 Control, and click the Bluetooth pairing button. This will open the macOS Bluetooth Configuration menu.

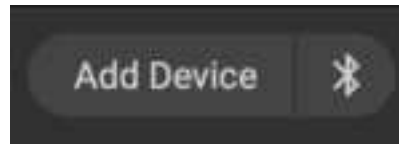

Fig. 7.14 Click the Bluetooth Icon to pair your H90 with your Mac.

3. In the Bluetooth Configuration menu, locate your H90 and click the “connect” button.



Fig. 7.15 Click the “connect” button.

4. You will be prompted with a connection request pop-up. Select the “connect” button.



Fig. 7.16 Click the “connect” button to pair your H90 to your Mac.

5. You will now be prompted to enter a 6-digit code that is displayed on the H90's Bluetooth menu under the Passkey. Enter the Passkey on your Mac and click the “connect” button. Your H90 should pair to your computer successfully. The right Bluetooth LED on the H90 will illuminate blue to indicate it is connected to a host.

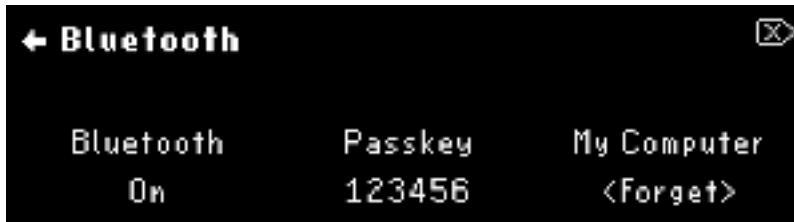

Fig. 7.17 The passkey will be displayed on your H90.

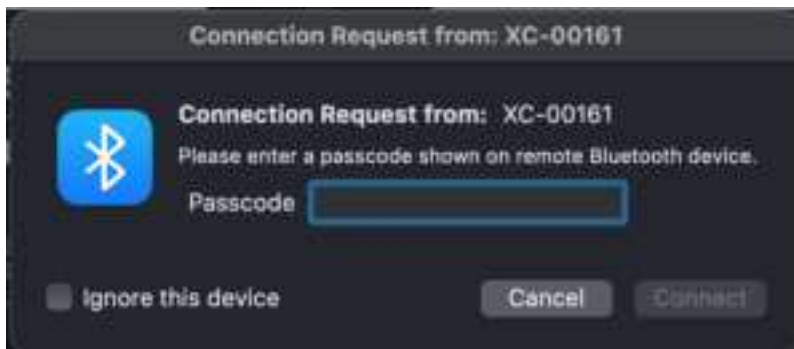

Fig. 7.18 Enter the 6-digit code to pair with your device

6. In H90 Control, click "Add Device" followed by "Select Port".

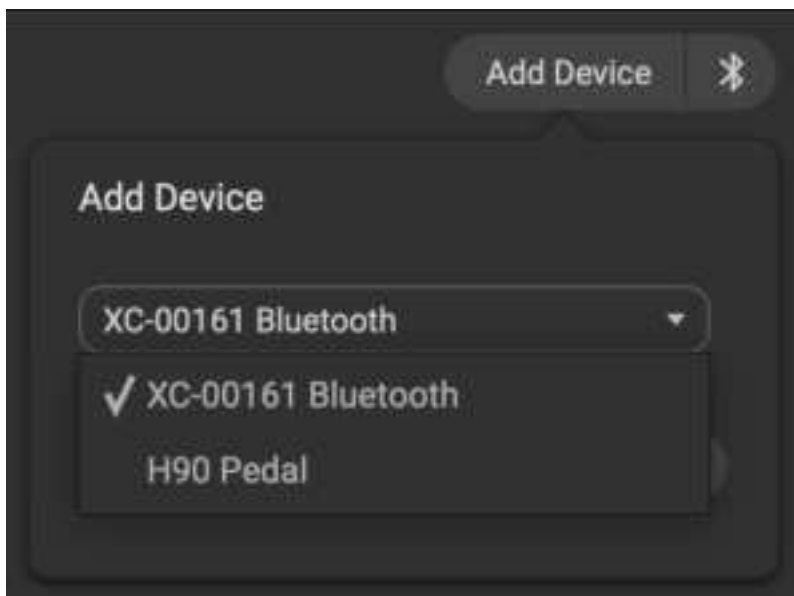

Fig. 7.19 Select the H90 Bluetooth Device to add it.

- Select the H90 Bluetooth device, and click “Add”.
- 7.
 8. You can now connect your H90 to H90 Control via Bluetooth.
 9. Additionally, your H90 Bluetooth device will now be available as a MIDI device in your DAW.



Fig. 7.20 The H90 Bluetooth device is now available in Ableton Live.

i macOS pairing tips:

1. If you turn your Mac's Bluetooth off, or disconnect the H90 from the Bluetooth Configuration menu, this will break the Bluetooth connection and turn the H90's Bluetooth off. Turn it on again in the H90's Bluetooth menu to reconnect.
2. If you choose to "forget" the Mac your H90 is paired with, you must also remove the H90 Bluetooth device from the Mac Bluetooth settings before your H90 can reconnect. To do this, go to the Mac "Bluetooth Preferences" menu, locate the H90 Bluetooth device, right-click it and select "Remove". After this, repeat the instructions to pair using H90 Control.



Fig. 7.21 Remove the H90 from your Mac's Bluetooth settings before pairing again.

3. Depending on your OS version, you may or may not need to manually reconnect your H90 for it to be available in H90 Control. This will be apparent if your device shows up as "Not Available". If you need to connect again, simply click the Bluetooth button in H90 Control and press "connect" on the device. This should make the device available once connected.



Fig. 7.22 This device is not available and needs to be reconnected.

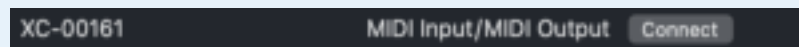

Fig. 7.23 Click connect to make the device available in H90 Control.

7.3.2. iPad Connection

1. [Download and install H90 Control from the App Store.](#)
2. Open H90 Control and click the Bluetooth icon in the top right corner to begin pairing your H90.

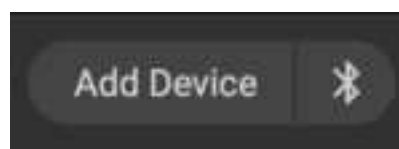

Fig. 7.24 Click the Bluetooth Icon to pair your H90 with your iPad.

3. Select your H90 from the iPad's Bluetooth MIDI Devices menu.

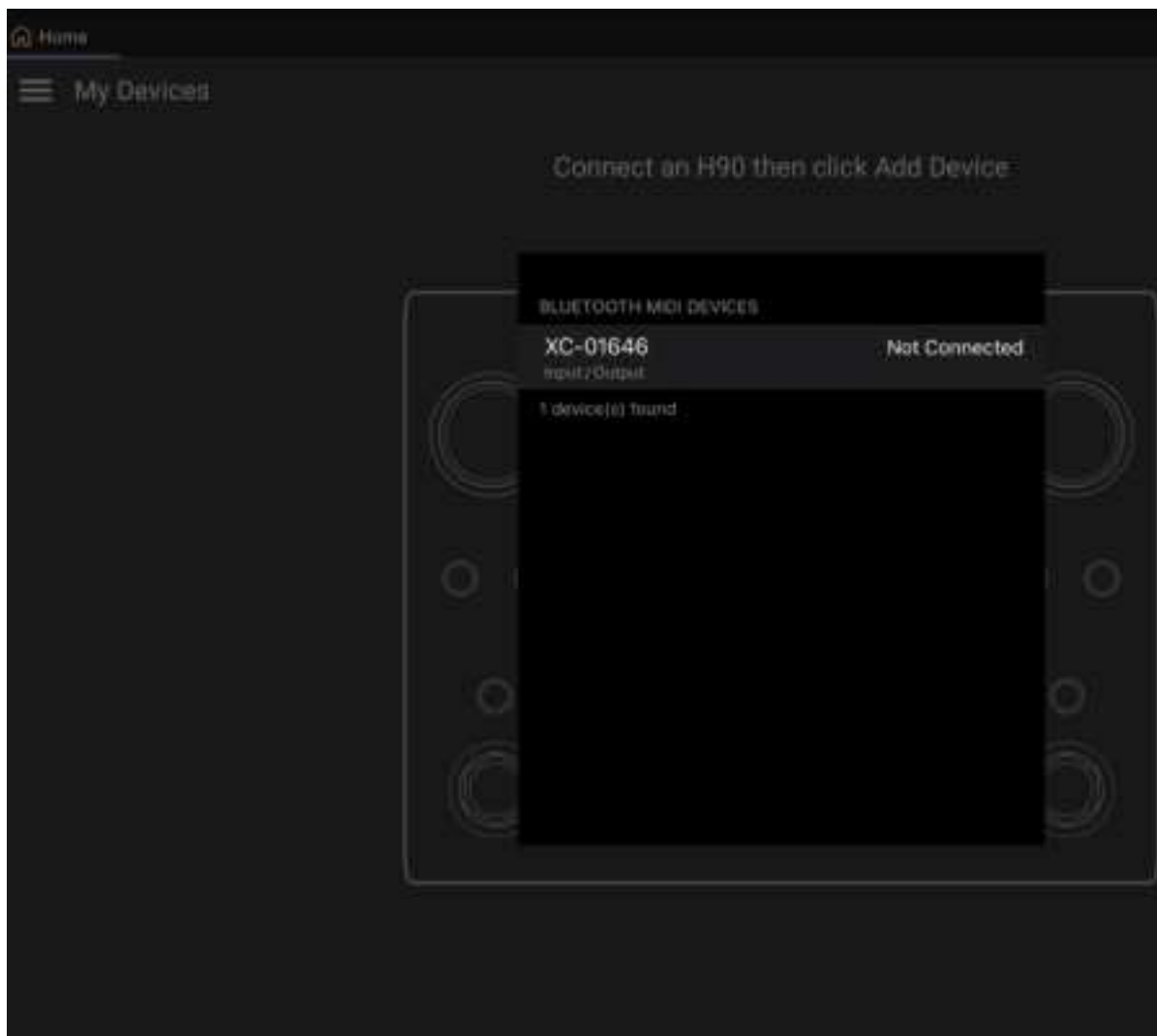

Fig. 7.25 Select your H90 to begin the pairing process.

4. You will be prompted to enter a 6-digit code that is displayed on the H90's Bluetooth menu under the Passkey.

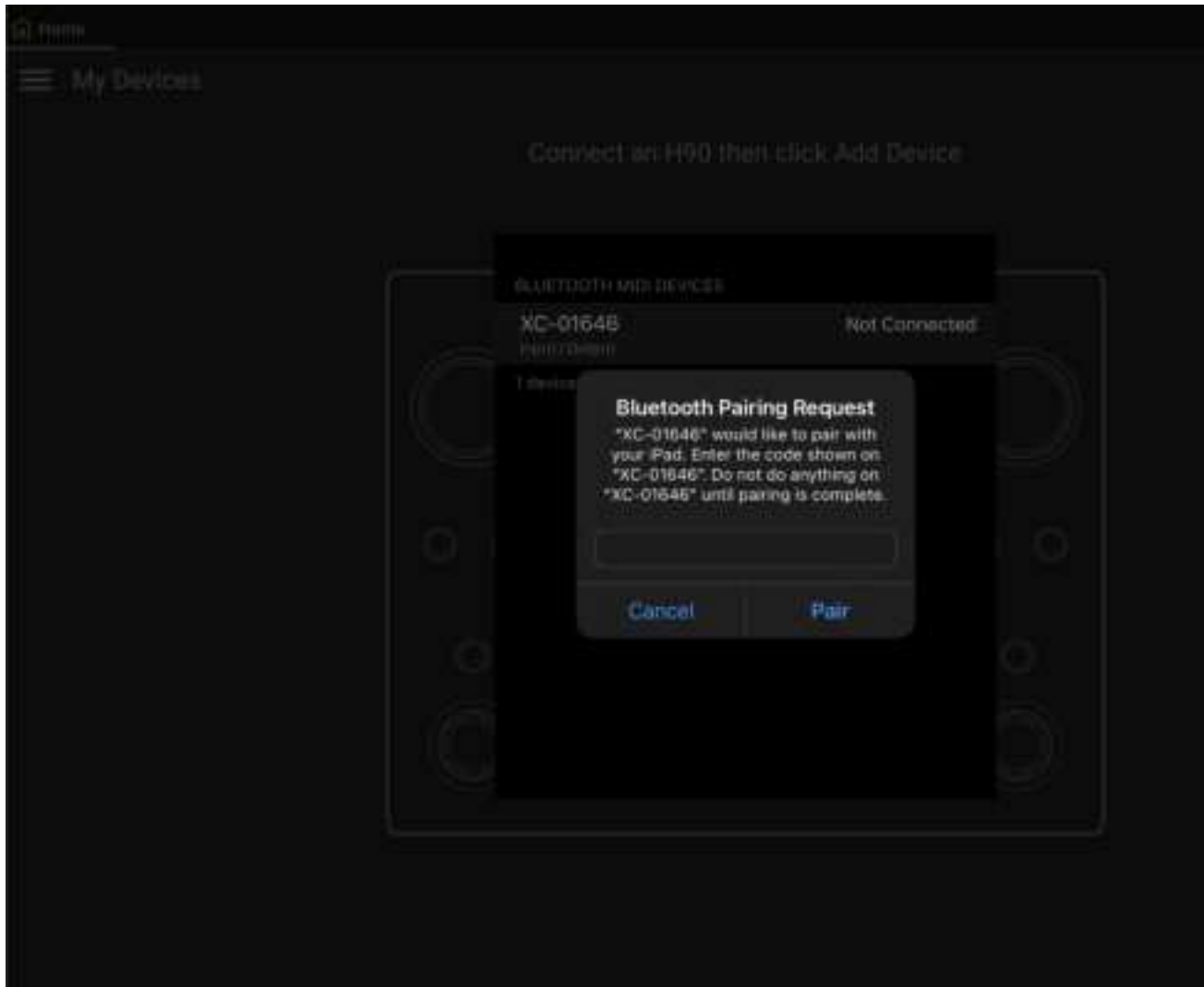

Fig. 7.26 Enter the Passkey displayed on the H90.

5. Enter the Passkey on your iOS device and click the "Pair" button.
6. In H90 Control, click "Add Device" followed by "Select Port".

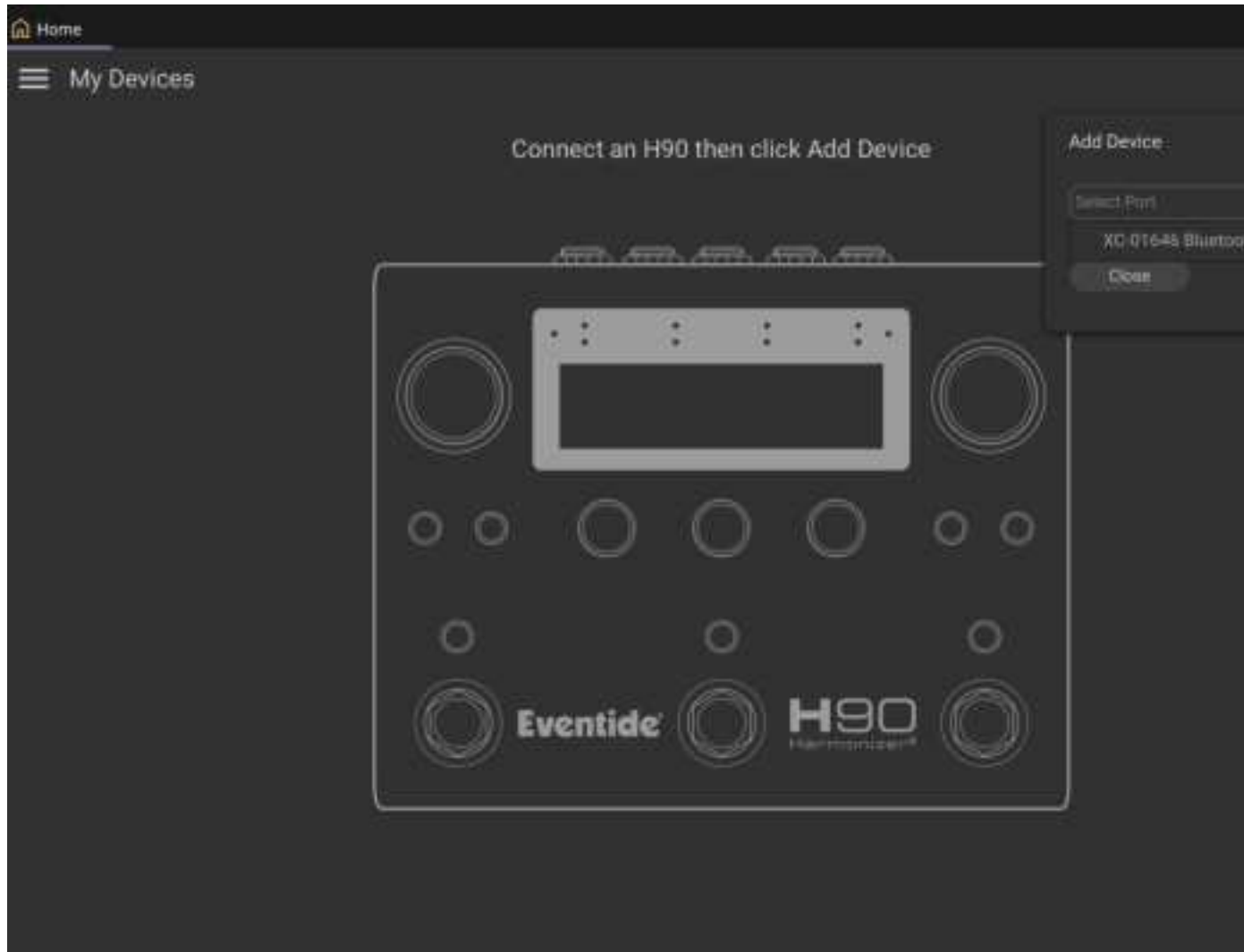

Fig. 7.27 **Select the H90 Bluetooth Device to add it.**

7. Select the H90 Bluetooth device, and click “Add”.
8. Your H90 Bluetooth device will now be connected to your iPad. The right Bluetooth LED on the H90 will illuminate blue to indicate it is connected to a host.
9. You can now control your H90 using your iPad with H90 Control.

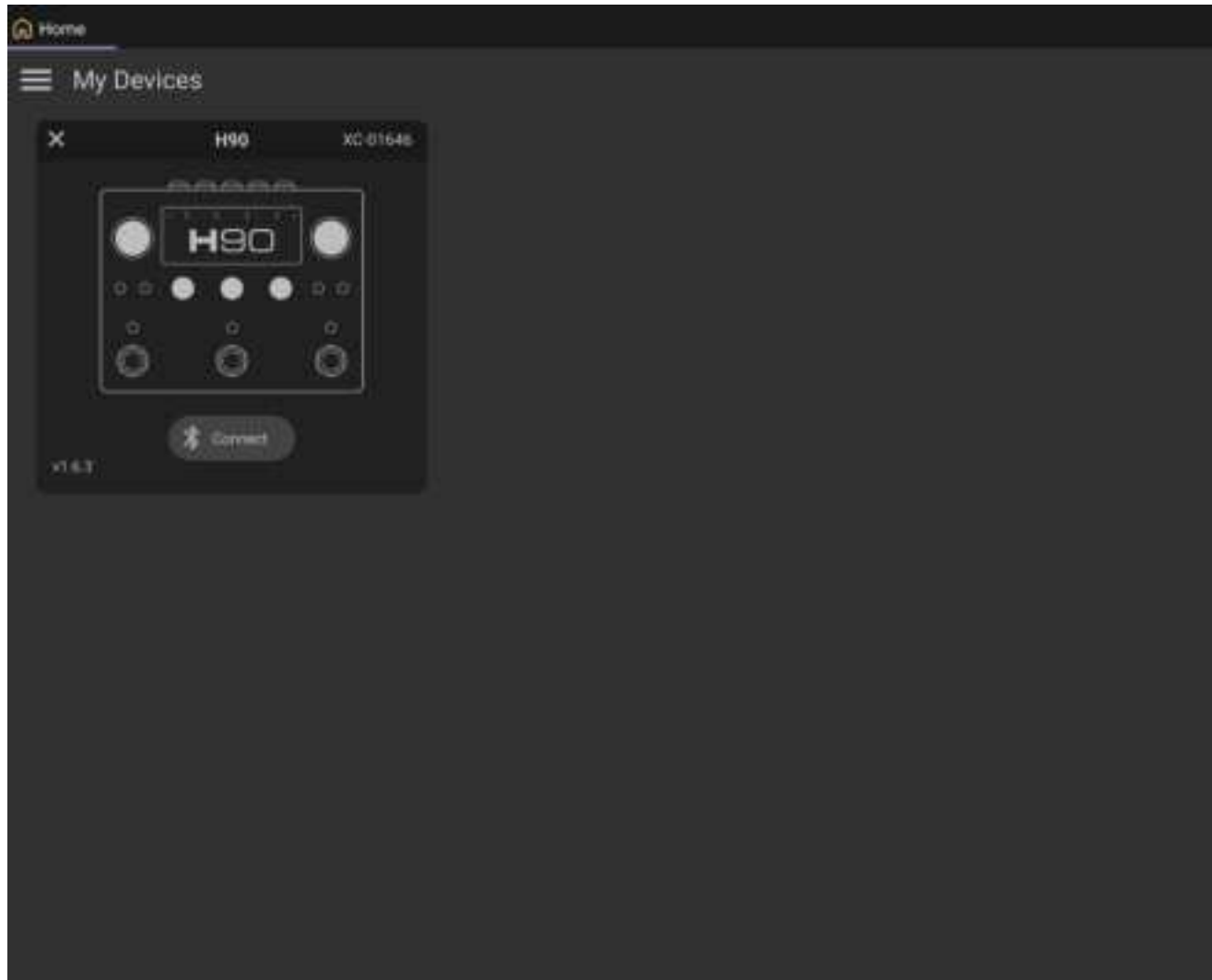

Fig. 7.28 Click “connect” to connect your H90 with H90 Control.

10. Additionally, the H90 Bluetooth device will now be available as a MIDI device in your DAW or MIDI control app.

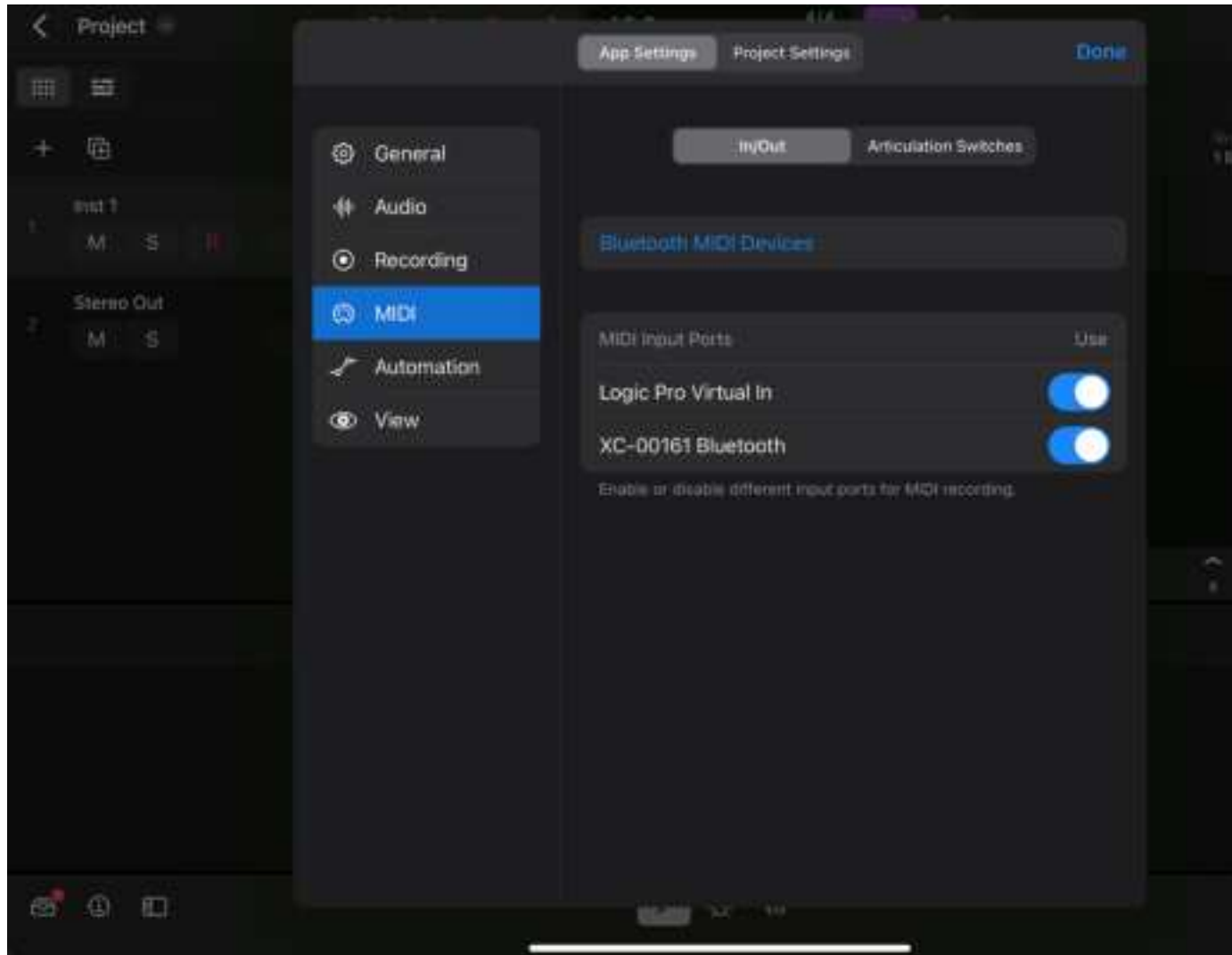

Fig. 7.29 The H90 Bluetooth device is now available in Logic.

! iPad pairing tips:

1. If you turn your iPad's Bluetooth off, this will break the Bluetooth connection and turn the H90's Bluetooth off. Turn it on again in the H90's Bluetooth menu to reconnect.
2. If you choose to "forget" the iPad your H90 is paired with, you must also remove the H90 Bluetooth device from the iPad's Bluetooth settings before your H90 can reconnect. To do this, go to the Settings > Bluetooth, locate the H90 Bluetooth device, click the "i" icon, and select "Forget This Device". After this, repeat the instructions to pair your H90 with the iPad using H90 Control.

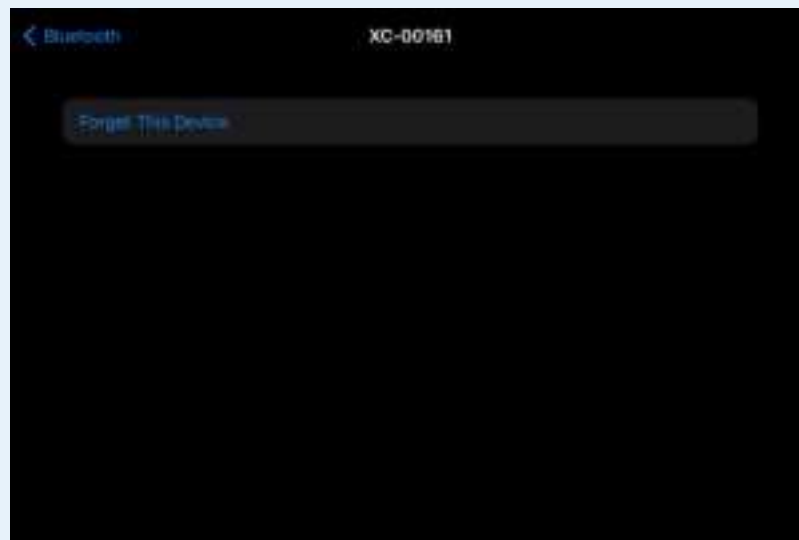

Fig. 7.30 Forget the H90 on your iOS device before pairing again.

3. You cannot update your H90 using an iPad; you must use a computer with a USB connection to update.
4. You cannot connect your H90 to your iPad via USB and Bluetooth simultaneously.

7.3.3. iOS Connection

1. To pair your H90 with an iOS device, you must download a 3rd party Bluetooth MIDI pairing app. We recommend [Korg - BLE MIDI](#).

2. Open the Bluetooth MIDI pairing app; your H90 should be available as a device to connect to.



Fig. 7.31 **Select the H90 to pair with your iOS device.**

3. Select the H90 and you will be prompted to enter a 6-digit code that is displayed on the H90's Bluetooth menu under the Passkey.

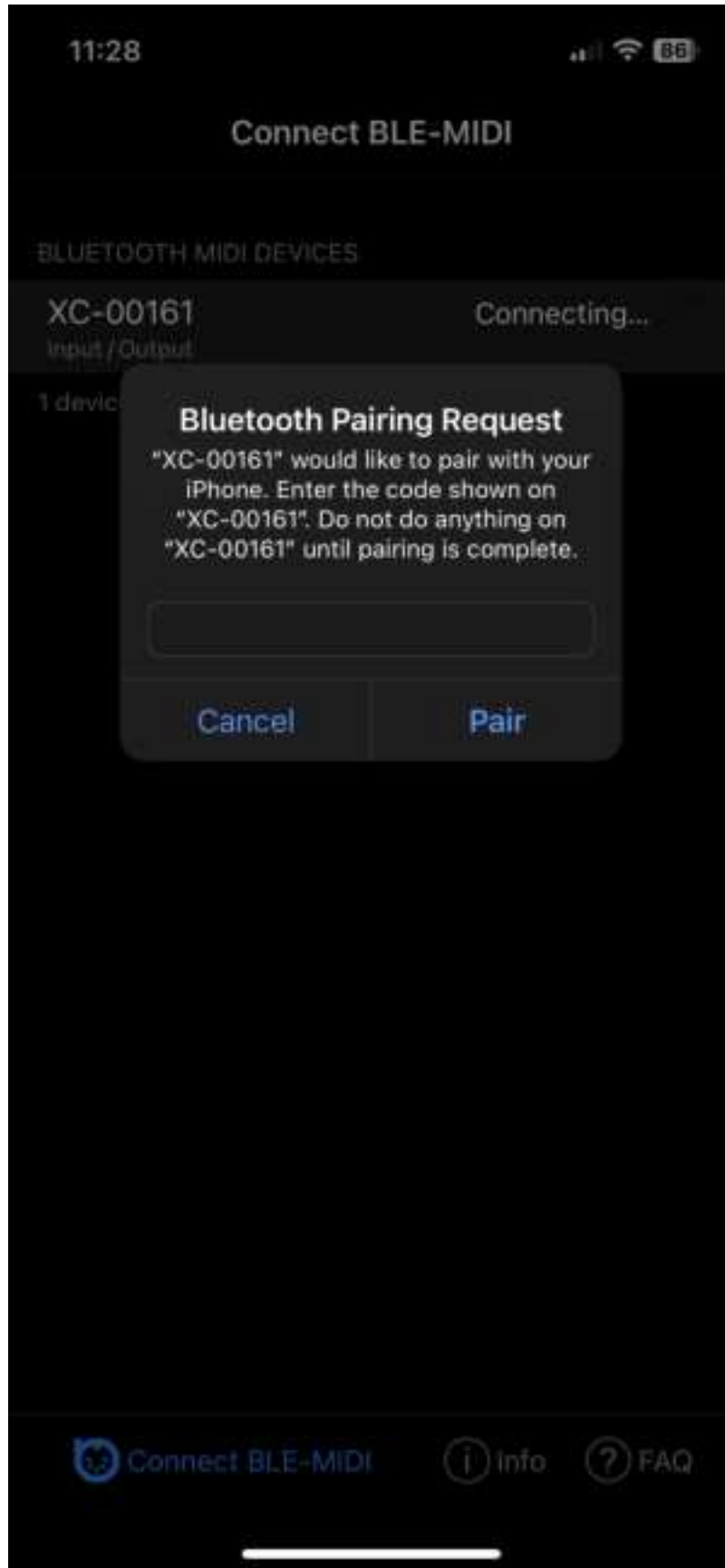

Fig. 7.32 **Enter the Passkey displayed on the H90.**

4. Enter the Passkey on your iOS device and click the “Pair” button.
5. Your H90 Bluetooth device will now be connected to your iOS device. The right Bluetooth LED on the H90 will illuminate blue to indicate it is connected to a host.
6. You can now send MIDI messages from your iOS device to the H90 using a MIDI control app.

! iOS pairing tips:

1. H90 Control is only available for Mac/iPad.
2. If you turn your iOS device's Bluetooth off, this will disconnect the Bluetooth connection and turn the H90's Bluetooth off. Turn it on again in the H90's Bluetooth menu to reconnect.
3. If you choose to "forget" the iOS device your H90 is paired with, you must also remove the H90 Bluetooth device from the iOS Bluetooth settings before your H90 can reconnect. To do this, go to the Settings > Bluetooth, locate the H90 Bluetooth device, click the "i" icon, and select "Forget This Device". After this, repeat the instructions to pair your H90 with the iOS device using the Bluetooth MIDI pairing app.

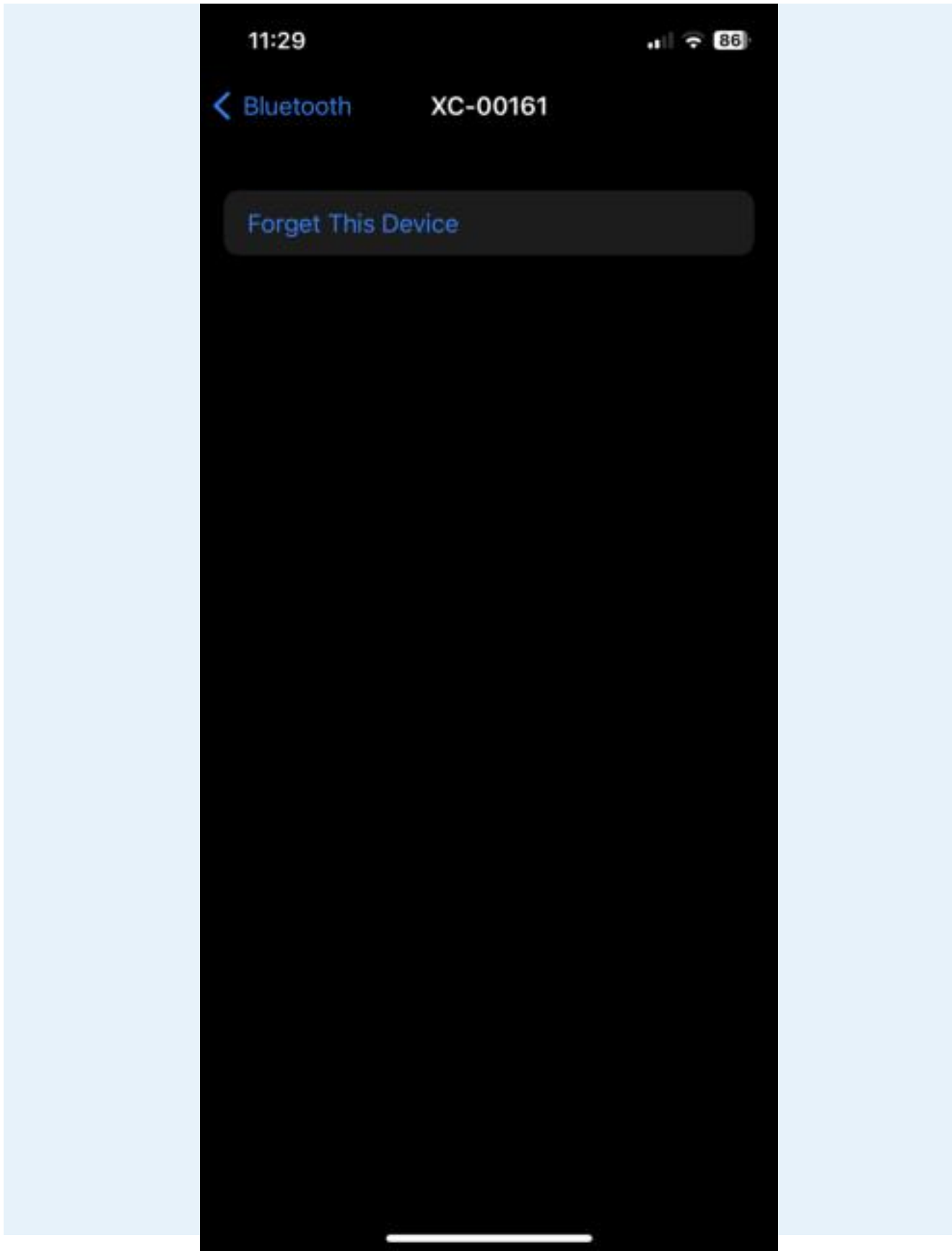

Fig. 7.33 **Forget the H90 on your iOS device before pairing again.**

7.3.4. Pairing your H90 to multiple devices

- The H90 can pair with multiple host devices (Mac, iPad, iOS device, etc.) but it can only connect to one host device at a time.
- Some host devices implement auto-connect behavior (i.e. iPad/iPhone/macOS 13+). When multiple paired devices are in range, the first one to auto-connect wins. This may not be desirable if one of your host devices is “stealing” the Bluetooth connection from the other device. This can be resolved in two ways:

1. Only pair your H90 with one host device at a time. When you want to switch to a new device, you should forget the H90 Bluetooth device and Host device from both ends.

Example: When you are not using your H90 with your Mac, forget the Mac on the H90 and forget the H90 Bluetooth device in the Mac’s Bluetooth settings. You can now pair your H90 with your iPad and the Mac Bluetooth connection will not interfere.

2. Turn Bluetooth off on any devices which you do not want your H90 to connect to. This allows you to stay paired with multiple host devices, but you must manually turn Bluetooth on/off for the device that you wish to connect to.

Example: When you are not using your H90 with your Mac, turn your Mac’s Bluetooth off so the Bluetooth connection will not interfere when you try to connect to your iPad. When you want to use your Mac again, turn the Mac’s Bluetooth back on, and turn Bluetooth off on your iPad.

7.3.5. Bluetooth System Requirements

- Device must support Bluetooth LE 4.2+ to use H90 Control. BLE 4.0+ will work for standard MIDI only. Earlier versions of Bluetooth/Bluetooth Classic will not work and are not supported.
- iPads must run iPadOS 15 or later to use H90 Control
- Macs must run macOS 11 (Big Sur) or later.
- Some Macs running macOS 12 (Monterey) have known issues pairing with Bluetooth MIDI devices. If you are having trouble pairing your device on Monterey, updating to macOS 13 (Ventura) has been known to resolve these issues.

7.4. MIDI

Configure global MIDI settings for your H90. These controls will be enabled regardless of the current Program loaded.



Fig. 7.34 MIDI menu page 1

Channel

Select the MIDI channel (1-16) on which the H90 receives and transmits.

Receive Omni

Turn this on if you'd like the H90 to receive MIDI from all channels simultaneously. This setting overrides the receive channel, but the H90 will still transmit on the configured channel.

Output Mode

- Off: No MIDI information will be transmitted to the MIDI output.
- Transmit: H90 will transmit Program Change, CC, and MIDI Clock information from the DIN MIDI output. MIDI will not be passed thru from the DIN MIDI input.
- Thru: MIDI information from the DIN MIDI input will be sent to the DIN MIDI output. H90 will not transmit MIDI information.

Clock Source

Configure the H90 to use the DIN or USB input as the MIDI clock source. Set Tempo Source to MIDI in the Tempo Menu to sync the H90 to this clock source.

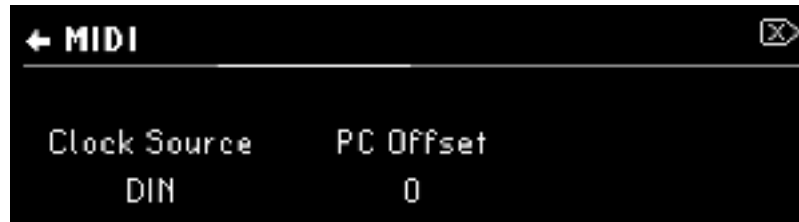

Fig. 7.35 MIDI menu page 2

PC Offset

By default, the H90 will transmit and receive Program Changes using PC numbers 1-100. Enabling a PC Offset on the H90 will make it transmit and receive Programs Changes using PC numbers 0-99. When using other MIDI devices that use PC numbers starting at 0, set PC Offset to 1 so the PC numbers match on all of your devices.

Global Control

MIDI Global Control allows you to define MIDI control messages that will always affect the H90, regardless of which Program is loaded. For example, if you always want CC #5 on your MIDI controller to control Quick Knob 1, you can configure this using the MIDI Global Controls.

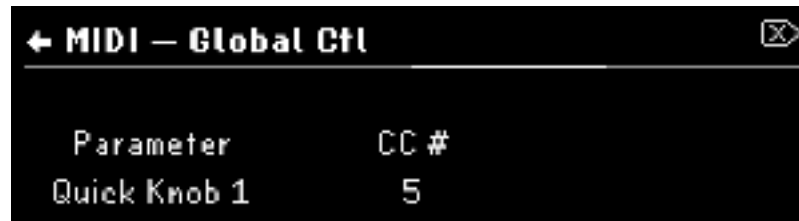

Fig. 7.36 MIDI Global Control

- Parameter: Use Quick Knob 1 to select a parameter.
- CC #: Use Quick Knob 2 to select a CC # to control the currently selected parameter.

Note

Check out the Global Mapping Chart (Section C) for a full list of available mappings.

Transmit

MIDI Transmit allow you to use controllers such as aux switches and expression pedals as MIDI controllers by having the H90 transmit corresponding MIDI CC messages from the DIN MIDI output.



Fig. 7.37 MIDI Transmit

- Parameter: Turn Quick Knob 1 to select a parameter.
- CC #: Turn Quick Knob 2 to select a CC # for the currently selected parameter to transmit as MIDI CCs.

7.5. Preferences

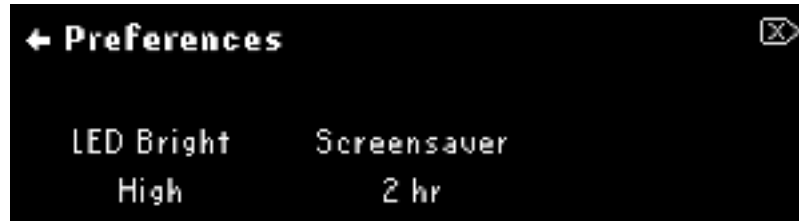

Fig. 7.38 Preferences menu display

LED Bright

Adjust the brightness of the LEDs.

- High
- Med-High
- Low-Med
- Low

Screensaver

Configure the amount of time it takes for the screensaver to be enabled. The screensaver will display an H90 animation, and help preserve the longevity of the H90's OLED screen. Adjustable from 30 minutes to eight hours.

7.6. About

Displays the H90's serial number, as well as version numbers for the audio and software.

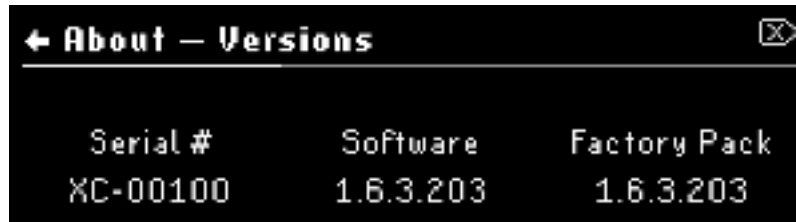

Fig. 7.39 Page 1 of the About menu



Fig. 7.40 Page 2 of the About menu

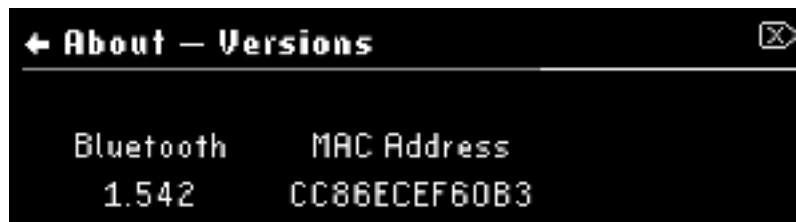

Fig. 7.41 Page 3 of the About menu

8. TEMPO MENU

Press and hold the Presets and Parameters Buttons simultaneously to enter the Tempo Menu. Press the Perform Knob to exit.



Fig. 8.1 Press and hold the Presets and Parameters Buttons simultaneously



Fig. 8.2 The Tempo Menu

Tempo BPM

The H90's internal tempo can be adjusted from 20 BPM to 500 BPM. With Tempo Source set to Global or Program, Tap the P Footswitch or turn Quick Knob 1 to set the adjust the Beats Per Minute.

Tip

If MIDI transmit is turned on, you can sync other MIDI devices to the H90's internal clock via the MIDI DIN output.

Tempo Source

- Global: All Programs will subscribe to the Global Tempo setting.
- Program: Programs will save with the current tempo BPM. Programs will load with the saved BPM value.
- MIDI Clock: Tempo will be synced to MIDI clock from DIN or USB. Go to System Menu > MIDI (Section 7.4) to configure USB or DIN as the MIDI clock source.

Remember!

In Parameters Edit Mode, press the Presets and Parameters Buttons simultaneously to toggle Tempo Sync on/off for a Program or Preset.



Fig. 8.3 A metronome icon will indicate that Tempo Sync has been enabled.

9. SOFTWARE UPDATES

We recommend that you keep your H90's software up to date. All of your updates will be done using the H90 Control application, which will notify you whenever a new update is available.



Fig. 9.1 You will be notified when an update is required. Click the cloud icon to update your H90's software.

To update your H90's software:

- Visit <https://www.eventideaudio.com/my-account/> to register your H90 and download H90 Control.
- Once the installer is downloaded, double-click the installer icon and follow the on-screen installation instructions.
- Power on your H90 and connect it your computer via the supplied USB-C to USB-A cable.
- Open H90 Control, click "Add Device" in the top right corner, and Select "H90 Pedal".

- If your computer is connected to the internet and your H90's software is not up to date, you will be prompted to update your H90.
- Follow the on-screen instructions to update.

Warning

Do not unplug the power supply of your H90 during the update process. The H90's screen will display a connection icon to indicate that the update is in progress.



Fig. 9.2 The H90's connection icon

10. H90 CONTROL

H90 Control is a stand-alone program for:

- macOS computers running 10.13 or higher (Apple Silicon native is supported).
- PCs running Windows 10 or higher.
- iPads running iPadOS 15 or later

Note

The H90 Control user interface is the same on all devices (macOS, PC, iPad.) Certain features will not be available depending on what device you are using.

H90 Control provides remote control access and Program/Preset management for the H90 and dot9 stompboxes. Manage Program and Preset settings, perform system updates, and import/export User Lists with an easy-to-use interface.

10.1. Getting Started

10.1.1. Register and Install

Please visit <https://www.eventideaudio.com/my-account/> to register your H90 or dot9 stompbox to your Eventide account. Once you have registered your device, you will have access to the H90 Control installer. Once the installer is downloaded, double click the installer icon and follow the on-screen instructions.

Tip

When you first open H90 Control you will be need to sign into your Eventide account. Make sure you use your Eventide username, *not* your email address, when signing in to avoid errors. You will remain signed into your Eventide account until you choose to logout.

10.1.2. Connection

H90 Control can connect to your devices in two ways:

1. All devices can connect directly using USB, using the included USB cable.
2. The H90 can connect wirelessly, using Bluetooth. Checkout the Bluetooth section of the user manual for instructions and troubleshooting.

Warning

When connecting to H90 Control, we recommend only using the included USB cable, or USB cables that are compliant with the USB-C specification; using non-compliant cables can cause serious performance issues or damage your device.

10.2. Home Screen

Once you have opened H90 Control and logged into your Eventide account, you will first see the home screen.



Fig. 10.1 The H90 Control home screen.

1. Click the burger icon for the following options:
 - H90 Control settings
 - Logout of your Eventide account
 - View this user guide
 - Open the H90 Control logfile for support purposes
 - Access Recovery Mode updates
 - Update your dot9 in Update Mode
 - View the About info for H90 Control
2. Once you have connected to a device, it will show up in the top bar. You can connect to multiple devices at once and select each device this way. Click the arrow icon to detach the device's tab and view it in a separate window.
3. Click the Add Device button to add your H90 or dot9 and be able to connect to it.
4. Click the Bluetooth icon to begin the Bluetooth pairing process for the H90.
5. Click the X icon to remove a device.

6. Your device information can be seen here. Click “connect” to start editing parameters on your H90 or dot9. You can also view the devices’s serial number, software version, and whether it uses a USB or Bluetooth connection.
7. Click the cloud icon when an update is available for your device.
8. View what version of H90 Control you are using here.

H90 Control connection tips:

- Your H90 will show up as two devices in H90 Control depending on the connection method: USB or Bluetooth. This will be indicated by the connection icon below the device’s image.



Fig. 10.2 The USB Device can be seen on the left, while the Bluetooth device can be seen on the right.

- You cannot update your H90 via Bluetooth; you must use a USB connection to update. Click the cloud icon in the bottom right corner of the USB device to update.
- Do not connect your H90 to multiple devices running H90 Control via Bluetooth and USB simultaneously.

10.3. Edit Menu

The Edit Menu is used to edit and save Programs and Presets.

10.3.1. The Playlist

The Playlist will be available in all of the Edit Menu tabs, as well as the Program Library.

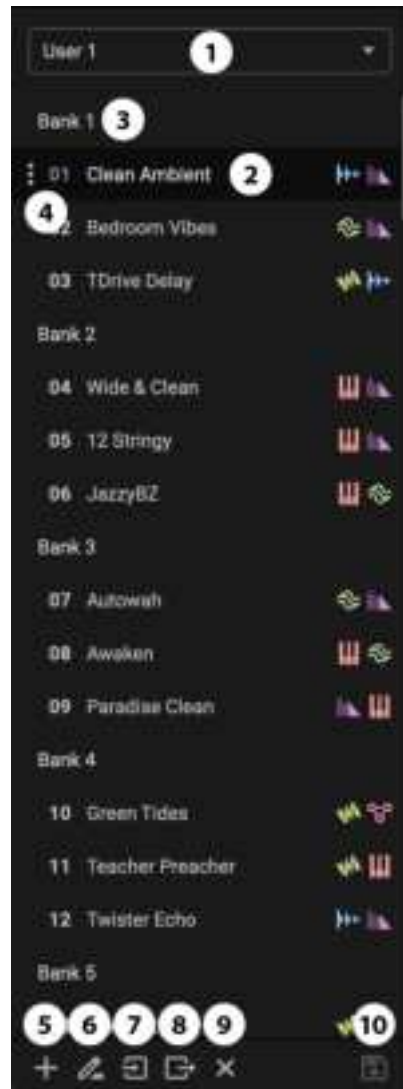

Fig. 10.3 The Playlist.

1. Select a list from the drop down menu.
2. Click any Program to load a Program from the Playlist. You can also navigate the Playlist using the up and down arrow keys, and press Enter to select a Program.

! Unsaved Changes

If your current Program has unsaved changes, you will be prompted to save it before the new Program is loaded.

- Click “Yes” to load the new Program after saving the changes.
- Click “No” to load the new Program without saving the changes.
- Click “Cancel” to stay on the current Program.

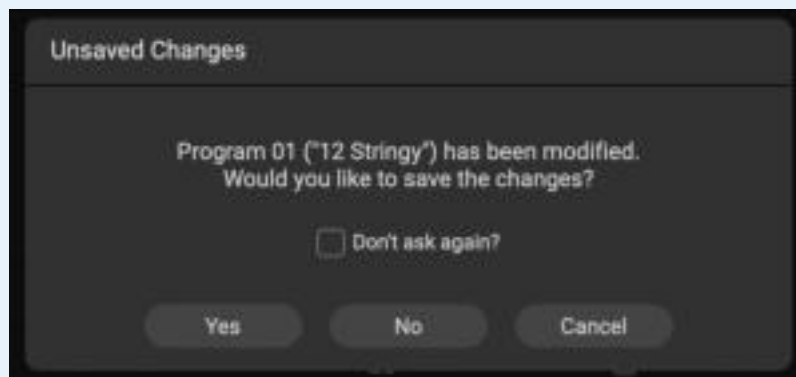

Fig. 10.4 The “12 Stringy” Program changes have not yet been saved.

1. Click a Bank to rename it, press Enter to save the new Bank name.
2. Click the 3-dot icon for the following options:
 - Copy a Program. You can then paste it to a different slot on the Playlist.
 - Delete/Initialize. Erase all settings of the Programs, turning it into a blank slate.
 - Import Program. Load a new Program from a location on your computer.
 - Export Program. Save the Program to a location on your computer.
3. Create a new list. This will automatically become the Playlist.
4. Rename the Playlist.
5. Import List. You can import a Program list created using H90 Control, or an H9 List created using H9 Control.
6. Export List. Save the Playlist to a location on your computer.
7. Delete the Playlist. You will be prompted to make sure you would like to perform this action.
8. Save the current state of the pedal.

10.3.2. Parameters Edit Menu



Fig. 10.5 The parameters edit menu.

1. Click the burger icon for the following options:

- View this user guide.
- Open H90 Control logfile for support purposes.
- Backup Device. This will save a full backup of all the settings on your H90 as a file on your computer.

The following settings will not be saved:

- The current Program and Presets that have not yet been saved to the library.

- The current Playlist selection, and the currently selected Program index within the Playlist.
 - Other states like which Select/Perform mode you are in, Bank/List Select mode, Program/Preset browsing filters, and Bluetooth settings.
- Restore Device. Choose a file from your computer from a previous backup and restore that state. Note that the current state of your pedal and all settings will be overwritten by this backup state.
 - Save H90 logs for support purposes.
2. Undo/Redo certain states of the pedal, such as renaming a Preset/Bank, or loading a preset. This is useful if you load a Preset by accident before saving.
 3. Click the tab to choose to view Edit menu, Program Library, or System Settings.
 4. Disconnect your H90. You will need to reconnect your H90 again from the home page.
 5. Click the heart icon to favorite the Program.
 6. Click the Program's name to rename it. Press Enter to save the new name.
 7. Bypass the Program.
 8. Swap the order of Preset A and B.
 9. View and edit Program notes.
 10. Save the current state of the pedal.
 11. Save the current state of the pedal to a new list location.
 12. Click the 3-dot icon for the following options:
 - View algorithm documentation
 - Copy the preset
 - Paste the preset (if available).
 - Export the preset to a location on your computer.
 - Import a preset from a location on your computer.
 - Save to Library. Save the current state of the preset as a new preset to the Preset Library.
 13. Turn tempo sync on/off for either preset.
 14. Bypass either preset.
 15. Edit Preset specific parameters, such as mix, delay time, etc.

- Edit Preset general parameters, such as the HotKnob, gain levels, tails, and kill dry settings.
- 16.
 17. Edit Program general parameters, such as the HotKnob, gain levels, tails, and kill dry settings.
 18. Select HotSwitch 1-3, and edit parameters for the selected HotSwitch.

📌 Mapping Parameters.

The highlighted ring around the parameter indicates that this parameter is mapped to controller, such as a HotKnob, expression pedal, aux switch, or MIDI CC.

- Click the arrow in the top right corner of the parameter to edit the control source and start/end points.
- You can also edit the start/end points by clicking and dragging the arrow at the ends of the highlighted ring around the parameter.



Fig. 10.6 The Delay Mix parameter is mapped to the Preset's HotKnob.

Save your Changes!

Just like the pedal, you will see an asterisk whenever any parameter is changed next to Program's name indicating unsaved changes.

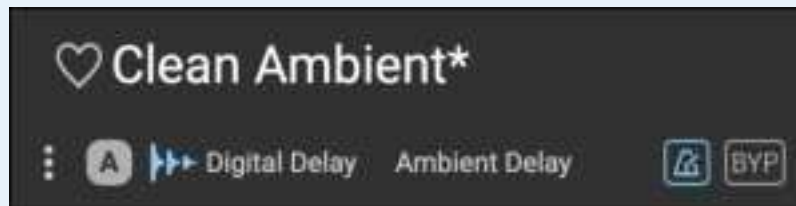

Fig. 10.7 The asterisk indicates unsaved changes. Click the save button in the top right or bottom left corner of the screen to save your changes.

10.3.3. Routing/Inserts



Fig. 10.8 The Routing/Inserts edit menu. Insert 1 is Pre Preset A.

1. Change your routing from Series/Parallel.
2. Determine if you would like two mono inserts or one stereo insert.
3. Adjust the position of the inserts.
4. Adjust the insert parameters. More information can be found in the Insert Routing section of the manual.

10.3.4. Control Assignments

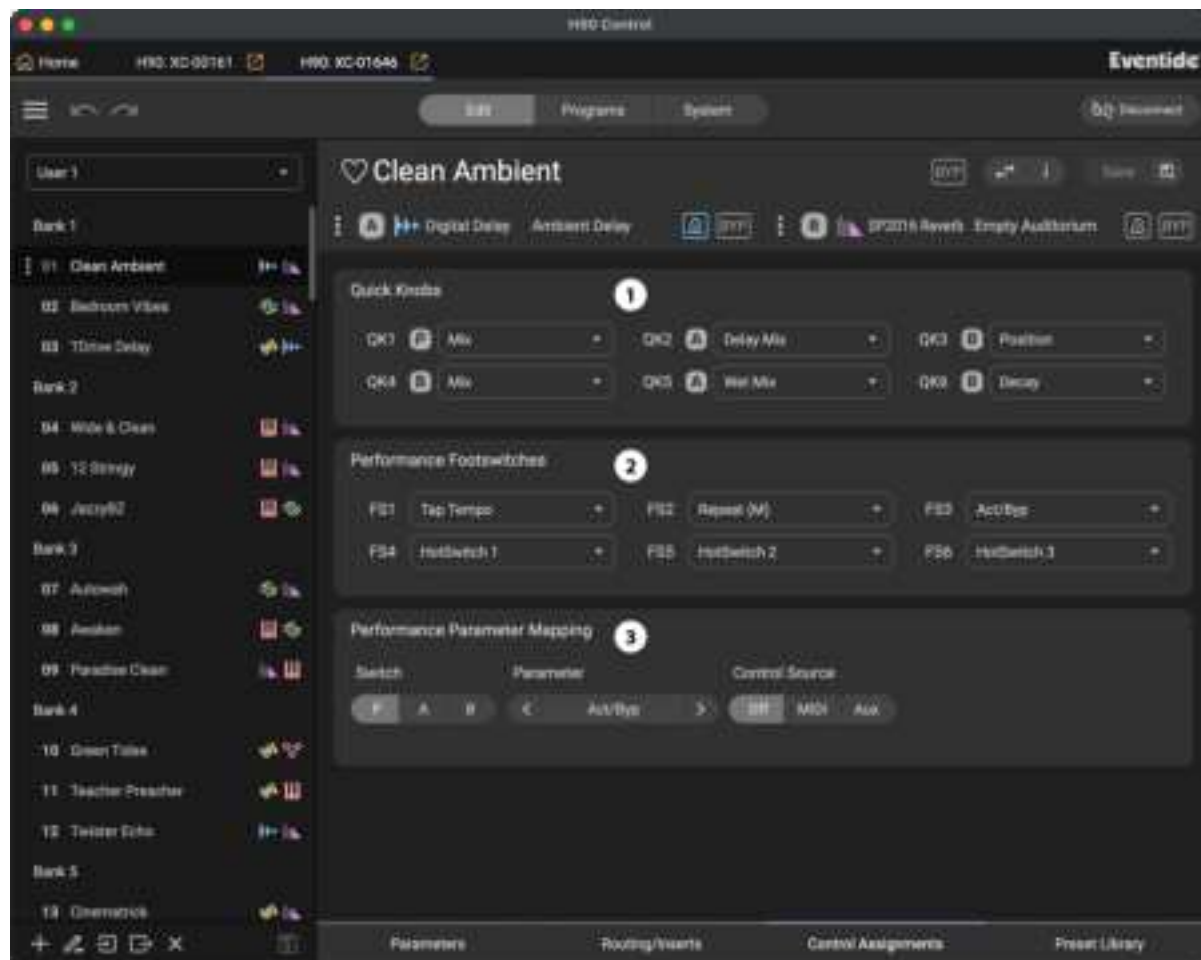

Fig. 10.9 The Controls Assignments edit menu.

1. Assign parameters to the 6 available Quick Knobs.
2. Assign Performance Parameters and HotSwitches to the 6 onboard footswitches.
3. Assign external controllers to the available Performance Parameters.
 - Click the P, A, or B switch to determine which set of parameters you would like to access.
 - Click the parameter drop down menu to select a parameter.
 - Select a MIDI CC or Aux switch as the control source.
4. More information can be found in the Performance Parameters section of the user manual.

10.3.5. Preset Library



Fig. 10.10 The Preset Library.

The Preset Library is used to filter and sort through your saved presets.

1. Click the A or B preset slot to select which preset you would like to replace.
2. Click a preset from the Library to replace the A or B preset.
3. View only User saved presets.
4. View only favorited presets.
5. Hover your mouse to the left of a Preset to expose the heart icon, and click it to favorite a preset.
6. The lock icon indicates a Factory Preset. This cannot be overwritten.
7. Click the arrow to show/hide the search bar.
8. Use the search bar to search for presets by name.
9. Use the *Effect Type* filter to search for all presets of a certain effect type.

10. Use the *Algorithm* filter to search for all presets from a specific Algorithm.

11. Click the 3-dot icon for the following options:

- Copy the preset.
- Export the preset to a location on your computer.
- Import a preset from a location on your computer.

Tip

Note that either the A or B preset will be highlighted to indicate it has been selected. When you select a new preset from the Preset Library, this will replace whichever preset slot is currently highlighted.

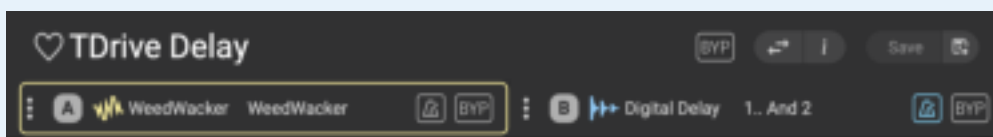

Fig. 10.11 Preset A, Weedwacker, is highlighted in slot A.

10.4. Program Library

The Program Library is where you will manage all of the saved Programs on your H90. It is also used for organizing your Programs into User Lists.

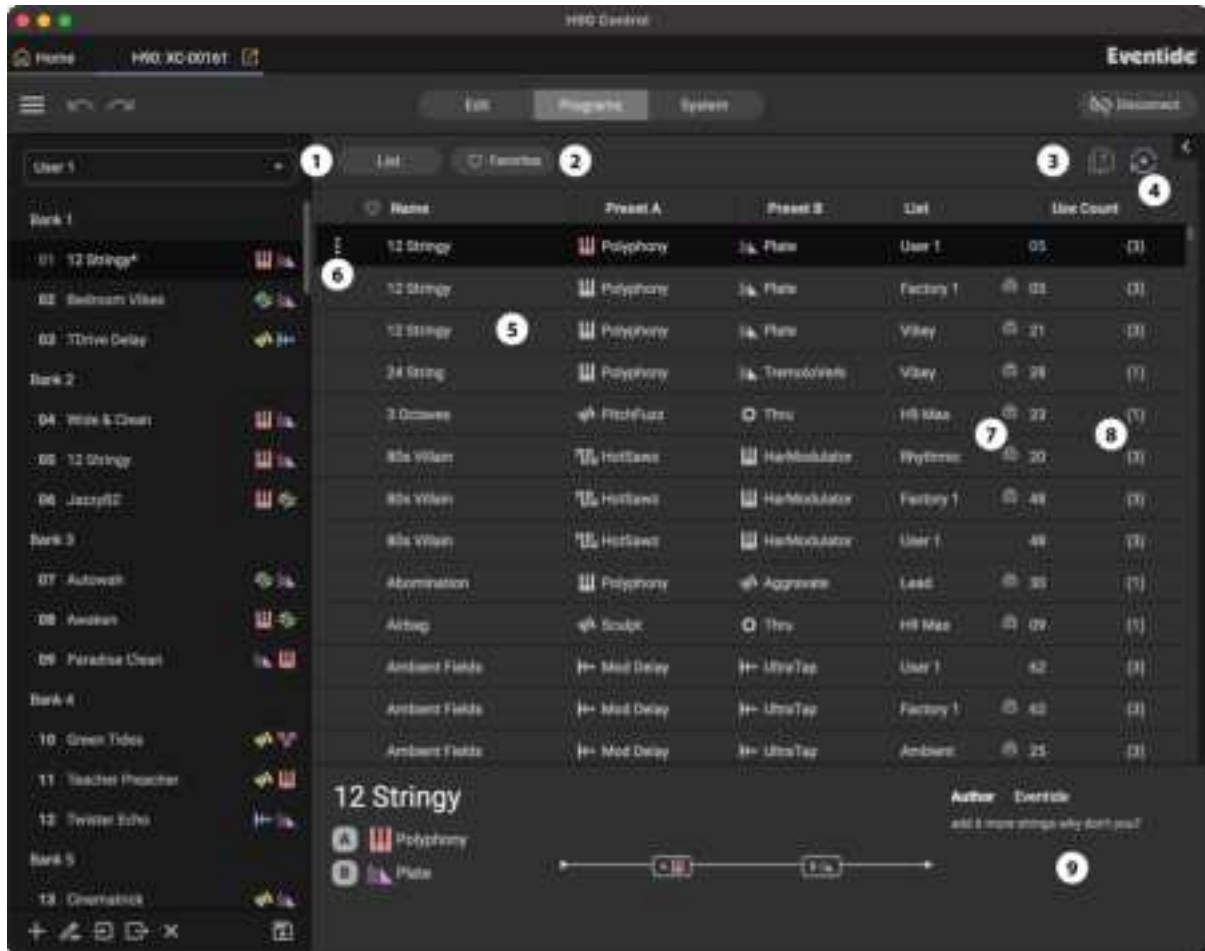

Fig. 10.12 The Program Library.

1. Click here to only show Programs from a specific list.
2. Click here to only show favorited Programs.
3. Hide duplicate Programs that are present on many lists.
4. Program Auto-load:
 - When enabled, Programs will load immediately when selected.
 - When disabled, double-click or press Enter to load a Program.
5. Click anywhere on the Program text to load it, depending on your auto-load setting. Click and drag a Program to a list location on the Playlist to overwrite the Program in that location.
6. Click the 3-dot icon to copy a Program. You may then Paste it to another List location by clicking the 3-dot icon on a one of the 99 Programs from the current Playlist.
7. The lock icon indicates a Factory Program. This cannot be overwritten.
8. The Use Count number displays how many lists the Program is in.

9. Program preview window. When auto-load is disabled, click a Program to view the Presets, Routing, and Program notes before you load it.

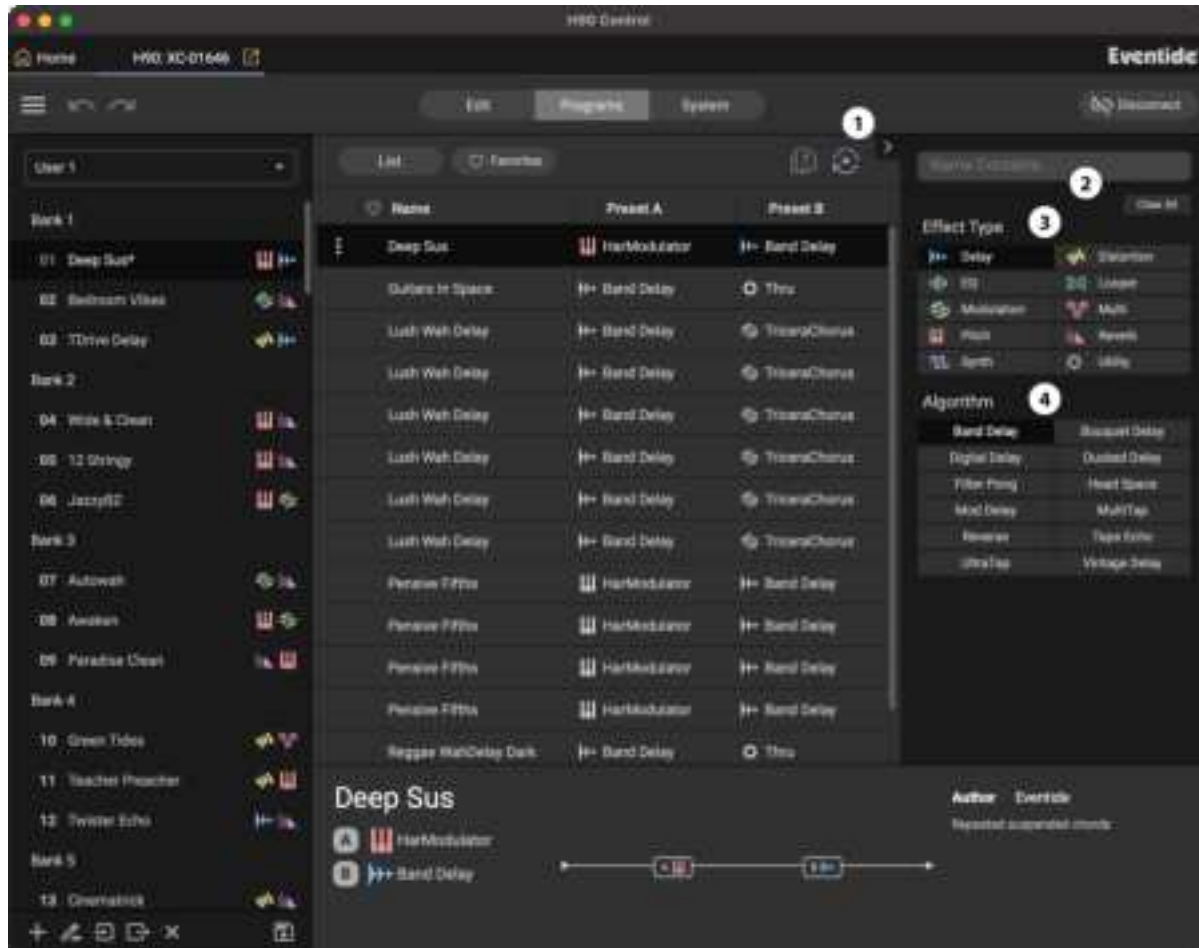

Fig. 10.13 The Program Library with *Delay* and *Band Delay* filters applied. Only Programs that include the *Band Delay* algorithm are shown.

1. Click the arrow to show/hide the search bar.
2. Use the search bar to search for programs by name.
3. Use the *Effect Type* filter to search for all programs that contain a certain effect type.
4. Use the *Algorithm* filter to search for all programs that contain a specific Algorithm.

10.5. System

This menu is where you will adjust the H90's System settings. It also displays your H90's serial number, Routing Mode, and software version.

General Settings

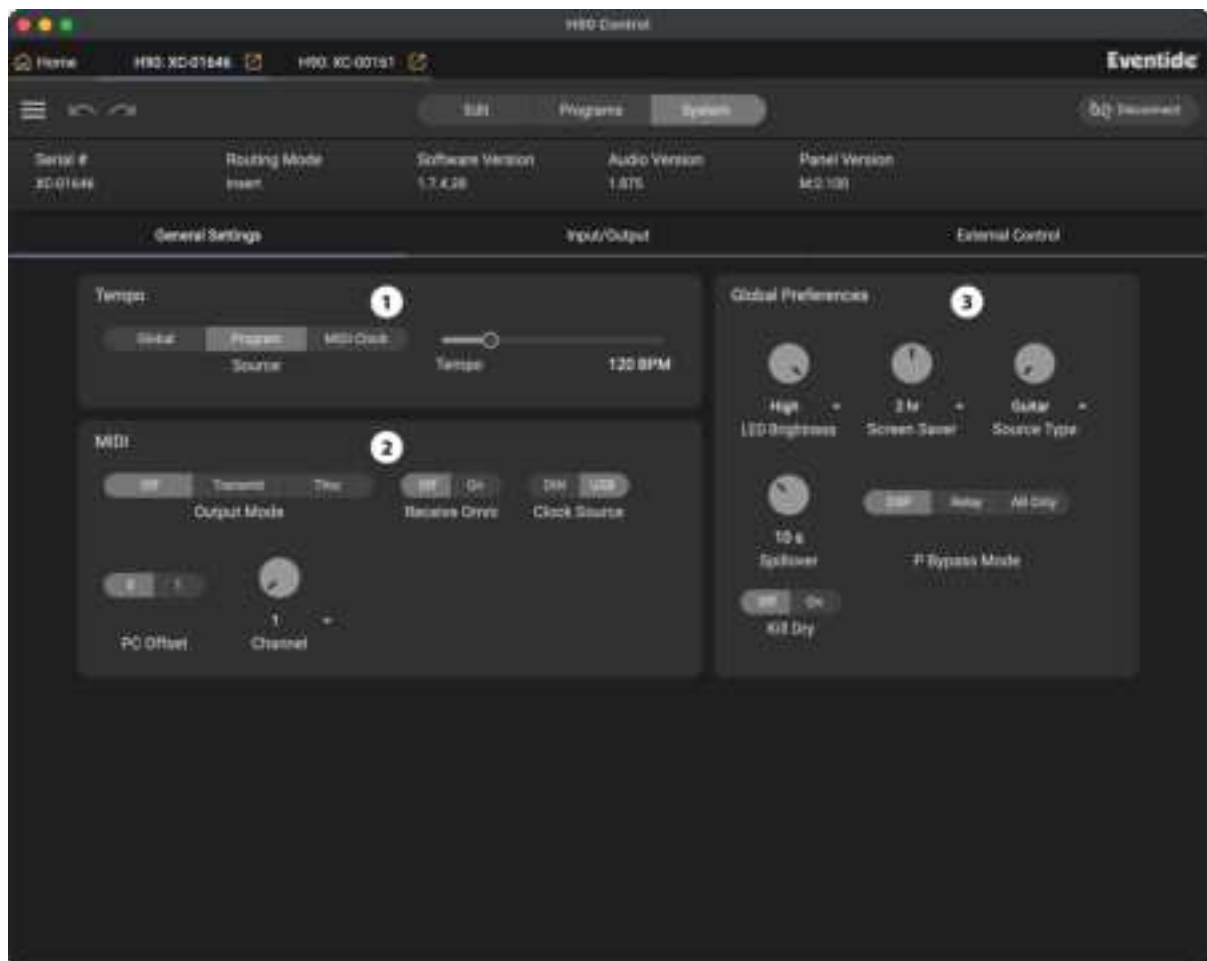

Fig. 10.14 The General Settings menu.

1. Set the Tempo Source or internal tempo BPM.
2. Configure MIDI settings described in the MIDI section of the manual.
3. Set Global Preferences, such as:
 - LED Brightness

- Screen Saver
- Source Type
- Spillover Time
- Program Bypass Mode
- Kill Dry

Input/Output

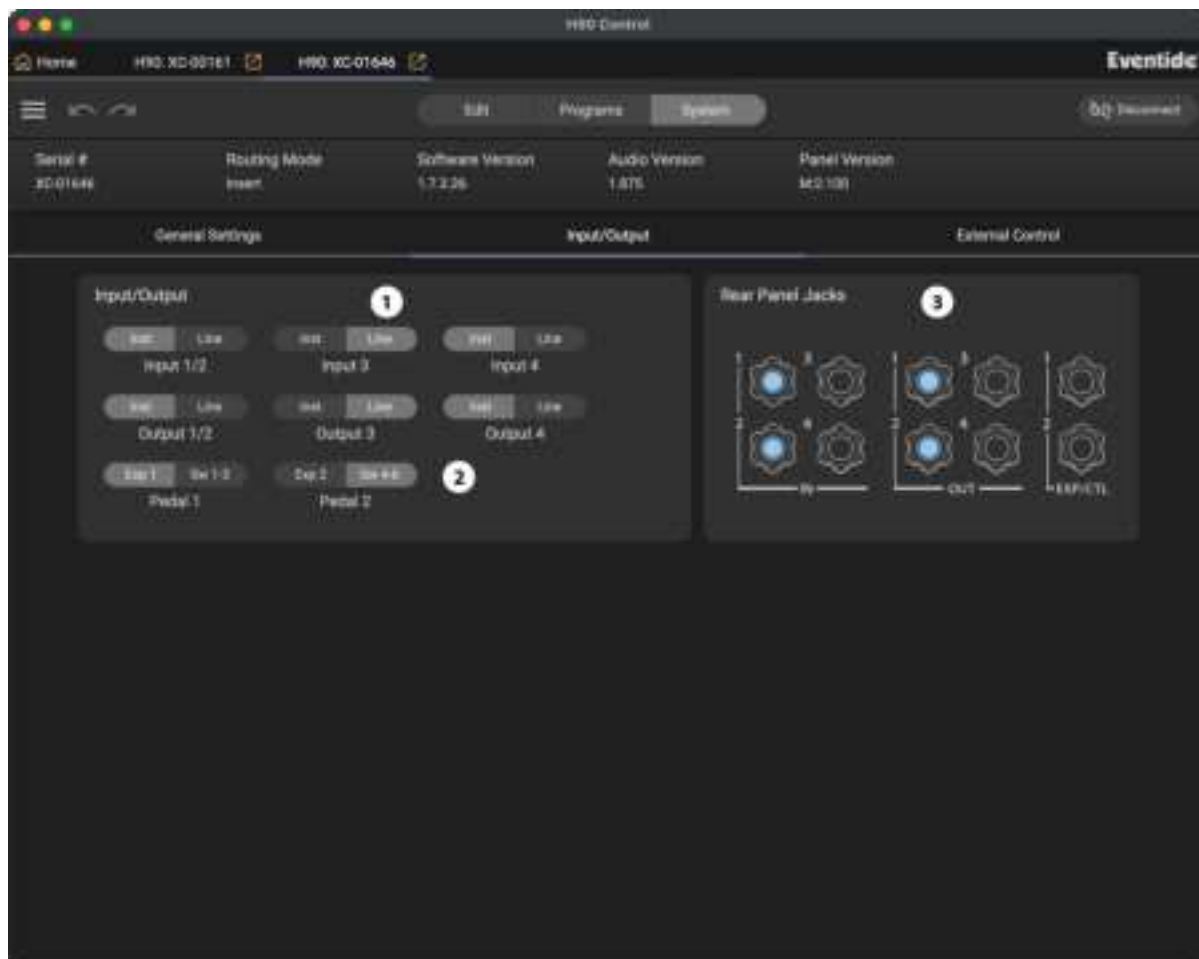

Fig. 10.15 Input/Output Settings menu.

1. Set the input/output levels of the H90 from instrument to line level.
2. Set the exp/ctl inputs to be either an expression pedal or a switch. Note that you must calibrate the connected device using the H90, you cannot calibrate using H90 Control.
3. The Rear Panel Jack icons will be highlighted when a cable is connected to the respective jack.

Global Control

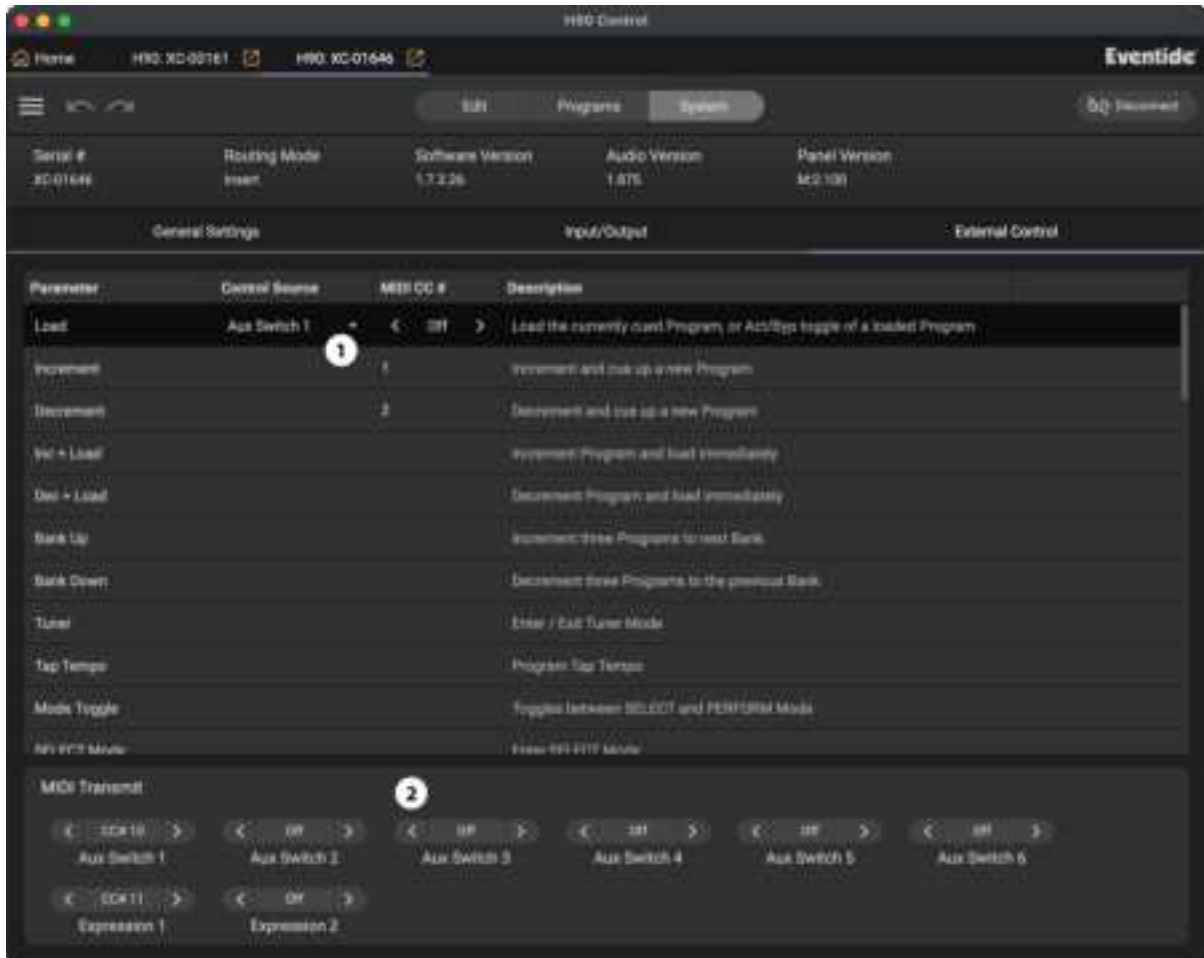

Fig. 10.16 The General Settings menu.

1. Set the Global Pedal Controls to use either footswitches, expression pedals or MIDI CCs. View the Global Mapping Chart for a full list of the available options.
2. Configure your footswitches or expression pedal to transmit MIDI CCs. View the MIDI section of the manual for more information about MIDI transmit.

10.6. Using dot9 Stompboxes

10.6.1. dot9 Edit Menu

The Edit Menu is used for managing your Presets and adjusting the settings of your dot9 stompbox.



Fig. 10.17 The edit page displays the TriceraChorus dot9 parameters.

1. Click the burger icon for the following options:

- Backup Device
- Restore Device
- Factory Reset

2. Click any Preset to load a Preset from the list. You can also navigate the list using the up and down arrow keys, and press Enter to select a Preset.

ⓘ Unsaved Changes

If your current preset has unsaved changes, you will be prompted to save it before the new preset is loaded.

- Click “Yes” to load the new preset after saving the changes.
- Click “No” to load the new preset without saving the changes.
- Click “Cancel” to stay on the current preset.

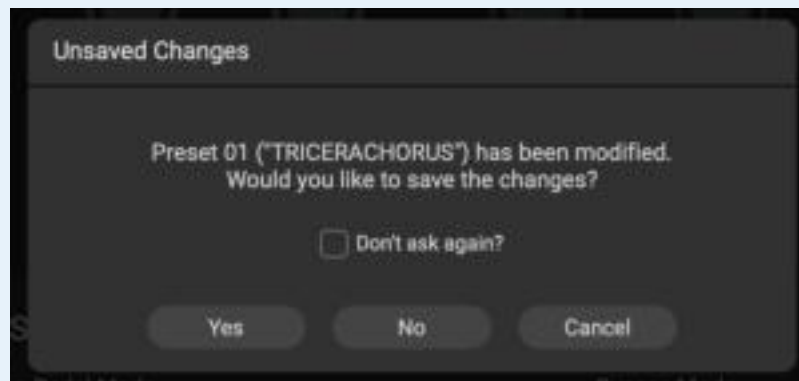

Fig. 10.18 The “TriceraChorus” Preset changes have not yet been saved.

1. Click the preset name to change it.
2. Tap or type in the tempo for the stompbox to follow. This will be disabled if MIDI Clock is on, and it will not be available if the stompbox you are using is not tempo based.
3. Save the current preset settings.
4. Save the current preset to another list location.
5. Adjust the footswitch and LED button parameters.
6. Adjust the main effect parameters. Primary parameters are displayed on the left, Secondary parameters are displayed on the right.
7. Import the selected preset.
8. Export to the selected preset.
9. Delete the selected preset.

! Expression Mapping

Select a parameter and click the drop-down arrow to map it to the expression pedal:



Fig. 10.19 The Detune parameter is mapped to the expression pedal.

10.6.2. dot9 System Settings

1. Expression Pedal Mode

- Exp: Expression Pedal
- Exp + Aux: Tip = Expression Pedal, Aux = Tap Tempo
- Triple Aux: Tip = Increment Preset, Ring = Decrement Preset, Tip+Ring = Load Preset
- MIDI Box: Receive MIDI via a MIDI convertor box
- MIDI TRS: Receive MIDI directly with a DIN or TRS to TRS cable
- OXU: Tip = Decrement Preset, Ring = Increment Preset, Tip+Ring = Load Preset

2. Bypass mode

- Buffer: Keeps signal running through the DSP when bypassed.
- Relay: Directly connects inputs to outputs with physical relay switches.

- DSP+FX: Keeps signal running through the DSP when bypassed and allows delay/reverb bypass tails.
3. Kill Dry: Removes the dry signal from the output. Useful for wet/dry, effects sends, and aux/bus configurations.
 4. Knob Catch Up: With Catch Up ON, the sound does not change until the Knob is moved to the position corresponding to the current value. The LED Ladder indicates whether the knob must be turned CCW (top LED blinks) or CW (bottom LED blinks). The LED flashes more rapidly as the knob approaches the value set by the Preset. All five LEDs blink once when the knob matches the stored Parameter value.
 5. MIDI Clock: Allows your dot9 to receive MIDI clock via the USB or expression pedal input.
 6. MIDI Channel: Set which channel your dot9 receives MIDI messages on. 0-16 or Omni.

This page was intentionally left 99.88% blank.

11. ALGORITHM GUIDE

To get an overview of the wide selection of effects the H90 offers, a stroll through this guide is recommended. You may search Algorithm descriptions by using this manual's search box, but the best way to quickly find the best effect is to make use of the H90's powerful real-time database features by using either the Preset Edit mode or H90 Control.



Fig. 1 Each Effect Type has a signature icon

Delay

Band Delay

Delays are followed by user selectable modulated filters.

- Mix: Wet/dry mixer, 100% is all wet signal.
- Delay Mix: Controls the relative level of Delay A and Delay B. Delay Mix's mixing behavior depends on whether you're using mono or stereo outputs.

For mono output:

- Delay Mix = 0%, output 1 will have only delay A's contribution.
- Delay Mix = 50%, output 1 has an equal amount of delay A and delay B.
- Delay Mix = 100%, output 1 will have only delay B's contribution.

For stereo output:

- Delay Mix = 0%, both outputs will have only delay A's contribution.
- Delay Mix = 50%, delay A goes to output 1 only and delay B goes to output 2 only.
- Delay Mix = 100%, both outputs will have only Delay B's contribution.
- Delay A: Sets delay time from 0 to 3000 ms (milliseconds). With Tempo Sync OFF, delay is displayed in ms. With Tempo Sync ON, delay can be sync'd to the tempo and is displayed as a rhythmic sub-division of the tempo beat value from No Delay to a whole note in common note increments.
- Delay B: Same as A.
- Feedback A: Controls level of Feedback A, the number of repeats.
- Feedback B: Same as A.
- Resonance: Sets the resonance or sharpness of the filter. Varies from 0 (subtle effects) to 10 (dramatic resonance effects).
- Modulation Depth: Sets the amount that the filter cut-off or center frequencies are modulated/shifted.

- Modulation Speed: Sets the modulation rate for the filter center frequencies (0 to 5 Hz).
- Filter: Select filter type – Low Pass, Band Pass or Hi Pass.

Performance Parameters

- Repeat: A momentary or latching parameter that sets the feedback to the highest value.

Factory Presets

- Guitars in Space
- LastFewBricks2
- Phasery Band2
- Time Slips2
- Haw Echoes1
- Over The Rainbow
- Reggae WahDelay Dark
- Time Slips3
- Haw Echoes2
- Phasery Band
- Time Slips1
- Wah Echo1
- Hidden Pillars

Bouquet Delay

Pronounced Bucket. An emulation of analog delay pedals with two different flavors and a couple of modern tricks.

- Mix: wet/dry mixer, 0 to 50 mixes in the delayed signal, 50 to 100 mixes out the dry signal.
- Delay: Delay length control for the Delay mode in milliseconds. Shorter delay lengths brighten the signal delay line output. Both LoFi and Modern modes can make use of the full delay time range, but the hardware that served as the inspiration for LoFi mode was only intended to be used up to 300 ms. Anything above that and you're seriously under-clocking the chip.
- Feedback: Controls the level of feedback in the delay path for both the Short and Long delay modes. Capable of driving the delay into self oscillation close to 10 (not precise due to other settings in the BBD affecting feedback) in Modern mode, and at varying amounts (depending on delay time settings) in LoFi. (75 ms to 1000 ms)
- Mod Depth: Controls the amount of modulation applied to the BBD delay line. Note that modulation amounts will vary depending on the Delay time.
- LFO Rate: Controls the speed/rate of the modulation LFO. (0.01 Hz to 20 Hz)
- LFO Shape: LFO Shape of the modulation oscillator. The choices are:
 - SINE
 - FATSINE
 - TRIANGLE
 - SQUARE

- SAW
- RAMP
- NOISE
- Delay Mode: (Lofi/Modern) Two different options for delay sounds. LoFi emulates an early bucket brigade pedal that was limited to a delay time of 300 ms. Modern will be a little brighter/cleaner sounding and the self-oscillation will be a little more uniform.
- Jump Interval: Controls the ratio used to jump the delay time when using the PitchJump performance parameter. (m3, M3, P4, P5, Oct.)
- Stereo Tap Division: When stereo outputs are connected, a second tap out of the BBD emulation is connected to the second channel. This controls the point at which this second delay is tapped out of the BBD.

Performance Parameters

- Self Osc: A momentary or latching performance parameter that causes the BBD emulation to self-oscillate.
- Pitch Jump: A momentary or latching performance parameter that instantaneously scales the delay time (clock frequency) of the BBD emulation by the ratio determined by the Jump Interval parameter. This causes a momentary pitch shift of any sound being fed back through the BBD emulation.
- Retrigger: Retriggeres the modulation LFO to the beginning of the cycle. Useful for re-syncing during playback, or creative effects.

Factory Presets

- Allium
- Flower Power
- Gimme Some Reggae
- LeakyBucket
- Nice Slap
- Rosebud
- Unintended

Digital Delay

Twin 3 second delays with independent delay time and feedback controls.

- Mix: wet/dry mixer, 100% is all wet signal.
- Delay Mix: Controls the relative level of Delay A and Delay B. Delay Mix's mixing behavior depends on whether you're using mono or stereo outputs.

For mono output:

- Delay Mix = 0%, output 1 will have only delay A's contribution.
- Delay Mix = 50%, output 1 has an equal amount of delay A and delay B.
- Delay Mix = 100%, output 1 will have only delay B's contribution.

For stereo output:

- Delay Mix = 0%, both outputs will have only delay A's contribution.
- Delay Mix = 50%, delay A goes to output 1 only and delay B goes to output 2 only.
- Delay Mix = 100%, both outputs will have only Delay B's contribution.
- Delay A: Sets delay time from 0 to 3000 ms (milliseconds). With Tempo Sync OFF, delay is displayed in ms. With Tempo Sync ON, delay can be sync'd to the tempo and is displayed as a rhythmic sub-division of the tempo beat value from No Delay to a whole note in common note increments.
- Delay B: Same as A.
- Feedback A: Controls level of Feedback A, the number of repeats.
- Feedback B: Same as A.
- X-Fade: When delays change, performs a crossfade function to prevent abrupt changes that could result in glitching or clicking. X-Fade sets the speed of the crossfade. Small values result in rapid crossfades, larger values more gradual crossfades. Crossfade rates vary from 2 ms to 200 ms.
- Modulation Depth: Selects the amount of delay modulation (0 = Off, 10 = Max).
- Modulation Speed: Sets the delay modulation rate (0 - 5 Hz).
- Filter: A low pass/high pass filter variable from -100 (max high pass) to 0 (no filtering) to 100 (max low pass) to change the tone of your delay repeats.

Performance Parameters

- Repeat: A momentary or latching parameter that sets the feedback to the highest value.

Factory Presets

- 1.. And 2
- Ambient Delay
- AnothrBrick1
- Big Nice Day
- Big Warm Digital
- Bridge Of Sighs
- ChorusyTrem
- ComfNumbVerse
- Copy Cat
- DDLY
- Dual Big Warm Digital
- EVPREMIX
- Filtered Digital
- Flaser
- LastFewBricks1
- Pristine Digital Delay
- RunRunRun
- Storm Brewing1
- Storm Brewing2
- Trem Delays
- TwinDelay
- What I'm Looking For

Ducked Delay

The delay levels are dynamically lowered while you're playing and restored to their normal levels when you stop playing.

- Mix: wet/dry mixer, 100% is all wet signal.
- Delay Mix: Controls the relative level of Delay A and Delay B. Delay Mix's mixing behavior depends on whether you're using mono or stereo outputs.

For mono output:

- Delay Mix = 0%, output 1 will have only delay A's contribution.
- Delay Mix = 50%, output 1 has an equal amount of delay A and delay B.
- Delay Mix = 100%, output 1 will have only delay B's contribution.

For stereo output:

- Delay Mix = 0%, both outputs will have only delay A's contribution.
- Delay Mix = 50%, delay A goes to output 1 only and delay B goes to output 2 only.
- Delay Mix = 100%, both outputs will have only Delay B's contribution.
- Delay A: Sets delay time for Delay A output from 0 to 3000 ms (milliseconds). With Tempo Sync OFF, delay is displayed in ms. With Tempo Sync ON, delay can be sync'd to the tempo and is displayed as a rhythmic sub-division of the tempo beat value - changing this from 0 to a whole note in common note increments.
- Delay B: Same as A.
- Feedback A: Controls level of Feedback A, the number of repeats.
- Feedback B: Same as A.

- Ducking Ratio: Sets the ducking ratio or the degree to which the delay is attenuated.
- Threshold: Sets the ducking threshold - the audio amplitude - at which ducking kicks in (-36 dB to -66 dB).
- Release Time: Sets the release time from 500 to 10 ms. With the release time set to short values, the delay will kick in quickly when you stop playing. With the release time set to longer values, the delay will stay ducked for a while. Longer release times are useful when you're playing a riff and don't want the delay to kick in between notes.
- Filter: A low pass/high pass filter variable from -100 (max high pass) to 0 (no filtering) to 100 (max low pass) to change the tone of your delay repeats.

Performance Parameters

- Repeat: A momentary or latching parameter that sets the feedback to the highest value.

Factory Presets

- ComfNumbSolo
- DontLeaveMe
- Country Compressor
- ThinIce
- Country Compressor
- Volume Swell Helper

Filter Pong

The dual delays ping pong between the outputs with filter effects added for good measure.

- Mix: wet/dry mixer, 100% is all wet signal.
- Delay Mix: Controls the relative level of Delay A and Delay B. Delay Mix's mixing behavior depends on whether you're using mono or stereo outputs.

For mono output:

- Delay Mix = 0%, output 1 will have only delay A's contribution.
- Delay Mix = 50%, output 1 has an equal amount of delay A and delay B.
- Delay Mix = 100%, output 1 will have only delay B's contribution.

For stereo output:

- Delay Mix = 0%, both outputs will have only delay A's contribution.
- Delay Mix = 50%, delay A goes to output 1 only and delay B goes to output 2 only.
- Delay Mix = 100%, both outputs will have only Delay B's contribution.
- Delay A: Sets delay time for Delay A output from 0 to 3000 ms. With Tempo Sync OFF, delay is displayed in ms. With Tempo Sync ON, delay can be sync'd to the tempo and is displayed as a rhythmic sub-division of the tempo beat value - changing this from 0 to a whole note in common note increments.
- Delay B: Same as A.
- Feedback A: Controls level of Feedback A, the number of repeats. The FilterPong Effect is created by cross connecting the feedback paths of the twin delays. As a result, only a single feedback control is needed.
- Slur: Controls the diffusion of the repeats. With low diffusion the repeats are discrete. Increasing diffusion slurs the repeats.
- Modulation Wave Shape: Selects the shape of the filter modulation. The options are:
 - Sine
 - Triangle
 - Square
- Modulation Depth: Sets the filters' amount of frequency modulation.
- Modulation Speed: Speed multiplier for filter modulation.
- Filter: Controls the mix of dry/filtered signal input to ping-pong delay.

Performance Parameters

- Repeat: A momentary or latching parameter that sets the feedback to the highest value.

Factory Presets

- GoeyFilterOPong
- Nice Thick Thickener
- Pong Echoes
- Schizo Delay
- Science Museum
- Springy Verb
- WubbaWubbaWub

Head Space

An authentic emulation of classic tape delays from days past; only this time you're in complete control. Adjustable playback heads let you decide just how many you have and where they are in relation to the record head. Wow and Flutter, Drive, Hiss, and Filter controls can change this machine from one that's come fresh from the factory into one that just got dug up from the deepest, dustiest corners of the gear closet while two performance parameters can add some dramatic emphasis to live performances.

- **Mix:** Controls the levels of the dry and wet (tape delayed) signals to the output of the effect. 0 to 5 mixes in the delayed signals. 5 to 10 mixes out the dry signal.
- **Delay Time:** Controls the longest delay length possible of any one Head by changing the tape speed. Use a Head Div of 1 to reach full delay time of any one tap. 200-3000 ms.
- **Speed:** Runs the tape emulation at either Half or Full speed while keeping the overall delay amounts the same. At Full speed the machine ranges from 30 ips to 1.875 ips. At Half the machine ranges from 15 ips to a glacially slow speed of 0.9375 ips.
- **Rec Drive:** Higher levels saturate the tape creating an overdriven sound
- **Feedback:** Master Feedback control for all Heads. Capable of driving the tape delay into self oscillation from around 7 to 10 (not precise due to other settings affecting feedback structure and levels in the feedback loop).
- **Fdbk Path:** Controls which Heads contribute their output to the feedback loop. The options are:
 - 1, 2, 3, or 4
 - 1 & 2
 - 1 & 3
 - 1 & 4
 - 2 & 3
 - 2 & 4
 - 3 & 4
 - 1 & 2 & 3
 - 1 & 2 & 4
 - 1 & 3 & 4
 - 2 & 3 & 4
 - All
- **Wow & Flutter:** Controls the amount of mechanical anomalies of a real tape machine. These anomalies manifest as pitch warbles and delay variations. Use 0 for a perfectly constructed and

maintained high end tape machine. Use 10 for a lower end, old tape machine in need of some serious repair.

- **Tape Hiss:** Controls the amount of tape hiss. 0 is no hiss. 10 is the most amount of hiss. Control is global over all playback heads.
- **Filter:** Equalization control for all Head outputs. The outputs of the EQs are in the feedback loop. -10 to 0 Low cut shelf. 0 to 10 Hi cut filter (low pass).

The following parameters apply to all 4 tape heads:

- **Head Level:** Playback level of each tape head sent to the output of the effect. 0 is OFF. 10 is maximum. Does not control the levels of each feedback loop.
- **Head Div:** Controls where each playback head is located in relation to the record head and the max delay time. In fraction units of the max delay time set by the Delay Time control. This control is continuously adjustable in percentage increments between two divisions. This can be used to have repeats that perfectly in sync, or to space the Heads imprecisely like they would be on an actual unit. The following options all include adjustments of +/- 0 to 50%

- 1/8 • 1/2 • 5/6
- 1/6 • 2/3 • 7/8
- 1/4 • 3/4 • 1
- 1/3

- **Pan:** Individual Panning controls for each Head output. -100 is left panned and 100 is right panned. Panning follows a -3 dB pan law.
- **Boil Time:** Controls the time it takes for the Boil performance parameter to ramp up to its apex. 200 to 10000 ms.
- **Break Time:** Controls the time it takes for the machine to ramp down to its slowest speed when the Breakdown performance parameter is engaged. 200 to 10000 ms.

Performance Parameters

- **Boil:** These reels sure do seem like they're spinning fast. Does anyone smell smoke?
- **Breakdown:** Someone pulled the plug, the servos have decided they're tired of spinning. Either way things really seem to be s l o w i n g d o w ...

Factory Presets

- DeadSpace
- MultiTape Tap
- Warm Slap
- Head Space
- Old Age Deviant
- Whole Lotta Drive
- Heartbreak Vibe
- Shorty Pickin
- Wild Echoes

Mod Delay

Modulated delays – great for creating chorus effects and chorused delays.

- Mix: wet/dry mixer, 100% is all wet signal.
- Delay Mix: Controls the relative level of Delay A and Delay B. Delay Mix's mixing behavior depends on whether you're using mono or stereo outputs.

For mono output:

- Delay Mix = 0%, output 1 will have only delay A's contribution.
- Delay Mix = 50%, output 1 has an equal amount of delay A and delay B.
- Delay Mix = 100%, output 1 will have only delay B's contribution.

For stereo output:

- Delay Mix = 0%, both outputs will have only delay A's contribution.
- Delay Mix = 50%, delay A goes to output 1 only and delay B goes to output 2 only.
- Delay Mix = 100%, both outputs will have only Delay B's contribution.
- Delay A: Sets delay time from 0 to 3000 ms (milliseconds). With Tempo Sync OFF, delay is displayed in ms. With Tempo Sync ON, delay can be sync'd to the tempo and is displayed as a rhythmic sub-division of the tempo beat value from No Delay to a whole note in common note increments.
- Delay B: Same as A.
- Feedback A: Controls level of Feedback A, the number of repeats.
- Feedback B: Same as A.

- Modulation Wave Shape: Selects the modulation wave shape. There are two choices for each wave shape. The single waveforms modulate the two delays in phase and the double waveforms modulate the two delays out of phase.
- Modulation Depth: Selects the amount of delay modulation (0 = Off, 20 = Max).
- Modulation Speed: Sets the delay modulation rate (0 - 5 Hz).
- Filter: A low pass/high cut filter variable from -100 (max low cut) to 0 (no filtering) to 100 (max high cut).

Performance Parameters

- Repeat: A momentary or latching parameter that sets the feedback to the highest value.

Factory Presets

- 1.. And 2 Mod
- Funk Echo
- Pedal Pitch
- ChorusPhase No Delay
- LazyPhasy
- PhaserEcho1
- Creepy
- Lost Lunch
- PhaserEcho2
- Every Lead You Fake

MultiTap

10 delay taps with controls for delay time, diffusion, tap levels, and tap spacing.

- Mix: wet/dry mixer, 100% is all wet signal.
- Delay Mix: Controls the relative level of Delay A and Delay B. Delay Mix's mixing behavior depends on whether you're using mono or stereo outputs.

For mono output:

- Delay Mix = 0%, output 1 will have only delay A's contribution.
- Delay Mix = 50%, output 1 has an equal amount of delay A and delay B.
- Delay Mix = 100%, output 1 will have only delay B's contribution.

For stereo output:

- Delay Mix = 0%, both outputs will have only delay A's contribution.

- Delay Mix = 50%, delay A goes to output 1 only and delay B goes to output 2 only.
- Delay Mix = 100%, both outputs will have only Delay B's contribution.
- Delay A: Sets delay time from 0 to 3000 ms (milliseconds). With Tempo Sync OFF, delay is displayed in ms. With Tempo Sync ON, delay can be sync'd to the tempo and is displayed as a rhythmic sub-division of the tempo beat value from No Delay to a whole note in common note increments.
- Delay B: Same as A.
- Feedback A: Controls level of Feedback A, the number of repeats.
- Feedback B: Same as A.
- Slur: Controls the diffusion of the repeats from discrete to slurred.
- Taper: Sets the relative level (taper) of the taps. With Taper at -10, the 1st tap is the quietest and the last tap loudest. With Taper at 0, all taps are equally loud. With Taper at 10, the 1st tap is loudest and the last tap quietest.
- Spread: Sets the spacing between taps from 0 (spacing increases) to 5 (taps are equally spaced) to 10 (spacing between taps decreases).
- Filter: Tone control that reduces high frequencies to darken the ambient sounds that you create.

Performance Parameters

- Repeat: A momentary or latching parameter that sets the feedback to the highest value.

Factory Presets

- 500 Seater
- Airplane Hanger
- Ambient Multi
- AutoMarch
- Big SwellPad1
- EmptySpace
- Galloper Multi
- Ghost Town
- King's Missile
- Multi Hall
- Multi WetLive
- Strummer
- Strummer2
- Tapomatic
- Tapper
- Worms

Reverse

Reverse audio effects. Audio is broken into segments, are played backwards and spliced. Crossfading at the splice points prevents nasties. X-Fade controls the length of the crossfade. Small values result in fast crossfades adding an audible rhythm to the effect. Larger values result in long crossfades and a smoother reverse sound.

- Mix: wet/dry mixer, 100% is all wet signal.
- Delay Mix: Controls the relative level of Delay A and Delay B. Delay Mix's mixing behavior depends on whether you're using mono or stereo outputs.

For mono output:

- Delay Mix = 0%, output 1 will have only delay A's contribution.
- Delay Mix = 50%, output 1 has an equal amount of delay A and delay B.
- Delay Mix = 100%, output 1 will have only delay B's contribution.

For stereo output:

- Delay Mix = 0%, both outputs will have only delay A's contribution.
- Delay Mix = 50%, delay A goes to output 1 only and delay B goes to output 2 only.
- Delay Mix = 100%, both outputs will have only Delay B's contribution.
- Delay A: Sets delay time for Delay A output. With Tempo Sync OFF, delay is displayed in ms. With Tempo Sync ON, delay can be sync'd to the tempo and is displayed as a rhythmic sub-division of the tempo beat value - changing this from 0 to a whole note in common note increments.
- Delay B: Same as Delay A
- Feedback A: Controls level of Feedback A, the number of repeats.
- Feedback B: Same as Feedback A.
- X-Fade: In Reverse, the audio segments are read backwards and must be spliced. Crossfades occur at the splice point to prevent abrupt changes that could result in glitching or clicking. X-Fade sets the rate of the crossfade. Small values result in fast crossfades and a more audible rhythm for the reverse effect, larger values more gradual crossfades and a smoother reverse sound. Crossfade rate is variable from 2 ms to 200 ms.
- Modulation Depth: Selects the amount of modulation (0 = Off, 10 = Max).

• Modulation Speed: Sets the delay modulation rate (0 - 5 Hz).

- Filter: A low pass/high pass filter variable from -100 (max high pass) to 0 (no filtering) to 100 (max low pass) to change the tone of your delay repeats.

Performance Parameters

- Repeat: A momentary or latching parameter that sets the feedback to the highest value.

Factory Presets

- Backwards All
- Backwards All2
- Backwards Riffs
- Dring Modulator
- Ethereal Echoes
- Inside Out
- Ramp Up Reverse
- Reverse Flutters
- Reverse Flutters2
- Reverse No Crystals
- Reverse Space
- Reverse Space2
- Reverse Space3

Tape Echo

Simulates the hiss, wow and flutter of analog tape delay. The earliest delays were achieved using tape machines - record on one magnetic 'head' and playback a bit later on second magnetic head. Magnetic tape can be driven into its own unique kind of distortion. Tape Echo's saturation control allows you to adjust the amount. The Wow and Flutter controls simulate the effect of the tape transport failing to move the tape at a smooth, constant rate.

- Mix: wet/dry mixer, 100% is all wet signal.
- Delay Mix: Controls the relative level of Delay A and Delay B. Delay Mix's mixing behavior depends on whether you're using mono or stereo outputs.

For mono output:

- Delay Mix = 0%, output 1 will have only delay A's contribution.
- Delay Mix = 50%, output 1 has an equal amount of delay A and delay B.
- Delay Mix = 100%, output 1 will have only delay B's contribution.

For stereo output:

- Delay Mix = 0%, both outputs will have only delay A's contribution.

- Delay Mix = 50%, delay A goes to output 1 only and delay B goes to output 2 only.
- Delay Mix = 100%, both outputs will have only Delay B's contribution.
- Delay A: Sets delay time for Delay A output B from 0 to 3000 ms (milliseconds). With Tempo Sync OFF, delay is displayed in ms. With Tempo Sync ON, delay can be sync'd to the tempo and is displayed as a rhythmic sub-division of the tempo beat value - changing this from 0 to a whole note in common note increments.
- Delay B: Same as Delay A.
- Feedback A: Controls level of Feedback A, the number of repeats.
- Feedback B: Same as Feedback A.
- Saturation: Simulates analog tape saturation. Ranges from '0' (none) to '10' (max) for the warm compression and distortion associated with overdriven tape.
- Tape Wow: Simulates analog tape Wow. Wow is a term used to describe relatively slowly changing pitch and amplitude modulations caused by problems with the motor or tape transport that causes the tape's motion across the head to vary. A well maintained tape recorder should have no audible Wow. Ranges from '0' (none) to '10' (max).
- Tape Flutter: Simulates tape machine Flutter. Like Wow, Flutter is caused when the tape motion across the magnetic heads isn't constant. Flutter is a more rapidly changing variation than Wow. Flutter ranges from 0 (none) to 10 (max).
- Filter: Controls the filter characteristics to simulate tape recorder frequency response. As you increase the filter value, you'll hear a more pronounced tape tone.

Performance Parameters

- Repeat: A momentary or latching parameter that sets the feedback to the highest value.

Factory Presets

- Be Wowed
- Classic Slap
- Echo
- Fibonacci Tape
- FlutterWow
- Lennon Slap
- Multi Slap
- Record Head
- ReelToReel
- Tape For Vocals
- TapeDrone
- Warped Record

UltraTap

UltraTap is a versatile multi-tap delay-line effect capable of a myriad of sounds from rhythmic and glitchy delays, to wacky comb filtering, to huge pad-like volume swells, to unique reverbs, tremolos, and everything in between. It's the perfect tool for creating drum fills, vocal choruses, swelling guitar chords and other evolving effects.

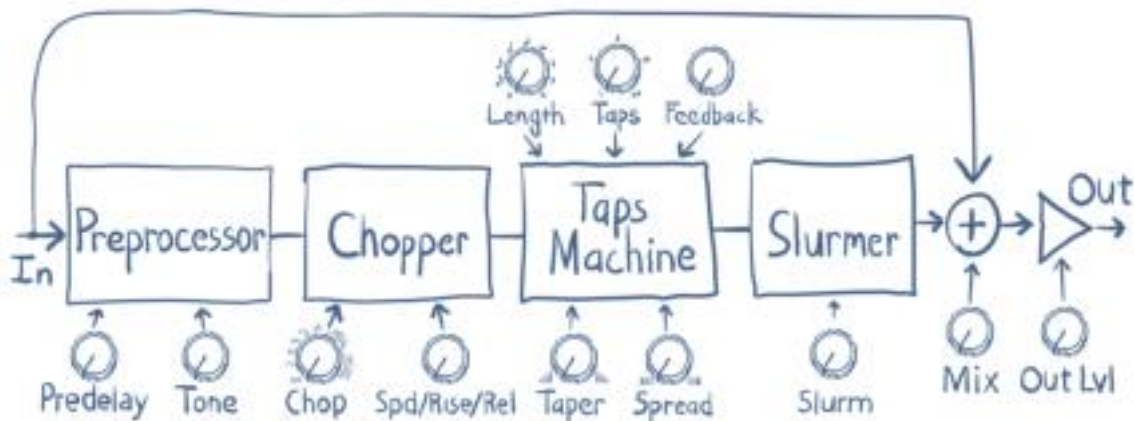

Fig. 2 UltraTap's signal flow diagram

The UltraTap parameters detailed below affect the various signal path blocks shown above. For simplicity only the wet path is diagrammed. Mono In / Mono Out instantiations are center panned with wet output taken off of the left Tap Delay output shown in the diagram.

- **Mix:** Wet/Dry mix, where 100 is an all wet signal. It has a special nonlinear taper which puts most of the knob travel in the most usable range.
- **Length:** Total time over which the Taps are spaced in, up to 10 seconds.
- **Taps:** The number of delay taps, from 1 to 64.
- **Pre-delay:** The amount of time before the first Tap starts, up to 1 second.
- **Spread:** The rhythmic spacing of the taps.
 - Positive values will group more taps towards the end for a “speeding-up” delay sound.
 - Negative values will group taps towards the beginning, for a “slowing-down” feeling.
 - Zero results in constant spacing.
- **Taper:** Controls the fade of the taps.
 - Positive values for a fade-down over the taps.
 - Negative values for fade-up over the taps.
 - Zero will result in equal gain across all taps.

- Feedback: Repeats of a length-valued delay that is fed back around the entire multi-tap machine.
- Tone: A tone control.
 - Positive values for brighter sounding taps.
 - Negative values for darker sounding taps.
- Slurm: Juicy tap slurring/smearing and modulation.
- Chop: A pre-tap-machine “chopping” tremolo OR auto-volume processor. The tremolo has several LFO waveform choices:
 - Off
 - Triangle
 - Sawtooth
 - Ramp
 - Square
 - SampHold: A randomized Sample and Hold.
 - Manual: External control of the pre-tap-machine volume. When selected, the Manual Chop parameter will control the Chop parameter.
 - Swell: Auto-volume processor for volume swells (0-9 input sensitivity control).
 - Trigger: A gating effect that chops off the end of sounds (0-9 input sensitivity control).
- Speed, Rise, or Release: This knob acts as a multi-function parameter control for the Chop knob.
 - For the LFO waveforms, Speed will change the LFO speed.
 - For Swell, Rise will adjust the swell rise time.
 - For Trigger, Release sets the amount of time after triggering before the gate kicks in and chokes off the sound.
- Width: Adjust how the taps are evenly distributed in the stereo field. 0 will result in the no distribution, while positive values will increasingly distribute the taps more, and negative values will reverse this image.

Performance Parameters

- Retrigger: Retrigger the modulation LFO to the beginning of the cycle. Useful for re-syncing during playback, or creative effects.

Factory Presets

- Batman
- Bouncing Ball
- Bullfrog
- Chop Hall
- Clockworks
- Disappearing Hall
- Follow Me
- Ghosthunter
- GlitchTrigger
- Huh Flange
- Mosquito
- Nano Studder
- Six Pulsing
- Slowing Down
- Stutter
- Synth Ghosts
- TapSlap
- UltraSwell
- UltraTap
- ZipperVerb

Vintage Delay

Simulates the sound of analog and digital delays from days gone by. To replicate a range of delay devices from the past, a 'Bits' parameter recreates the effect of primitive analog-to-digital converters. Anyone remember when it was a 10 bit world? The delays can be modulated to achieve chorusing or more extreme effects. A filter parameter controls the tone of the delayed signals.

- Mix: wet/dry mixer, 100% is all wet signal.
- Delay Mix: Controls the relative level of Delay A and Delay B. Delay Mix's mixing behavior depends on whether you're using mono or stereo outputs.

For mono output:

- Delay Mix = 0%, output 1 will have only delay A's contribution.
- Delay Mix = 50%, output 1 has an equal amount of delay A and delay B.
- Delay Mix = 100%, output 1 will have only delay B's contribution.

For stereo output:

- Delay Mix = 0%, both outputs will have only delay A's contribution.
- Delay Mix = 50%, delay A goes to output 1 only and delay B goes to output 2 only.
- Delay Mix = 100%, both outputs will have only Delay B's contribution.
- Delay A: Sets delay time for Delay A from 0 to 3000 ms (milliseconds). With Tempo Sync OFF, delay is displayed in ms. With Tempo Sync ON, delay can be sync'd to the tempo and is displayed as a rhythmic sub-division of the tempo beat value - changing this from 0 to a whole note in common note increments.
- Delay B: Same as Delay A.
- Feedback A: Controls level of Feedback A, the number of repeats.

Feedback B: Same as Feedback A.

-
- Bits: Selects the number of bits of resolution. Early digital delays used analog to digital converters with limited resolution. Theory predicts that each bit equals 6 dB of resolution; so that an 8 bit converter would deliver, at best, a mere 48 dB of dynamic range. Vintage Delay simulates the effects of limited resolution - the sound of nasty digital noise from years gone by.
- Modulation Depth: Selects the amount of delay modulation (0 = Off, 10 = Max).
- Modulation Speed: Sets the delay modulation rate (0 - 5 Hz).
- Filter: Controls the filter to simulate the tone of band-limited old school delays.

Performance Parameters

- Repeat: A momentary or latching parameter that sets the feedback to the highest value.

Factory Presets

- 20 Years Racked
- Ambient Vintage
- Classic Chorus
- FoundIt
- Lo-Rez Trail
- Long Old Delays
- Long Vintage H9
- Long Vintage2
- Nice Old Echoes
- Rotten Old Delay
- SlapVintage
- Streets
- Two Vintage Echoes
- UBetterRun
- Vintage Filtered Echoes
- Vintage Vocal
- Where The Avenues Have No Name

Distortion

Aggravate

Aggravate is an Octave fuzz inspired by famous classic analog octave fuzzes from the 70's. This algorithm will satisfy all your Fuzz needs with its versatile controls, rich feature set and most importantly, its chewy tone that makes playing through it addicting!

- **Mix:** The clean/dirty mix, full left is clean, full right is dirty.
- **Fuzz:** The amount of fuzz.
- **Octave:** Enables or disables the analog-style octave effect
- **Thick:** Makes the fuzz thick (or thicker).
- **Mids:** Midrange control for the stage. -100 to 0 removes midrange for a more scooped sound. 0 to 100 adds midrange.
- **Tone:** -100 to 0 rolls off the treble creating a bassier tone. 0 to 100 brightens the effect.
- **Bias:** Increasing this control will add a "spitty" characteristic to your tone.
- **Filter Env:** Controls the sensitivity of the filter envelope follower. Negative values will start at a high cutoff frequency and move lower as you play; positive values will start at a low cutoff frequency and move higher as you play. At 0 there will be no filtering.
- **Env Shape:** Shape of the envelope filter. Exponential is suggested for guitar, while Linear is suggested for bass.
- **Resonance:** Controls the resonance of the filter.
- **Pump Depth:** Controls the ratio of the pumping compressor. Increasing this will make the pumping effect more pronounced.
- **Pump Control:** Sets what the pump is controlled by. Pump Rate uses the included LFO, manual lets you control the Pump as a performance control.
- **Pump Rate:** Adjusts the speed of the pump rate from .50 - 5 Hz. Higher pump rates work better with shorter release times.
- **Release:** Release time of the pump effect.

Performance Parameters

- **Pump:** Manually triggers the Pump effect. Only works when Pump Control is set to Manual.
- **Retrig:** Retrigger the LFO of Pump Rate.

CrushStation

An overdrive/distortion command center with controls that drive your tone from creamy saturation to brutal sonic assault with everything in between. Use Eventide Harmonizer technology to crush some octaves into the mix, or turn up the Sag to bring the whole sound to its knees. An added bonus, CrushStation is a true stereo distortion.

- **Mix:** The clean/dirty mix, full left is clean, full right is dirty.
- **Drive:** The overdrive amount. Ranges from subtle boost/overdrive to full on distortion with Grit and Sustain controls pushing it into fuzz territory.
- **Compressor/Sustainer:** Compression/Sustain which is Pre distortion (counterclockwise), or Post distortion (clockwise). The sustainer is specially designed to vary the numerous parameters of a typical compressor such as the ratio, attack, release, and the makeup gain to keep the overall loudness consistent.
- **Sag:** Turn it up to get increasingly sputtery, crushed, and broken sounds. Inspired by power rail sag of poorly designed tube amps and the dead and dying gear of times past.
- **Octaves:** Mixes in/out lower and higher pitch-shifted octaves before the distortion and compression.
- **Grit:** Adds more low end before the distortion for a gritty chugging sound.
- **Bass:** Cut and boost lower frequencies to hollow out the sound or add some thud.
- **Mids:** Cut and boost mid range frequencies (frequency selectable with Mids Frequency control) to scoop some muddiness or punch through a mix.
- **Mids Frequency:** Tunable center frequency of the Mids cut/boost. Similar to a parked wah when boosted up high. Smoothly changes when connected to an expression pedal.
- **Treble:** Cut and Boost higher frequencies to mellow out the sound or emphasize higher harmonics.

Factory Presets

- Bass Crush
- Bisque
- Bottom Feeder
- Crowdaddy
- Decapod Muff
- Fra Diavolo
- Fuzz Condition
- Jumbo Shrimp
- Metal
- Power Crush
- PunkRock Lobster
- Sag Harbor
- Scuttle Butter
- Steamed in Beer

PitchFuzz

PitchFuzz is a multi-effects Algorithm combining Fuzz, three Pitch Shifters, and two Delays into one, easy to use effect. Fuzz is the first effect in the signal path, getting its inspiration from classic analog fuzz pedals as well as Eventide's own CrushStation and Sculpt Algorithms. The Pitch Shifters are next in the signal path and are based on Eventide's PitchFlex Algorithm from the PitchFactor pedal. The Delay section is last in the signal path and its lineage can be traced back to the Vintage Delay Algorithm in TimeFactor. The two Delays can be added to the entire output signal following the Pitch Shifters or added individually to two of the pitched voices only, creating arpeggiated type effects.

- **Fuzz:** Controls the amount of Fuzz/Distortion generated after the input signal. A setting of 0 completely bypasses the Fuzz effect. Use 1 to 50 for a distortion type effect and 51 to 100 for more of a Fuzz type effect.
- **Fuzz Tone:** Tone shaper for the fuzz effect.
- **Pitch Amount:** Controls the level of the three Pitch Shifters. From 0 to 3 Voices. Pitch A: 0 to 1.0, Pitch A + B: 1.0 to 2.0, Pitch A + B + C: 2.0 to 3.0.
- **Pitch A:** Adjust the pitch shift amount of the A voice. Range is +/- 2 octaves with micro pitch shift ability at unison (+/- 25c).
- **Pitch B:** Same as Pitch A.
- **Pitch C:** Same as Pitch A.
- **Delay Level:** Controls the amount of both Delays in the signal path as well as two types of Delay routings (Group Delay and Arp Delay). Starting fully counter-clockwise, Group Delay sends the whole signal including all of the Pitched Voices to both delays. Turning past center activates Arpeggiated Delay Mode. In this mode, only voices B and C are fed to the delays (separately and respectively) allowing the creation of arpeggiated effects. Try this with Pitch Amount set to 3.0.
- **Delay A:** Sets the Delay time for Delay A from 0 to 2500 ms when Tempo Sync is OFF. With Tempo Sync ON, Delay is adjusted in note division increments from No Delay to a Whole Note in the most common note divisions.
- **Delay B:** Same as Delay A.
- **Feedback:** Adjusts the amount of feedback for both delays and contains two feedback types (F1 and F2). F1 links both delay times to create a rhythmic, repeating pattern where the longer delay sets the pattern length. The shorter delay will not repeat again until the longer delay has passed. F2 is a traditional feedback control, where delay times are independent.

Factory Presets

- 3 Octaves
- Arpeggiate
- Atmospheres
- Big Bass Synth
- Boogie Oogie Bass
- Cherub
- Chorus and Delay
- Cobbler Triads
- Copeland
- Delicate Trinkets
- Dovers Peach
- Fripper Fuzz
- Fruit In The Rain
- FuzzStack
- FuzzyMass
- Goof Delays
- Harp Chords
- Hot McAdam
- Juiced Up Bass
- Just the Fuzz
- LawfulKnowledge
- Lethal Weapon 7
- Mima Lead
- Muscle
- OhYouAteOneToo
- Organizer
- Peach Dog
- Peach Slap
- Peach-Tavia
- Peaches KICK IT
- Pitch Busters
- R U Fuzz
- Schnapps
- Space Peach
- Suspended Peach
- Weird Orchestra
- WholeLottaPeach
- Working Man Bass

Sculpt

Multi-band Distortion w/ Envelope Follower Control Filters. Carve out your own sound with a dynamic variable blend of hi and lo band distortion channels. Follows your playing style and compliments you with the perfect expression of tunable peaking filters. Perfect for single or dual amp setups!

- Mix: The clean/dirty mix, all the way left is clean, all the way right is dirty.
- Band Mix: The mix between the low and high band.
- Crossover Frequency: The crossover frequency where the low band and high band are split.
- Low Drive: Overdrive of the low band.
- High Drive: Overdrive of the high band.
- Compressor: Pre distortion (counter-clockwise), or Post distortion (clockwise). Turn counter-clockwise to juice up the harmonics in the distortion, or turn clockwise for some sparkly compressor spank. The Sculpt compressor is specially designed to vary the numerous parameters of a typical compressor such as the ratio, attack, release and the makeup gain to keep the overall loudness consistent.
- Low Boost: Boosts the low end either Pre distortion (counter-clockwise) for chuggier low end, or Post distortion (clockwise) for smoother low end.
- Filter-Pre: Peaking filter Pre distortion. Turning left sweeps a cutting filter up in frequency. Turning right sweeps a boosting filter up in frequency, similar to having a parked wah before the distortion. Smoothly changes when connected to an expression pedal.
- Filter-Post: Peaking filter Post distortion. Turning left sweeps a cutting filter up in frequency. Turning right sweeps a boosting filter up in frequency, similar to having a parked wah after the distortion. Smoothly changes when connected to an expression pedal.

- **Envelope Follower:** Envelope follower that modulates both Filter-Pre and Filter-Post according to this input sensitivity setting. The values of Filter-Pre and Filter-Post become the depths that the envelope glides up to. Interesting dynamic changes are achieved when pre and post are set to opposite sweeps, e.g. Pre boost, and Post cut, etc.
- **Stereo Mode:**
 - Split features unique spectral panning effects that spread the hi and lo bands out into the separate channels.
 - Dual Mono outputs the same signal to both outputs channels.

Factory Presets

- Airbag
- AntiWah
- Butter Churner
- Captain Crunch
- Chisel
- Dirt Boost
- Dissect
- Embwahss
- Funke Biass
- Fuzzy Pillow
- Honki Tonki
- Jazzy Box
- Land O Lakes
- Little Speaker
- Meow Wow
- MuthaShip Connect
- Rumble Down Lo
- Sculpt
- Sculpt Da Bass
- UFO Shred
- Wahcraft
- Wahvolver
- Wizards Tele

WeedWacker

Two stage, serial overdrive (distortion) effect. Both stages are identical. Each stage is reminiscent of a famous green overdrive used by your favorite blues/rock players of yore.

- **Mix:** Global mix level of the entire WeedWacker effect.
- **Gate Threshold:** Adjusts the noise gate threshold for the entire effect. -90 dB is off.
- **Stage 2:** Activates or bypasses the 2nd overdrive stage.

The following parameters are available for both Stage 1 and 2:

- **Drive:** Sets the distortion level of the overdrive stage. 0 is cleanest. 100 is dirtiest.
- **Tone:** Tone control for the stage. -100 to 0 rolls off the treble creating a bassier tone. 0 to 100 brightens the effect.
- **Mids:** Midrange control for the stage. -100 to 0 removes midrange for a more scooped sound. 0 to 100 adds midrange.
- **Level:** Final output level control for the stage.

Factory Presets

- Bass Overdrive
- Bass Overdrive
- Bass Overdrive 2
- Hairy Distortion
- Light n Bright
- Slap Drive
- Slasher
- Stank Drive
- Tight Drive
- WeedWacker



EQ Compressor

The EQ Compressor Algorithm is a multi-featured parametric equalizer coupled with a dynamic, intuitive compressor, offering a premium tone shaping tool for a variety of instrumentation. The EQ section includes two completely parametric bands along with low shelf and high shelf filters for easy manipulation of your tone. The unique compressor section can be placed before or after the EQ for maximum flexibility with a single control, enabling you to emphasize, harness, and control the parts of your sound you want to shine through a mix. EQ Compressor also features up to 12 dB of boost at the output to push an amp to awesomeness for your soul tearing solos.

- **Gain 1:** The gain of the first parametric filter. Provides 12 dB of boost or 18 dB of attenuation.
- **Frequency 1:** The center frequency of the first parametric filter. The frequency ranges from 30 Hz to 1500 Hz.
- **Width 1:** Controls the bandwidth of the 1st parametric filter. A value of 10 represents a larger bandwidth while a value of 1 represents a narrower bandwidth.
- **Gain 2:** The gain for the 2nd parametric filter. Provides 12 dB of boost or 18 dB of attenuation.
- **Frequency 2:** The center frequency of the first parametric band. The frequency ranges from 1000 Hz to 9999 Hz.
- **Width 2:** Controls the bandwidth of the 2nd parametric filter. A value of 10 represents a larger bandwidth while a value of 1 represents a narrower bandwidth.
- **Bass:** Controls the gain on the Low Frequency Shelving Filter which is centered around 400 Hz with a slope of 8 dB/Octave. You can boost the lows by 12 dB or cut by 18 dB.
- **Treble:** The gain on the High Frequency Shelving Filter which is centered around 1800 Hz with a slope of 8 dB/Octave. You can boost the highs by 12 dB or cut by 18 dB.
- **Compressor:** The amount of compression applied to the signal. The values to the left half of the knob will affect the Pre-EQ compression, increasing the amount of compression as you move it counterclockwise. The values to the right half of the knob will affect the Post-EQ compression, increasing the amount of compression as you move it clockwise. The compressor is specially designed to vary the numerous parameters of a typical compressor such as the ratio, attack, release and the makeup gain to keep the overall loudness consistent.
- **Trim:** Controls the level at the output of the signal path. Provides 12 dB of boost or 12 dB of attenuation. The Algorithm is designed to “gracefully” clip if there is too much gain inside the EQ.

Factory Presets

- AcousticElec
- Balls
- Basonex
- BassPre2
- BassPre3
- BassPre4
- BassyBass
- Bootyshaker
- Bright
- DiscoGuit
- DubBass
- Flat EQ
- FunkGuit
- Fuzz Conditioning
- JCM to Metal
- JazGuitar
- Leo to Les
- Les to Leo
- Mountain1
- ParkedWah
- PaulsBass1
- PaulsBass2
- SM58Enhancer
- SlapBass1
- SlapBass2
- Sweet Home
- SweetVocal
- Telephony
- VocalPresence
- Walkingbass
- Walkingbass 2

Looper

60 seconds of stereo recording at full audio quality and up to 480 seconds at reduced audio quality. Salient features: record in seconds or beats, variable speed scrubbing during playback and dubbing (including reverse playback and dubbing), seamless dubbing, real-time adjustment of the loop starting point and loop length, full featured MIDI Clock sync, and the all-new 1-Button Looper.

- Mix: Mix control between the Dry audio input and Looper playback.
- Loop Max-Length:

When the Loop is Empty, sets the Maximum allowed Loop Length. Note that audio recording quality is degraded at slower recording speeds (1/2x and 1/4x). The maximum loop length is determined by the setting of the Rec Speed parameter as follows:

- 60 sec at 2x
- 120 sec at 1x
- 240 sec at 1/2x
- 480 sec at 1/4x

When the Loop contains audio, the Max-Length parameter cannot be adjusted.

Note

With Tempo Mode On, the range of the Max-Length parameter depends on the H90's Tempo BPM value. Lower BPM values will not fill up the entire parameter range.

- Loop Play-Start Point: When a Loop is in memory, this sets the Loop Start Point from 0 ms (or beat 1 for Tempo Sync ON) to Loop Length. Loop Play-Start Point defaults to 0 (or beat 1 for Tempo Sync ON) at the beginning of a new loop. When the Loop is Empty, this parameter is disabled.
- Loop Play-Length:

When a Loop is in memory, this sets the Loop Play-Length for playback that begins at the Loop Start Point. In other words, if a 12 second Loop is recorded and the Loop Start Point is set to 2 seconds and the Loop Length is set to 4 seconds, the recorded Loop will play from 2 seconds to 6 seconds into the 12 second Loop. The Play-Length value is automatically reduced in cases where the Play-Start Point moves past the currently set Play-Length.

The Loop Play-Length defaults to Loop Length at the beginning of new loop. Note that Catchup is always enabled to prevent the end point from changing abruptly. When the Loop is Empty this parameter is disabled.

- **Loop Decay Rate:** When dubbing you may want the original saved audio to persist as you add new sounds. Of course, indefinitely adding new signals will eventually result in 'mud' (the "Crayola" effect). The Decay Rate control allows the saved audio to fade as you dub new material. The Decay Rate is adjustable from 0% [DCY: 0] to 100% [DCY:100]. When set to 0%, the loop never decays. When set to 100% the previously saved audio decays completely each time through the loop when dubbing. In other words, the looped audio is only played once. The Loop Decay Rate control has no effect on normal Playback, only dubbing.
- **Dubbing Mode:**

The Dubbing Mode choices are:

- **Latch:** **RECORD** toggles Dubbing ON/OFF. Dubbed audio is added to the looped audio.
- **Punch:** **RECORD** enables Dubbing while the switch is held. Dubbed audio is added to the looped audio.
- **Repl-Latch:** **RECORD** toggles Dubbing ON/OFF. Dubbed audio replaces looped audio.
- **Repl-Punch:** **RECORD** enables Dubbing while the switch is held. Dubbed audio replaces looped audio.

Note

Punch and Repl-Punch are not available when using the 1-button looper. Use the dedicated looper transport controls instead.

- **Playmode:**

Playmode affects three actions of the Looper: the action when Recording reaches Max-Length, the action when Playing reaches the Play-Length, and the action of the **PLAY** switch.

- **Once:** Enters Stopped state when recording reaches Max-Length. During Playback, the audio will Stop when it reaches Play-Length, **PLAY** at any point initiates playing the loop just one time from the loop's start point.
 - **Loop:** Enters Stopped state when recording reaches Max-Length. During Playback, the audio loops around to the loop's start point when it reaches Play-Length, and **PLAY** at any point initiates playing continuously from the loop's start point.
 - **Autoplay:** When recording reaches the Max-Length, loop begins playing automatically and plays continuously. During Playback, the audio loops around to loop's start point when it reaches Play-Length, and **PLAY** at any point will initiates playing continuously from the loop's start point.
 - **Rev-Direction:** When recording reaches the Max-Length, loop begins playing automatically and plays continuously. During Playback, the audio loops around to loop's start point when it reaches Play-Length, and **PLAY** at any point can then be used to toggle the playback direction.
- **Resolution:**

When set to Smooth, resolution is 1%. The other Depth control settings allow you to select the Play Speed in musical intervals as follows (a negative value corresponds to Reverse Play, and all resolutions have 0% in the middle for a full Pause):

- **Octaves:** From three octaves down to one octave up - (+/-) 12.5%, 25%, 50%, 100%, 200%
 - **Octave+5th:** Octaves and fifths - (+/-) 12.5%, 25%, 37%, 50%, 75%, 100%, 150%, 200%
 - **Dom7th:** Dominant 7th Chord (root, M3rd, 5th, m7th, representing common key modulations) - (+/-) 12.5%, 25%, 32%, 37%, 45%, 50%, 63%, 75%, 89%, 100%, 126%, 150%, 178%, 200%
 - **Chromatic:** Semi tones - (+/-) 12.5%, 25%, 26%, 28%, 30%, 32%, 33%, 35%, 37%, 40%, 42%, 45%, 47%, 50%, 53%, 56%, 59%, 63%, 67%, 71%, 75%, 79%, 84%, 89%, 94%, 100%, 106%, 112%, 119%, 126%, 133%, 140%, 150%, 159%, 168%, 178%, 189%, 200%
- **Record Speed:**
- Determines the speed at which the initial loop is recorded. Slower speeds allow for longer loop lengths but at a lower fidelity.
- 2x - Double
 - 1x - Normal
 - 1/2x - Half
 - 1/4x - Quarter
- **Play Speed:**

Determines the playback speed of the loop. Play Speed resolution is dependent on the setting of the Resolution control.

A negative speed with Empty causes playback to automatically start in the Reverse direction after the loop is closed, either through a **PLAY** button press or the Loop and Autoplay settings on the Playmode knob.

After a loop is recorded, Play Speed controls the speed of Loop playback AND dubbing over the full range of speeds allowing for continuous real-time scrubbing from one octave up in Reverse Play (-200%), to one octave up in Forward Play (200%), with a pause (0%) directly in the middle (knob set to 12 o'clock).

- **Filter:** Controls the tone of the looped audio. Tone control filters are placed at both the input and output of the Looper. This allows you to control the tone of the audio that you're recording and then independently control the tone on playback. Turn to the left to cut low frequencies and to the right to cut high frequencies. For flat response, set the knob to 12 o'clock.

Tempo sync

Tempo sync allows beat-based recording and playback that stays in sync with your H90's internal clock or with an external MIDI clock.

Note

Some devices may stop/start transmitting clock depending on the playback state. For example, a DAW or drum machine may not send clock information when the sequencer is not playing. The MIDI clock source for the H90 must be a device that always sends clock information. Consult your devices documentation to determine its MIDI behavior.

When using Tempo Sync with an external MIDI clock source, the Looper will respond to MIDI Start and Stop commands. These commands are sent by many Drum Machines, Sequencers and DAWs when used as the MIDI clock source. However, you'll need to reference your own device or software manual for specific MIDI clock settings and Start/Stop command setup guidance.

The Looper responds to MIDI Start and Stop commands as follows for each Looper State:

Empty:

- MIDI Start: Resets the Looper's internal "beat counter" and causes a Record Footswitch press to sync up to the next beat (See the section on Footswitch Quantization below for more info on this).
- MIDI Stop: No action.

Recording:

- MIDI Start: Stops Recording and starts Loop Playback.
- MIDI Stop: Stops Recording and goes to the Stopped State.

Dubbing:

- MIDI Start: Ends Dubbing and Starts Playing from Loop Start.
- MIDI Stop: Stops Loop Playback and Dubbing and goes to the Stopped State.

Playing:

- MIDI Start: Retrigger to start Playing from Loop Start.
- MIDI Stop: Stops Loop Playback and goes to the Stopped State.

Stopped:

- MIDI Start: Starts Loop Playback
- MIDI Stop: no action

Tempo Sync Footswitch Quantization

Tip

The H90's looper does not support MIDI Song Position Pointer (SPP) messages. Many DAWs will only send a MIDI Start command when it is played from the beginning of the transport. Certain Tempo Sync Footswitch Quantization functions will only work correctly AFTER receiving a MIDI Start command.

MIDI Clock is made up of a series 24 “ticks” per beat. Tempo Sync quantizes many of the Footswitch actions either to the next MIDI beat or the next MIDI tick. The quantization action of the Footswitches for each Looper State is as follows:

Empty:

- Record: Starts a new recording synced to the next beat ONLY if synced to an external MIDI clock source and AFTER having received a MIDI Start command. Otherwise, this begins recording on the next tick.
- Play: No action.
- Stop: No action.

Recording:

- Record: Record to Dub transition quantizes to the next beat.
- Play: Record to Play transition quantizes to the next beat.
- Stop: End recording and stop, quantized to the next beat.

Dubbing:

- Record: End Dubbing, no footswitch quantization.
- Play: End Dubbing and Start Playing from Loop Start. This action quantizes to the next tick.
- Stop: End Dubbing and Stop Playing. This action quantizes to the next beat.

Playing:

- Record: Start Dubbing, no footswitch quantization.
- Play: Start Playing from Loop Start. This action quantizes to the next tick.
- Stop: Stop Playing. This action quantizes to the next beat.

Stopped:

- Record: Starts a new recording synced to the next beat ONLY if synced to an external MIDI clock source and AFTER having received a MIDI Start command. Otherwise, this begins recording on the next tick.
- Play: Start Playing from Loop Start. This action quantizes to the next tick.
- Stop: No action.

Parameter Tempo Sync Features

The following control knobs have enhanced features for Tempo Sync allowing for perfect beat sync even when the tempo source changes.

- **Loop Play-Start Point:** When using Tempo Sync, the minimum length of audio that can be played out is 1 beat so, the Play-Start Point will display in beats allowing you start playback from 0 beats up to Loop Length minus 1 beat.

For example, if you recorded an 8 beat loop, this will range from 0 to 7 beats. Changing the Play-Start Point during Playback will apply the next time the Loop comes around and will maintain perfect beat sync with the Tempo Source.

- **Loop Play-Length:** When using Tempo Sync, the minimum length of audio that can be played out is 1 beat so, the Play-Length will display in beats allowing playback lengths of 1 beat up to the Loop Length. For example, if you recorded an 8 beat loop, the Play-Length will range from 1 to 8 beats.

Changing the Play-Length during Playback will apply the next time the Loop comes around and will maintain perfect beat sync with your Tempo Source. Of course, new Play-Lengths that don't evenly divide the total Loop Length will cause the loop to "walk" the downbeat, thus creating interesting poly-rhythms against an existing pattern.

- **Speed / Varispeed:** When using Tempo Sync, the Looper always loops about the current Play-Length number of beats in the originally recorded time base, regardless of changes to the Speed. Thus, for slower speeds the loop length will be truncated, and for faster speeds the loop will play through more than once. For example, if you record an 8 beat loop at 1x, then play out 8 beats at a Speed of 50 (.5x), the Looper will loop beats 1-4. Alternatively, if you choose to play at a speed 150 (1.5x), the loop will complete one full cycle of 8 beats, then a half cycle of 4 beats, and continue to loop this 1.5x pattern against the original time base. Please note that this Speed-based sync feature is temporarily disabled while Dubbing, allowing you to dub through an entire loop, and once you exit Dub mode moving back to Play, this sync feature will resume. This ensures that the Looper always maintains perfect timing with external audio, drum machines, etc. while providing the option to layer expressive pitched and poly-rhythmic patterns or even minutely controlled drifts that always come back on the downbeat.

Performance Parameters

- **Record:** Press the Footswitch to start recording a loop.
- **Play:** Press the Footswitch to play a loop that has been recorded. The Playmode parameter will determine how this works.
- **Stop:** Press the Footswitch to stop playback of the loop.
- **Empty:** Press the Footswitch to empty the loop.

- Undo/Redo: Press the Footswitch to undo the last overdub. Press it again to redo.
- Direction: Toggles the direction of the loop playback between forwards/backwards.
- Speed: Toggles the speed of the loop between full speed and half speed. At half speed the range of the Play Speed parameter will be limited to +/- 100.

1-Button Looper

The 1-button looper allows you to easily control the transport of the looper using a single Footswitch.

- Press once to begin recording a loop. Press again to finish recording and play the loop.
- While the loop is playing:
 - Press the Footswitch to toggle overdub on/off.
 - Press-and-hold the Footswitch to undo/redo.
- Double-press the Footswitch to stop playback of the loop.
- While the loop is stopped, press-and-hold the Footswitch to empty the loop.

Using the Looper Perform Page

When the Looper algorithm is loaded into A or B, an extra page of parameters will appear in the Perform Mode. The dedicated Looper perform page gives you access to the most important transport controls using, the H90's three on board footswitches. Unlike the other pages in Perform Mode, these footswitch cannot be assigned to other functions.

In addition to the footswitch controls, a large heads-up display provides feedback into the current state and position of the loop. The footswitch LED colors also denote the current state of the loop, for easy viewing on stage.



Fig. 3 The Looper displays A in the top right corner when loaded into Preset slot A.



Fig. 4 The Looper displays B in the top right corner when loaded into Preset slot B.

- **Record (P)**
 - Press the Footswitch to start recording a loop.
 - Once a loop is being recorded, this footswitch will transition to perform the Dub operation.
- **Play (A)**
 - Press the Footswitch to play a loop that has been recorded.
 - The Playmode parameter will determine how this works.
- **Stop (B)**
 - Press the Footswitch to stop playback of the loop.
 - While the loop is playing, press and hold the footswitch to perform the Undo/Redo operation.
 - While the loop is stopped, press and hold the footswitch to erase the loop.

Factory Presets

- 16 Beat Auto Loop
- 16 Beat Reverse Start
- 48 Beat Basic Looper
- 8 Beat Punch
- 8 Beat Punch Replace
- Basic Looper
- Dub Decay Looper
- LoFi 16 Beat
- Long Basic Looper
- Thin Loop

Modulation

Chorus

Chorus is an effect that takes a single voiced instrument and gives it the sound of many instruments playing together. This is achieved through randomly modulating several delay lines to create pitch and timing imperfections and then panning these voices in the stereo field.

- Intensity: Dry / wet mix.
- Type:
 - Liquid
 - Organic
 - Shimmer
 - Classic
- Depth: Sets the modulation sweep range from narrow to wide.
- Speed / Sensitivity: Sets the modulation sweep rate. Speed becomes Sensitivity when Shape is set to Envelope or ADSR.
- Shape: Selects the waveform, or source, of the modulation. The choices are:
 - Sine
 - Triangle
 - Peak
 - Random
 - Square
 - Ramp
 - SampHold
 - Envelope: The modulation becomes driven by the amplitude of the audio input.
 - ADSR: The modulation becomes driven by an ADSR triggered by the amplitude of the audio input.
 - Manual: When selected, the Manual Mod parameter will control the modulation.
- Feedback/Delay Offset/Filter: Controls feedback for Liquid and Shimmer. For Organic, used to scale a manual delay offset. For Classic, used to control a filter.
- Depth Mod: Controls the amount of modulation of the Depth parameter. Analogous to AM (Amplitude Modulation).
- Speed Mod: Controls the amount of modulation of the Speed parameter. Analogous to FM (Frequency Modulation).

- **Mod Rate / Mod Sens:** Sets the secondary LFO rate – determines how fast the Depth Mod and Speed Mod “wiggle” their targets. Ranges from 1/8th to 8x the Speed value. Mod Rate becomes Mod Sens when Mod Source is set to Envelope or ADSR.
- **Mod Source:** Selects the secondary LFO waveform, or source. The choices are:
 - Sine
 - Triangle
 - Peak
 - Random
 - Square
 - Ramp
 - SampHold
 - Envelope: The modulation becomes driven by the amplitude of the audio input.
 - ADSR: The modulation becomes driven by an ADSR triggered by the amplitude of the audio input.
 - Manual: When selected, the Manual Mod parameter will control the modulation.

Performance Parameters

- **Retrigger:** Retriggers the primary and secondary modulation LFOs to the beginning of their cycles. Useful for re-syncing during playback, or creative effects.
- **Speed / Brake:** The Brake engages while this switch is pressed. Short-press to toggle between Fast and Slow. Long-press to engage Brake.
- **Fast / Slow:** Press to toggle between Fast and Slow, which slows the primary and secondary LFOs by a predetermined factor. The Brake does not engage while this switch is pressed.
- **Brake (M):** Slows the LFOs at a constant rate and pauses the LFOs until the switch is released.

Factory Presets

- 70s Guitar Chorus
- Big Clone
- Chorus Bumps
- Liquid Sweetener
- PhasyChorus
- Polymodelicious
- Pulsating
- Spinning
- Warmth

Even-Vibe

A faithful emulation of the classic [Shin-ei Uni-Vibe™](#) in stereo! Imagine owning two Uni-Vibes and being able to control their LFOs for a true stereo effect, plus an envelope follower as an added bonus. A clunky foot controller is not required or included, but feel free to map your expression pedal to Speed for maximum vibes. This is not your grandad's Uni-Vibe!

- **Mix:** Controls the mix between the unprocessed input and the modulated output. Set to 50% for a Uni-Vibe in chorus mode. Set to 100% for Uni-Vibe in vibrato mode.
- **Speed:** Determines the rate of the modulation. Tempo Sync off, Hertz. On, subdivisions. Like a classic Uni-Vibe, Speed will also subtly effect the intensity of the modulation. Don't overthink it.
- **Intensity:** Adjusts the depth of the modulation.
- **Width:** Adjusts the stereo width of the output.
- **Env Speed:** Adjusts how much the envelope controls the rate of the modulation. Negative values will result in slower modulation while the envelope is open, positive values will result in faster modulation.
- **Env Inten:** Adjusts how much the envelope controls the depth of the modulation. Negative values will result in less intensity of the modulation while the envelope is open, positive values will result in more intensity.
- **Softclip:** Adjusts the amount of gentle transistor soft clipping.

Performance Parameters

- **Retrigger:** Retrigger the LFO to the beginning of the cycle. Useful for re-syncing during playback, or creative effects.

Factory Presets

- Air Bubbles
- Ebb & Flow
- Even-Vibe
- Indigo Fog
- Slowly Drifting
- Widevibe

Flanger

Flanging is similar to Phasing but more intense – deeper, more numerous frequency notches.

- Intensity: Effect level.
- Type:
 - Positive: Mixes the feed-forward and feedback signals, non-inverted.
 - Negative: Mixes the feed-forward and feedback signals, inverted.
 - Jet: Uses a special arrangement that creates a very extreme effect (like a jet taking off).
 - Thru-0: Uses two different delay line that flange against each other, so the flange offset goes through 0.
- Depth: Sets the modulation sweep range from narrow to wide.
- Speed / Sensitivity: Sets the modulation sweep rate. Speed becomes Sensitivity when Shape is set to Envelope or ADSR.
- Shape: Selects the waveform, or source, of the modulation. The choices are:
 - Sine
 - Triangle
 - Peak
 - Random
 - Square
 - Ramp
 - SampHold
 - Envelope: The modulation becomes driven by the amplitude of the audio input.
 - ADSR: The modulation becomes driven by an ADSR triggered by the amplitude of the audio input.
 - Manual: When selected, the Manual Mod parameter will control the modulation.
- Delay Offset: Set Delay offset.
- Depth Mod: Controls the amount of modulation of the Depth parameter. Analogous to AM (Amplitude Modulation).
- Speed Mod: Controls the amount of modulation of the Speed parameter. Analogous to FM (Frequency Modulation).
- Mod Rate / Mod Sens: Sets the secondary LFO rate – determines how fast the Depth Mod and Speed Mod “wiggle” their targets. Ranges from 1/8th to 8x the Speed value. Mod Rate becomes Mod Sens when Mod Source is set to Envelope or ADSR.
- Mod Source: Selects the secondary LFO waveform, or source. The choices are:
 - Sine
 - Triangle
 - Peak

- Random
- Square
- Ramp
- SampHold
- Envelope: The modulation becomes driven by the amplitude of the audio input.
- ADSR: The modulation becomes driven by an ADSR triggered by the amplitude of the audio input.
- Manual: When selected, the Manual Mod parameter will control the modulation.

Performance Parameters

- Retrigger: Retrigger the primary and secondary modulation LFOs to the beginning of their cycles. Useful for re-syncing during playback, or creative effects.
- Speed / Brake: The Brake engages while this switch is pressed. Short-press to toggle between Fast and Slow. Long-press to engage Brake.
- Fast / Slow: Press to toggle between Fast and Slow, which slows the primary and secondary LFOs by a predetermined factor. The Brake does not engage while this switch is pressed.
- Brake (M): Slows the LFOs at a constant rate and pauses the LFOs until the switch is released.

Factory Presets

- Barrel Roll
- ClassicFlangeSweep
- ClassicFlangeSweep2
- Long Flyby
- PulsarFlange
- PulsingFlange
- PulsingFlange2
- PulsingWowFlange
- Rotator Flange
- Subtle-Drastic Flange
- SubtleFlange
- SubtleFlange2
- SugarFlange

Harmadillo

Harmadillo is a flexible harmonic tremolo, offering everything from soulful lush tremolos to psychedelic mind-bending weirdness.

An ordinary tremolo automatically fades your signal up and down using a low frequency oscillator (LFO). Because your sound is faded down for part of the waveform, the overall sound seems quieter. Many tremolo pedals provide a gain or volume control to help offset this volume loss.

A harmonic tremolo takes a different approach. It splits the signal into low and high frequency bands and then applies the LFO to the low band and an inverted copy of the LFO to the high band. When the low band becomes louder, the high band becomes quieter, and vice versa. This way, the overall volume doesn't drop as much because one part of the sound spectrum is always audible. This also means that the upper harmonics receive a different tremolo than the fundamental, hence the name "harmonic tremolo".

Harmadillo features three ENV (envelope follower) controls that use your picking and playing dynamics to affect the tremolo's rate, depth, and crossover frequency. These controls can make subtle or drastic changes to your sound and add flexibility to the effect. When first getting to know Harmadillo, we recommend setting the ENV controls to 0 so that you can get a feel for the basic controls first. Once you are familiar with those, it will be easier to see how the ENV controls can be used to add expression to your playing.

- **Depth:** This is the depth of the low and high bands of the tremolo. At 0, the tremolo will have no effect on the volume of the bands. At 100, the bands will be completely faded in and out.
- **Rate:** This is the base rate of the tremolo. When Tempo Sync is ON, this becomes a multiplier on the tapped BPM value. The Env Rate control can change the apparent rate, so if the rate that you are hearing is different from the value of the Rate control, try setting the value of Env Rate to 0.
- **Shape:** The shape of the tremolo waveform. The same shape is used for both high and low bands. The shapes describe what happens to the low band, since it's usually the main part of your sound; the high band will change in the opposite direction. Options are:
 - **Sine:** A sine wave. This shape works well for producing a smooth, subtle tremolo.
 - **Fat Sine:** A "fat" sine wave that spends more time near its minimum and maximum values. This waveform sounds similar to Sine, but with slightly more throb.
 - **Phat Sine:** An even "fatter" sine wave that spends even more time at its minimum and maximum values.
 - **Triangle:** A linear up/down ramp. Like sine, this is a good shape for smooth, subtle tremolo.
 - **Ramp Dn:** A downward ramp for the low band, and an upward ramp for the high band. The low band will have a plucked attack while the high band will fade in.
 - **Ramp Up:** An upward ramp for the low band, and a downward ramp for the high band. The low band will fade in, while the high band will have a plucked attack.
 - **Pulse X:** A pulse wave with selectable duty cycle (X). The low band will stay at its maximum amplitude for X% of the cycle, then jump to its minimum amplitude, set by Depth and Env Depth. Options are 25%, 33%, 50%, 66%, and 75%. This shape can be especially interesting when paired with a delay pedal whose time is related to Harmadillo's rate.
 - **Lump:** The first half of a sine wave. The low band's waveform is rounded at the maximum and pointed at the minimum. This shape is good for making fast, vibey tremolos.

- **Rump:** The second half of a sine wave (Rump is the inverse of Lump). The low band's waveform is pointed at the maximum and rounded at the minimum. Like rump, this is a good shape for fast, vibey tremolos.
- **Slope X:** A curved ramp wave with an adjustable slope.
 - X = 0: downward curve for the low band, upwards curve for the high band
 - X = 50: symmetric curves for low and high (similar to the RUMP shape)
 - X = 100: upward curve for the low band, downwards curve for the high band
- **X-Over:** This control determines where in the frequency spectrum the low band ends and the high frequency band begins. In practice, each band rolls off around the crossover frequency, so they overlap a bit. The X-Over control allows you to adjust the amount of overlap; see below.

To mimic an ordinary tremolo, set X-Over to its maximum value of 12,000 Hz. Most of an electric guitar's sound spectrum is below 6,000 Hz. Any audio above 12,000 Hz (i.e., hardly any sound) will be heard in the high band, and everything else will be heard in the "low" band. Change X-Over gradually to morph into and out of an ordinary tremolo sound.

X-Over is especially interesting when Shape is set to an asymmetric shape such as Ramp Up. This means that for each cycle of the tremolo the portion of the signal below the X-Over value will be faded in and the portion of the signal above the X-Over value will be faded out. If you start playing a scale below the X-Over frequency and continue playing above it, the shape of the tremolo will appear to change as you cross over the X-Over frequency!

- **X-Overlap:** This control adjusts the amount of overlap between the high and low bands. Negative values will produce a cut at the crossover frequency, and positive values will produce a boost at the crossover frequency.

To explore the effect of this control set:

- X-Over to 100
- Depth to 0
- Env Depth to 0
- Drive to 0
- Env X-Over to 0

This removes the tremolo effect so you can hear the filtering. Slowly sweep the X-Over value from 100 Hz to 3,000 Hz as you play a repeated note, and listen for a boost at the crossover frequency.

Harmonic tremolo effects often have a scoop in the midrange near their crossover. You can emulate this by using negative values for X-Over. To dial in classic sounds, set Env X-Over to 0, set the X-Over frequency between 400 Hz and 900 Hz, and adjust X-Over as needed.

- Drive: This control adds warmth to the signal by mimicking the behavior of a tube amplifier's
- harmonic tremolo.
 - Env Depth: This control uses the amplitude envelope of the input to increase or decrease the tremolo's depth. Positive values increase the depth of the tremolo when you attack a note. The depth will return to the level set by the Depth control as the note decays. Additionally, louder notes will have greater depth than softer notes. Negative values reduce the tremolo when you attack a note, increasing the clarity of your attacks and making sustained notes more expressive over time. Playing louder will reduce the depth of the tremolo, and you can use large negative values to create tremolos that only appear when the input is soft.

The Env Depth control covers a large range, so we recommend starting with values closer to 0, and then adjusting the control as needed.

- Env Rate: This control uses the amplitude envelope of the input signal to affect the rate of the tremolo. With positive values, the tremolo jumps up in frequency when you attack a note and gradually returns to the original rate set by the Rate or Tap Tempo controls. The harder you play, the longer it will take to return. Negative values will temporarily reduce the rate of the tremolo when you attack a note, and the rate will return to the value set by the RATE knob or Tap Tempo as the note decays. With larger negative values and high Rate values, you can use this control to create bouncing-ball tremolo type effects. This is especially effective with the Shape control set to Pulse, Ramp Dn, Ramp Up, or Slope 0.

The Env Rate control covers a large range. At 100%, it can push the internal LFO rate up to 80 Hz, so we recommend starting with values closer to 0, and then adjusting the control as needed.

- Env X-Over: This control uses the amplitude envelope to affect the crossover frequency.

To create a swept filter effect similar to an autowah, set X-Overlap to 100, set the X-Over frequency to 200 Hz, and then increase the amount of the Env X-Over control as necessary. The frequency of the crossover filter will now track the loudness of the input signal.

You can create a single-notch phaser by turning Depth to 0, X-Overlap to -100, X-Over to 3500, and then set Env X-Over to a medium negative value, adjusting to taste. Once you have a sound you like, try slowly turning up the Depth control. Try playing long chords with these settings. In addition to the phasing effect, you will now notice that the tremolo also seems to change as a chord dies out. This is because the crossover frequency returns to the high X-Over value (3500 Hz) as the chord decays.

Try setting Shape to an asymmetric waveform (e.g., Ramp Dn) to produce waveform morphing effects as the crossover frequency changes.

- Tone: A tone control for shaping the high or low end of the output signal. Negative values roll off
- high frequencies (High Cut), and positive values roll off low frequencies (Low Cut).

Performance Parameters

- Retrigger: Retrigger the LFO to the beginning of the cycle. Useful for re-syncing during playback, or creative effects.

Factory Presets

- Basic Triangle
- Bass Comping
- Bass Pulser
- Bouncing Ball
- Delta Slide
- Double Banded
- Dreamy
- Echo Morph
- Epic Windmills
- Giant Step
- Lonely Sea
- Master Of Bands
- Mostly Harm-less
- Movin Along
- Only Tails
- Phaaaseeey
- Phriendly Vibe
- Pluck Fade
- Pseudo Ring
- Quicksand
- Rotophase
- Rotowah
- Sandblaster
- Shades
- Slowah
- Strum Pulse Decay
- Thumpluck
- Toasted Marsh-molo
- T-rem-o-ring
- Tulsa Tornado
- Tumbleweed

Instant Flanger

The Instant Flanger brings the great sound of vintage tape flanging to your pedalboard. An authentic emulation of [the original 1975 studio rackmount](#), the Instant Flanger Mk II was famously used on [David Bowie's "Ashes to Ashes"](#) and [Cyndi Lauper's "Time After Time."](#) A truly versatile tool, engineers and producers have used it for stereo sweetening, subtle modulations, double tracking, and extreme flanging effects.

- Depth: Controls the mix of wet and dry signals. At 0% the output is solely the wet signal. At 100% the output is the sum of the wet and dry signals. At -100% the output is the sum of the wet signal and the inverted dry signal.

Note

Many modulation-type effects provide mix controls. The Instant Flanger has a mix knob too, but rather than being labeled Mix, it is called Depth. Why is it called Depth, you ask? As you add more of the dry signal to the wet signal, nulls appear in the output spectrum. These nulls get deeper as the two signals approach equal amplitude. Hence you are controlling the depth of the nulls!

- **Source:** Sets the source of the modulation. This can be any combination of the following:
 - **Oscillator:** The classic LFO-controlled flanging, with a variable rate.
 - **Manual:** Controls the flanging manually.
 - **Envelope:** Lets the level of the input signal control the flanging, with adjustable threshold and release time.
- **Mode:** Adjusts the stereo width of the flanging: Shallow, Deep, and Wide.

Note

The original Instant Flanger had two unique outputs called Main and Aux. The Main output used two bucket brigade devices in series, while the Aux output only used a single Bucket Brigade. This means the delay times of the Main output are roughly double that of the Aux output. The Mode control gives you access to which of these outputs is used by the Algorithm, and it can drastically change the sound.

- In Shallow mode, all outputs will correspond to the Aux output of the hardware unit.
- In Deep mode, all outputs will correspond to the Main output of the hardware unit.
- In Wide mode, the Main output is routed to the left channel and the Aux output is routed to the right channel. Because of the different delay lengths and the fact that Main and Aux are out of phase with each other, Wide mode will sound like it is panning the signal to the left or right, depending on how the Depth knob is set.

Note that if you are using a mono output, Wide mode will be the same as Deep mode.

- Rate: Controls the rate of the LFO between 0.01 Hz and 20 Hz.
- LFO Width: Adjusts the range of the sweep of the Flanger's LFO. 100 is the widest possible sweep and equivalent to the range of the original hardware.
- Env Thresh: Controls the threshold of the envelope follower, between -60 dB and 0 dB. An input signal will cause the biggest phase shift when it reaches the threshold level.
- Env Release: Sets the release time of the envelope follower. Release times can vary from 10 milliseconds to 10 seconds.
- Feedback: Controls the feedback of the flanger output. 0% sends none of the output back to the input to the bucket brigades, and 100% sends the maximum amount of output back to the input of the bucket brigades.
- Low Cut: Applies a high-pass filter to the input signal before it is delayed. The original signal is still mixed with the output of the delays, but the flanging effect only acts on high frequencies.
- Manual: Provides manual control of the flanging. 0% corresponds to setting the bucket brigades to their longest delay times, while 100% sets them to their shortest.

Performance Parameters

- Retrigger: Retrigger the LFO to the beginning of the cycle. Useful for re-syncing during playback, or creative effects.

Factory Presets

- Bending Corn
- EXP Pedal Flange
- Elastic Dreams
- Fairy Wings
- Flange the Attack
- Flanjo
- Ginormous Bass
- Instant Flanger
- Instant Ra Man
- Mids Come Alive
- Rotary Flange
- Through the Tube
- Vintage Mod

Instant Phaser

Released in 1972, [Eventide's Instant Phaser](#) began the studio effects revolution by successfully simulating tape flanging, an effect that's been at the core of legendary albums for the last five decades. Modeled on the original hardware unit, the Instant Phaser Algorithm accomplishes the same legendary

sound with all the analog personality, smooth modulations, and inherent musicality. Its capabilities have been expanded, and now you can even take your phaser on an excursion from the 70s far into the future with the delightfully characteristic “Age” knob. Outfitted with a complete host of control options, the Instant Phaser is out of the rack and into your pedal arsenal.

- **Depth:** Controls the mix of wet and dry signals. At 0% the output is solely the phase shifted signal. At 100% the output is the addition of the phase shifted signal and the input. This will cause a gain of 6dB at certain frequencies depending on the phase shift.
- **Feedback:** Controls the feedback of the phase shift sections. 0% sends none of the output back to the input to the phase shift sections and 100% sends the maximum amount of output back to the input of the phase shift sections.
- **Mode:** Adjusts the stereo width of the phasing: Shallow, Deep, and Wide

Note

The original Instant Phaser had two unique outputs called Main and Aux. The main output had two extra stages of phase shifting compared to the aux out, which means the two outputs are 180 degrees out of phase with each other. The Mode control gives you access to which of these outputs is used by the Algorithm, and it can drastically change the sound.

- In Shallow mode, all outputs will correspond to the Aux output of the hardware unit.
- In Deep mode, all outputs will correspond to the Main output of the hardware unit.
- In Wide mode, the Main output is routed to the left channel and the Aux output is routed to the right channel.

Note that if you are using a mono output, Wide mode will be the same as Deep mode.

- **Age:** Controls the age of the electrical components that make up the Instant Phaser. 0% is a factory fresh unit from 1971, 25% is the box we modeled as it is now, 100% is a very ungracefully aged Instant Phaser.
- **Source:** Sets the source of the modulation. This can be any combination of the following:
 - **Oscillator:** The classic LFO-controlled phasing, with a variable rate.
 - **Manual:** Controls the phasing manually.

- Envelope: Lets the level of the input signal control the phasing, with adjustable threshold and release time.
- LFO Rate: Controls the rate of the LFO from 0.01Hz to 20Hz
- LFO Width: Adjusts the range of the sweep of the Phaser's LFO. 100 is the widest possible sweep and equivalent to the range of the original hardware.
- Env Thresh: Controls the threshold of the envelope follower. This is variable from -60dB to -0dB.
- Env Release: Sets the release time of the envelope follower. Release times can vary from 10 milliseconds to 10 seconds.
- Manual: Provides manual control of phasing. 0% moves the nulls in the frequency response to their highest position in frequency, 100% moves them to their lowest position in frequency.

Performance Parameters

- Retrigger: Retrigger the LFO to the beginning of the cycle. Useful for re-syncing during playback, or creative effects.

Factory Presets

- Attack the Strings
- EXP Pedal Phase
- EXPress Yourself
- Emotional Width
- Expansion Pedal
- Fine Faze
- Flutter
- Id Coming Through
- Instant Phaser
- Live Wire
- Low Mid Phase
- Pink Phase
- Slow & Low

ModFilter

ModFilter is a set of modulated filters!

- Intensity: Effect level. Controls a combination of base filter frequency and resonance.
- Type:
 - Lowpass
 - Bandpass
 - Highpass

- **Depth:** Sets the modulation sweep range from narrow to wide. Controls the frequency offset of the left and right channels to create a stereo image.
- **Speed / Sensitivity:** Sets the modulation sweep rate. Speed becomes Sensitivity when Shape is set to Envelope or ADSR.
- **Shape:** Selects the waveform, or source, of the modulation. The choices are:
 - Sine
 - Triangle
 - Peak
 - Random
 - Square
 - Ramp
 - SampHold
 - Envelope: The modulation becomes driven by the amplitude of the audio input.
 - ADSR: The modulation becomes driven by an ADSR triggered by the amplitude of the audio input.
 - Manual: When selected, the Manual Mod parameter will control the modulation.
- **Unused / Stereo Width:** In mono, this control is not used. In stereo, this control shifts the phase of the right channel's LFO creating a tremolo that will move from left to right in the stereo field. When set to Max, the right channel will be 180 degrees out of phase with the left, creating an autopanner.
- **Depth Mod:** Controls the amount of modulation of the Depth parameter. Analogous to AM (Amplitude Modulation).
- **Speed Mod:** Controls the amount of modulation of the Speed parameter. Analogous to FM (Frequency Modulation).
- **Mod Rate / Mod Sens:** Sets the secondary LFO rate – determines how fast the Depth Mod and Speed Mod “wobble” their targets. Ranges from 1/8th to 8x the Speed value. Mod Rate becomes Mod Sens when Mod Source is set to Envelope or ADSR.
- **Mod Source:** Selects the secondary LFO waveform, or source. The choices are:
 - Sine
 - Triangle
 - Peak
 - Random
 - Square
 - Ramp
 - SampHold
 - Envelope: The modulation becomes driven by the amplitude of the audio input.
 - ADSR: The modulation becomes driven by an ADSR triggered by the amplitude of the audio input.
 - Manual: When selected, the Manual Mod parameter will control the modulation.

Performance Parameters

- **Retrigger:** Retriggers the primary and secondary modulation LFOs to the beginning of their cycles. Useful for re-syncing during playback, or creative effects.
- **Speed / Brake:** The Brake engages while this switch is pressed. Short-press to toggle between Fast and Slow. Long-press to engage Brake.
- **Fast / Slow:** Press to toggle between Fast and Slow, which slows the primary and secondary LFOs by a predetermined factor. The Brake does not engage while this switch is pressed.
- **Brake (M):** Slows the LFOs at a constant rate and pauses the LFOs until the switch is released.

Factory Presets

- Bass Auto Wah
- Nervous Filter
- BubblyFilter
- TremModFilter
- HyperWah
- WateryFilter Dark
- Jupiter Reacts
- WateryFilterBright

Phaser

Phaser is an effect created by a series of all pass filters (phase shifters). When the output of the filters is mixed with the dry signal sharp notches are created in the frequency spectrum of the output; by modulating the center frequencies of the filters the notches move giving a sense of motion to the effect.

- **Intensity:** Effect level.
- **Type:**
 - **Positive:** Mixes the feed-forward and feedback signals, non-inverted.
 - **Negative:** Mixes the feed-forward and feedback signals, inverted.
 - **Feedback:** No feed-forward signal; Feedback only.
 - **Bi-phase:** Based on the topology of the [Mu-Tron Bi-Phase](#).
 - **PhaseX0:** A [phase 90](#) clone (but it also does phase 180 and some others if you check Stages).
- **Depth:** Sets the modulation sweep range from narrow to wide.
- **Speed / Sensitivity:** Sets the modulation sweep rate. Speed becomes Sensitivity when Shape is set to Envelope or ADSR.
- **Shape:** Selects the waveform, or source, of the modulation. The choices are:
 - Sine
 - Triangle
 - Peak
 - Random

- Square
- Ramp
- SampHold
- Envelope: The modulation becomes driven by the amplitude of the audio input.
- ADSR: The modulation becomes driven by an ADSR triggered by the amplitude of the audio input.
- Manual: When selected, the Manual Mod parameter will control the modulation.
- Stages/Direction: This control allows you to select the number of digital filters. For Bi-phase, selects the sweep direction.
- Depth Mod: Controls the amount of modulation of the Depth parameter. Analogous to AM (Amplitude Modulation).
- Speed Mod: Controls the amount of modulation of the Speed parameter. Analogous to FM (Frequency Modulation).
- Mod Rate / Mod Sens: Sets the secondary LFO rate – determines how fast the Depth Mod and Speed Mod “wobble” their targets. Ranges from 1/8th to 8x the Speed value. Mod Rate becomes Mod Sens when Mod Source is set to Envelope or ADSR.
- Mod Source: Selects the secondary LFO waveform, or source. The choices are:
 - Sine
 - Triangle
 - Peak
 - Random
 - Square
 - Ramp
 - SampHold
 - Envelope: The modulation becomes driven by the amplitude of the audio input.
 - ADSR: The modulation becomes driven by an ADSR triggered by the amplitude of the audio input.
 - Manual: When selected, the Manual Mod parameter will control the modulation.

Performance Parameters

- Retrigger: Retrigger the primary and secondary modulation LFOs to the beginning of their cycles. Useful for re-syncing during playback, or creative effects.
- Speed / Brake: The Brake engages while this switch is pressed. Short-press to toggle between Fast and Slow. Long-press to engage Brake.
- Fast / Slow: Press to toggle between Fast and Slow, which slows the primary and secondary LFOs by a predetermined factor. The Brake does not engage while this switch is pressed.
- Brake (M): Slows the LFOs at a constant rate and pauses the LFOs until the switch is released.

Factory Presets

- Ain't Talkin 'Bout Phase
- FunkPhase
- Lou-nivibe
- Phaser Wah
- Phat Phase
- SawModPhaser
- StoppedPhase
- VibraPhaser

Q-Wah

The Q-Wah effect can be a classic wah wah effect, an auto wah, or a combination of both. Use Depth and/or other wave shapes to create more complex wah sounds.

- Q-Intensity: Increases the resonance of the wah effect.
- Type:
 - Wah Wah
 - Vocal Wah
 - Bass Wah
 - Bass Vocal

Note

The Bass types retain the low end as the wah filter climbs to higher frequencies.

- Depth / Vowel / End Vowel:
 - When Effect Type is Wah Wah or Bass Wah, Depth sets the modulation sweep range from narrow to wide.
 - When Effect Type is Vocal Wah or Bass Vocal, and “Bottom / Start Vowel” is set to Bottom, Vowel will determine the vowel sound of the vocal wah.
 - When Effect Type is Vocal Wah or Bass Vocal, and “Bottom / Start Vowel” is set to Start Vowel, End Vowel sets the ending vowel for a talk-box style effect.

List of available vowels:

- B..EA..T
 - M..I..X
 - S..E..T
 - S..A..X
 - H..O..T
 - R..A..W
 - W..OO..D
 - T..U..NE
 - F..U..N
 - B..IR..D
-
- **Speed / Sensitivity:** Sets the modulation sweep rate. Speed becomes Sensitivity when Shape is set to Envelope or ADSR.
 - **Shape:** Selects the waveform, or source, of the modulation. The choices are:
 - Sine
 - Triangle
 - Peak
 - Random
 - Square
 - Ramp
 - SampHold
 - **Envelope:** The modulation becomes driven by the amplitude of the audio input. Use this to emulate an autowah.
 - **ADSR:** The modulation becomes driven by an ADSR triggered by the amplitude of the audio input.
 - **Manual:** When selected, the Manual Mod parameter will control the modulation. Use this to emulate a classic wah.
 - **Bottom / Start Vowel:**

When Effect Type is Wah Wah or Bass Wah, Bottom sets the base frequency.

When Effect Type is Vocal Wah or Bass Vocal, the first half of this parameter sets Bottom and the second half sets Start Vowel for a talk-box style effect.
 - **Depth Mod:** Controls the amount of modulation of the Depth parameter. Analogous to AM (Amplitude Modulation).

- Speed Mod: Controls the amount of modulation of the Speed parameter. Analogous to FM
- (Frequency Modulation).
- Mod Rate / Mod Sens: Sets the secondary LFO rate – determines how fast the Depth Mod and Speed Mod “wiggle” their targets. Ranges from 1/8th to 8x the Speed value. Mod Rate becomes Mod Sens when Mod Source is set to Envelope or ADSR.
- Mod Source: Selects the secondary LFO waveform, or source. The choices are:
 - Sine
 - Triangle
 - Peak
 - Random
 - Square
 - Ramp
 - SampHold
 - Envelope: The modulation becomes driven by the amplitude of the audio input.
 - ADSR: The modulation becomes driven by an ADSR triggered by the amplitude of the audio input.
 - Manual: When selected, the Manual Mod parameter will control the modulation.

Performance Parameters

- Retrigger: Retriggers the primary and secondary modulation LFOs to the beginning of their cycles. Useful for re-syncing during playback, or creative effects.
- Speed / Brake: The Brake engages while this switch is pressed. Short-press to toggle between Fast and Slow. Long-press to engage Brake.
- Fast / Slow: Press to toggle between Fast and Slow, which slows the primary and secondary LFOs by a predetermined factor. The Brake does not engage while this switch is pressed.
- Brake (M): Slows the LFOs at a constant rate and pauses the LFOs until the switch is released.

Factory Presets

- Auto Wah
- BigModdedPlanetSweep
- High Quack
- LazyPhasyWah
- LessEvenAutoWah
- Low Quack
- Mumbler
- Nervous Wah
- OttaWah
- PhasyWah
- SlowSweepWithTreats
- SoftChopper
- SquareModWah
- Talking Back
- Talking Bass
- VibraPhasyWah
- Vintage Wah
- Wah-Bravibe

RingMod

Ring Modulator is an effect created by multiplying an input signal by an audio frequency waveform; the result is a waveform containing the sums and differences of those frequencies and their partials. This creates a waveform with complex (and usually nonharmonic) bell-like overtones. By using the Speed Mod control to modulate this carrier frequency you can create useful and interesting sounds.

- Intensity: Effect level.
- Type:
 - Ring
 - String
 - Pitch
- Pitch: If Type is set to Pitch, RingMod will pitch track the incoming audio and modulate it by a waveform that is shifted up to +/- 1200 c from your input, giving you a consistent synth-like tone across all notes. This parameter is unused when Type is set to Ring or String.
- Speed / Sensitivity: Sets the modulation sweep rate. Speed becomes Sensitivity when Shape is set to Envelope or ADSR.
- Shape: Selects the waveform, or source, of the modulation. The choices are:
 - Sine
 - Triangle
 - Peak
 - Random
 - Square
 - Ramp
 - SampHold
 - Envelope: The modulation becomes driven by the amplitude of the audio input.
 - ADSR: The modulation becomes driven by an ADSR triggered by the amplitude of the audio input.
 - Manual: When selected, the Manual Mod parameter will control the modulation.
- Tone: Rolls off the high frequencies as it is turned clockwise.
- Depth Mod: Slightly detunes the right and left voices, which creates a stereo field.
- Speed Mod: Controls the amount of modulation of the Speed parameter. Analogous to FM (Frequency Modulation).
- Mod Rate / Mod Sens: Sets the secondary LFO rate – determines how fast the Depth Mod and Speed Mod “wiggle” their targets. Ranges from 1/8th to 8x the Speed value. Mod Rate becomes Mod Sens when Mod Source is set to Envelope or ADSR.
- Mod Source: Selects the secondary LFO waveform, or source. The choices are:
 - Sine

- Triangle
- Peak
- Random
- Square
- Ramp
- SampHold
- Envelope: The modulation becomes driven by the amplitude of the audio input.
- ADSR: The modulation becomes driven by an ADSR triggered by the amplitude of the audio input.
- Manual: When selected, the Manual Mod parameter will control the modulation.

Performance Parameters

- Retrigger: Retriggers the primary and secondary modulation LFOs to the beginning of their cycles. Useful for re-syncing during playback, or creative effects.
- Speed / Brake: The Brake engages while this switch is pressed. Short-press to toggle between Fast and Slow. Long-press to engage Brake.
- Fast / Slow: Press to toggle between Fast and Slow, which slows the primary and secondary LFOs by a predetermined factor. The Brake does not engage while this switch is pressed.
- Brake (M): Slows the LFOs at a constant rate and pauses the LFOs until the switch is released.

Factory Presets

- BuzzBells
- Ring Whammy
- Ring's Trem 2 Faster
- ElectricityRing
- Ring's Chorus
- Ring's Trem2
- Guitar Drums
- Ring's Leslie Fast
- Static
- HellsBells
- Ring's Leslie Slow
- Trem Turns Ugly
- Interference
- Ring's Trem
- What's That Smell

Rotary

A rotating speaker ([Leslie](#)) simulation, with Standard or Giant flavors. A Leslie is built using a rotating speaker for low and mid-range frequencies and a rotating treble horn for highs. With Rotary Mod you can

control the speed of the rotor and horn independently, adjust the mix of the two, and modulate the speeds themselves, for interesting and dynamic effects.

- **Mix:** Wet/Dry mix, where 100 is an all wet signal. It has a special nonlinear taper which puts most of the knob travel in the most usable range.
- **Type:** Select the size of the cabinets.
 - Standard
 - Giant
- **Rotor Spd:** Sets the rotation speed of the Rotor (low frequency) speaker, from 0.10 Hz to 20 Hz.
- **Horn Spd:** Sets the rotation speed of the Horn (high frequency) speaker, from 0.10 Hz to 20 Hz.
- **Rtr/Hrn Mix:** Sets the balance between the Rotor level and Horn level.
- **Tone:** Rolls off the high frequencies as it is turned clockwise.
- **Depth Mod:** Controls the amount of modulation of the Depth parameter. Analogous to AM (Amplitude Modulation).
- **Speed Mod:** Controls the amount of modulation from the secondary LFO that is applied to the Rotor Spd and Horn Spd parameters. Analogous to FM (Frequency Modulation).
- **Mod Rate / Mod Sens:** Sets the secondary LFO rate – determines how fast the Depth Mod and Speed Mod “wobble” their targets. Ranges from 1/8th to 8x the Rotor Spd value. Mod Rate becomes Mod Sens when Mod Source is set to Envelope or ADSR.
- **Speed:** Sets the modulation sweep rate.
- **Mod Source:** Selects the secondary LFO waveform, or source. The choices are:
 - Sine
 - Triangle
 - Peak
 - Random
 - Square
 - Ramp
 - SampHold
 - Envelope: The modulation becomes driven by the amplitude of the audio input.
 - ADSR: The modulation becomes driven by an ADSR triggered by the amplitude of the audio input.
 - Manual: When selected, the Manual Mod parameter will control the modulation.

Performance Parameters

- **Retrigger:** Retrigger the primary and secondary modulation LFOs to the beginning of their cycles. Useful for re-syncing during playback, or creative effects.

- Speed / Brake: The Brake engages while this switch is pressed. Short-press to toggle between Fast and Slow. Long-press to engage Brake.
- Fast / Slow: Press to toggle between Fast and Slow, which slows the primary and secondary LFOs by a predetermined factor. The Brake does not engage while this switch is pressed.
- Brake (M): Slows the LFOs at a constant rate and pauses the LFOs until the switch is released.

Factory Presets

- AutoFastSlowRotary
- AutoFastSlowRotary2
- BassStillRotary
- Big Fat Cabinet
- Black Sun
- Hyper Rotor
- JazzyRotary
- Leslie
- OldTyme Radio
- Slowly Rotate
- Spaceship Rotary
- Treble Spin
- Whirling Dervish

Sticky Tape

Classic Tape echo effects are loved for the character, grit, and modulation that they impart. Sticky Tape opens up a world of tape tone possibilities, without the complexity. Dial in a bit of drive and compression to sweeten up your clean tone, or turn up the Wow & Flutter and embrace the lo-fi. Dual tape machines with offset and width controls offer a wide range of doubling or slapback echo effects, with bonus Flange performance parameters to get that classic, dramatic, studio style tape flange. Just like a reel tape machine (pun intended), Sticky Tape will chew up anything you can throw at it and spit it out sounding warmer, fatter, and full of tapified goodness.

- Mix: Controls the amount of dry and tapified signal.
- Compression: How much compression is applied. This is based off of the compression section of the DBX compander found in many professional tape machines.

NOTE: Gain is automatically applied after the compression to try and maintain constant signal level. The Compression knob has been tuned for both Guitar and Bass. It is especially important to have the Instrument Type set correctly for Bass input and high Compression amounts.

- Rec Drive: How much gain is applied before going in to the tape emulation.
- Tape Speed: Controls the nominal speed at which the two tape machines are running. This affects the tone of the signal.
- W&F Amount: Adjusts the amount of wow and flutter applied.

NOTE: With no offset, or no flanging engaged this will sound like detuning. With offset, or a flange engaged this sounds like modulation.

- **W&F Rate:** Controls the speed of the wow and flutter. 10 is a faster, more fluttery sound and 0 is more wowy.
- **Filter:** A simple tone control applied after the tape processing.
- **Width:** When stereo outputs are connected this pans the two tape machines to opposite sides.

Note: When Offset is 0.0, or only a single output is connected, this control will do nothing.

- **Machine 2 Offset:** Controls how delayed Machine 2 is from Machine 1 by adjusting its speed. At 0, the machines are running perfectly in sync. 10 adds enough delay to get into slapback territory.

NOTE: When no offset is applied, a default range is used when using the Flange performance switches. If an offset is applied, then the offset is treated as the range.

- **Flange Length:** Controls the rate of the flange performance parameters. This represents the time it takes for the flange to travel 1/2 of its period.

Performance Parameters

- **Flange (M):** A momentary performance switch to engage the flange. This changes Machine 2's speed by an amount determined by either the offset, or a default setting, and a rate determined by the flange length knob. Hold it down and it's like your thumb is on the reel, lift up and the speed of Machine 2 will return to its original setting.
- **Flange:** A latching performance switch which simply turns on or off an automatic flange.

TremoloPan

Tremolo is an effect that is created by modulating the level of the incoming audio with a LFO. With this effect, as you turn the Width knob, it will shift the phase of the right channel's LFO creating a tremolo that will move from left to right in the stereo field. When the Width is full clockwise, the right channel will be 180 degrees out of phase with the left, creating an autopanner.

- **Drive / Edge:**
 - When Effect Type is set to Bias, this controls the amount of Drive. For high input levels, setting this to high levels can cause overload distortion.

- When Effect Type is set to Opto, this controls the input's [slew rate](#) (Edge) and, depending on the input signal, may only have a subtle effect.
- Type
 - Bias: Tube-inspired.
 - Opto: [Opto-coupled](#).
- Depth: Sets the modulation sweep range from narrow to wide.
- Speed / Sensitivity: Sets the modulation sweep rate. Speed becomes Sensitivity when Shape is set to Envelope or ADSR.
- Shape: Selects the waveform, or source, of the modulation. The choices are:
 - Sine
 - Triangle
 - Peak
 - Random
 - Square
 - Ramp
 - SampHold
 - Envelope: The modulation becomes driven by the amplitude of the audio input.
 - ADSR: The modulation becomes driven by an ADSR triggered by the amplitude of the audio input.
 - Manual: When selected, the Manual Mod parameter will control the modulation.
- Spread / Width:
 - Mono Out: In mono, this control spreads the tremolo and make the sound more smooth.
 - Stereo Out: In stereo, this control shifts the phase of the right channel's LFO creating a tremolo that will move from left to right in the stereo field. When set to Max, the right channel will be 180 degrees out of phase with the left creating an autopanner.
- Depth Mod: Controls the amount of modulation of the Depth parameter. Analogous to AM (Amplitude Modulation).
- Speed Mod: Controls the amount of modulation of the Speed parameter. Analogous to FM (Frequency Modulation).
- Mod Rate / Mod Sens: Sets the secondary LFO rate – determines how fast the Depth Mod and Speed Mod “wiggle” their targets. Ranges from 1/8th to 8x the Speed value. Mod Rate becomes Mod Sens when Mod Source is set to Envelope or ADSR.
- Mod Source: Selects the secondary LFO modulation source. The choices are:
 - Sine
 - Triangle
 - Peak
 - Random
 - Square

- Ramp
- SampHold
- Envelope: Mod Rate becomes Mod Sens and is driven by the amplitude of the audio input.
- ADSR: Mod Rate becomes Mod Sens driven by an ADSR triggered by the amplitude of the audio input.
- Manual: When selected, the Manual Mod parameter will control the modulation.

Performance Parameters

- Retrigger: Retrigger the primary and secondary modulation LFOs to the beginning of their cycles. Useful for re-syncing during playback, or creative effects.
- Speed / Brake: The Brake engages while this switch is pressed. Short-press to toggle between Fast and Slow. Long-press to engage Brake.
- Fast / Slow: Press to toggle between Fast and Slow, which slows the primary and secondary LFOs by a predetermined factor. The Brake does not engage while this switch is pressed.
- Brake (M): Slows the LFOs at a constant rate and pauses the LFOs until the switch is released.

Factory Presets

- Chopper Trem
- Flutter Trem
- HyperChopTrem
- I Walk Alone
- Modacity
- Panning Tremo
- Pulsing Trem
- RampChopper
- Special Agent Factor
- Square Chopper
- Tumbleweed Trem

Tricerachorus

TriceraChorus is inspired by the classic tri-choruses and stompbox choruses of the 1970s and early 1980s. These units used bucket brigade delay (BBD) chips to create chorusing. TriceraChorus pairs rich BBD-style trichorusing with another classic effect of the 1980s: Eventide MicroPitch detuning. This effect can be used to thicken the sound, to add static chorusing, and to spread the stereo field by detuning the left and right signals in opposite directions.

TriceraChorus has three chorus voices: Left (L), Center (C), and Right (R). Each voice uses a dedicated LFO to modulate a delay at the frequency set by the Rate knob. The modulated signals for the Left and Right voices are -120 and 120 degrees out of phase relative to the Center modulation signal. The combination of the three modulated delays creates lush chorus sounds.

The Depth L / Depth C / Depth R knobs control the depth of the respective voices. Larger depth values increase the amount of delay modulation, creating greater changes in pitch. When a depth control is set to Off, that voice is removed from the output, and the volume levels of the other voices will be automatically adjusted to maintain a constant level.

- Chorus Mix / Vibrato / Chorale Mix: Global mix control for chorusing and has two modes, Chorus and Chorale. Chorus and Chorale Mix levels are independent of Detune Mix (see below).
 - Chorus Mode (0 - 99 range on left half of the knob), all three chorus channel mixes, Left, Center, and Right are affected together. At 100 (Vibrato), no dry signal is present. In Chorus mode, LFO shapes are triangular from a range of 0 to 75. After 75, the LFO morphs from triangular to sinusoidal at 100.
 - Chorale Mode (99 - 0 range on right half of the knob) adds two fixed rate LFOs, one slow and one fast, to the primary LFOs creating an effect similar to combining the Preset and Manual modes on the [DYTRONICS TriChorus](#). This increases the complexity of the modulation, producing a richer sound. In Chorale mode, all LFO shapes are sinusoidal throughout the range of the control.
- Rate: This is the base rate of the chorus modulation, from 0.1 Hz to 20 Hz. When Tempo Sync is On, this becomes a multiplier on the tapped BPM value. The Env Rate control can change the apparent rate, so if the rate that you are hearing is different from the value of the Rate control, try setting the value of Env Rate to 0.
- Depth L: Chorus modulation depth of the Left voice. From Off, to 100. When Off, the voice is removed from the mix, and the levels of the other voices are automatically adjusted to preserve the wet-dry blend.

In mono to stereo routing, if Depth R is Off but Depth L is active, the chorused signal will be routed to the left and the dry signal will be routed to the right. This is a classic technique for producing a wider stereo image.

- Depth C: Chorus modulation depth of the Center voice. From Off, to 100. When Off, the voice is removed from the mix, and the levels of the other voices are automatically adjusted to preserve the wet-dry blend.
- Depth R: Chorus modulation depth of the Right voice. From Off, to 100. When Off, the voice is removed from the mix, and the levels of the other voices are automatically adjusted to preserve the wet-dry blend.

In mono to stereo routing, if Depth L is OFF but Depth R is active, the chorused signal will be routed to the right and the dry signal will be routed to the left. This is a classic technique for producing a wider stereo image.

- **Delay:** When Chorus Mix is in Chorus Mode, DELAY sets the minimum delay time for all voices, ranging from 0.39 mS to 200 mS. Short delays can be used to create light flanging. Typical chorus delays range from 1.5-10 mS. You can create a chorused slapback sound by using values between 50 and 100 mS.

When “Chorus Mix / Vibrato / Chorale Mix” is in Chorale Mode, the delay amount for each voice becomes a function of the Delay setting and the Depth level of each voice. In this case, the Delay becomes a range of possible delay amount for each voice. As you increase the Depth of a voice, its delay amount decreases.

- **Detune Mix:** Mix control for the Detune section of the Algorithm. The Detuners are fed from the stereo output of the Chorus voices. Detune Mix controls the stereo left and right channels at the same time and is independent of “Chorus Mix / Vibrato / Chorale Mix”.
- **Detune:** Controls both detune amounts for the left and right channels. Range is +/- 40 cents. Left and right channels get opposing amounts of detune (for example -30L/+30R). For enhanced versatility, the channels can be set with different opposing amounts. Left channel is the base detune amount and right channel can be adjusted around an 8 cent opposing window (for example -16L/+12R to -16L/+19R).
- **Env Mix / Env Rate:** Controls Amplitude Envelope assignment as well as Envelope Depth. There are two assignable Envelope modulation destinations:
 1. **Env Mix: Envelope to Mix.** Playing dynamics modulate the global “Chorus Mix / Vibrato / Chorale Mix” and Detune Mix amounts. Range is -100 to 100. Negative values decrease the mix levels when you attack a note, and can be used to increase the clarity of your attacks or make sustained notes more expressive over time. Playing louder will reduce the chorusing effect, and you can use large negative values to only allow chorusing when the input is soft. At zero, the envelope will not affect the chorus or detune mixes. Positive values increase the internal mix levels for chorus and detune from 0 up to the levels set by the mix knobs when you attack a note. For example, with Detune Mix set to 50, Chorus Mix set to 0, and Env Mix set to 50, when a note is attacked, the internal detune level will increase to 50, then decay towards 0 with the note. The chorus level, however, will not increase because it is at 0.
 2. **Env Rate: Envelope to Rate.** Playing dynamics modulate the speed of the LFO. Range is -100 to 100. With negative values, the rate of the primary LFOs will be slowed down when you attack a note, gradually returning to the value set by the Rate knob. Larger negative values can be used

with faster RATE settings to create a fade-in vibrato effect. At zero, the envelope will not affect the rate of the LFOs. With positive values, the LFOs increase from the minimum rate towards the value set by the RATE knob when you attack a note.

- **Tone:** Shapes the high or low end of the output signal. Positive values roll off high frequencies Hi Cut, 0 is flat, and negative values roll off low frequencies Lo Cut. Use the Lo Cut range to reduce muddiness. Use the Hi Cut range to roll off high frequencies for a softer sound. The tone control only affects the wet signal path. Changes to the Chorus Mix knob (or usage of Env Mix) may change the apparent effect of the Tone control. For example, a setting of Hi Cut 50 will sound brighter when the Chorus Mix knob is set at 50 versus when Chorus Mix is at 100 (Vibrato).

Performance Parameters

- **Swirl:** Adds another dimension to TriceraChorus' sound via stereo phase shifters after the Detune section to create throbbing and swooshing effects. The amount of Swirl depends on the greater level of either Chorus Mix or Detune Mix and follows the Env Mix control. Swirl speed is adjusted by Rate and follows the ENV Rate control. Use faster rates to achieve deeper Swirl effects.
- **Retrigger:** Retriggeres the LFOs to the beginning of their cycles. Useful for re-syncing during playback, or creative effects.

Factory Presets

- | | | | |
|------------------|----------------|-----------------|-----------------|
| • TriceraChorus: | • GH0\$TZ | • Schmozone | • Tribrato |
| • 2+3=5 | • Leslie Falsa | • Slow Flange | • TriceraChorus |
| • CEO | • Lush Life | • Slow Swirl | • Very Stern |
| • CFO | • Old Times | • Summer | • Vibecore |
| • Chorus Lap | • Paschorius | • Swirl Slap | • Vibrato |
| • DCUK | • Raven Chorus | • Syrupy Leslie | • Yello Fin |
| • FauxVerb | • Rum Punch | • Tail Decay | • Zwarbl |

Undulator

Undulator is Eventide's classic modulated tremolo effect from the iconic H3000 effects processor. This unique, rhythmic effect combines input swell, chained detuned delays, and ethereal feedback run through an AM/FM modulated tremolo. Additional secondary modulation allows for greater creativity

and control. Whether used for manipulating samples or adding movement to strings, pads, guitars, and keys, Undulator is a muse for creative musicians.

- Intensity: Increase the dry/effect ratio.
- Feedback: Controls the amount of feedback in the delay structure.
- Depth: Sets the tremolo sweep range, which increases in depth and intensity as the knob is turned clockwise.
- Speed / Sensitivity: Sets the rate of the tremolo. Speed becomes Sensitivity when Shape is set to Envelope or ADSR.
- Shape: Selects the waveform, or source, of the modulation. The choices are:
 - Sine
 - Triangle
 - Peak
 - Random
 - Square
 - Ramp
 - SampHold
 - Envelope: The modulation becomes driven by the amplitude of the audio input.
 - ADSR: The modulation becomes driven by an ADSR triggered by the amplitude of the audio input.
 - Manual: When selected, the Manual Mod parameter will control the modulation.
- Spread: Controls the amount of detuning in the delay structure.
- Depth Mod: Controls the amount of modulation of the Depth parameter. Analogous to AM (Amplitude Modulation).
- Speed Mod: Controls the amount of modulation of the Speed parameter. Analogous to FM (Frequency Modulation).
- Mod Rate / Mod Sens: Sets the secondary LFO rate – determines how fast the Depth Mod and Speed Mod “wiggle” their targets. Ranges from 1/8th to 8x the Speed value. Mod Rate becomes Mod Sens when Mod Source is set to Envelope or ADSR.
- Mod Source: Selects the secondary LFO waveform, or source. The choices are:
 - Sine
 - Triangle
 - Peak
 - Random
 - Square
 - Ramp
 - SampHold
 - Envelope: The modulation becomes driven by the amplitude of the audio input.

- **ADSR:** The modulation becomes driven by an ADSR triggered by the amplitude of the audio input.
- **Manual:** When selected, the Manual Mod parameter will control the modulation.

Performance Parameters

- **Retrigger:** Retriggers the primary and secondary modulation LFOs to the beginning of their cycles. Useful for re-syncing during playback, or creative effects.
- **Speed / Brake:** The Brake engages while this switch is pressed. Short-press to toggle between Fast and Slow. Long-press to engage Brake.
- **Fast / Slow:** Press to toggle between Fast and Slow, which slows the primary and secondary LFOs by a predetermined factor. The Brake does not engage while this switch is pressed.
- **Brake (M):** Slows the LFOs at a constant rate and pauses the LFOs until the switch is released.

Factory Presets

- Chopdulator
- Cloud Pulse
- Dreamdulator
- DreamyDreamulator
- DreamyDreamulator2
- Haze Cutter
- Lonesome Trail
- Never There
- Quadruple Peaks
- Time Lapse
- Tremdulator

Vibrato

Vibrato is an effect that simulates the pitch change you get by modulating a guitar string or using a whammy bar. Modulating the rate with an Expression Pedal or envelope will create some incredible vibratos. Three types of vibrato are offered – Modern, Vintage, and Retro.

- **Intensity:** Effect level.
- **Type**
 - Modern
 - Vintage
 - Retro
- **Modulation Depth:** Sets the modulation sweep range from narrow to wide.
- **Speed / Sensitivity:** Sets the modulation sweep rate. Speed becomes Sensitivity when Shape is set to Envelope or ADSR.
- **Modulation Waveform Shape:** Selects the waveform, or source, of the modulation. The choices are:
 - Sine

- Triangle
- Peak
- Random
- Square
- Ramp
- SampHold
- Envelope: The modulation becomes driven by the amplitude of the audio input.
- ADSR: The modulation becomes driven by an ADSR triggered by the amplitude of the audio input.
- Manual: When selected, the Manual Mod parameter will control the modulation.
- Unused/Stereo Width/Filter Stages: For Modern and Vintage controls the width of stereo panning (stereo mode only). For Retro selects the number of filter stages.
- Depth Mod: Controls the amount of modulation of the Depth parameter. Analogous to AM (Amplitude Modulation).
- Speed Mod: Controls the amount of modulation of the Speed parameter. Analogous to FM (Frequency Modulation).
- Mod Rate / Mod Sens: Sets the secondary LFO rate – determines how fast the Depth Mod and Speed Mod “wobble” their targets. Ranges from 1/8th to 8x the Speed value. Mod Rate becomes Mod Sens when Mod Source is set to Envelope or ADSR.
- Mod Source: Selects the secondary LFO waveform, or source. The choices are:
 - Sine
 - Triangle
 - Peak
 - Random
 - Square
 - Ramp
 - SampHold
 - Envelope: The modulation becomes driven by the amplitude of the audio input.
 - ADSR: The modulation becomes driven by an ADSR triggered by the amplitude of the audio input.
 - Manual: When selected, the Manual Mod parameter will control the modulation.

Performance Parameters

- Retrigger: Retrigger the primary and secondary modulation LFOs to the beginning of their cycles. Useful for re-syncing during playback, or creative effects.
- Speed / Brake: The Brake engages while this switch is pressed. Short-press to toggle between Fast and Slow. Long-press to engage Brake.

- Fast / Slow: Press to toggle between Fast and Slow, which slows the primary and secondary LFOs by a predetermined factor. The Brake does not engage while this switch is pressed.
- Brake (M): Slows the LFOs at a constant rate and pauses the LFOs until the switch is released.

Factory Presets

- DynaVibrato
- Quiverer
- Swamp Moon
- VibraPhaser2
- VibraVibe
- VibraVibe2
- VibraViby
- Warped Vinyl

Multi

SpaceTime

SpaceTime is a multi-effects Algorithm combining Modulation, two Delays, and Reverb into one, easy to use effect. Modulation is most similar to a chorus and is the first effect in the signal path. The Delays are based on Eventide's Vintage Delay Algorithm from the TimeFactor pedal and the Reverb section draws from both the Plate Algorithm in Eventide's SPACE pedal, as well as Eventide's ULTRA REVERB Native Plug-in. Unique to SpaceTime is the ability to route the Delays and Reverb in series or parallel after Modulation, further adding to its versatility and creative applications.

- **Mix:** Controls overall Algorithm wet/dry balance. 100% is all wet signal.
- **Mod Amt:** Adds Modulation to entire signal path. Modulation depth also increases as you go from 0 to 100.
- **Mod Rate:** Adjusts the speed of the LFO controlling the Modulation section of SpaceTime. Continuously adjustable from 0.05Hz to 12.50Hz.
- **Verb Lvl:** Adjust the output level of the Reverb and routes the Reverb in Series after the Delays or Parallel with the Delays. The first half of the knob adjusts Series Reverb level from 0 to 100 while the second half of the knob switches to Parallel routing and adjusts Reverb level from 0 to 100. Percussive playing coupled with long Delay times and short Reverb Decay times will showcase parallel routing.
- **Decay:** Sets the decay length of the Reverb in seconds or Note Divisions when with Tempo Sync ON.
- **Color:** Changes the Reverb character from small and dense (set to 0) to large and spacious (set to 100).
- **Delay Lvl:** Controls the amount of both Delays in the signal path. Can also be used to set the dry to wet blend of delayed signal sent to the Reverb in the series path. With DLY LVL set less than 50, dry signal and Delayed signal are both sent to the Reverb section. After 50, DLY LVL reduces the dry signal sent to the Reverb allowing only the delay repeats to have Reverb when the control reaches 100.
- **Delay A:** Sets the Delay time for Delay A from 0 to 2500 ms when TEMPO Sync is OFF. With TEMPO Sync ON, Delay is sync'ed to the Tempo BPM and is adjusted in note division increments from No Delay to a Whole Note in the most common note divisions.
- **Delay B:** See description for Delay A
- **Feedback:** Adjusts the amount of feedback for both delays and contains two feedback types (F1 and F2). F1 links both delay times to create a rhythmic, repeating pattern where the longer delay sets

the pattern length. The shorter delay will not repeat again until the longer delay has passed. F2 is a traditional feedback control, where delay times are independent.

Factory Presets

- Aphelion
- EventHorizon
- ExtraTerrestrial
- Faux Leslie
- Gravitation
- Hubble
- IntaStella
- Nice Chorus
- Off the Ground
- On the Verge
- Outer Limits
- Parallel Delays
- Quarter Delay
- Shadows
- Slap in Space
- Small Tight Room
- Space Cathedral
- SpaceTime
- Star Sailor
- Sunlight
- TwilightZoned
- Verb Repeats Only
- Voyage

Pitch

Multi-Voice Intelligent Pitch Shifting from the company that invented it! All the way from the original H910, to the Quadravox 4-voice harmonizer, Octaver, and PitchFlex effects. Also included is Harpegiator which creates arpeggios with selectable rhythm patterns and fuzz effects. And, of course, MicroPitch and Crystals – go-to sounds for inspiration.

Crystals

Crystals is a classic Eventide effect combining twin reverse pitch shifters, delays, feedback, and reverb. It can create out-of-this-world climbing and cascading pitched delays, unique sounding reverbs, and granular effects for helping instruments stand out in a mix.

- Mix: Wet/dry mixer, 100% is all wet signal.
- Pitch A/Pitch B Mix: Controls the ratio of the level of Pitch A to Pitch B.
- Pitch Shift A: Controls the amount of pitch shift for A in cents (1 cent = 1/100th of a semitone).
- Pitch Shift B: Controls the amount of pitch shift for B in cents (1 cent = 1/100th of a semitone).
- Reverse Delay Buffer A: Controls the length of the reverse time buffer for A. With Tempo Sync OFF, delay is displayed in ms. With Tempo Sync ON, delay can be sync'd to the tempo and is displayed as a rhythmic sub-division of the tempo beat value.
- Reverse Delay Buffer B: Controls the length of the reverse time buffer for B. With Tempo OFF, delay is displayed in ms. With Tempo ON, delay can be sync'd to the tempo and is displayed as a rhythmic sub-division of the tempo beat value.
- Reverb Mix Level: Sets the Wet/dry mix of the reverb level, where 100 is an all wet signal. Note that this mix level is part of the wet signal path, so the global Mix control will still affect the amount of wet signal being heard overall.
- Reverb Decay Rate: Selects the Reverb Decay rate.
- Feedback A: Controls level of Feedback A.
- Feedback B: Controls level of Feedback B.

Performance Parameters

- FLEX: Shifts both voices up one octave.

Factory Presets

- AreYouThere
- Classic Crystals
- Crystal Dance
- Eerie Cavern
- From A Bad Dream
- NS Reverb
- Pitch A La V
- Reverse Detune
- ReverseLows
- Seagulls
- Steampunk
- Voice On Ice
- WeirdBass

Diatonic

Diatonic pitch shifters track the notes that you're playing and shift the pitch by the selected harmonic interval based on the Key and Scale that you've selected.

Diatonic Shifter features twin independently-controlled pitch changers (A and B) with independent delays and feedback. Diatonic tracks the notes that you're playing and automatically adjusts the amount of pitch shift so that the resultant note is in key. Use the Pitch A/B control knobs to set each pitch interval. Use the Control Knobs to select the key, scale and interval.

Note

Due to the limitations of Diatonic Pitch Shifting, the pitch tracking Algorithm is monophonic and works best on single, isolated notes, and octaves.

- Mix: Wet/dry mixer, 100% is all wet signal.
- Pitch A/Pitch B Mix: Controls the ratio of the level of Pitch A to Pitch B. Note: The A/B mix is set before the feedback delays so that feedback can continue on A or B and not be affected by new audio when the Pitch Mix control is turned completely to the opposite channel. This allows you to create a mini 'looper' effect.
- Pitch Shift A: Selects the harmonic interval (pitch shift) for Pitch A.
- Pitch Shift B: Selects the harmonic interval (pitch shift) for Pitch B.
- Delay A: Controls the amount of time delay of the A pitch shifted output. With Tempo Sync OFF, delay is displayed in ms. With Tempo Sync ON, delay can be sync'd to the tempo and is displayed as a rhythmic sub-division of the tempo beat value.

- Delay B: Controls the amount of time delay of the B pitch shifted output. With Tempo OFF, delay is displayed in ms. With Tempo ON, delay can be sync'd to the tempo and is displayed as a rhythmic sub-division of the tempo beat value.
- Key: Selects the key.
 - Scale: Selects the scale. The supported scales are:
 - Major • Lydian • Harmonic Minor • Enigmatic
 - Minor • Mixolydian • Melodic Minor • Neapolitan
 - Dorian • Locrian • Whole Tone • Hungarian
 - Phrygian
 - Feedback A: Controls level of voice A Feedback. The feedback delay length is the length of either Delay A or Delay B, whichever is longer, to make sure both voices fade out simultaneously.
 - Feedback B: Controls level of voice B Feedback. The feedback delay length is the length of either Delay A or Delay B, whichever is longer, to make sure both voices fade out simultaneously.
 - Quantization - Quantizes the notes that are not in the selected key scale to fit within the selected key and scale.

Performance Parameters

- LEARN: Press-and-hold the Learn switch while playing a note and the H90 will set the key to that note.

Factory Presets

- BassToy
- CopyCatDelay
- Delayed 3rd and 5th
- Emaj 3rd+
- Guitar Toy
- Octave Long Delay
- Storyteller
- The Thief
- Third Dreaming I
- Try EEEEEEEE
- Wyld Stallions

H910 H949

This effect emulates the sound and functionality of Eventide's legendary [H910](#) and [H949](#) Harmonizer™ effects units. The H910 Harmonizer was the world's first real-time pro-audio pitch changer and

introduced the word “glitching” to the pro-audio vocabulary. The H949 was the world’s first de-glitched Harmonizer. Unlike the Diatonic pitch shifters, pitch shifting is in the feedback loop allowing for arpeggiated repeats.

Note

For the purists in our audience, you may remember that the H910 and H949 were mono in, stereo out devices. In other words, they featured a single pitch shifter with independently adjusted delays. To best emulate these vintage boxes, we recommend that you set either Pitch A or Pitch B to unison (1.00) and use that output for feedback without pitch change.

- Mix: Wet/dry mixer, 100% is all wet signal.
- Pitch A/Pitch B Mix: Controls the ratio of the level of Pitch A to Pitch B.
- Pitch Shift Up A: Controls the amount of pitch shift for voice A expressed as a ratio.
- Pitch Shift Down B: Controls the amount of pitch shift for voice B expressed as a ratio.
- Delay A: Controls the amount of time delay of the A pitch-shifted output. With Tempo Sync OFF, delay is displayed in ms. With Tempo Sync ON, delay can be sync'd to the tempo and is displayed as a rhythmic sub-division of the tempo beat value.
- Delay B: Controls the amount of time delay of the B pitch-shifted output. With Tempo Sync OFF, delay is displayed in ms. With Tempo Sync ON, delay can be sync'd to the tempo and is displayed as a rhythmic sub-division of the tempo beat value.
- Splice Type: Selects the type of Harmonizer emulated:
 - H910: The H910 was just a tiny bit unstable. And it showed. The H910’s iconic, flickering display was the first ‘digital readout’ to appear in many studios. And that flickering readout belied a secret – the H910 was inherently ‘jittery’. The H910’s master clock wasn’t crystal-based but, instead, it was a tuned LC (inductor/capacitor) oscillator. The result is that the system was not locked to a specific frequency and the entire system’s clocking would drift slightly, slowly and unpredictably. In fact, all of the oscillators in the H910 are of the ‘free-running’ sort and this randomness adds to the sound (and the fun). This Algorithm’s pitch change splicing method is the same as the hardware’s – the glitch is back!
 - H949-1: Algorithm 1 may cause glitches with increasing frequency as the pitch ratio deviates from 1:1, and is generally more appropriate for smaller pitch ratios.

- H949-2: Algorithm 2 uses an intelligent splicing Algorithm that greatly reduces glitching, but will add varying degrees of coloration to the signal, and is more suitable for extreme pitch ratios.
- Modern: The Modern pitch shifting Algorithm takes advantage of its powerful DSP to further reduce glitching.

Each of these Algorithms has a distinct quality and, when combined with various amounts of delay and feedback, offers a broad pallet of pitch-shifting effects.

- Pitch Coarse/Fine Control: Selects the type of pitch ratio control for Pitch A and Pitch B parameters:
 - Normal allows continuous control as a pitch ratio.
 - Micro allows for fine adjustments around Unison.
 - Chromatic allows you to select intervals equal to the 12 note per octave scale.
- Pitch A Feedback: Controls the amount of feedback for Delay A.
- Pitch B Feedback: Controls the amount of feedback for Delay B.

Performance Parameters

- REPEAT: Press-and-hold for infinite repeat.

Factory Presets

- 1984Legs
- 1984Panama
- 3 Octave Range
- 949 Chorus
- Backing Vocal
- Ballerina
- Bum-Ba-Dum
- ChnelVocals1
- Country Slap
- Dly1
- Dly2
- DlyDotSweet
- DlyOctave
- Echoes of 910 Past
- Fat H910
- GuitBassChorus
- Guitchnel
- Insanity Build
- Photon Beam
- Powerchord
- Rising Swim
- Shatter
- Slap
- Spicy Spring
- VoxDly
- WomenInLove

HarModulator

HarModulator combines twin chromatic pitch shifters with modulation to deliver an extremely wide range of effects from the subtle to the insane. Chromatic pitch shifters allow you to set the pitch ratio of each of the voices in semi-tone intervals (12 steps per octave). HarModulator features a six octave range (three up, three down). To get a sense of how to use the modulation function, it's best to start simply by

setting both Pitch A and Pitch B to UNISON, the delays to minimum, and feedback to 0. Now use the Mod Depth control to set the amount of pitch modulation and the Mod Speed control to adjust the modulation rate. Turn selecting different modulation shapes and sources. Note that you can select ENVELOPE as a source and use the dynamics of your playing to drive the modulation.

- Mix: Wet/dry mixer, 100% is all wet signal.
- Pitch A/Pitch B Mix: Controls the ratio of the level of Pitch A to Pitch B.
- Pitch Shift A: Selects the pitch shift interval in semitone increments from down three octaves to up three octaves.
- Pitch Shift B: Selects the pitch shift interval in semitone increments from down three octaves to up three octaves.
- Delay A: Controls the amount of time delay of the A pitch shifted output. With Tempo OFF, delay is displayed in ms. With Tempo Sync ON, delay can be sync'd to the tempo and is displayed as a rhythmic sub-division of the tempo beat value.
- Delay B: Controls the amount of time delay of the B pitch shifted output. With Tempo Sync OFF, delay is displayed in ms. With Tempo Sync ON, delay can be sync'd to the tempo and is displayed as a rhythmic sub-division of the tempo beat value.
- Modulation Depth: Controls the amount (or depth) of pitch modulation displayed in cents over a four octave range (two octaves down, two octaves up). Fine control for micro-pitch modulation is available and displayed in cents, ranging from -30 to +30 cents. When the modulation is a positive value the two voices will modulate in sync with each other; when the value is negative they will modulate out of sync.
- Modulation Rate: Controls the modulation rate. Note: If Envelope is selected as the Mod Shape, then modulation is driven by the amplitude of the audio input and Modulation Rate becomes a Sensitivity control.
- Modulation Shape: Selects the modulation shape. Select Envelope and your playing will drive the pitch modulation.
- Feedback: Controls the amount of feedback for Delays A and B.

Performance Parameters

- FLEX: Shifts both voices up one octave.

Factory Presets

- Bass Min Maj Mod
- Lightside Darkside
- Planet Obelisk
- BassGuitSolo
- Munchkin Whales
- Psycho Waiting
- Chromatic Delay
- One Finger Power
- Trance Octaves
- Elec12String Roo
- Photon Pistol
- VaiBallerina
- Foreboding

HarPeggiator

HarPeggiator creates dual 16-step arpeggios that combine three elements:

1. Dual 16-step pitch-shift sequencer
2. Dual 16-step rhythm sequencer
3. Dual 16-step effect sequencer

HarPeggiator lets you choose from a list of pre-programmed sequences for pitch, rhythm and effect. Using the many possible combinations gives you quite a bit of creative control. That writ, it's important to understand the underlying concepts or you're likely to spend quite some time scratching your head.

First off, we suggest that you experiment with only one voice (e.g. A) and the pitch sequence only. To do so, turn OFF the rhythm and effect controls. This is important because, by definition, for many rhythms not every step in the sequence is played. For example, you could select a rhythm that divides the 16 steps into four bars of quarter notes and only sounds the first step (note) of each bar. As a result, although the pitch sequence is 16 steps long, only four notes will sound. Also, use the Length control to set an appropriate length for each step so that you can clearly hear the pitch at each step.

The Pitch Sequence controls select one of 27 pitch sequences for A/B. These are selectable presets numbered from 01 to 26 plus a random sequence. Set to minimum to turn off the pitch effect.

For the majority of pitch sequences each step is a fixed pitch. However, the H90 has the ability to glide the pitch within any step. This feature is used in several of the sequences. The last sequence is a random sequence of pitches.

When selecting pitch sequences, it is best to first turn OFF both Rhythm and Effects sequences so that the pitch sequence is unaffected by these parameters. As always, your ears are the best judge of what works.

The first several pitch sequences are fairly straightforward. Here's a general description of each of these sequences:

1. All steps are one octave up.
2. All steps are one octave down.
3. All steps are a fifth up.
4. All steps are a fourth down.
5. Unison and one octave down.
6. One octave down, unison, one octave up, two octaves up.
7. Two octaves down, one octave down, unison, one octave up.
8. One octave down, unison, one octave up, 2 octaves up.
9. Unison, one octave up, unison, one octave up.
10. Unison, one octave up, unison, one octave up, etc.
11. Unison and fifth up.
12. One octave down climbing to unison.
13. Unison, fourth down, one octave down, two octaves down, unison, one octave up.
14. Starts at two octaves down, swoops up to unison and at the 13th step jumps up one octave and ends at unison.
15. Mostly up one octave with a short swoop to unison in the middle, back to an octave up and ending by swooping to unison.
16. Starts at unison, swoops down two octaves, makes a couple of jumps up one octave and ends on unison.
17. Starts at unison, swoops down one octave, jumps back to unison, brief jump up one octave, brief jump to up a fifth and ends on unison.
18. Four quick jumps up one fifth, swooping back down to unison.
19. Swoops from unison up one octave and does it twice.
20. Swoops from up one octave down to unison and does it twice.
21. Starts at unison steps up one octave and steps back down to unison.
22. Staggers its way from unison to up one octave.
23. Similar to 22.
24. Swoops up from unison to one octave up and does it four times.
25. Jumps between unison and octaves and fifths and fourths up and down.
26. Similar to 25.

For those who find the above description less than satisfying the following tables may help. In these tables, the 26 sequences are labeled at the column heads and, for each sequence, the 16 steps are listed vertically. Pitch sequences marked with an asterisk glide the pitch within a step in the sequence and an arrow indicates the step in the sequence that glides and the direction of the glide.

Intervals are indicated as follows:

- 1oct = one octave
- 2oct = two octaves
- M2 = major second
- m2 = minor second
- M3 = major third
- m3 = minor third
- P4 = perfect fourth
- d5 = diminished fifth
- P5 = perfect fifth
- M6 = major sixth
- m6 = minor sixth
- M7 = major seventh
- m7 = minor seventh

Pitch Sequences 1 - 7

	1	2	3	4	5	6	7
1	+1oct	-1oct	+P5	-P4	unison	-1oct	-2oct
2	+1oct	-1oct	+P5	-P4	unison	-1oct	-2oct
3	+1oct	-1oct	+P5	-P4	unison	-1oct	-2oct
4	+1oct	-1oct	+P5	-P4	-1oct	-1oct	-2oct
5	+1oct	-1oct	+P5	-P4	unison	Unison	-1oct
6	+1oct	-1oct	+P5	-P4	unison	Unison	-1oct
7	+1oct	-1oct	+P5	-P4	unison	Unison	-1oct
8	+1oct	-1oct	+P5	-P4	-1oct	Unison	-1oct
9	+1oct	-1oct	+P5	-P4	unison	+1oct	unison
10	+1oct	-1oct	+P5	-P4	unison	+1oct	unison

11	+1oct	-1oct	+P5	-P4	unison	+1oct	unison
12	+1oct	-1oct	+P5	-P4	-1oct	+1oct	unison
13	+1oct	-1oct	+P5	-P4	unison	+2oct	+1oct
14	+1oct	-1oct	+P5	-P4	unison	+2oct	+1oct
15	+1oct	-1oct	+P5	-P4	unison	+2oct	+1oct
16	+1oct	-1oct	+P5	-P4	unison	+2oct	+1oct

Pitch Sequences 8 – 14

	8	9	10*	11	12*	13*	14*
1	-1oct	Unison	unison	unison	-1oct ↑	unison ↓	-2oct ↑
2	unison	Unison	+1oct	unison	-m7 ↑	-P4 ↓	-1oct ↑
3	+1oct	+1oct	+1oct	unison	-m6 ↑	-1oct ↓	-P5 ↑
4	+2oct	+1oct	unison	unison	-P5 ↑	-2oct	-m3 ↑
5	-1oct	+1oct	unison ↑	unison	-P4 ↑	Unison	unison
6	unison	+1oct	+1oct	unison	-m3 ↑	Unison	unison
7	+1oct	+1oct	unison	unison	-M2 ↑	Unison	unison
8	+2oct	Unison	+1oct	unison	-m2 ↑	Unison	unison
9	-1oct	Unison	+1oct	unison	unison	Unison	unison
10	unison	Unison	unison	unison	unison	Unison	unison
11	+1oct	+1oct	+1oct	unison	unison	Unison	unison
12	+2oct	+1oct	+1oct	+P5	unison	Unison	unison
13	-1oct	+1oct	unison	unison	unison	+1oct	-1oct ↑
14	unison	Unison	+1oct	+P5	unison	Unison	unison

15	+1oct	Unison	+1oct	unison	unison	Unison	unison
16	+2oct	Unison	+1oct	unison	unison	Unison	unison

Pitch Sequences 15 - 21

	15*	16*	17*	18*	19	20	21
1	+1oct	unison ↓	unison ↓	+P5 ↓	unison	+1oct	unison
2	+1oct	-m2 ↓	-d5 ↓	unison	+M2	+M7	+M2
3	+1oct	-M3 ↓	-1oct	unison	+M3	+M6	+m3
4	+1oct	-M6 ↓	-1oct	unison	+P4	+P5	+M3
5	+1oct	-P4oct ↓	unison	+P5 ↓	+P5	+P4	+P4
6	+1oct	-2oct	unison	unison	+M6	+M3	+P5
7	+1oct	unison	unison	unison	+M7	+M2	+M6
8	+1oct ↓	unison	unison	unison	+1oct	Unison	+M7
9	+1oct	+1oct	+1oct ↓	+P5 ↓	unison	+1oct	+1oct
10	+1oct	unison	+P5 ↓	unison	+M2	+M7	+M7
11	+1oct	unison	unison	unison	+M3	+M6	+M6
12	+1oct	+1oct	unison	unison	+P4	+P5	+P5
13	+1oct	unison	unison	+P5 ↓	+P5	+P4	+P4
14	+1oct ↓	unison	unison	unison	+M6	+M3	+M3
15	+m6 ↓	unison	unison	unison	+M7	+M2	+m3
16	+M3 ↓	unison	unison	unison	+1oct	Unison	+M2

Pitch Sequences 22 - 26

22	23	24*	25	26*
----	----	-----	----	-----

1	unison	unison	unison ↑	unison	-1oct
2	unison	unison	+P4	-1oct	Unison
3	+M2	+m3	+P5	unison	+P5
4	unison	unison	+1oct	+1oct	+P4
5	+M3	+P4	+m3	unison	-1oct
6	unison	unison	+P4	-P5	+1oct
7	+P4	+P4	+P5	unison	-P4
8	unison	+d5	+1oct	+P5	-P5
9	+P5	+P5	+m6 ↑	unison	Unison
10	unison	unison	+P4	-P4	-1oct
11	+M6	+P5	+P5	unison	Unison
12	unison	unison	+1oct	+P4	+P5
13	+M7	+m7	+m7	unison	+P4
14	unison	unison	+P4	-m3	Unison
15	+1oct	+1oct	+P5	unison	Unison
16	unison	unison	+1oct	+m3	-2oct ↑

- Mix: Wet/dry mixer, 100% is all wet signal.
- Arpeggiator A/Arpeggiator B Mix: Controls the ratio of arpeggiator A to arpeggiator B.
- Pitch Sequence A: See description and table above
- Pitch Sequence B: See description and table above
- Rhythm A: These controls select the rhythm/groove sequence for A/B. The rhythm sequences are a set of 21 selectable presets. The pitch sequences are numbered from 01 to 20, plus an additional random rhythm. Set the control to Off to turn off the rhythm sequence. With the rhythm sequence turned Off, all sixteen steps of the sequence are played at full amplitude.

- Rhythm B: See the description for Rhythm A.
 - Dynamics (Attack/Release Time): Sets attack and release time for the dynamics of the Rhythm and Effects. When set to minimum (-10), the audio takes the entire step length to fade in; at mid-range (0), the audio is present for the entire step duration; and at maximum (10), the audio is present for only 1/10th of the step's duration. Note: This control has no effect when both Rhythm and Effect knobs are set to Off.
 - Step Length: With Tempo Sync OFF, sets the length of each of the 16 steps in ms. With Tempo Sync ON, sets the length of each step relative to the tap tempo (length of note e.g. whole, quarter, etc.).
 - Effect A: HarPeggiator lets you apply a sequence of filter, fuzz and/or glitch effects to each note of the 16-step sequence. The effect sequences are a set of 25 selectable presets. The effects are indicated by effect type:
 - Filter 1-5
 - Fuzz 1-5
 - Glitch 1-5
 - All
- There are five filter effects, five fuzz effects and five glitch effects to choose from. Or, you can select one of four different types of random effect sequences:
- Random Filters
 - Random Fuzz
 - Random Glitches
 - Random All - a combination of filters, fuzz, and glitches.
 - Off
- Effect B: See the description for Effect A.

Performance Parameters

- RESTART: Restarts the sequence from the beginning.

Factory Presets

- BassWith Arps
- Fake Shredding
- LightEmUp
- Old Video Game
- BigChill
- Get Them Kids Moving
- Machines
- Rave Vocals
- BoilingSolo
- Hypernotes Arp
- Menace
- SpaceTrem
- Bubbles
- Intellivision
- Molten
- TremBot
- DownUp

MicroPitch

MicroPitch is a fine-resolution pitch shifter ideal for vocal doubling, tone fattening, and unique delays. With independent control of each pitch shifter's shift amount and delay time, plus feedback and modulation controls, MicroPitch makes it easy to create pristine chorusing effects, deep pitch dives, haunting echoes, and more.

- Mix: Relative level of the wet and dry signals.
- Pitch Mix: Controls the ratio of the level of Pitch A to Pitch B.
- Pitch A: Controls the amount of pitch shift up for voice A, from Unison to +50 cents.
- Pitch B: Controls the amount of pitch shift down for voice B, from Unison to -50 cents.
- Delay A: Controls the amount of time delay of the A pitch-shifted output. With Tempo Sync OFF, delay is displayed in ms. With Tempo Sync ON, delay can be sync'd to the tempo and is displayed as a rhythmic sub-division of the tempo beat value.
- Delay B: Controls the amount of time delay of the B pitch-shifted output. With Tempo Sync OFF, delay is displayed in ms. With Tempo Sync ON, delay can be sync'd to the tempo and is displayed as a rhythmic sub-division of the tempo beat value.
- Modulation Depth: Controls the amount (or depth) of pitch modulation around the current pitch for each voice. A value of 100 represents a bipolar full swing of the modulation from 0 cents to 2x Pitch. Lesser values scale proportionally.
- Mod Source:
 - -Env: Increased volume decreases the Pitch modulation.
 - LFO: Constant LFO modulation determined by the Mod Rate parameter.
 - +Env: Increased volume increases the Pitch modulation.
- Mod Rate: Controls the LFO rate when LFO is selected as the Mod Source. 0.1 to 10 Hz
- Mod Sens: Controls the sensitivity of the envelope follower when -Env or +Env is selected as the Mod Source.
- Feedback: Controls the amount of feedback for Delays A and B.
- Tone: Applies filtering to voice A and voice B.

Performance Parameters

- FLEX: Doubles the pitch shift amount of both voices.

Factory Presets

- BassChorus(es)
- Elevator Delays
- Spacey Springs
- Bottomless Drop
- H3000 MicroPitch
- Thick
- Chorus Room
- NiceChorus
- VibraChorus
- DarkEchoes
- Slap My Echo

Octaver

Octavers traditionally use analog techniques to track the pitch of the input audio signal and synthesize a signal whose musical tone is an octave lower than the original. Octaver creates a pair of sub-harmonics, one an octave below the note that you're playing and the other two octaves below. It also adds an Octave Fuzz generator. The sub-harmonics can be filtered and the filters modulated by the input audio level.

Note: Octaver is a parallel (dual mono) rather than stereo effect.

- Mix: Wet/dry mixer, 100% is all wet signal.
- Sub-Harmonic Mix: Controls mix of 1st and 2nd sub-harmonics (A and B). Note that Inputs 1 and Inputs 2 are not mixed.
- Filter Center Frequency A: Controls the center frequency of the resonant filter for A.
- Filter Center Frequency B: Controls the center frequency of the resonant filter for B.
- Filter Resonance A: Controls filter resonance for A. Note: After adjusting the filter's center frequency and resonance, you may want to try modulating the filter.
- Filter Resonance B: Controls filter resonance for B.
- Envelope Filter Shift: Octaver allows your playing to vary the center frequency of the filters. This control adjusts the degree to which the input signal's envelop shifts the filter's center frequency.
- Envelope Sensitivity: Controls the sensitivity of the frequency sweeps to the input signal level.
- Distortion: Controls the amount of distortion (fuzz).
- Octave-Fuzz Mix: Controls the mix of octaves and fuzz.

Factory Presets

- Bass Voweler Growl
- Classic Octaver
- Crab Bass
- Drty Vocals
- Massivuzz
- NazzyBass
- OctoFuzzver
- ThroatyBass
- WahElectronique

PitchFlex

PitchFlex is designed to be used 'live' with either an Expression Pedal, the on board HotKnob, or the Flex switch. Using the Heel and Toe controls you can set the pitch shift of two voices at each end of travel of the Expression Pedal. Turning these controls 'OFF' results in no pitch change. The other controls allow you to tailor the 'sweep' by controlling its speed and shape.

- Mix: Wet/dry mixer, 100% is all wet signal.
- Pitch Mix: Controls the ratio of the level of Pitch A to Pitch B.
- Manual Shift: Sweeps the pitch from the 'heel' to 'toe' value. Map an expression pedal to this parameter and adjust it to perform the sweep.
- Heel A/B: Sets pitch shift of the voice in the heel position. When 'OFF' is selected, the voice is muted at the heel position and the pitch is set to unison.
- Toe A/B: Sets pitch shift of the voice in the toe position. When 'OFF' is selected, the A pitch shifter is disabled at the toe position and toe is treated as unison.
- Heel-to-toe glissando: This parameter is for use when using the Flex performance parameter, or an Auxiliary Switch to control the pitch change effect for voices A and B. Sets the time to move from 'heel' to 'toe'. With Tempo Sync ON the maximum is $\frac{1}{2}$ note.
- Toe-to-heel glissando: Same as above, but set the time to move from 'toe' to 'heel'.
- Glissando Shape: Controls the 'shape' that the pitch modulation follows when using the Flex Switch. If set to Negative values, the pitch goes slowly towards 'toe' and quickly transitions to 'heel', Positive is the other way around, and 0 means the pitch shifts up and down linearly.
- Low Pass Filter: A low pass filter to 'darken' the effect.

Performance Parameters

- Flex: Sweep the pitch shift from 'toe' to 'heel' position.

Factory Presets

- | | | | |
|---------------------|----------------------|---------------------|--------------------------------------|
| • Flex Harmony +2nd | • Flex Harmony +FL | • Octave Flexswitch | • Pitch Flex -2Oct |
| • Flex Harmony +3rd | • Flex Harmony -1oct | • Pitch Flex +1oct | • Pitch Flex -2nd |
| • Flex Harmony +4th | • Flex Harmony -4th | • Pitch Flex +2oct | • Pitch Flex -4th |
| • Flex Harmony +5th | • Flex Harmony -5th | • Pitch Flex -1oct | • Pitch Flex Unison & +5th +2nd +6th |

PolyFlex

A fully polyphonic version of our classic, 2-voice PitchFlex algorithm, with a few added bonuses. Bend a chord into a new harmony, perform polyphonic dive bombs, or achieve pedal steel like tones. Fully equipped with detune, freeze, and individual controls for flexing either voice. The brand new Auto Engage feature allows you to preserve your dry signal while you are not flexing.

- Mix: Wet/dry mixer, 100% is all wet signal.
- Detune: A detune amount applied to both the base shift amount and the Flex amount, from -50 cents to 50 cents.
- Flex Time: How long it takes to get from the Shift interval to the Flex interval from 0 to 2 seconds.
- Return Time: How long it takes to return to the Shift interval from the Flex interval from 0 to 2 seconds.
- Auto Engage: When on, the algorithm is bypassed until the Flex is engaged, or Manual Flex is above 0. This will be triggered by any of the available ways to Flex.
- Auto Engage Hold Time: If Auto Engage is on, this parameter allows the pitch shifted effect to remain on for a period of time from 0 to 1 second. This can help the auto engage parameter from disengaging abruptly.

The following parameters are available for both pitch A and B:

- Level: Adjusts the level of the pitch shifted voice.
- Shift: The base pitch shift amount specified in musical intervals for each voice of shifting. -2 Oct, -P12, -P11, -Oct, -M7, -m7, -M6, -m6, -P5, -Tri, -P4, -M3, -m3, -M2, -m2, Uni, m2, M2, m3, M3, P4, Tri, P5, m6, M6, m7, M7, Oct, P11, P12, 2 Oct
- Flex: The pitch shift amount to dive/bend to. -2 Oct, -P12, -P11, -Oct, -M7, -m7, -M6, -m6, -P5, -Tri, -P4, -M3, -m3, -M2, -m2, Uni, m2, M2, m3, M3, P4, Tri, P5, m6, M6, m7, M7, Oct, P11, P12, 2 Oct

- Manual Flex: Sweeps the pitch from the 'Shift' to 'Flex' value. Map an expression pedal to this parameter and adjust it to perform the sweep.
- Pan: Moves the pitch shifted voice left or right in the stereo field.

Performance Parameters

- FLEX (A/B) - Momentary or latching performance parameter to activate the pitch bend/dive for each shifted voice. Current pitch shift is determined by whichever control was touched last (this or the manual flex knob/external controller)
- Flex Dual - Momentary or latching performance parameter to bend/dive both voices at the same time. Current pitch shift is determined by whichever control was touched last (this or the manual flex knob/external controller)
- FREEZE: Freezes the pitch-shifting sound for pad like textures. The dry signal is still passed through. Note that if Auto Engage is On, you won't hear the frozen signal when you are not flexing.

Polyphony

A low-latency, high quality polyphonic pitch shifter capable of so much more. Making use of Eventide's new SIFT (Spectral Instantaneous Frequency Tracking) technology, this algorithm shifts any chord or note you throw at it with zero tracking errors, all while preserving the tone of your guitar. With this algorithm you can go from creating massive, organ-like chords and harmonies to out of this world special effects. The input signal is sent through the polyphonic pitch shifting engine which outputs two voices of shifted output - each with their own interval and detune controls. Included in the pitch shifting engine are the Auto EQ filters which help preserve the tone of the input signal. These filters are automatically adjusted based on the shifting interval to give the shifted voices as natural of a sound as possible, and the amount of filtering applied is adjustable. These voices are then fed to individual delays with independent time and feedback controls. The pitch shifting engine can be placed either inside or outside of this delay feedback loop, allowing you to create unique rising or sinking chorus sounds, and crystals type effects. Finally, the two voices can be independently panned when the output of the pedal is connected in stereo. As a cherry on top the latching or momentary Freeze performance switch allows you to infinitely sustain the pitch shifted sound while passing through the dry signal to create pad textures that you can play over.

- Mix: Wet/dry mixer, 100% is all wet signal.
- Inst Type: Tunes the underlying pitch shifting Algorithm for either pitched or percussive instruments.

! Tip

The Percussive instrument mode is designed to prioritize preserving the transients and tone of the original signal while also having less latency. For applications where you would like to re-tune a guitar or bass (Mix is 100% wet) Percussive mode may work better for small shift intervals. For larger intervals the quality of the shifted sound will be better in the Pitched mode.

- Feedback Sw: Places the pitch shifter inside or outside of the feedback path.

Because the pitch shifting is a mono in, multi out effect, the feedback paths of the shifted voices are summed together first before being fed back to the pitch shifter. This causes the feedback to slowly fade towards the center even if the voices are panned hard left/right when the pitch shifter is inside the feedback path. There is also a gentle lowpass filter in this mode to help remove some of the very very high annoying stuff that can happen when shifting up over and over again.

Note: Feedback amounts may have different effects in one mode vs the other.

- Auto EQ: Determines the amount of automatic EQ that is applied to the shifted voices to help them sound more natural. When shifting down the auto eq brightens things up to try and preserve the transients of the original signal. When shifting up, the auto eq smooths out harsh squeaky sounds. The EQ is automatically adjusted based on the amount of shift applied in either direction. A default setting of 10 is recommended.

The following parameters are available for both pitch A and B:

- Level: Adjusts the volume of the pitch.
- Shift: -2 Oct, -P12, -P11, -Oct, -M7, -m7, -M6, -m6, -P5, -Tri, -P4, -M3, -m3, -M2, -m2, Uni, m2, M2, m3, M3, P4, Tri, P5, m6, M6, m7, M7, Oct, P11, P12, 2 Oct
- Detune: The amount of detuning, from -50 cents to 50 cents.
- Delay: The amount of delay, from 0 ms to 2 s.
- Feedback: The amount of feedback for each voice. Behaves differently depending on how Feedback Sw is set.
- Pan: Moves the pitch left or right in the stereo field.

Performance Parameters

- FREEZE: Freezes the pitch-shifting sound for pad like textures. The dry signal is still passed through.

Factory Presets

- 12 Stringy
- Bass Poly Octaver
- Diamond Stuff
- Hesitate
- Jazz Vibes
- Key Like
- Low Down
- Poly Chorus
- PolyOctaver
- PolyRhythm
- Polyphony
- The Show

Prism Shift

Open the door to never before heard polyphonic effects. PrismShift leverages sophisticated polyphonic pitch tracking and Eventide's new low-latency polyphonic pitch shifting engine to generate 3 arpeggiated voices (Low, Mid, High)—all from a single chord. The detected chord intervals are separated, staggered and pitch shifted to create 4 different arpeggio types: rising, falling, rising/falling, and falling/rising. The arpeggios span up to 3 octaves, and can use 6 different groups of intervals. Turn up the feedback and glide between intervals to create a multitude of new effects.

- Mix: Wet/dry mixer, 100% is all wet signal.
- Arp Type: Sets which type of Arpeggio to use. The choices are:
 - Rising
 - Falling
 - Falling/Rising
 - Rising/Falling
- Step Length: Time between successive notes in the arpeggio
- Shift: Shift ratio for the low/high voices. E.g., if -1oct + 1oct is used the high voice will be shifted up an octave and the low voice will be shifted down an octave. The choices are:
 - -1oct + 1oct
 - -P4 + P5
 - -P5 + P4
 - +1oct + 2oct
 - +P5 + P12
 - +P4 + P11
- Arp Order: Order of the voices in the arpeggio. E.g., if the Arp Type is rising and the Arp Order is L-M-H, then the arpeggio will rise from low-to-high frequencies. However, if the Arp Order is H-M-L,

then the high voice will rise, following by a rising mid voice, and then a rising low voice. This creates a simultaneous ascending while descending sort of effect. The choices are:

- L-M-H
- L-H-M
- M-L-H
- M-H-L
- H-L-M
- H-M-L
- Auto Eq: An Eq for the pitch shifted voices. A default setting of 10 is recommended.

The following controls are available for all three voices:

- Gain: A gain control for the specific voice.
- Feedback: A feedback control for the specific voice.
- Feed Tap: Feedback tap. When set to Total, each arp will complete a full cycle before feeding back. Sequence 1 and Sequence 2 cause the feedback to happen before the arpeggio is complete leading to interesting repeating patterns. Random uses a random feedback tap. The options are:
 - Total
 - Sequence 1
 - Sequence 2
 - Random
- Spread: Controls the stereo spread of the voices. When set to -1 the Low voice is panned hard left, the mid voice is panned center, and the high voice is panned hard right. When set to +1 this is reversed. Intermediate values morph between these two extremes.
- Slew Time: A slew on the Shift control. A large value will cause changes to the Shift parameter to glissando.

Performance Parameters

- Freeze (latching): Freezes the “High” and “Low” pitch shifted voices, the “Mid” voice (which is not pitch shifted) is not frozen.
- Shift (M): Moves the current value of the shift knob 1 position clockwise, wrapping if necessary.
 - -1oct +1oct shifts to -P4 +P5
 - -P4 +P5 shifts to -P5 +P4
 - -P5 +P4 shifts to -1 +1oct
 - +1oct +2oct shifts to +P5 +P12
 - +P5 +P12 shifts to +P4 +P11
 - +P4 +P11 shifts to +1oct +2oct

Factory Presets

- All A Dream
- End Of All
- Ocean Waves
- Suspense
- Arp Dancer
- Glimmer Verb
- Prism Ballet
- Unraveling
- Deep Echoes
- Glitter
- Prism Shift
- Water Reflections
- Diamond Shine
- Hallowed Grounds
- Sequential Chimes

Quadravox

Quadravox is similar to Diatonic but delivers up to four pitch shifted voices (A, B, C, D) instead of two. You can select the interval of each voice independently. You can also turn off any of the voices.

Note that it is possible to select OFF for all four voices. If you do, and the Mix knob is set 100% Wet, there will be no output signal.

- Mix: Wet/dry mixer, 100% is all wet signal.
- Pitch A and C/Pitch B and D Mix: Controls the ratio of level Pitch A+C to Pitch B+D. With the knob set full counter-clockwise, PitchA + PitchC are set to equal level. Full clock-wise, sets Pitch B + Pitch D to equal levels. The ratio of level of Pitch A to Pitch C and of Pitch B to Pitch D are fixed at equal levels and cannot be changed.
- Pitch Shift A: Selects the harmonic interval (pitch shift) for Pitch A. Set to minimum to turn OFF voice A.
- Pitch Shift B: Selects the harmonic interval (pitch shift) for Pitch B. Set to minimum to turn OFF voice B.
- Delay D: Quadravox's delay controls work differently from those in the other effects. Quadravox's four delays are not independently variable. Instead, they are staggered with A having the shortest delay, B longer than A, C longer than B and D the longest. The Delay D control is used to set the last delay. With Tempo OFF, delay is displayed in ms. With Tempo Sync ON, delay can be sync'd to the tempo and is displayed as a rhythmic sub-division of the tempo beat value.
- Delay Grouping: Select the grouping of the four delays (A, B, C, D). The delays can be evenly spaced or spread out.
- Key: Selects the key.

Scale: Selects the scale. The supported scales are:

- - Major
 - Mixolydian
 - Whole Tone
 - Minor
 - Locrian
 - Enigmatic
 - Dorian
 - Harmonic Minor
 - Neapolitan
 - Phrygian
 - Melodic Minor
 - Hungarian
 - Lydian

- Pitch Shift C: Selects the harmonic interval (pitch shift) for Pitch C. Set to minimum to turn OFF voice C.

- Pitch Shift D: Selects the harmonic interval (pitch shift) for Pitch D. Set to minimum to turn OFF voice D.

- Quantization - Quantizes the notes that are not in the selected key scale to fit within the selected key and scale.

Performance Parameters

- LEARN MODE: Press and hold the Learn switch while playing a note and the H90 will set the key to that note.

Factory Presets

- Anthem
- Banjo Strummer
- Good Morning Sun
- GuitarHarp
- Heavy Quad Octav
- If It's Baroque
- MoodSwitch
- PitchDrama
- Teenage Wasteland

Resonator

Resonator staggers 4 resonant comb filters to create ambient, arpeggiated, or reverberant sounds. Each comb filter can be tuned to ring out when you play the note selected by the respective 'Note' knob. This

creates dynamic effects that react with more or less intensity based on the harmonic content of the input audio.

- **Mix:** Wet/dry mixer, 100% is all wet signal.
- **Length:** Total length of the delay line. This length is split into 8 subdivisions on which the comb filters can be staggered.
- **Rhythm:** Represents the rhythm pattern of the comb filters. Each digit indicates the subdivision on which a comb filter is positioned. “1.3.5.7” will sound like even quarter notes since the four comb filters are evenly spaced on the 1st, 3rd, 5th, and 7th subdivisions.
- **Feedback:** The feedback level of each of the comb filters. Feedback type 1 [FB1] maintains the pattern set by the rhythm knob, whereas feedback type 2 [FB2] degrades the pattern as it repeats.
- **Resonance:** Affects how intensely the comb filters resonate. The comb filters will ring out more intensely as the resonance increases in either the positive or negative direction. Resonance set to 0 will act as multi-tap delay without any additional resonant tones.
- **Reverb:** Controls the amount of reverb in the comb filter path.
- **Note 1:** Tunes the note values that trigger each respective comb filter. When resonance is positive, all integer multiples of this frequency will resonate. When the resonance is negative, only odd multiples of this frequency will resonate. These note values also affect the high and low pass filters surrounding each comb filter. When resonance is set to 0, these knobs can still be used to filter the delays.
- **Note 2:** Same as Note 1.
- **Note 3:** Same as Note 1.
- **Note 4:** Same as Note 1.

Factory Presets

- Andy Warhol On The Run
- Beecuz
- Cascade
- Cavern
- Clean Delay
- Dissonant Repeater
- Electrons
- Filtered Multitap
- Gumdrop
- Raag Malhar
- Reno
- ResoVerb
- Saverence
- Scary Chord
- Spelunking
- Submerged
- The Beautiful
- Thor’s Bells
- Tick Tock
- Transcendental Dolphin

Reverb

Blackhole

Blackhole is a reverb Algorithm on a truly galactic scale. Beginning life as a preset in the DSP4000, then later in the H8000, its lush sound and popularity encouraged us to feature it as one of the premier Algorithms in Eventide's Space guitar pedal. Its soft attack and lingering, harmonic tail cause it to really shine on guitars, strings, and pads, but those same qualities also allow it to transform a drum track into something other-worldly. Enjoy, and don't be afraid to turn the knobs.

- **Mix:** Determines the relative level of the wet and dry signals.
- **Gravity:** The Blackhole's equivalent of decay time. On the right-hand side, the Gravity control sweeps through its forward reverb range from a very dense decay to a very long and smooth decay. On the left hand side, the Gravity control is in its inverse mode and sweeps through a range of reverse reverb-like settings.
- **Size:** Determines the size of the reverb. This can range from cartoonishly small to cosmically epic.
- **Pre Delay:** Sets the amount of delay before the reverb section. When Tempo Sync is off, this ranges from 0 ms to 2000 ms. When Tempo Sync is on, this is set in subdivisions of the tempo.
- **Low Level:** Controls the level of low frequencies in the reverb tail using a shelving filter with a corner frequency of 350 Hz.
- **High Level:** Controls the level of high frequencies in the reverb tail using a shelving filter with a corner frequency of 2000 Hz.
- **Mod Depth:** Sets the modulation depth in the reverb tail. This can be a subtle control, which nevertheless can reduce ringing in the reverb tail and add some motion to the sound. This parameter is frozen while Feedback is set to Infinite or Freeze.
- **Mod Rate:** Sets the relative speed of the modulation in the reverb tail. Subtle but useful.
- **Feedback:** Controls the feedback around the entire reverberation structure, for even larger sounds. Turning clockwise to Infinite will allow for infinite reverberation time, while still letting incoming signal into the reverberation structure. Turning further clockwise to Freeze sets the reverberation time to infinite, and does not allow incoming signal into the reverberation structure.
- **Resonance:** Controls the resonance of the Low-level and High-level filters. When the filters are set to 0, this does nothing, but when they are active, it can create a much more filtered sound. But be careful, extreme settings will increase the chances of overloads.

Factory Presets

- AmeBlackDrone
- Blackhole
- Centaurus
- Cigarroos
- Dark Matter
- Dogstar
- FishHole
- Hey Honey
- Nebula
- Neutrino
- Pulsar
- Pulsar II
- StarCrater
- Train Tracks
- Transfigured
- Vortexting

DualVerb

DualVerb combines two different high quality studio reverbs (A and B) in parallel, with independent controls for decay, size, pre-delay, and tone. Use A/B Mix to mix between both for rich, dense stereo reverberation, or to smoothly transition between two entirely different reverb sounds.

- Mix: Determines the relative level of the wet and dry signals.
- A/B Mix: Determines the input level of the A and B reverbs. When Decay is Frozen, A/B Mix is post-reverb (normally it is pre-reverb). With stereo outputs, you may turn this parameter fully clockwise for dual mono reverbs (A on left, B on right). A mono input will be sent to each reverb, while a stereo input will send input 1 to reverb A, and input 2 to reverb B.
- Resonance: Adjusts the resonance of reverb A and B's Tone controls. This does not affect the sound if Tone is set to 0.
- Size: Determines the size of both reverbs A and B. Many different size combinations are possible with this one knob.

The following parameters are available for both Reverb A and B:

- Decay: Sets the decay time for the reverb. When Tempo Sync is off, this ranges from 0 s to 50 s. When Tempo Sync is on, this is set in subdivisions of the tempo. Turning clockwise to Infinite will allow for infinite reverberation time, while still letting incoming signal into the reverberation structure. Turning further clockwise to Freeze sets the reverberation time to infinite, and does not allow incoming signal into the reverberation structure.
- Predelay A: Sets the amount of delay before the reverb. When Tempo Sync is off, this ranges from 0 to 900 ms. When Tempo Sync is on, this is set in subdivisions of the tempo.
- Tone: Tone control for the reverb. Negative values bring out the lows, while positive values bring out the highs.

Factory Presets

- DualVerb
- Echo Verbs
- Empty Streets
- HotSw Freeze
- SpaceGallop

DynaVerb

DynaVerb couples an Eventide Eclipse reverb with a model of the [Eventide Omnipressor®](#) to create an adaptable dynamics reverb. The Omnipressor is capable of all types of dynamics processing from gating, expansion, compression, limiting, and even its signature ‘dynamic reversal,’ where loud signals are squashed, but quiet signals are amplified. In DynaVerb, the Omnipressor can dynamically control the output of a reverberator based on, either the input signal for maximum control, the reverb output for incredible chaos, or any mixture of the two. As an added bonus DynaVerb can also be used as a standalone Omnipressor by setting Decay to zero.

- Mix: Wet/dry mixer, 100% is all wet signal
- Decay: Decay in seconds or note-based with Tempo Sync ON. When decay is 0, this effect can be used as a standalone Omnipressor or gate.
- Size: Room size of reverb.
- Attack Time: Attack time of Omnipressor/gate in seconds.
- Low Band Shelving Level: Post reverb shelving boost/cut of low frequencies with cut-off at 350 Hz.
- High Band Shelving Level: Post reverb shelving boost/cut of high frequencies with cutoff at 2000 Hz.
- Compression/Expansion Ratio: Ratio control for the Omnipressor from traditional Gated sound, to expansion, then compression, then limiting and infinite ducking, then to negative ratios which result in dynamic reversal.
- Release Time: Release time for the Omnipressor/gate in seconds.
- Threshold: Threshold for the Omnipressor/gate.
- Sidechain: The mixer to the sidechain input (gain control signal). When set to minimum, the gain curve is derived from the input only. At maximum, it is a feedback dynamics unit with gain derived from the reverb output. In Omnipressor Mode, this simply lets you fade between a feedforward (FF) and feedback (FB) compressor/expander/gate/etc.

Factory Presets

- Adapt-A-Room
- Ames Duck
- DynaVerb
- Phil Mcavity
- Radio Static
- Tap-n-Trem

Hall

Hall simulates the sound of large enclosed spaces. Hall offers flexible control of a 3-band crossover reverb network. There are independent decay controls for the low and high band, as well as independent level controls for low, mid, and high band. This is the go-to Algorithm for beautiful realistic spaces or for reverb sounds just beyond the boundary of realism.

- Mix: Determines the relative level of the wet and dry signals.
- Decay: Master decay in seconds or note-based with Tempo Sync ON.
- Size: Hall size.
- Pre Delay: pre-delay in milliseconds or note-based with Tempo Sync ON.
- Low Band Reverb Level: boost/cut of LOW reverb with cut-off at 300 Hz, -100 effectively cuts all of the low band reverb.
- High Band Reverb Level: boost/cut of HIGH reverb with cut-off at 1500 Hz, -100 effectively cuts all of the high band reverb.
- Low Band Decay: Decay of low band reverb, scales the Decay time.
- High Band Decay: Decay of high band reverb, scales the Decay time.
- Modulation Level: Increases random modulation of reverb tails.
- Mid Band Reverb Level: Boost/cut of mid reverb (between 300 and 1500 Hz), -100 effectively cuts all of the mid band reverb.

Factory Presets

- 1985 Damage
- Amedeo-Slap
- Carnegie Hall
- Cave Space
- Corridors
- Dark Cave
- DelayedPlate
- Dish Delay
- Doom Chamber
- Earth Hall
- Hall
- Hi Fi
- Kubrix
- Panoramance
- Phantom Verb
- Tornadian
- Vapor Trail

MangledVerb

We recognize the universe is a chaotic and often violent place, so in the spirit of the yin and yang of it all, we're proud to present MangledVerb. Technically, MangledVerb feeds a non-standard stereo reverb into distortion, but sonically, it can range from the light friction of a bow scraping a cello string to obnoxious mayhem. Judicious use of the Wobble and Overdrive is approved, and try setting small ranges for Size and Decay for some surprising sounds.

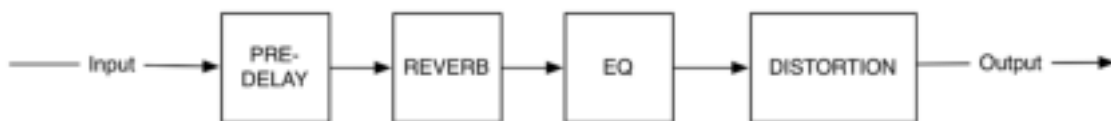

Fig. 5 MangledVerb's signal flow diagram

- Mix: Wet/dry mix, where 100 is an all wet signal. It has a special nonlinear taper which puts most of the knob travel in the most usable range. Note: the Mix control is not accounted for in the signal flow diagram.
- Decay: Length of reverb decay scaled from 1-100. Less decay will take away reverb attack. Specifically, higher values (greater than 70) will impart traditional reverb tails, while lower values (less than 70) can result in reverse reverb sounds with more build up.
- Size: Determines the size of the reverb. To use MangledVerb as a distortion type effect, try setting this below 15.
- Pre Delay: Sets the amount of delay before the reverb section. When tempo mode is off, this range is from 0 to 1500 milliseconds. When Tempo Sync is set to ON, Pre-Delay is set in beat divisions of the tempo. The Pre-Delay control affects the Pre-Delay Block in the signal flow diagram.
- Low Band Level: Boost/Cut of the low frequencies before the distortion section of the signal path.
- Mid Band Level: Boost/Cut of the middle frequencies before the distortion section of the signal path.

- High Band Level: Boost/Cut of the high frequencies before the distortion section of the signal path.
- Softclip/Overdrive Type: Use this control to choose from two types of distortions (soft-clipping and overdrive) and set their gain/drive amount. The first half of the knob controls the Softclip gain level from 1 to 100. Passing 100 in Softclip switches the distortion type to Overdrive with a gain/drive range of 1 to 100. The gain/drive amounts in the distortion section were designed so that the transition from Softclip to Overdrive would be as smooth as possible.
- Distortion Output Level: Controls the output level of the distortion section from -18 dB to +6 dB. Adding gain/drive in the distortion section via the Softclip/Overdrive control will naturally add level, so use this control accordingly. Note: The Level control knob is different than the Out Gain. The Out Gain sets the output level of the entire Algorithm (including the dry signal path).
- Wobble: A modulation rate that does some spooky detuning.

Factory Presets

- DoomDrive
- DriveDoom
- Fluffer
- MangledVerb
- MangledVern
- Oblivion
- Revunched
- Sanskritual1
- ScreamWarp

ModEchoVerb

ModEchoVerb is based on a popular reverb structure from the Eventide H8000 that brought about such presets as Echospace Of God and Glorious Flange Canyon. It feeds the output of an infinite reverb into an infinite feedback delay and slathers on an extra helping of modulation. The modulation choices are H3000-type swept verb, flanging, or chorusing. ModEchoVerb is incredibly versatile and can be used as a standalone reverb, delay, chorus/flanger, or any combination of the three. Infinite and Freeze are available on the Decay knob. During Freeze the signal is rerouted to allow for parallel modulation/delay over the frozen section. Have fun.

- Mix: Wet/dry mixer, 100% is all wet signal.
- Decay: Decay in seconds or note based with Tempo Sync on. All the way right Infinite gives an infinite reverb/sustain.
- Size: From normal Hall type room sizes to huge canyon sounds with echoes.
- Echo: Post reverb delay time in milliseconds or note-based with Tempo Sync ON.
- Low Band Shelving Level: Post reverb shelving boost/cut of low frequencies with cutoff at 350 Hz.

- High Band Shelving Level: Post reverb shelving boost/cut of high frequencies with cutoff at 2000 Hz.
- Echo Feedback: Feedback amount around the post reverb echo.
- Modulation Rate: The modulation rate from 0 to 100.
- Modulation Type and Depth: Select modulation type and depth:
 - Swept Verb
 - Flanger Mix
 - Chorus Mix
- Echo Tone: Tone control in the feedback loop of the echoes.

Factory Presets

- Ambience
- Ekospace-God
- Flange Tiles
- JungleAppetite
- Matrix Decay
- ModEchoVerb
- Planetarium1
- SolarDelay

Plate

Plate simulates the sound of early analog-mechanical reverbs. This Algorithm allows for long reverb times that won't take over your sound. Be sure to play with the Low Damp and High Damp knobs to explore the full palette of tonal variations.

- Mix: Determines the relative level of the wet and dry signals.
- Decay: Decay in seconds or note-based with Tempo Sync ON.
- Size: Plate size.
- Pre Delay: Pre delay in milliseconds or note-based with Tempo Sync ON.
- Low Damp: Sets the damping frequency for the low end.
- High Damp: Sets the damping frequency for the high end.
- Distance: Sets room/transducer distance from source/plate driver.
- Diffusion: Adjusts diffusion amount which affects reverb build up and tail density.
- Mod Level: Mixes in random modulation in reverb tail.
- Tone: A pre-reverberator tone control, -100 to 0 is darker, 0 to 100 is brighter.

Factory Presets

- Centauri
- Dinner Plate
- GuitPlate
- Just Cuz
- OilDrum
- Plate
- Pressure
- Sift Plate
- Space Plate

Reverse Reverb

A true reverse reverb followed by a forward reverb with delay and feedback. Turn Size and Feedback all the way down for a straightforward tempo-sync-able rush-up reverse reverb, use Size to dial in a second reverb for increased wetness, and add Feedback around the whole thing for other-worldly ambiance. Infinite and Freeze are available on the Size knob and affects the forward reverb only.

- Mix: Wet/dry mixer, 100% is all wet signal.
- Decay: Reverse decay in milliseconds or note-based with Tempo Sync ON (also the delay amount for Late Dry Signal Level).
- Size: Mixes in a standard reverb that is post reverse section for bigger sounds.
- Feedback: Amount of delay feedback around reverse reverb (delay amount is Decay amount).
- Low Level: Shelving boost/cut of low frequencies.
- High Level: Shelving boost/cut of high frequencies.
- Late Dry Signal Level: Adjusts amount of dry signal that occurs directly after the reverse build up.
- Diffusion: Diffusion in the reverse build-up: set to zero for a mechanical stutter.
- Modulation Level: MicroPitch detuning modulation at the input.
- Contour: Increase the span between low and high crossover frequencies for the Low Level and High Level. Affects the sound unless Low Level and High Level are both set to 0.

Factory Presets

- Alien Verb
- Continuum
- Garble Space
- Ghost Plate
- Reflexive
- Reverse
- SpinDizzy
- Tweet Off

Room

Room is designed to dial in realistic room sounds from vocal booths to small halls. The controls allow for precision tweaking of early reflections, late reverb, and EQ. Room is the workhorse Algorithm for placing a sound in a realistic space or adding that subtle fattening that isn't immediately noticed but is always immediately missed.

- **Mix:** Determines the relative level of the wet and dry signals.
- **Decay:** Decay in seconds or note-based with Tempo Sync ON.
- **Size:** Room size.
- **Pre Delay:** Pre-delay in milliseconds or note-based with Tempo Sync ON.
- **Low Band Shelving:** Post reverb shelving boost/cut of low frequencies with cutoff at 350 Hz.
- **High Band Shelving:** Post reverb shelving boost/cut of high frequencies with cutoff determined by High Band Cutoff Frequency parameter.
- **Early/Late Reflection Levels:** Control the levels of the early and late reflections.
- **Diffusion:** Adjusts diffusion amount which affects reverb build up and tail density.
- **Modulation Level:** Adds random modulation of both diffusors and late reverb tail.
- **High Band Cutoff Frequency:** Control the corner frequency of High Band Shelving. No affect if High Band Shelving parameter is set to 0.

Factory Presets

- Boxy Room
- PCM60Room
- CanisMajor
- Room
- Guitar Room
- Room 667
- Lux Space
- Shutter Room

SP2016 Reverb

An emulation of the reverb processing from Eventide's classic [SP2016 Signal Processor](#).

- **Mix:** Controls the mix between the unprocessed input and the reverberated output. This is especially useful when some pre-delay is added.
- **Reverb Type:** Selects the reverb Algorithm. SP2016 Reverb features three reverb Algorithms, Stereo Room, Room, and Plate. Each Algorithm is available in two versions: Vintage and Modern.

The Vintage Algorithms are modeled on the original SP2016's Algorithms and hardware, and feature a lower bit-depth than the modern versions. The Modern Algorithms are brighter, more diffuse, and use a higher bit-depth.

Note

The Position, Diffusion, and EQ controls are disabled for the Vintage Plate Algorithm because they were not present in the original SP2016 Algorithm.

- Decay: Sets the reverb time.
- Position: This is used to move your “listening position” from the front of the “room” to the rear. You’ll find that Position is one of the most useful controls in adjusting the reverb to fit your mix. A simplified explanation: it changes the mix between the early and late reflections; what actually happens in the Algorithm is more complex than this, however.
- Diffusion: This alters the character of your space – from the sharp reflections of flat, hard surfaces (low) to the diffused reflections from rough, irregular ones (high). The Diffusion control doesn’t change the decay time, but it does have an effect on the evident nature of the decay by thickening or thinning its density. Note that this can often be a subtle difference and may be difficult to hear with some types of program material and/or with long decay times. The effects of the control will be most apparent with short decays and program material with percussive attacks.
- Pre Delay: Introduces a delay before the reverb effect. SP2016 Reverb is capable of long pre-delays, up to 999 milliseconds, and these can be used to create echo effects as well.

Note

The equalization section provides controls for high and low shelving filters. These controls affect parameters deep within the feedback structure of the reverberator and the effect may be subtle or dramatic depending on the program material and other reverb settings such as Decay, Position, or Diffusion. In general, the controls will have more pronounced effects at longer decay times and more distant position settings. Additionally, it's usually easier to hear the effect of changes to the high frequency controls than it is to hear changes to the low frequency controls.

- Low Freq: Sets the corner frequency for the low shelving filter; the range is from 50 to 500 Hz in increments of 50 Hz.
- Low Gain: Adjustable gain for the low shelving filter, from -8 to +4 dB.
- High Freq: Sets the corner frequency for the high shelf filter; the range is from 1000 to 8000 Hz in increments of 500 Hz.
- High Gain: Adjustable gain for the high shelf filter, from -8 to 0 dB.

Factory Presets

- Bedroom
- Desert Plate
- Echo Room
- Empty Auditorium
- SP2016 Reverb
- Vintage Plate
- Vintage Room
- Vintage Stereo

Spring

Spring models the sound and character of the popular artificial reverbs found in guitar amplifiers. It also goes a step further by allowing access to physical parameter controls not readily available in a real spring tank. By tweaking these parameters, the Spring Algorithm can create faithful representations of real springs or push the physical boundaries to achieve new distinctive sounds. Pay extra attention to the

Tension and Num Spring knobs to control the amount of 'springiness'. For good measure, we've also included a tube amp style tremolo.

- Mix: Wet/dry between reverb and tremolo dry signal.
 - If Tremolo Pre/Post is set to Pre, then this controls the wet/dry mix between the spring reverb and the tremolo'd dry signal.
 - If Tremolo Pre/Post is set to Post, then this controls the wet/dry mix between the tremolo'd spring reverb and the unaltered dry signal.
- Decay: Decay in seconds or note-based with Tempo Sync on.
- Tension: Controls spring tension.
- Number of Springs: Number of springs in the 'tank,' mixes in 1 to 3 springs.
- Low Band Damping: Sets the damping frequency for the low end.
- High Band Damping: Sets the damping frequency for the high end.
- Tremolo Intensity: The depth of the tremolo.
- Tremolo Rate: The speed of the tremolo in Hz or note-based with Tempo Sync ON.
- Tremolo Pre/Post: Places the tremolo before or after the spring reverb. Note that when in Pre mode, the Mix control only affects the reverb signal. Tremolo will still be applied to the dry signal.
- Modulation Level: Mixes in modulation for a nice chorusing effect.
- Resonance: Metallic resonance at the High Band Damping frequency.
- Spring Type: Select from 2 different reverb tank size. Large and small.

Factory Presets

- AmeSpring
- Big` Balls
- Dark Spring
- Deluxe
- Gutter Flange
- RW Tank
- Spicy Spring
- Spring
- Spring Time
- SpringTheory

Shimmer

We don't have proof, but we're pretty sure this is what the guitars sound like in heaven. Set Pitch Shift A and B to just above and below 1200c, turn the Delay all the way down, and everything else all the way up. Oh, and remember to walk toward the light.

- Mix: Wet/dry mixer, 100% is all wet signal.

- Decay: Arbitrary 0-100 decay (less decay will also take away reverb attack).
- Size: Size of the reverb.
- Delay: Post reverb and pre pitch-shift delay time in milliseconds or note-based with Tempo Sync on.
- Low Band Decay: Amount of post reverb and pitch-shifter low band signal (this is in the feedback path).
- High Band Decay: Amount of post reverb and pitch-shifter high band signal (this is in the feedback path).
- Pitch Shift A: Pitch-shifter A's pitch in cents
 - 500c = P4th
 - 700c = P5th
 - 1200c = 1 Octave
 - 1900c = 1 Octave+P5
 - 2400 = 2 Octaves
- Pitch Shift B: See description for Pitch Shift A
- Pitch Decay: The Pitch Decay knob controls the amount of pitch shifting in the reverb tail. It increases from 0 to 100. Beyond 100 are two Freeze modes. Pitch Freeze locks out the pitch shifters, but feeds the reverb, allowing you to freeze the Shimmer pitch climb at opportune times. Pitch+verb Freeze freezes everything (pitch and reverb) for dry soloing on top of the frozen reverb.
- Mid Band Decay: Amount of post reverb and pitch-shifter mid band signal (this is in the feedback path).

Factory Presets

- Amedeo-Bass-Shim
- Dark Angels
- Demon Call
- Gunshot Snare
- Hells Gate
- Ironworx
- Mountains
- Neros Ascent
- Quasar
- Shimmer
- Size Matters
- Sneaky Verb
- Touched By An H9

TremoloVerb

TremoloVerb is a celestially large reverb cut back down to Earth size by an aggressive tremolo. Use the Sine, Triangle, Peak, Ramp, or Square waves to create a rhythmic ambience; Random and Sample/Hold too

create a convulsing cloud; Envelope or ADSR to control the reverb with your playing; or the Expression Pedal to control it with your foot.

- Mix: Wet/dry mixer, 100% is all wet signal.
- Decay: Decay in seconds or note-based with Tempo Sync ON.
- Size: Room size of reverb.
- Pre Delay: Pre-delay time in milliseconds or note-based with Tempo Sync ON.
- Low Band Shelving Level: Post reverb shelving boost/cut of low frequencies with cutoff at 350 Hz.
- High Band Shelving Level: Post reverb shelving boost/cut of high frequencies with cutoff at High Freq.
- Tremolo Shape: Selects the waveform, or source, of the modulation. The choices are:
 - Sine
 - Triangle
 - Peak
 - Random
 - Square
 - Ramp
 - SampHold
 - Envelope: The modulation becomes driven by the amplitude of the audio input.
 - ADSR: The modulation becomes driven by an ADSR triggered by the amplitude of the audio input.
 - Manual: When selected, the Manual Mod parameter will control the modulation.
- Tremolo Speed: Tremolo speed in Hz, sensitivity, or note-based with Tempo Sync on.
- Tremolo Depth/Mono or Stereo: Tremolo depth, in stereo mode you have the option to have mono depth (same on both channels) or stereo depth (tremolo is 90 degrees out of phase).
- High Band Cutoff Frequency: The high corner frequency of High-level. Affects the sound unless High-level is set to 0.

Performance Parameters

- Retrigger: Retrigger the LFO to the beginning of the cycle. Useful for re-syncing during playback, or creative effects.

Factory Presets

- ABitShakey
- Horror Show
- AmeTremVerb1
- Splitter Verb
- AmeTremVerb2
- TremoloVerb
- Broken Glitch

Wormhole

Mega-sized, tilting reverb. How deep are you willing to go?

- Mix: Wet/dry mixer, 0 is fully dry, 100 is fully wet.
- Length: Wormhole distance in light years. Controls the decay time of the reverb. Internally tapered from 0 l.y. (shortest decay, 3s) to 100 l.y. (longest decay, 1000s). (0 to 100 l.y. or 30.67 parsecs).
- Diameter: Width of the interstellar Wormhole. Controls the size of the reverb. A Diameter of 0 is tight enough to pull the ears off a gundark. A Diameter of 100 will fit Executor-class Super Star Destroyers eight abreast.
- Lo Decay: Decay rate of the low frequency content of the reverb. 0 is quickest decay. 100 is slowest decay.
- Hi Decay: Decay rate out of the high frequency content of the reverb. 0 is quickest decay. 100 is slowest decay.
- Entry Field: Entrance characteristics to the Wormhole. Controls early reflections and diffusion in the reverb. 0 is a rougher entrance to the WormHole (less diffuse, noticeable early reflections). 100 is a smoother entrance to the Wormhole (more diffuse, less noticeable early reflections).
- Pre Delay: Delay added before Wormhole entrance. (0 to 2000ms)
- Stability: Wormhole stability across time. Controls modulation depth of the reverb. 0% is the least stable Wormhole with large pitch variations happening to the reverb through time (max modulation/most unstable). 100% is a stable Wormhole with no reverb pitch variations through time (no modulation).
- Stability Rate: Movement speed of an unstable Wormhole. Controls modulation rate of the reverb. Range is from 0 (slowest rate) to 100 (fastest modulation rate). Use in conjunction with the Stability control.
- Warp Acceleration: How long it takes to traverse the wormhole and reach the top warp speed set by the Warp Factor control. Units are in total time to traverse the worm hole and lower values accelerate faster. Controls the rate of change of the reverb delay lines. (1.0 to 10s)
- Warp Factor: Top warp speed desired through the worm hole. Higher Factors manifest as a higher final pitch changes. Warp Factor 10.00 theoretically highest possible speed. Controls the amount of change of the delay lines. (5 to 10s)

- Warp Mix: Sets the mix level of the effect during warping, overrides the Mix control.
- Warp Bass: Bass EQ control for Warp effect.
- Warp Treble: Treble EQ control for Warp effect.

Performance Parameters

- Warp (L): Latching footswitch. Press once to go thru the entire warping cycle. Footswitch unlatches after cycle completion.
- Warp (M): Momentary footswitch. Hold to keep warp cycle engaged. Releasing before cycle completion generates a “deceleration” (decreasing pitch) sound to the warp effect.

Factory Presets

- Deep Spaced
- Drowned Lands
- Kessel Run
- New Junk City
- Snake Portal
- Spaceplate
- Spaceplate 2
- Worm Delay
- Wormhole
- Wormhole Serpent

Synth

HotSawz

Just like a synth, HotSawz is a musical palette for creating interesting sounds. HotSawz is based around classic subtractive synthesis using saw waves for all oscillators. We're using 6 oscillators that follow a mono pitch tracker. The filter type is low pass.

HotSawz has three modulation sources: LFO, Envelope Follower, and a Gate, as well as four assignable modulation destinations: Filter Cutoff, Volume, Pitch, and Oscillator Depth. Each source can be assigned to any destination at a given time, so multiple sources can modulate the same destination. There are 64 combinations of source to destination assignments.

- **Mix:** Knob has four ranges, each 0 to 100. Each range mixes the dry signal with various oscillator combinations.
 - **Sub Mix:** Mixes in lower octave oscillators only.
 - **S + R Mix:** Mixes in lower octave and current register oscillators together.
 - **All Mix:** Mixes in lower octave, current register, and octave above oscillators together.
 - **R + U Mix:** Removes sub octave oscillators. Mixes in current register and upper oscillators together.
- **Osc Depth:** Mixes in 2nd oscillators for each register and adds detuning. Also spreads the oscillators across the stereo field. Modulation sources assigned to Osc Depth are additive.
- **Cutoff:** Controls the cutoff frequency of the low pass filter. Filter is in series with wet signal. Modulation sources assigned to Cutoff are additive.
- **Resonance:** Controls the low pass filter's resonance.
- **Speed:** Controls LFO's wave shape and speed. This parameter has four ranges, each 0.1 Hz to 20 Hz or Whole note to 1/16 note divisions. Each range switches the LFO wave shape.
 - **Tri Spd:** Triangle.
 - **Square Spd:** Square.
 - **Ramp Dn Spd:** Decaying Ramp.
 - **Ramp Up Spd:** Rising Ramp.
- **LFO Amount:** Assigns LFO destination and controls amount of modulation. Knob has four ranges. Each range assigns the LFO to a different destination for modulation.
 - **Cutoff:** Assigns LFO to modulate Cutoff frequency.
 - **Volume:** Assigns LFO to modulate wet output level.
 - **Pitch:** Assigns LFO to modulate pitch +/- 3600 cents.

- Depth: Assigns LFO to modulate Oscillator Depth.
- Attack: Gate Attack speed from 0 to 3000ms. When the Gate Sustain/Range knob is set to OFF, Attack knob has no effect.
- Decay: Gate Decay speed from 0 to 3000ms. When the Gate Sustain/Range knob is set to OFF, Decay knob has no effect.
- Gate: Assigns gate destination and controls amount of either Sustain or Range of the Gate. Knob has four ranges. Gate Sustain level occurs after both Attack and Decay of the Gate (There is no release in the Gate). Gate Range (for Pitch as destination) is how far from 0 pitch modulation is allowed to go at the end of Gate attack.
 - Off: Disconnects the Gate. Attack and Decay control will have no affect on signal.
 - Cutoff: Assigns the Gate to modulate Cutoff frequency.
 - Volume: Assigns Gate to modulate wet output level.
 - Pitch: Assigns Gate to modulate pitch Range +/-3600 cents. Returns to 0 modulation after Gate Decay.
 - Depth: Assigns Gate to modulate Oscillator Depth.
- Envelope: This Envelope is triggered and drawn by dynamics of input level. This parameter assigns Envelope destination and controls amount of modulation. It has four ranges, each 0 to 100. Each range assigns the Envelope to a different destination for modulation.
 - Cutoff: Assigns the Envelope to modulate cutoff frequency.
 - Volume: Assigns the Envelope to modulate wet output level.
 - Pitch: Assigns the Envelope to modulate pitch.
 - Depth: Assigns Envelope to modulate Oscillator Depth.

Performance Parameters

- Retrigger: Retriggers the LFO to the beginning of the cycle. Useful for re-syncing during playback, or creative effects.

Factory Presets

- Analog-ish Lead
- Camino
- Choo Choo
- Dark Castle Bass
- Drop Out of Warp
- Faux Horns
- Funky Sauce
- Hot Bass
- Knife Walker
- Knife Walker 2
- Laser Gun
- Major HotSwitch
- Melting Tones
- Mtumeday
- Pass Out Bass
- Peppery Rezo Bass
- Picante Pluck
- Pitchup Synth
- Poblano Peril
- Pulsar
- Sahuaro Staccato
- Serrano Sub
- Seventies Spicy Lead
- Siren
- Sonic Boom
- Space Chihuahua
- Synth Filter Bass
- Synth Surfing
- Synth Wah Bass
- Tabasco
- Top Gumdrop
- Venus Attacks
- Wasabi Lead

PolySynth

Did anyone order extra Sawz? Using our new SIFT technology found in the Polyphony, Prism Shift, and PolyFlex algorithms, and building on the earlier work done for our HotSawz algorithm we've created PolySynth - a fully polyphonic Guitar to Synth transformer. With up to 3 voices, multiple modulation options, and envelope control of the filter cutoff you can add just a drop of synth tone, or layer it on extra thick.

- Mix: Controls the amount of dry and pitch shifted signal. 0 to 100.
- Attack: Controls the Attack time of the generated synth sounds. 5 to 1000 ms or Tempo Based.
- Resonance: Controls the resonance of the filters after each synth voice. 0 is no resonance, 100 is very resonant. 0 to 100.
- Cutoff: Controls the cutoff frequency of the filter. 0 to 100.
- Env Amount: Sets the maximum amount the filter cutoff will open or close to (start is always what is set by the Cutoff knob). -100 to 100.
- Env Sense: Adjusts the sensitivity of the envelope or how hard do you need to play to get it to hit the value set by Env Amount. 0 to 100.
- LFO Destination: Sets what parameter the LFO is modulating:
 - Cutoff
 - Volume
 - Pitch

- PWM
 - Detune
- LFO Amount: Controls the amount of modulation the LFO applies. -100 to 100.
 - LFO Rate: Sets the speed of the LFO. 0.01 to 20.0 Hz or Tempo Based.
 - LFO Shape: Sets the shape of the LFO:
 - Sine
 - Triangle
 - Square
 - Peak
 - Ramp Up
 - Ramp Down
 - Random
 - Sample & Hold
 - Detune: Controls the detuning of all three voices. Adds a variable amount to each such that modulation is still heard even with two voices. -100 to 100.
 - Spread: Pans Voice 1 and Voice 3 to opposite sides while keeping Voice 2 in the middle. -100 to 100.
 - Freeze Release: Determines the release time after a sound is un-frozen. NOTE: It is intended that no new notes are played during a freeze release, but as they say - all rules are made to be broken.
 - Pitch Wheel: A parameter designed to be mapped to an external controller (MIDI, Exp Pedal, etc). Mimics a pitch wheel on an actual keyboard and modulates the pitch +/- 1200c.
 - Playstyle: Tunes the algorithm to either monophonic or polyphonic playing (or somewhere in between). Monophonic will result in the purest synth tones, Polyphonic will result in better tracking.

Tip

In addition to adjusting the Playstyle parameter, tracking is generally improved when using the neck pickup.

The following parameters apply to each voice:

- Level: Level of each oscillator. 0 to 100.
- Shift: The shift amount of the oscillator voice given in musical intervals. -Oct, -M7, -m7, -M6, -m6, -P5, -Tri, -P4, -M3, -m3, -M2, -m2, Uni, m2, M2, m3, M3, P4, Tri, P5, m6, M6, m7, M7, Oct
- Shape: The waveform for the oscillators:
 - Saw
 - Square
 - Triangle
 - Narrow Pulse
 - Wide Pulse

Performance Parameters

Freeze: Performance parameter which freezes the current synth sound.

LFO Retrig: Momentary performance parameter which retriggers the LFO.

Synthonizer

Synthonizer tracks the pitch of the note that you're playing and generates a synthesized tone at the same pitch. Voice A is an additive synthesizer useful for creating organ or Theremin-style sounds; Voice B is a subtractive synthesizer for creating classic analog-style synth sounds.

- Mix: Wet/dry mixer, 100% is all wet signal.
- Vox Mix: Controls the ratio of the two synthesized voices A and B.
- Wave Mix A: Controls the mix of the various added waveforms to control the tone and perceived pitch of voice A.
- Octave B: Controls the blend between unison, 1 octave down, and 1 octave up synth voices to control the tone and perceived pitch of voice B.
- Attack A: Controls the attack time for synthesized voice A.
- Attack B: Controls the attack time for the filter on synthesized voice B.
- Verb Level: Sets the reverb level.
- Verb Decay: Sets the reverb decay time.
- Shape A: Selects voice A waveshape:
 - Sine

- Triangle
- Sawtooth
- Organ 1
- Organ 2
- Sweep B: Controls the sweepable filter on voice B. Values from 0 to 50 sweep a low-pass filter, values from 50 to 100 sweep a high-pass filter.

Performance Parameters

Flex: Shifts both voices up one octave.

Factory Presets

- Basic Synth
- FluteFactor
- Motorbike Lead
- TromboneFactor
- Welcome To The Machine

Utility

Mute

Mutes incoming audio completely.

Thru

Passes audio through unaffected.

This page was intentionally left 99.88% blank.

A. TECH SUPPORT

H90 Videos

This playlist includes helpful tutorials for setting up and using your H90: <https://etide.io/H90-videos>

Eventide Stompbox Forum

The official Eventide forum for the H90 and other stompboxes: <https://etide.io/forums-pedals>

H90 Official Facebook Group

A group where H90 users can interface with each other and members of the Eventide team: <https://etide.io/H90-FBUG>

H90 FAQ

Get answers to frequently asked questions and get the most out of your H90: <https://etide.io/H90-FAQs>

Contact Eventide Support

If you need technical assistance or product repair, you can email support@eventide.com to submit a ticket to our support department. Please include a detailed report of your problem including your H90's serial number, firmware version, and what version of H90 Control you are using. Most inquiries are answered within 24-48 business hours. Note, we are closed on weekends.

This page was intentionally left 99.88% blank.

B. TECH SPECS

Latency Specifications

Preset Routing Mode	Total Latency
Parallel	3.8 ms
Series	4.5 ms

Note

- Program and Preset level parameters such as mix, bypass, kill dry, and bypass mode do not contribute to the total latency.
- Each insert adds 3.8ms of latency, plus any additional latency compensation specified in the Insert setting.

Power specifications

Center Positive (+), 5.5/2.5 mm jack

Voltage	Amperage
12 VDC	600 mA
9 VDC	800 mA

Digital Specifications

Sample Rate	Bit Depth
48 kHz	AD/DA 24-bit, DSP 32-bit floating point

Audio Specifications

Audio Specifications

Input Impedance

Instrument Level > 600 kOhm

Line Level 80 kOhm

Recommended Load 10 kOhm

Output Impedance

Instrument/Line Level 220 Ohm

Maximum Input Level

Instrument Level +4 dBu

Line Level +14 dBu

Analog Audio Connections

Number of Channels Four inputs, Four outputs, ¼" MONO TS jack

Operating Levels User configurable: Instrument or Line level

Control Connections

EXP/CTL Inputs

Two ¼" TRS inputs. Up to two 10-25 K expression pedals, 0-5 V control voltage sources, 3-button aux switches, or combination

MIDI Connections

5-pin DIN Input, 5-pin DIN Output/Thru

USB-C

Physical Dimensions	
Size	Net Weight
2.5 H x 6.5 W x 5.25 D in	1.85 lbs
65 H x 179 W x 136 D mm	1.36 kg

All specifications are subject to change or improvement at any time without notice or obligation. Please visit <https://etide.io/H90Specs> for updated product specifications.

This page was intentionally left 99.88% blank.

C. GLOBAL MAPPING CHART

Global MIDI and Pedal Control allows you to define external controllers such as MIDI controllers, aux switches, and expression pedals that will always affect the H90's parameters, regardless of what Program is loaded. For example, if you'd like an expression pedal to always control HotKnob P, you can configure this using the Global Pedal Control.

- The H90 has no default MIDI CC or external controller mappings, all mappings are customizable by the user.
- Global Pedal Mappings and Global MIDI Mappings offer the same parameter mapping options. See chart below.

Tip

An Active/Bypass mapping such as "P Act/Byp" will toggle between the active and bypassed state of the Program, this will be triggered by a MIDI CC value of 64 or greater.

When using "P Act/Byp (M)", the bypassed state will be triggered with a CC value less than 64, the active state will be triggered with a CC value of 64 or greater.

Using "P Act/Byp (M)" can allow you to send a separate Bypass and Active MIDI message by simply programming one switch to send a CC value less than 64, and another switch to send a CC value of 64 or greater.

Global Mapping Options	
Parameter	Description
Load	Load the currently cued up Program, plus Act/Byp toggle of a loaded Program
Increment	Increment and cue up a new Program
Decrement	Decrement and cue up a new Program
Inc + Load	Increment Program and load immediately

Global Mapping Options	
Dec + Load	Decrement Program and load immediately
Bank Up	Increment three Programs to next Bank
Bank Down	Decrement three Programs to the previous Bank
Tuner	Enter / Exit Tuner Mode
Tap Tempo	Program Tap Tempo
Mode Toggle	Toggles b/t SELECT and PERFORM Mode
SELECT Mode	Enter SELECT Mode
PERFORM Mode	Enter PERFORM Mode Mode and increment through PERFORM pages
BANK Mode	Enter BANK Mode
P Act/Byp	Program Active / Bypass toggle
P Act/Byp (M)	Momentary Program Active
A Act/Byp	Preset A Active / Bypass toggle
A Act/Byp (M)	Momentary Preset A Active
B Act/Byp	Preset B Active / Bypass toggle
B Act/Byp (M)	Momentary Preset B Active
Ins 1 Act/Byp	Insert 1 Active / Bypass toggle
Ins 2 Act/Byp	Insert 2 Active / Bypass toggle
HS1	Engage HotSwitch 1
HS1 (M)	Momentary engage HotSwitch 1
HS2	Engage HotSwitch 2
HS2 (M)	Momentary engage HotSwitch 2

Global Mapping Options	
HS3	Engage HotSwitch 3
HS3 (M)	Momentary engage HotSwitch 3
PERFORM 1	Engage Program Performance Parameter 1
PERFORM 2	Engage Program Performance Parameter 2
PERFORM 3	Engage Program Performance Parameter 3
PERFORM 4	Engage Program Performance Parameter 4
PERFORM 5	Engage Program Performance Parameter 5
PERFORM 6	Engage Program Performance Parameter 6
Quick Knob 1	Adjust Program Quick Knob 1
Quick Knob 2	Adjust Program Quick Knob 2
Quick Knob 3	Adjust Program Quick Knob 3
Quick Knob 4	Adjust Program Quick Knob 4
Quick Knob 5	Adjust Program Quick Knob 5
Quick Knob 6	Adjust Program Quick Knob 6
P HotKnob	Adjust Program HotKnob
A HotKnob	Adjust Preset A HotKnob
B HotKnob	Adjust Preset B HotKnob
P In Gain	Adjust Program Input Gain
P Out Gain	Adjust Program Output Gain
A In Gain	Adjust Preset A Input Gain
A Out Gain	Adjust Preset A Output Gain
B In Gain	Adjust Preset B Input Gain

Global Mapping Options

B Out Gain

Adjust Preset B Output Gain

P Mix

Adjust Program Mix

D. STARTUP SEQUENCES

By pressing and holding certain button combinations while inserting the power cable, you can perform the following functions:

D.1. Recovery Mode

- Connect the provided USB-C cable from your H90 to your computer.
- Press and hold the Select Knob, Perform Knob, and Quick Knob 1, while inserting the power cable to enter Recovery Mode. The screen will display “Recovery Mode”.



Fig. D.1 The H90 is in Recovery Mode.

- Open H90 Control, click the burger icon in the top left corner, and select “H90 Recovery”.
- Select a release from the list of software releases and click “Install”.

D.2. Clear Current State

Press and hold Quick Knob 1 while inserting the power cable until the text “Clearing current state” appears on the H90’s screen. This will not erase any saved Lists, Programs, or Presets, but it will clear the currently loaded Program and reset the System and Tempo settings.



Fig. D.2 The H90's state is being cleared.

D.3. Factory Reset

Press and hold all three Quick Knobs while inserting the power cable until the text "Performing factory reset" appears on the H90's screen.



Fig. D.3 The H90 is being factory reset.

Warning

A Factory Reset will erase all User Lists, Programs, and Presets. This will also reset the System and Tempo settings. This will not downgrade the H90's software.

E. LEGALESE

5.1. Safety and Warranty

Safety Information

- No operator access to the internals of the unit is permitted; servicing must be performed by qualified personnel only.
- The unit must **not** be operated with a damaged or ungrounded power cord.
- Use only with supplied power supply.
- Avoid spilling liquids onto/into the unit.
- Do not expose to excessive heat or moisture.

Limited Warranty

Eventide Stompboxes are built to exacting quality standards and should give years of trouble-free service. If you are experiencing problems which are not cleared up in this manual, your recourse is this warranty.

What the Warranty Does and Does Not Cover

Eventide Inc. warrants the above-identified unit to be free from defects in workmanship and material under normal operation and service for a period of one year from the date of purchase, as detailed below.

At our discretion within the warranty period, we may elect to repair or replace the defective unit. This means that if the unit fails under normal operation because of such defect, we will repair the defective unit at no charge for parts or labor. We also assume a limited responsibility for shipping charges, as detailed below.

The warranty does not extend beyond repair or replacement as stated herein and in no event will we be responsible for consequential or incidental damages caused by any defect, and such damages are specifically excluded from this warranty. Our sole obligation is to repair or replace the defective unit as described herein.

The warranty **DOES NOT COVER** any damage to the unit regardless of the cause of that damage. The unit is a complex piece of equipment that does not react well to being dropped, bounced, crushed, soaked or exposed to excessively high temperatures, voltages, electrostatic or electromagnetic fields. If the unit is damaged for these or similar causes, and the unit is deemed to be economically repairable, we will repair it and charge our normal rates.

The warranty **DOES NOT COVER** shipping damage, either to or from Eventide. If you receive a new unit from us in damaged condition, notify the carrier and us; we will arrange to file an insurance claim and either repair or exchange the unit.

If you receive a new unit from a dealer in damaged condition, notify the dealer and the carrier.

If we receive the unit from you with apparent shipping damage, we will notify you and the carrier. In this case, you must arrange to collect on any insurance held by you or your carrier. We will await your instructions as to how to proceed with the unit, but we will charge you for all repairs on damaged units.

Who is Covered Under the Warranty

The warranty applies to the original purchaser of a new unit from Eventide or an Authorized Eventide Dealer. Demo units are also covered by this warranty under slightly different circumstances (see below).

Units that are used, or have been used as part of a rental program, are not covered under any circumstances.

It is your responsibility to prove or to be able to prove that you have purchased the unit under circumstances which activate the warranty. A copy of your purchase invoice is normally necessary and sufficient for this.

If you have any questions about who is an Authorized Eventide Dealer, call us. Units with the serial number plate defaced or removed will not be serviced or covered by this warranty.

When the Warranty Becomes Effective

The one-year warranty period begins on the day the unit is purchased from an Authorized Eventide Dealer or, if the unit is drop-shipped from Eventide, on the day shipped, plus a reasonable allowance for shipping delays. This applies whether or not you return your warranty registration form.

Warranty Information

When we receive a unit, this is how we determine whether it is under warranty:

1. If the unit was shipped from our factory within the past calendar year, we assume that it is under warranty unless there is evidence to the contrary, such as its having been sold as used or rented, etc.

2. If the unit was shipped from our factory more than a calendar year ago, we assume it is not under warranty unless:
 - There is a warranty registration form on file showing that it has been purchased within the past year under appropriate conditions.
 - You send a copy of your purchase invoice indicating warranty status along with the unit.

3. If the unit was used as a demo, the warranty runs from the date that it was received by the dealer. The original purchaser gets the unexpired portion of that warranty.

When you send a unit for repair, you should indicate whether or not you believe it to be under warranty. If you do not say the unit is under warranty, we will charge you for the repair and we will not refund unless the charge was caused by an error on our part. If you believe the unit to be under warranty and you do say it is but we disagree, you will not incur any charges until the dispute is resolved.

Reading the above, you can see that it is to your advantage to send in the warranty registration form when you purchase the unit. If we know who you are, we can send you updates and notifications, and advise you of our new products. It will also enable you to receive pre-shipment of certain parts.

Who Performs Warranty Work

The only company authorized to perform work under this warranty is Eventide Inc., Little Ferry, New Jersey. While you are free to give personal authorization to anyone else (or to work on it yourself), we will not honor claims for payment for parts or labor from you or from third parties.

However, we and our dealers do try to be helpful in various ways. Our dealers will assist, usually without charge during the warranty period, in:

- Determining whether there is a problem requiring return to the factory.
- Alleviating user error or interconnection problems that may be preventing the unit from operating to its full capability.

We are available for email and telephone consultation if the dealer is unable to assist.

If a part is found to be defective during the warranty period and you wish to replace it yourself, we will normally ship the part immediately at no charge, provided your warranty registration form is on file. We reserve the right to request that the defective part be returned to us.

Shipping Within the 50 United States

You are responsible for getting the unit to our door at no cost to us. We cannot accept collect or COD shipments.

We will return the unit to you prepaid, at our expense, using an expeditious shipping method, normally United Parcel Service. In areas not served by UPS we will ship by US Mail.

If you are in a hurry and want us to use a premium shipping method (such as air express, next day air, etc.), be sure you tell us and agree to pay shipping charges collect. If you specify a method that does not permit collect or COD charges, remit sufficient funds to prepay shipping.

Shipping Outside the 50 United States

If you purchased the unit from a dealer in your country, consult with the dealer before returning the unit.

If you wish to return the unit to us, please note the following:

1. The unit must be prepaid to our door. This means that you are responsible for all shipping charges, including customs brokerage and duties. When a unit is shipped to us it must be cleared through United States Customs by an authorized broker. You must make arrangements for this to be done. Normally, your freight forwarder has a branch in the United States, which can handle this transaction. If you want our assistance, you must notify us before shipping the unit for repair, giving full details of the shipment, and including a minimum of \$250.00 in US funds to cover the administrative and brokerage expenses. Any balance will be applied to the repair charges or refunded. If a balance is due to us, we will request a further prepayment.
2. All shipments will be returned to you collect. If this is impossible because of shipping regulations or money is due us, we will request prepayment from you for the appropriate amount.
3. All funds must be in US dollars. Payment may be made by check drawn on any bank in the US, or by telegraphic funds transfer to our bank. If you send US currency, be sure that it is sent by a method you can trace, such as registered mail. If you wish to pay by Letter of Credit, be sure that it affords sufficient time for work to be performed and the L/C negotiated, and that it is free from restrictive conditions and documentation requirements.
4. We reserve the right to substitute freight carriers. Although we will attempt to honor your request for a specific carrier, it is frequently necessary to select a substitute because of difficulties in communication or scheduling.

This warranty gives you specific legal rights and you may also have other rights, which vary from location to location.

5.2. FCC Compliance Statement



This device complies with Part 15 of the FCC Rules. Operation is subject to the following two conditions: (1) This device may not cause harmful interference, and (2) this device must accept any interference received, including interference that may cause undesired operation.

This equipment has been tested and found to comply with the limits for a Class B digital device, pursuant to Part 15 of the FCC Rules. These limits are designed to provide reasonable protection against harmful interference in a residential installation. This equipment generates, uses, and can radiate radio frequency energy and, if not installed and used in accordance with the instructions, may cause harmful interference to radio communications. However, there is no guarantee that interference will not occur in a particular installation. If this equipment does cause harmful interference to radio or television reception, which can be determined by turning the equipment off and on, the user is encouraged to try to correct the interference by one or more of the following measures:

- Reorient or relocate the receiving antenna.
- Increase the separation between the equipment and receiver.
- Connect the equipment into an outlet on a circuit different from that to which the receiver is connected.
- Consult the dealer or an experienced radio/TV technician for help.

FCC ID: QOQ13

This page was intentionally left 99.88% blank.

