

FANATEC®

CSL Pedals Clutch kit



4

Quick Guide

EN

4

Kurzanleitung

DE

1

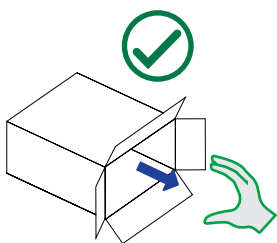
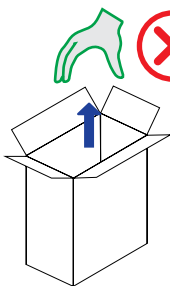
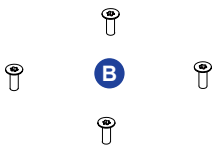
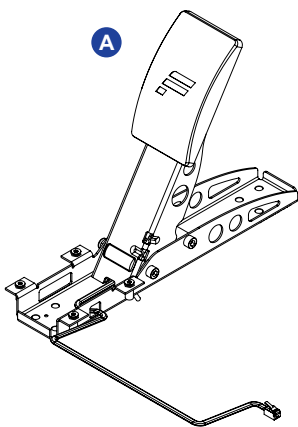

2

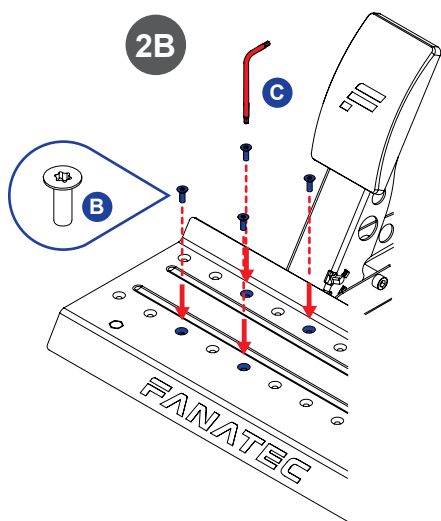
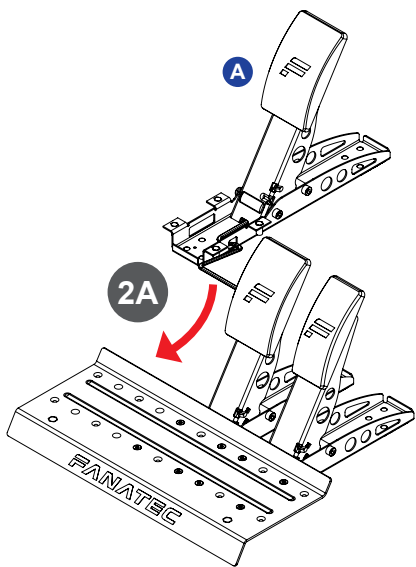

2C

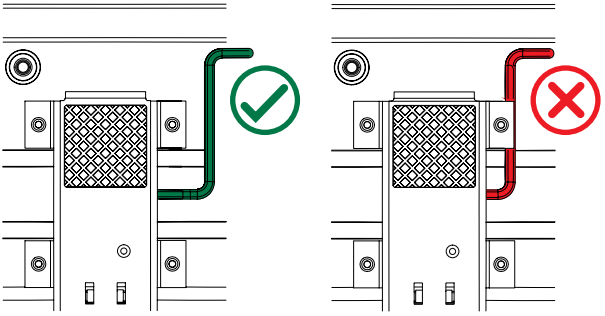

2D

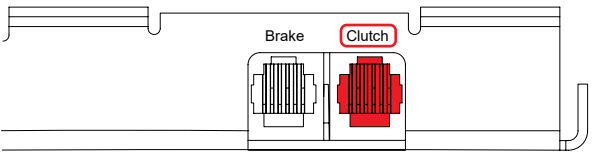

Quick Guide

1 PACKAGE CONTENTS

- A** 1x CSL Pedals Clutch Kit
- B** 4x M4x12 mm Countersunk Mounting Bolts
- C** 1x T20 Torx Key

For compatibility information, visit the product page on [Fanatec.com](https://www.fanatec.com).

2 INSTALLATION

2C **NOTE:** Clip RJ12 cable into cable buckets under heel rest.

3 SUPPORT

Our Support Team is ready to help you! Visit [fanatec.com/support/faq](https://www.fanatec.com/support/faq) for assistance.

Download our app:



[Fanatec.com/app](https://www.fanatec.com/app)

4 VIDEO

Watch our **CSL Pedals Clutch Kit** video guide:



[Fanatec.com/QR/CSL-P-CK](https://www.fanatec.com/QR/CSL-P-CK)

This product is under warranty of Endor AG. Refer to the included warranty sheets as well as the terms & conditions of Endor AG on [Fanatec.com](https://www.fanatec.com).

Kurzanleitung

1 PACKUNGSINHALT

- A** 1x CSL Pedals Clutch Kit
- B** 4x M4x12 mm Senkkopfschrauben
- C** 1x T20 Torx-Schlüssel

Informationen zur Kompatibilität finden Sie in der Beschreibung dieses Produkts auf [Fanatec.com](https://www.fanatec.com).

2 INSTALLATION

2C **HINWEIS:** Stecken Sie das RJ12-Kabel in die Kabelklappen unter der Fersenstütze.

3 UNTERSTÜTZUNG

Unser Support-Team hilft Ihnen gerne weiter! Besuchen Sie [fanatec.com/support/faq](https://www.fanatec.com/support/faq) für weitere Unterstützung.

Laden Sie unsere App herunter:



[Fanatec.com/app](https://www.fanatec.com/app)

4 VIDEO

Sehen Sie sich unser **CSL Pedals Clutch Kit** - Video Tutorial:



[Fanatec.com/QR/CSL-P-CK](https://www.fanatec.com/QR/CSL-P-CK)

Dieses Produkt unterliegt der Garantie der Endor AG. Beachten Sie die beiliegenden Garantieblätter sowie die Allgemeinen Geschäftsbedingungen der Endor AG auf [Fanatec.com](https://www.fanatec.com).



Contact | Зв'язатися:
 Endor AG
 E.ON-Allee 3 - 84036 Landshut - Germany
 Telephone | Телефон: +49 (871) 9221-122
 Email | Електронна пошта: info.webshop@fanatec.com

This product meets the requirements of the Technical Regulations which limit the use of certain hazardous substances in electrical and electronic equipment.

Цей продукт відповідає вимогам RoHS (Директива ЄС 2011/65 / ЄС).

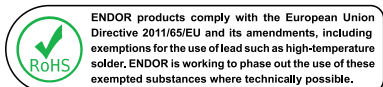

Manufactured and distributed by



Fanatec® is a registered trademark of Endor AG
 Designed and developed by Endor AG in Germany

E.ON-Allee 3 - 84036 Landshut - Germany
 Telephone: +49 (871) 9221-122 Fax: +49 (871) 9221-221
 Email: info.webshop@fanatec.com
 Website: www.fanatec.com - www.endor.ag
 Made in China

Thank you for choosing

FANATEC[®]

