

15B+/17B+/18B+ Digital Multimeters

Users Manual

LIMITED WARRANTY AND LIMITATION OF LIABILITY

Each Fluke product is warranted to be free from defects in material and workmanship under normal use and service. The warranty period is two years and begins on the date of shipment. Parts, product repairs, and services are warranted for 90 days. This warranty extends only to the original buyer or end-user customer of a Fluke authorized reseller, and does not apply to fuses, disposable batteries, or to any product which, in Fluke's opinion, has been misused, altered, neglected, contaminated, or damaged by accident or abnormal conditions of operation or handling. Fluke warrants that software will operate substantially in accordance with its functional specifications for 90 days and that it has been properly recorded on non-defective media. Fluke does not warrant that software will be error free or operate without interruption.

Fluke authorized resellers shall extend this warranty on new and unused products to end-user customers only but have no authority to extend a greater or different warranty on behalf of Fluke. Warranty support is available only if product is purchased through a Fluke authorized sales outlet or Buyer has paid the applicable international price. Fluke reserves the right to invoice Buyer for importation costs of repair/replacement parts when product purchased in one country is submitted for repair in another country.

Fluke's warranty obligation is limited, at Fluke's option, to refund of the purchase price, free of charge repair, or replacement of a defective product which is returned to a Fluke authorized service center within the warranty period.

To obtain warranty service, contact your nearest Fluke authorized service center to obtain return authorization information, then send the product to that service center, with a description of the difficulty, postage and insurance prepaid (FOB Destination). Fluke assumes no risk for damage in transit. Following warranty repair, the product will be returned to Buyer, transportation prepaid (FOB Destination). If Fluke determines that failure was caused by neglect, misuse, contamination, alteration, accident, or abnormal condition of operation or handling, including overvoltage failures caused by use outside the product's specified rating, or normal wear and tear of mechanical components, Fluke will provide an estimate of repair costs and obtain authorization before commencing the work. Following repair, the product will be returned to the Buyer transportation prepaid and the Buyer will be billed for the repair and return transportation charges (FOB Shipping Point).

THIS WARRANTY IS BUYER'S SOLE AND EXCLUSIVE REMEDY AND IS IN LIEU OF ALL OTHER WARRANTIES, EXPRESS OR IMPLIED, INCLUDING BUT NOT LIMITED TO ANY IMPLIED WARRANTY OF MERCHANTABILITY OR FITNESS FOR A PARTICULAR PURPOSE. FLUKE SHALL NOT BE LIABLE FOR ANY SPECIAL, INDIRECT, INCIDENTAL OR CONSEQUENTIAL DAMAGES OR LOSSES, INCLUDING LOSS OF DATA, ARISING FROM ANY CAUSE OR THEORY.

Since some countries or states do not allow limitation of the term of an implied warranty, or exclusion or limitation of incidental or consequential damages, the limitations and exclusions of this warranty may not apply to every buyer. If any provision of this Warranty is held invalid or unenforceable by a court or other decision-maker of competent jurisdiction, such holding will not affect the validity or enforceability of any other provision.

Fluke Corporation
6920 Seaway Blvd.
Everett, WA 98203
U.S.A.

Fluke Europe B.V.
P.O. Box 1186
5602 BD Eindhoven
The Netherlands

Table of Contents

Title	Page
Introduction.....	1
Contact Fluke	1
Safety Information	1
Product Overview	2
Auto Power Off.....	3
Auto Backlight Off.....	4
Measurements	4
Manual and Auto Range Selection.....	4
Data Hold.....	4
Relative Measurements (17B+ only)	4
MIN MAX Mode (17B+ Only)	5
Measure AC and DC Voltage	5
Measure AC or DC Current.....	6
Measure Resistance	6
Test for Continuity	7
Test Diodes	7
Measure Capacitance	8
Measure Temperature (17B+ only).....	8
Measure Frequency and Duty Cycle (17B+/18B+ Only).....	8
Hazardous Voltage Alert LED (17B+ Only).....	8
Test LEDs (18B+ Only).....	9
Maintenance	10
General Maintenance.....	10
Test Fuses	10
Replace Batteries and Fuses	11
Product Disposal.....	11
Service and Parts.....	12
General Specifications.....	12
Accuracy Specifications	13

Introduction

The Fluke 15B+/17B+/18B+ Digital Multimeters (the Product) are 4000 count instruments. The Product is battery powered with a digital display.

Except where noted, the descriptions and instructions in this Users Manual apply to all of 15B+/17B+/18B+.

Unless otherwise identified, all illustrations show the 17B+.

Contact Fluke

Fluke Corporation operates worldwide. For local contact information, go to our website: www.fluke.com.

To register your product, or to view, print, or download the latest manual or manual supplement, go to our website.

+1-425-446-5500 fluke-info@fluke.com

Safety Information

General Safety Information is in the printed Safety Information document that ships with the Product and at www.fluke.com. More specific safety information is listed where applicable.

A **Warning** identifies hazardous conditions and procedures that are dangerous to the user. A **Caution** identifies conditions and procedures that can cause damage to the Product or the equipment under test.

Review the safety information and comply with the safe working practices.

Product Overview

Table 1 shows the terminals on the Product.

Table 1. Terminals

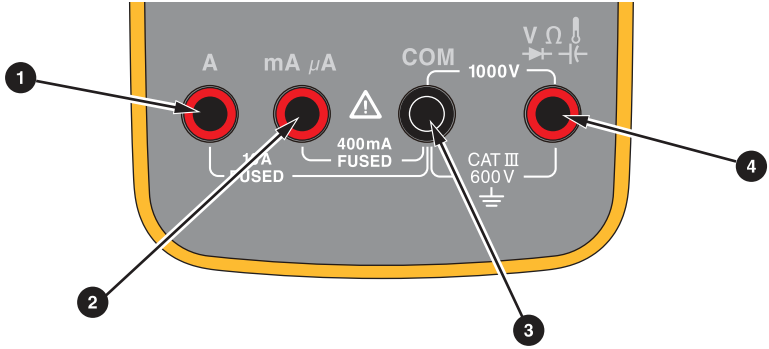

Item	Description
1	Input terminal for ac and dc current measurement to 10 A and frequency (17B+/18B+) measurements.
2	Input terminal for ac and dc microamp and milliamp measurements to 400 mA and frequency (17B+/18B+) measurements.
3	Common (return) terminal for all measurements.
4	Input terminal for voltage, resistance, continuity, diode, capacitance, frequency (17B+/18B+), duty cycle (17B+/18B+), temperature (17B+ only), and LED test (18B+ only) measurements.

Table 2 shows the display of the Product.

Table 2. Display

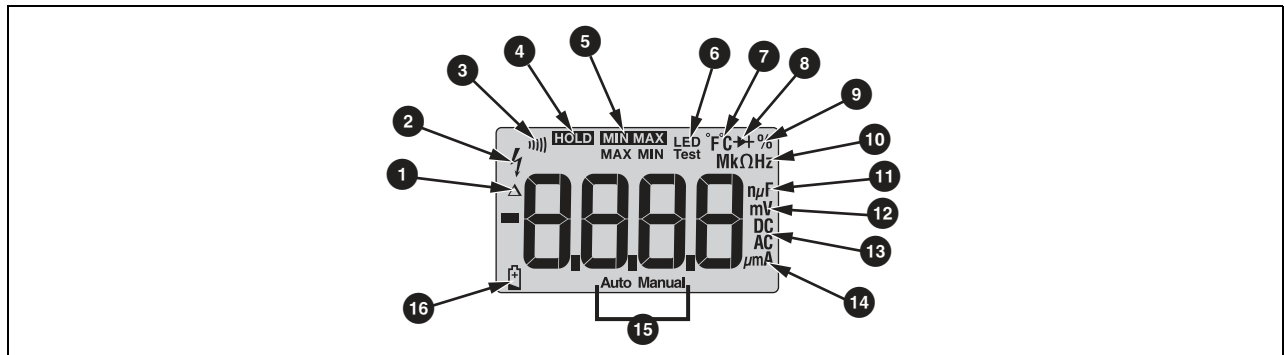

Item	Description	Item	Description
1	Relative measurement is enabled (17B+ only).	9	Duty cycle is selected (17B+/18B+).
2	High voltage	10	Resistance or Frequency (17B+/18B+) is selected.
3	Continuity is selected.	11	Farads for capacitance.
4	Display Hold is enabled.	12	millivolts or volts
5	MIN or MAX mode is enabled (17B+ only).	13	dc or ac voltage or current
6	LED test is enabled (18B+ only).	14	microamp, milliamp, or amp
7	Fahrenheit or Celsius is selected (17B+ only).	15	Auto range mode or Manual range mode is enabled.
8	Diode test is selected.	16	Battery is low and should be replaced.

Auto Power Off

The Product automatically powers off after 20 minutes of inactivity.

To restart the Product, turn the rotary switch back to the OFF position and then to a necessary position.

To disable the Auto Power Off function, hold down when turning on the Product, until **PaFF** shows on the display.

Note

*When you disable the Auto Power Off function, **LoFF** also shows on the display. The Auto Backlight Off function is also disabled.*

Auto Backlight Off

The backlight automatically turns off after 2 minutes of inactivity.

To disable the Auto Backlight Off function, hold down  when turning on the Product, until LoFF shows on the display.

Measurements

Warning

To prevent possible electrical shock, fire, or personal injury, disconnect power and discharge all high-voltage capacitors before you measure resistance, continuity, capacitance, or a diode junction.

Manual and Auto Range Selection

The Product has both manual and auto range options. In the auto range mode, the Product selects the best range for the input detected. This allows you to switch test points without having to reset the range. You can override auto ranging by selecting the range manually.

By default, the Product uses the auto range mode in measurement functions that have more than one range and shows **Auto Range** on the display.

To enter the manual range mode, push .

Note

Each push of  increments the range. When the highest range is reached, the Meter wraps to the lowest range.

To exit the manual range mode, push and hold  for two seconds.

Data Hold

Warning

To prevent possible electrical shock, fire or personal injury, do not use the HOLD function to measure unknown potentials. When HOLD is turned on, the display does not change when a different potential is measured.

To hold the present reading, push . Push  again to resume normal operation.

Relative Measurements (17B+ only)

The Product allows relative measurements for all functions except frequency, resistance, continuity, duty cycle, and diode.

To do relative measurements:

1. With the Product in the desired function, touch the test leads to the circuit on which you want future measurements to be based.

2. Push **REL** to store the measured reading as the reference value and activate the relative measurement mode.

The difference between the reference value and subsequent reading shows on the display.

3. Push **REL** for to return to normal operation.

MIN MAX Mode (17B+ Only)

To set the Product to MIN MAX mode (available for all functions except resistance, capacitance, frequency, duty cycle, and diode):

1. Push **MIN MAX** once to set the Product to MAX mode.
2. Push **MIN MAX** again to set the Product to MIN mode.
3. Push **MIN MAX** for 2 seconds to return to normal operation.

Measure AC and DC Voltage

To measure ac and dc voltage:

1. Turn the rotary switch to \tilde{V} , \bar{V} , or $\frac{\approx}{mV}$ to choose ac or dc.
2. Push **□** to toggle between mVac or mVdc voltage measurement.
3. Connect the red test lead to the $\frac{V}{\approx}$ terminal and the black test lead to the **COM** terminal.
4. Touch the probes to the correct test points of the circuit to measure the voltage, as shown in [Figure 1](#).
5. Read the measured voltage on the display.

Figure 1. Measure AC and DC Voltage

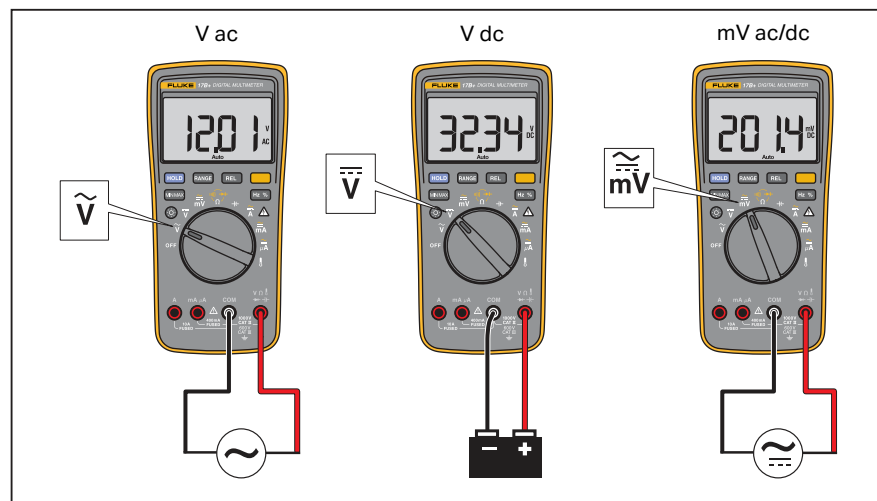

Measure AC or DC Current

⚠⚠ Warning

To prevent possible electrical shock, fire, or personal injury, remove circuit power before you connect the Product in the circuit when you measure current. Connect the Product in series with the circuit.

To measure ac or dc current:

1. Turn the rotary switch to \tilde{A} , \tilde{mA} , or $\tilde{\mu A}$.
2. Push \square to toggle between ac or dc current measurement.
3. Connect the red test lead to the A or mA μA terminal based on the current to be measured and connect the black test lead to the COM terminal. See [Figure 2](#).
4. Break the circuit path to be measured. Then connect the test leads across the break and apply power.
5. Read the measured current on the display.

Figure 2. Measure AC and DC Current

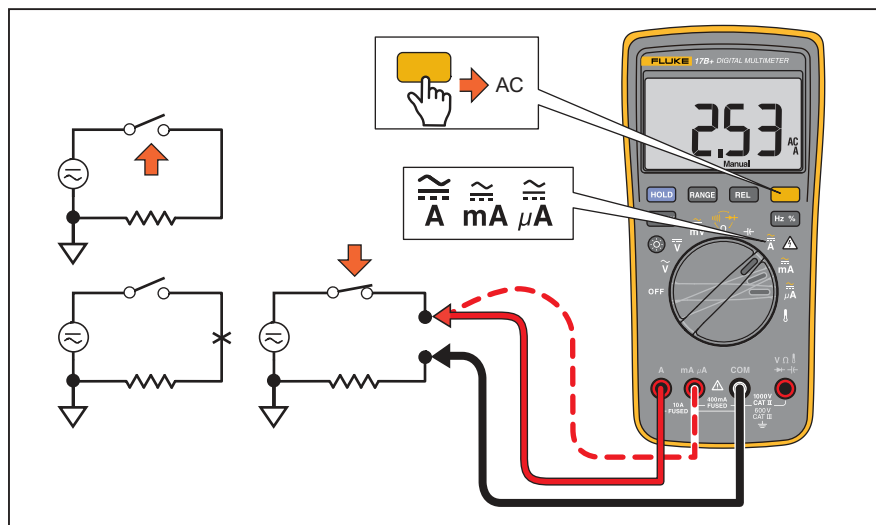

Measure Resistance

To measure resistance:

1. Turn the rotary switch to Ω . Make sure power is disconnected from the circuit to be measured.
2. Connect the red test lead to the Ω terminal and the black test lead to the COM terminal, as shown in [Figure 3](#).
3. Measure the resistance by touching the probes to the desired test points of the circuit.
4. Read the measured resistance on the display.

Test for Continuity

To test for continuity:

1. With the resistance mode selected, push  once to activate the continuity beeper.
If the resistance is $<70 \Omega$, the beeper will sound continuously, designating a short circuit.
2. See [Figure 3](#).

Figure 3. Measure Resistance/Continuity



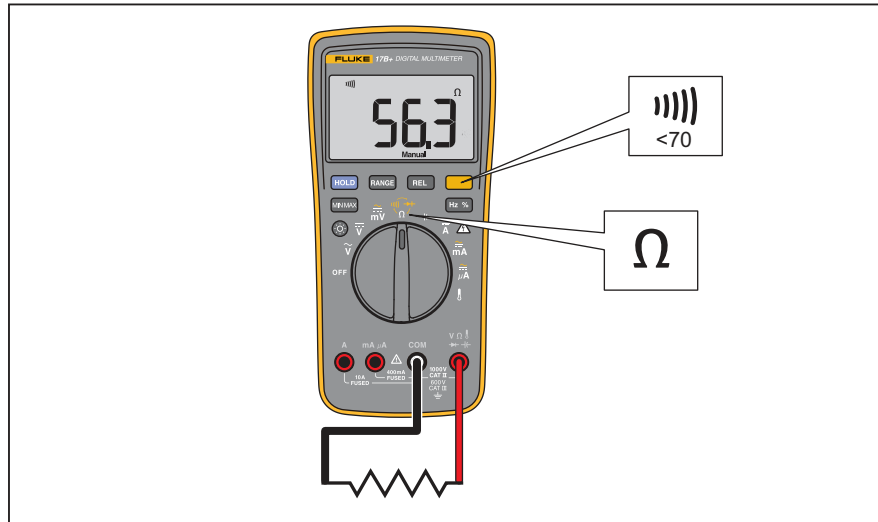

Test Diodes

Caution

To prevent possible damage to the Product or to the equipment under test, disconnect circuit power and discharge all high-voltage capacitors before you test diodes.

To test:

1. Turn the rotary switch to .
2. Push  twice to activate Diode Test.
3. Connect the red test lead to the V_{Ω} terminal and the black test lead to the **COM** terminal.
4. Connect the red probe to the anode side and the black test lead to the cathode side of the diode being tested.
5. Read the forward bias voltage value on the display.

If the polarity of the test leads is reversed with diode polarity, the display reading shows Ω . This can be used to distinguish the anode and cathode sides of a diode.

Measure Capacitance

Caution

To prevent damage to the Product, disconnect circuit power and discharge all high-voltage capacitors before you measure capacitance.

To measure:

1. Turn the rotary switch to V_{Ω} .
2. Connect the red test lead to the V_{Ω} terminal and the black test lead to the COM terminal.
3. Touch the probes to the capacitor leads.
4. After allowing the reading to stabilize (up to 18 seconds), read the capacitance value on the display.

Measure Temperature (17B+ only)

To measure temperature:

1. Turn the rotary switch to V_{Ω} .
2. Plug the thermocouple into the V_{Ω} and **COM** terminals of the Product.
3. Ensure that the thermocouple plug marked with "+" is inserted into the V_{Ω} terminal on the Product.
4. Read the temperature on the display.
5. Push to switch between °C and °F.

Measure Frequency and Duty Cycle (17B+/18B+ Only)

The Product can measure frequency or duty cycle while making either a voltage or a current measurement. Push to change the Product to frequency or duty cycle.

To measure:

1. When the Product is in the required function (ac voltage or ac current), push .
2. Read the frequency of the signal on the display.
3. To make a duty cycle measurement, push again.
4. Read the percent of duty cycle on the display.

Hazardous Voltage Alert LED (17B+ Only)

To alert you to the presence of a potentially hazardous voltage, when the Product detects a voltage ≥ 30 V or a voltage overload (OL), the Hazardous voltage alert LED () below turns on (17B+ only).

Note

The hazardous voltage alert LED turns on at Frequency/Duty cycle test when the Product is in the voltage functions (volts ac/dc and millivolts).

Test LEDs (18B+ Only)

⚠ Caution

To prevent possible damage to the Product or to the equipment under test, disconnect all test leads from any hazardous voltage before you switch to the LED TEST function.

The Product tests Light Emitting Diodes (LEDs) either through the LED test socket on the Meter or through the test leads.

Note

Do not use the LED Test mode to do LED aging tests.

To test an LED mounted in the test socket:

1. Turn the rotary switch to LED TEST.
2. Place the leads of the LED into the holes of the LED test socket on the front of the Meter as shown in [Figure 4](#).

If the LED is good, the Product will illuminate the LED under test and an anode indicator will illuminate to indicate the (+) pin. If the LED is broken, the LED will not illuminate and neither of the anode indicators will illuminate. If the LED is a short circuit, the LED will not illuminate, and both anode indicators will illuminate.

Figure 4. LED Test Sockets

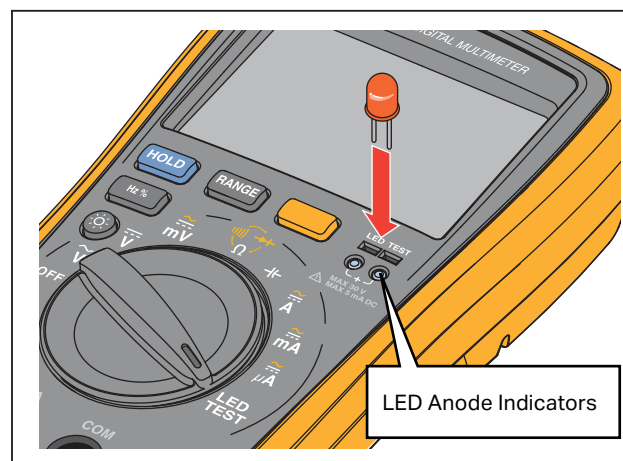

Maintenance

Beyond replacing batteries and fuses, do not attempt to repair or service the Product unless you are qualified to do so and have the relevant calibration, performance test, and service instructions. The recommended calibration cycle is 12 months.

Warning

To prevent possible electrical shock, fire, or personal injury:

- Remove the input signals before you clean the Product.
- Use only specified replacement fuses.
- Have an approved technician repair the Product.

For safe operation and maintenance of the Product:

- Repair the Product before use if the batteries leak.
- Batteries contain hazardous chemicals that can cause burns or explode. If exposure to chemicals occurs, clean with water and get medical aid.

General Maintenance

Periodically wipe the case with a damp cloth and mild detergent. Do not use abrasives or solvents. Dirt or moisture in the terminals can affect readings.

To clean the terminals:



1. Turn the Product off and remove the test leads.
2. Shake out any dirt that may be in the terminals.
3. Soak a new swab with isopropyl alcohol and work around the inside of each input terminal.

Test Fuses

Warning

To prevent electric shock or injury, remove the test leads and any input signals before replacing the fuses.

To test:

1. Turn the rotary switch to .
2. Plug a test lead into the  terminal and touch the probe to the **A** or **mA/μA** terminal.
 - A good **A** terminal fuse reads approximately 0.1 Ω. A good **mA/μA** terminal fuse reads less than 10 kΩ.
 - If the display reads , replace the fuse and test again.
 - If the display shows any other value, have the Product serviced. See [Service and Parts](#).

Replace Batteries and Fuses

⚠⚠ Warning

To prevent false readings, which could lead to possible electric shock or personal injury, replace the batteries as soon as the battery indicator (🔋) appears.

To prevent damage or injury, install **ONLY** replacement fuses with the specified amperage, voltage, and interrupt ratings.

Disconnect test leads before opening the case or the battery door.

To replace the batteries or the fuses, see [Figure 5](#).

Figure 5. Replace Batteries and Fuses

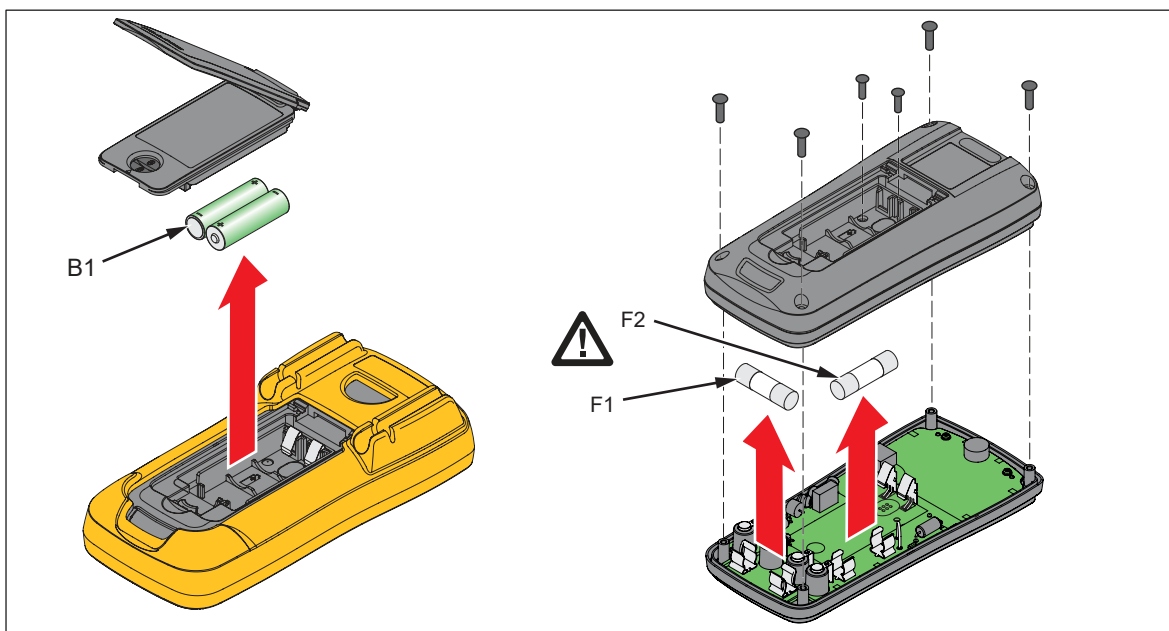

Product Disposal

Dispose of the Product in a professional and environmentally sound manner:

- Delete personal data on the Product before disposal.
- Remove batteries that are not integrated into the electrical system before disposal and dispose of batteries separately.
- If this Product has an integral battery, put the entire Product in the electrical waste.

Service and Parts

If the Product fails, first check the batteries and fuse, and then review this manual to make sure that you are operating the Product correctly.

Replacement parts are listed in [Table 3](#).

Table 3. Replacement Parts

Item Description	Part Number
Battery, IEC LR6	376756
Battery door assembly, English	4413666
Battery door assembly, Chinese	4413653
TL75-4201, test leads with two caps	4306653
Fuse, 0.440 A, 1000 V, FAST	943121
Fuse, 11A, 1000 V, FAST	803293
Holster	4368113

General Specifications

Display (LCD).....	4000 counts, updates 3/sec
Battery Life	500 hours minimum (50 hours in LED Test mode without load. The hours with load depends on the type of LED under test.)
Temperature Coefficient.....	0.1 X (specified accuracy) /°C (<18 °C or >28 °C)
Size (HxWxL).....	183 mm x 91 mm x 49.5 mm
Weight	455 g

Accuracy Specifications

Accuracy is specified for 1 year after calibration, at operating temperatures of 18 °C to 28 °C, relative humidity at 0 % to 75 %. Accuracy specifications take the form of: \pm ([% of Reading] + [Number of Least Significant Digits]).

AC and DC Voltage

Function	Range	Resolution	Accuracy		
			15B+	17B+	18B+
AC Volts (40 Hz – 500 Hz) ^[1] \tilde{V}	4.000 V	0.001 V	1.0 % + 3	1.0 % + 3	1.0 % + 3
	40.00 V	0.01 V			
	400.0 V	0.1 V			
	1000 V	1 V			
AC Millivolts \tilde{mV}	400.0 mV	0.1 mV	3.0 % + 3	3.0 % + 3	3.0 % + 3
DC Millivolts $\overline{\overline{mV}}$	400.0 mV	0.1 mV	1.0 % + 10	1.0 % + 10	1.0 % + 10
DC Volts $\overline{\overline{V}}$	4.000 V	0.001 V	0.5 % + 3	0.5 % + 3	0.5 % + 3
	40.00 V	0.01 V			
	400.0 V	0.1 V			
	1000 V	1 V			
[1] All ac, Hz, and duty cycle are specified from 1 % to 100 % of range. Inputs below 1 % of range are not specified.					

AC and DC Current

Function	Range	Resolution	Accuracy		
			15B+	17B+	18B+
AC Current μA (40 Hz – 400 Hz) $\tilde{\mu A}$	400.0 μA	0.1 μA	1.5 % + 3	1.5 % + 3	1.5 % + 3
	4000 μA	1 μA			
AC current mA (40 Hz – 400 Hz) \tilde{mA}	40.00 mA	0.01 mA	1.5 % + 3	1.5 % + 3	1.5 % + 3
	400.0 mA	0.1 mA			
AC current A ^[1] (40 Hz – 400 Hz) \tilde{A}	4.000 A	0.001 A	1.5 % + 3	1.5 % + 3	1.5 % + 3
	10.00 A	0.01 A			
DC current μA $\overline{\overline{\mu A}}$	400.0 μA	0.1 μA	1.5 % + 3	1.5 % + 3	1.5 % + 3
	4000 μA	1 μA			
DC current mA $\overline{\overline{mA}}$	40.00 mA	0.01 mA	1.5 % + 3	1.5 % + 3	1.5 % + 3
	400.0 mA	0.1 mA			
DC current A ^[1] $\overline{\overline{A}}$	4.000 A	0.001 A	1.5 % + 3	1.5 % + 3	1.5 % + 3
	10.00 A	0.01 A			
[1] 10 A duty cycle <7 minutes on, 20 minutes off.					

Diode Test, Temperature, Resistance, Capacitance, Frequency, and Duty Cycle

Function	Range	Resolution	Accuracy		
			15B+	17B+	18B+
Diode Test ^[1] ➔	2.000 V	0.001 V	10 %		
Temperature 🌡️	50.0 °C to 400.0 °C	0.1 °C	NA	2 % +1 °C	NA
	0 °C to 50.0 °C			2 °C	
	-55.0 °C to 0 °C			9 % +2 °C	
Resistance (Ohms) Ω	400.0 Ω	0.1 Ω	0.5 % + 3	0.5 % + 3	0.5 % + 3
	4.000 kΩ	0.001 kΩ	0.5 % + 2	0.5 % + 2	0.5 % + 2
	40.00 kΩ	0.01 kΩ	0.5 % + 2	0.5 % + 2	0.5 % + 2
	400.0 kΩ	0.1 kΩ	0.5 % + 2	0.5 % + 2	0.5 % + 2
	4.000 MΩ	0.001 MΩ	0.5 % + 2	0.5 % + 2	0.5 % + 2
	40.00 MΩ	0.01 MΩ	1.5 % + 3	1.5 % + 3	1.5 % + 3
Capacitance ^[2] ⚡	40.00 nF	0.01 nF	2 % + 5	2 % + 5	2 % + 5
	400.0 nF	0.1 nF	2 % + 5	2 % + 5	2 % + 5
	4.000 μF	0.001 μF	5 % + 5	5 % + 5	5 % + 5
	40.00 μF	0.01 μF	5 % + 5	5 % + 5	5 % + 5
	400.0 μF	0.1 μF	5 % + 5	5 % + 5	5 % + 5
	1000 μF	1 μF	5 % + 5	5 % + 5	5 % + 5
Frequency ^[3] (10 Hz to 100 kHz) Hz	50.00 Hz	0.01 Hz	NA	0.1 % + 3	0.1 % + 3
	500.00 Hz	0.1 Hz			
	5.000 kHz	0.001 kHz			
	50.00 kHz	0.01 kHz			
	100.0 kHz	0.1 kHz			
Duty Cycle ^[2]	1 % to 99 %	0.1 %	NA	1 % typical ^[4]	1 % typical ^[4]
<p>[1] Typically, open circuit test voltage is 2.0 V and short circuit current is <0.6 mA.</p> <p>[2] Specifications do not include errors due to test lead capacitance and capacitance floor (may be up to 1.5 nF in the 40 nF range).</p> <p>[3] All ac, Hz, and duty cycle are specified from 1 % to 100 % of range. Inputs below 1 % of range are not specified.</p> <p>[4] Typical means when the frequency is at 50 Hz or 60 Hz and the duty cycle is between 10 % and 90 %.</p>					

LED Test and Continuity Threshold

Function	Lighting Range	Measurement Range	Resolution	Accuracy
LED V_F Test ^[1] (LED Test Socket)	1.00 to 6.00 V	NA	NA	NA
LED V_F Test ^[2] (Test Leads)	1.00 to 6.00 V	1.00 to 6.00 V	0.01 V	10 %
Continuity Threshold	NA	NA	NA	70 Ω
[1] Open circuit test voltage is ± 12 V and short-circuit current is $< \pm 5$ mA (typical). [2] Open circuit test voltage is ± 12 V and short-circuit current is $< \pm 3$ mA (typical). [3] V_F measurement with driving current under 2.2 ± 0.4 mA.				

Input Characteristics

Function	Overload Protection	Input Impedance (Nominal)	Common Mode Rejection Ratio	Normal Mode Rejection Ratio
AC Volts	1000 V ^[1]	> 10 M Ω , < 100 pF	> 60 dB at dc, 50 Hz or 60 Hz	--
AC Millivolts	400 mV	> 1 M Ω , < 100 pF	> 80 dB at dc, 50 Hz or 60 Hz	--
DC Volts	1000 V ^[1]	> 10 M Ω , < 100 pF	> 100 dB at dc, 50 Hz or 60 Hz	> 60 dB at dc, 50 Hz or 60 Hz
DC Millivolts	400 mV	> 1 M Ω , < 100 pF	> 80 dB at dc, 50 Hz or 60 Hz	--
[1] 10^6 V Hz Max				

