



1700mm P-51D Mustang

Operating Manual



Specifications

Wingspan.....	1700mm/66.9in
Length.....	1480mm/58.3in
Weight.....	4080g(144oz)
Wing Area.....	52.1dm ² (807.6/in ²)
Wing Load.....	78.3 g/dm ² (0.18oz/in ²)
Radio Controls.....	6 Channel



<http://www.facebook.com/FMSmodel>



www.fmsmodel.com

Please visit both our Facebook fanpage and our homepage for updated product information

WARNING

 **WARNING:** Read the ENTIRE instruction manual to become familiar with the features of the product before operating. Failure to operate the product correctly can result in damage to the product, personal property and cause serious injury.

This is a sophisticated hobby product and NOT a toy. It must be operated with caution and common sense and requires some basic mechanical ability. Failure to operate this Product in a safe and responsible manner could result in injury or damage to the product or other property. This product is not intended for use by children without direct adult supervision.

This manual contains instructions for safety, operation and maintenance. It is essential to read and follow all the instructions and warnings in manual, prior to assembly, setup or use, in order to operate correctly and avoid damage or serious injury.

Safety Precautions and Warnings

As the user of this product, you are solely responsible for operating in a manner that does not endanger yourself and others or result in damage to the product or the property of others. This model is controlled by a radio signal subject to interference from many sources outside your control. This interference can cause momentary loss of control so it is advisable to always keep a safe distance in all directions around your model, as this margin will help avoid collisions or injury.

Age Recommendation: Not for children under 14 years. This is not a toy.

- Never operate your model with low transmitter batteries.
- Always operate your model in an open area away from cars, traffic or people.
- Avoid operating your model in the street where injury or damage can occur.
- Never operate the model in the street or in populated areas for any reason.
- Carefully follow the directions and warnings for this and any optional support equipment (chargers, rechargeable battery packs, etc.) you use.
- Keep all chemicals, small parts and anything electrical out of the reach of children.
- Moisture causes damage to electronics. Avoid water exposure to all equipment not specifically designed and protected for this purpose.
- Never lick or place any portion of your model in your mouth as it could cause serious injury or even death.

FMS Kindly Reminder



Thank you for purchasing a FMS model product. Our goal is to provide high quality products and offer great customer service. If you have any problems with your product or want to offer suggestions for improvements (such as plane design, packaging, building instructions, etc.) please feel free to contact us at info@fmsmodel.com

Table of contents

Kit contents	1
The spare parts list	
Spare parts list content	
The illustration of the spare parts	
Charging the Flight Battery	4
Low Voltage Cut off (LVC)	
Installing the control horn	5
Mount the main wing	7
Install the horizontal stabilizer and the vertical fin	9
Electronics installation and set-up	10
Bind the receiver to the transmitter	
Install the receiver	
Install the Battery	
Hook on the linkage rod of the stabilizer	
Installing the linkage rod	
Test the stabilizer control servos	
Main wing assembly, set-up and installation	14
Install main wing the control rod	
Install the Machine gun set and exhaust stack	15
Install the oil tank	16
Final assembly and set-up procedures	17
Important ESC and model information	
Final assembly and set-up procedures	18
The transmitter and model setup	
Check the control throws	
Installing the propeller	
Install the propeller set	
Final assembly and set-up procedures	24
Check the C.G. (Center of Gravity)	
ESC instruction	25

Kit contents



Kit contents

1. The fuselage assembly (With the motor, the canopy, the electronic parts, ESC)
2. Main wing (With all electric device installed)
3. Horizontal stabilizer with elevator joiner installed
4. canopy (with pilot)
5. Propeller, spinner set, and the antenna mast
6. Spare parts bag
7. Fuel tank

The spare parts list

Replacement parts for the **FMS 1700MM P-51D** are available using the order numbers in the Spare parts list that follows. The fastest, most economical service can be provided by your hobby dealer or mail-order company.

Spare parts list content

- SG101-RT Fuselage
- SG102-RT Main wing (A pair of wing with the gear base installed)
- SG103-RT Vertical stabilizer
- SG104-RT Horizontal stabilizer
- SG105-RT Cowl
- SG106-RT V2 Spinner
- SG107-RT Canopy
- SG108 Cockpit (Foam cockpit hatch)
- SG109 Oil tank (A pair of identical oil tank)
- SG206 Rear retract
- SG207 Main landing gear strut (A pair of main landing gear struts with the wheels installed)

Spare Parts List

- SG208 Main landing gear system (A pair of retracts with strut and wheel installed)
- SG209 Rear landing gear system
- SG301 V2 Propeller (Four pieces blade)
- SG302 Linkage rod (All of the control surface linkage rod with clevis installed)
- SG303 Aluminum motor base (With four pieces sink head screw)
- SG304-RT Decal sheet
- SG305-RT The inner fairing door
- SG306-RT Rear landing gear hatch fairing door
- SG307 Screw set
- SG308 Motor board
- SG309 Motor shaft
- SG310 Plastic Scale Cockpit
- SG314 Pipe
- SG315-FF Outer fairing door
- SG316 LED
- SG317 Lamp cover
- FMS-Sequencer-6 sec P51
- FMS-Retract 002(For the main landing gear)
- FMS-Motor-5060 KV360
- FMS-ESC-85A 8A SBEC
- FMS-Servo-9g-Positive
- FMS-Servo-25g metal digital
- FMSCON001- Multi connector system



SG101-RT

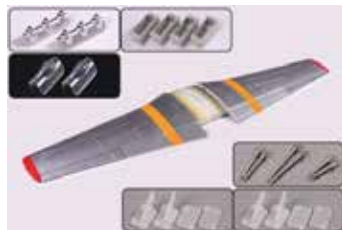

SG102-RT

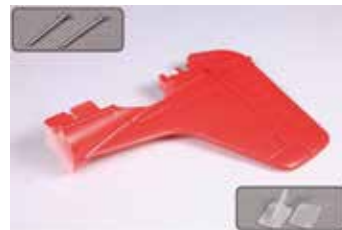

SG103-RT



SG104-RT



SG105-RT



SG106-RT V2



SG107-RT



SG108



SG109



SG206



SG207



SG208



SG209



SG301 V2



SG302



SG303

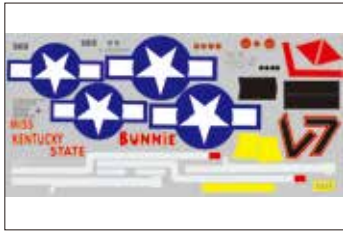

SG304-RT



SG305-RT



SG306-RT



SG307



SG308



SG309



SG310



SG314



SG315-FF



SG316



SG317



FMS-Sequencer-6 sec



FMS-Retract 002



FMS-Motor 5060 KV360



FMS-ESC-85A
8A SBEC



FMSSER9GP



FMSSER25MG



FMSCON001

Charging the Flight Battery

The Battery Charger is designed to safely charge the Li-Po battery,

Caution: All instructions and warnings must be followed exactly. Mishandling of Li-Po batteries can result in fire, personal injury, or property damage.

Battery warning:

- ◆ By handling, charging or using the included Li-Po battery you assume all risks associated with lithium batteries.
- ◆ If at any time the batteries begin to swell, or balloon, discontinue use immediately! Charging or discharging a swelling or ballooning battery can result in fire.
- ◆ Always store the batteries at room temperature in a dry area to extend the life of the battery. Always transport or temporarily store the battery in a temperature range of 40-120°F. Do not store battery or model in a car or in direct sunlight. If stored in a hot car, the battery can be damaged or even catch fire.
- ◆ Never use a Ni-Mh charger. Failure to charge the battery with a compatible charger may cause fire resulting in personal injury and property damage.
- ◆ Never discharge Li-Po cells to below 3V.
- ◆ Never leave charging batteries unattended.
- ◆ Never charge damaged batteries.

Charging the flight battery

When charging the battery, make certain the battery is on a heat-resistant surface, charge the battery before assembly of the airplane. Install the fully charged battery to perform control tests and binding.

Low voltage cut off(LVC)

When a Li-Po is discharged below 3V per cell, it will not hold a charge. The ESC protects the flight battery from over-discharge using Low Voltage Cutoff. Before the battery charge decreases too much, LVC removes power from motor in two ways: (1) Reduces power - ESC reduces motor power (recommended), (2) Hard cutoff - ESC instantly cuts motor power when the pre-set Low Voltage Protection Threshold value is reached. These settings can be changed using the ESC programming guide.

Installing the control horn

1. The control surface horns for the rudder and elevator are stapled to the bags containing the rudder and elevator, do not accidentally discard them.

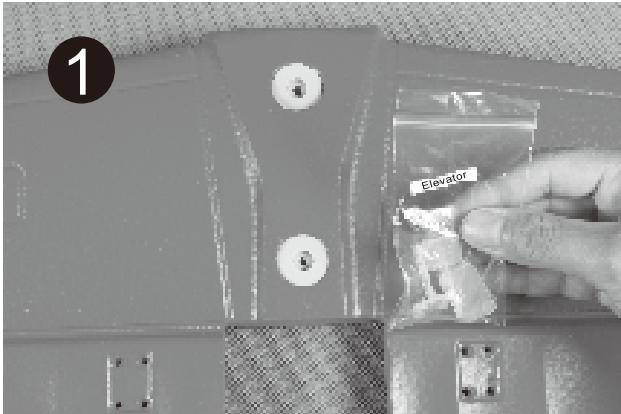

2. The top side of the elevator attached two plastic washer.

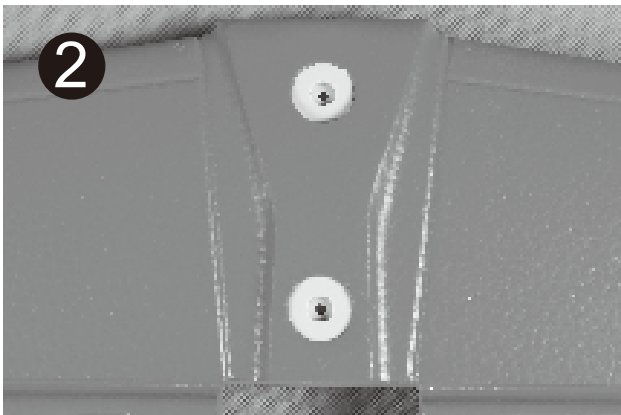

3. Install the elevator control surface horns on the bottom of the elevator surface with the screws provided in the small plastic bag. The side of the stabilizer that contains the nose faces down, make sure to install the control horns on this side. Make sure the control surface horns are facing into the right direction before installing.

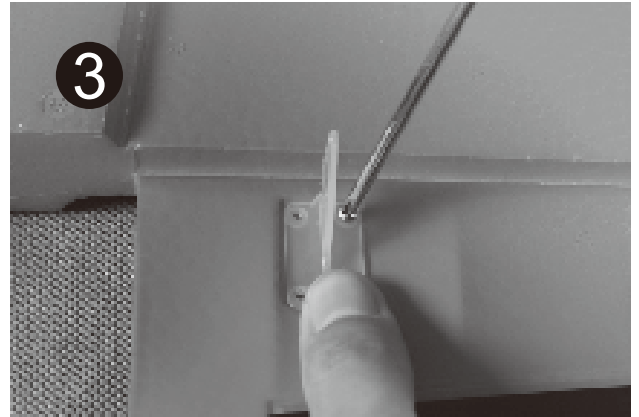

4. Attach the flap control horn on the servo side of the main wing with the horn towards the hinge line.



5. Secure the horn from the backplate side using the provided screws.

Note: No backplate used in this step or it will stop the flap from fully retract.

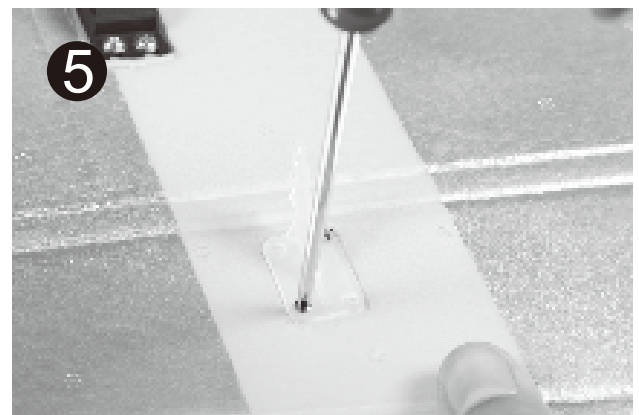

Installing the control horn

1. Install the aileron horn on the servo side of the main wing with the horn toward the hinge line as the picture shows.



2. Now attach the aileron surface control horns to the bottom of the lower main wing.



1. Attached the control horn to the starboard of the rudder with it toward the hinge line.

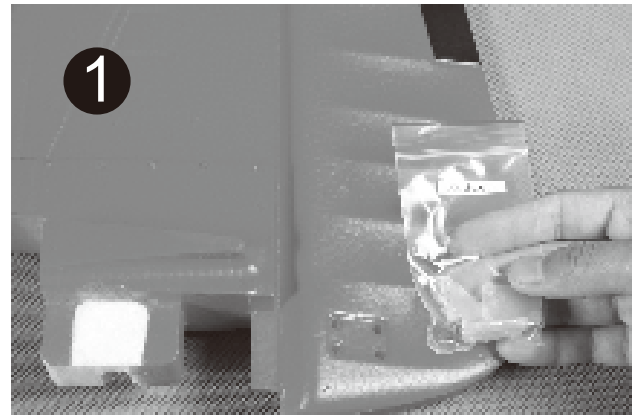

2. Secure the horn from the backplate side using the provided screws.
Note: The longer screws always locate on the leading edge side of all the control surface.

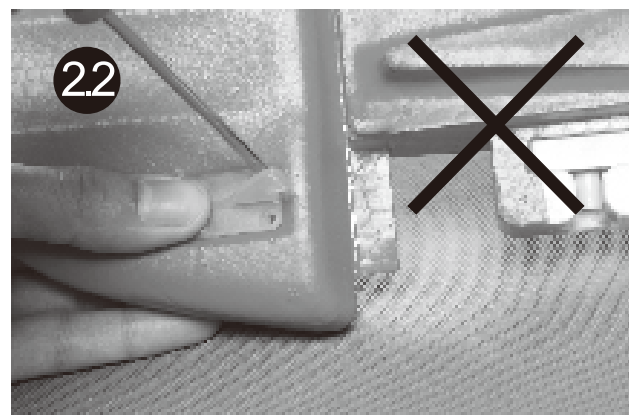
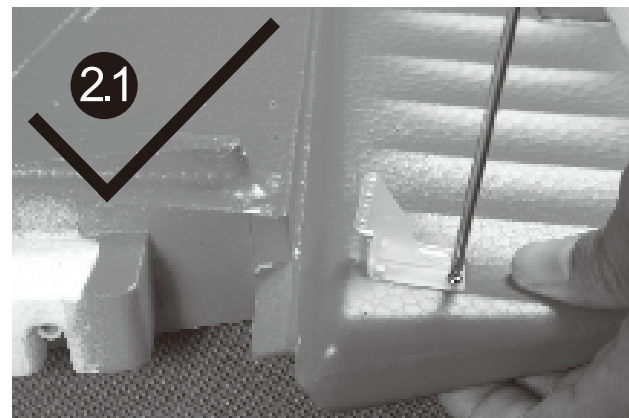

Mount the main wing

1. Insert the in stored fiberglass tube into the main wing trailing edge side socket.
Note: When sliding the tubes into the wings, they should go in easily. Do not push them farther than they will go with little resistance. That would push the wing tubes into the foam of the wing and prevent them from fully inserting into the opposite wing half. Insert the connecting tube till the white mark the factory pre spackled.

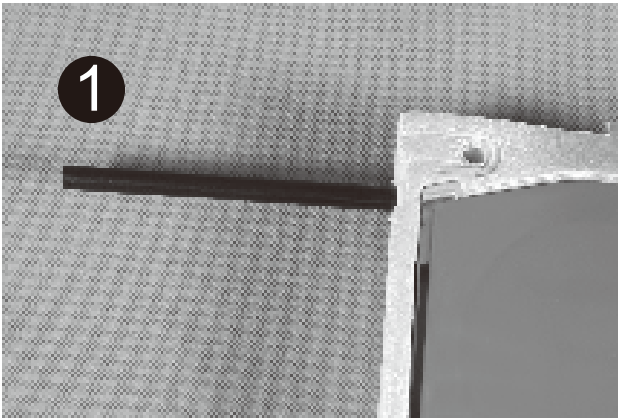

2. Insert the in stored pre bended Aluminium tube into the main wing leading edge side socket till the bend point.

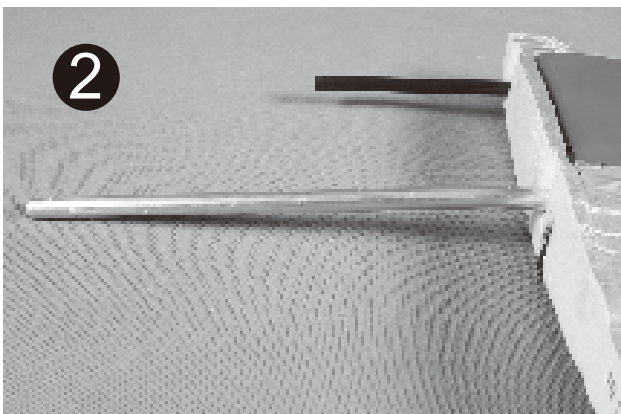

3. The two rods are parallel from the top view.
Note: the bended angle of the rod consistent with the main wing dihedral.
A. The shorter rod.
B. The longer aluminium rod.

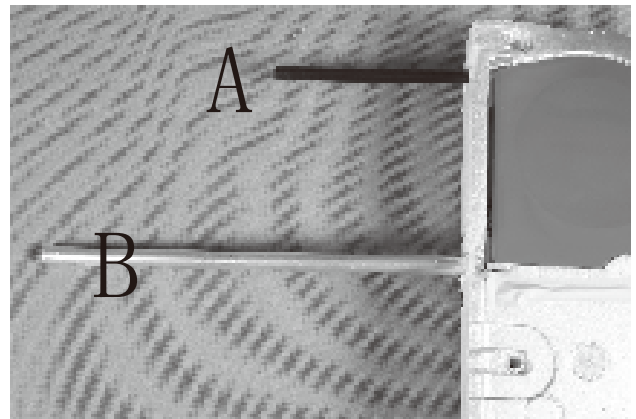

4. Connect the rest half wing to the rods, slide it in slightly. Make sure there is no slot between this two main wing panels. If not, you have to check the obstruction out.

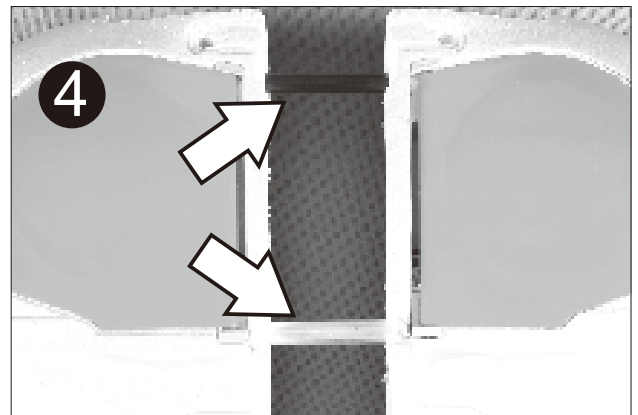

Mount the main wing

1. Seat wing to the wing bay by threading the leads from the hole at the bottom of the wing bay to the receiver hatch,



2. Make sure that you place the plate into the notch correctly.
The plate only fits right in one direction



3. Install the wing connector.
Note: Put the connector into the position rightly .Making sure there is no slot between the two wing panel.



4. Thread the bolt into the connector making sure it is tight enough.
(PM6.0*80 2PCS)



Install the horizontal stabilizer and the vertical fin

1. Attach the horizontal stabilizer first.
Mount the stabilizer into the pre-notched aft section of the fuselage with the top side face up.
Use two screws to secure it.
All of the measurements of the screws we have described in the manual has been tagged to the described spare parts bag.
Please refer to the measurements on the manual and the spare parts bag for the convenient usage.

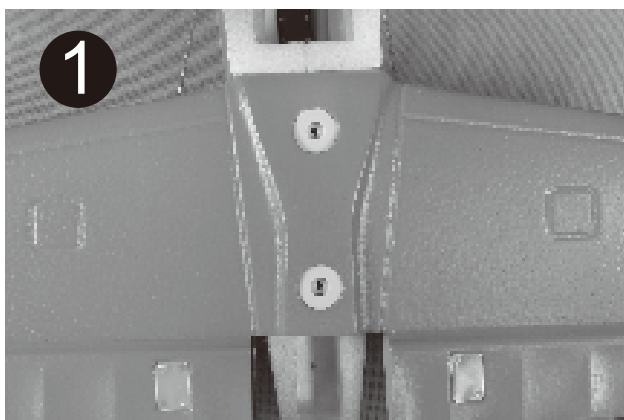

2. Make sure the horizontal stabilizer align with the fuselage. (PM 3.0*50 2PCS)

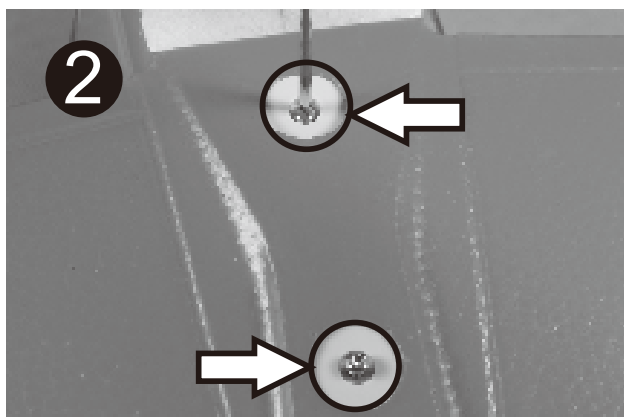

3. Now the vertical stabilizer is ready to be mounted. gently push the stabilizer down until it is fully seated with on gaps between it and the fuselage, it fits perfectly when properly pushed down.

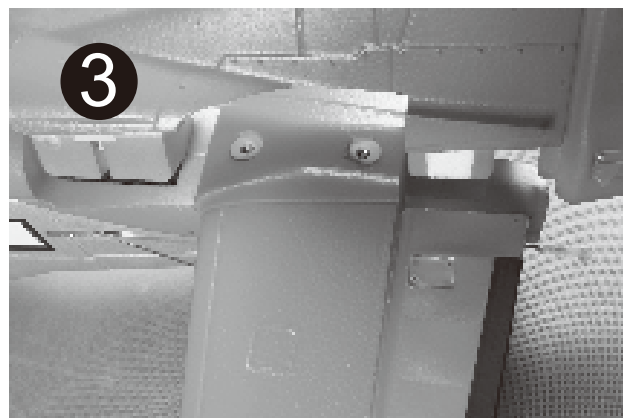

3. Secure the rudder using screws. (PM 3.0*60 3PCS)
Note: Keep the bolts straight into the hole and then into the nuts.

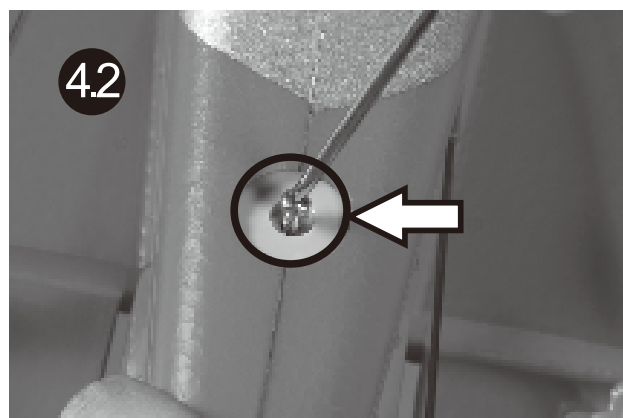
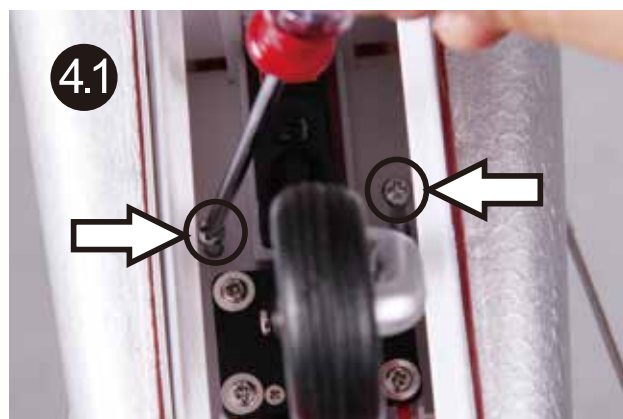

Electronics installation and set-up

Receiver connection diagram

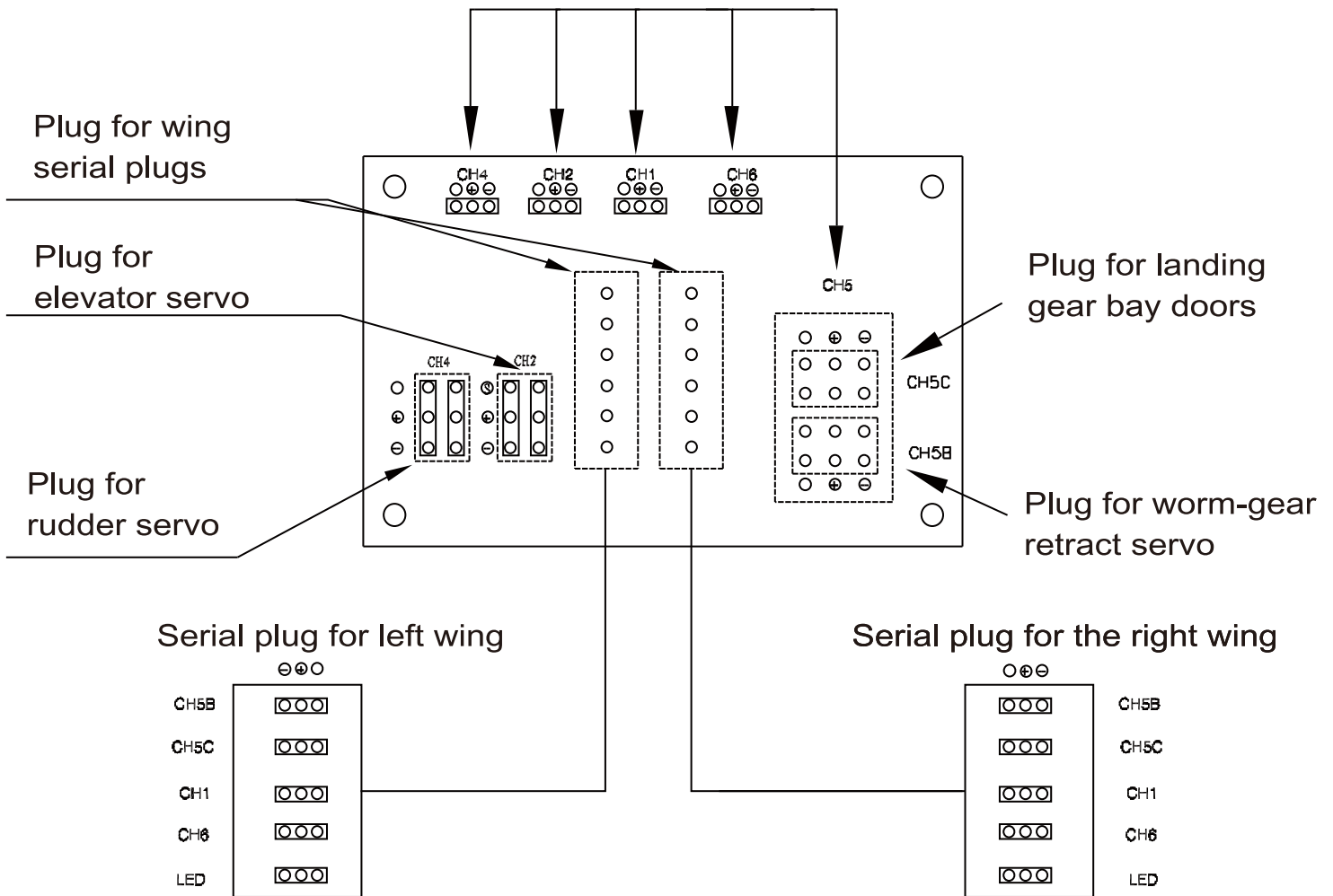

Electronics installation and set-up

Install the battery

1. Slide the battery into the battery hatch with the power supply cable toward the rear end of the plane and secure it using the pre installed hook and loop tape.
Note: You may need to relocate the battery position to achieve the correct CG for your model.



Hook on the linkage rod of the stabilizer

1. Loosen the screws on the control connector which are holding the rod into place.



Installing the linkage rod

2. Snap the clevis into the elevator surface control horn.

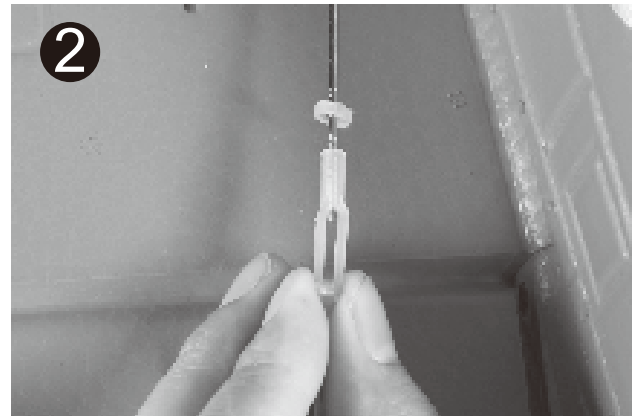

3. The provided piece of fuel tubing keeps the clevis closed during flight. Secure all the linkages the same way.
Note: Do not over slide the securing tube or it will impede the movement of the surface control horn. Install all of the linkages the same way.

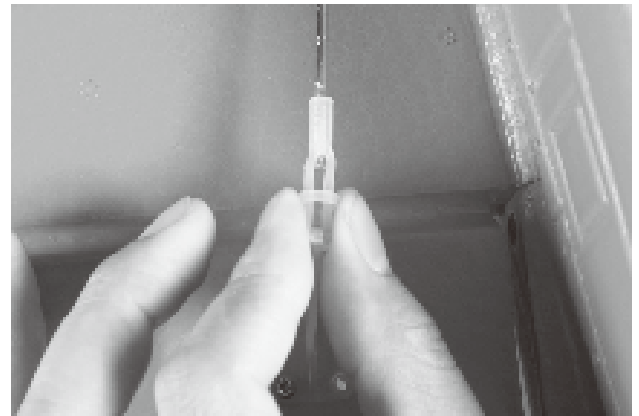

Electronics installation and set-up

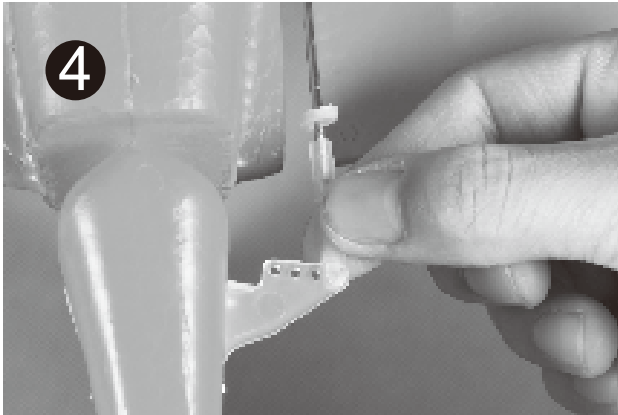

4. Deploy the gear and gear door before threading the front two bolts. (PM6.0*40 2PCS)

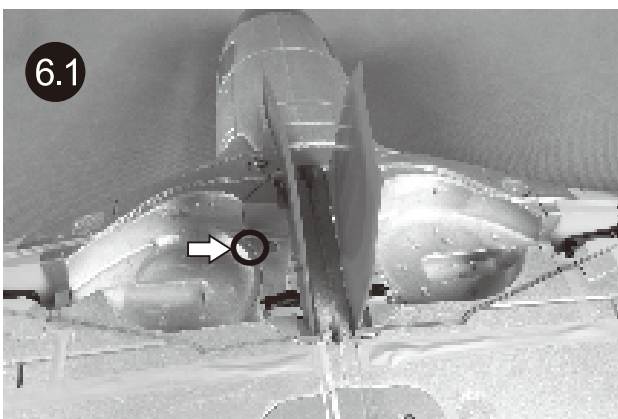

3. Check to make sure the stabilizer is standing fully vertical with the vertical fin. Adjust any misalignment before the glue dried thoroughly.

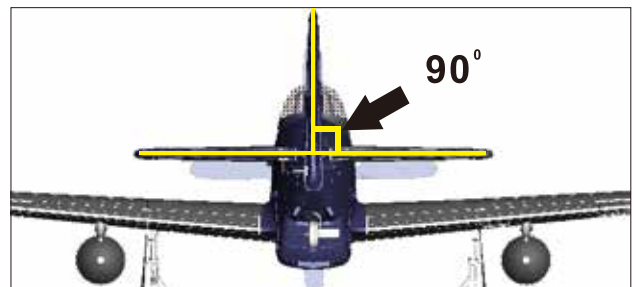

Test the stabilizer control servos

1. Make sure all the control sticks on your radio are in the neutral position (rudder, elevator, ailerons) and the throttle in the OFF position. Turn on the transmitter and power on the model, move the elevator and the rudder on the transmitter to make sure aircraft control surface move correctly. If controls respond in the opposite direction, reverse the direction for operation of flight controls.

Electronics installation and set-up

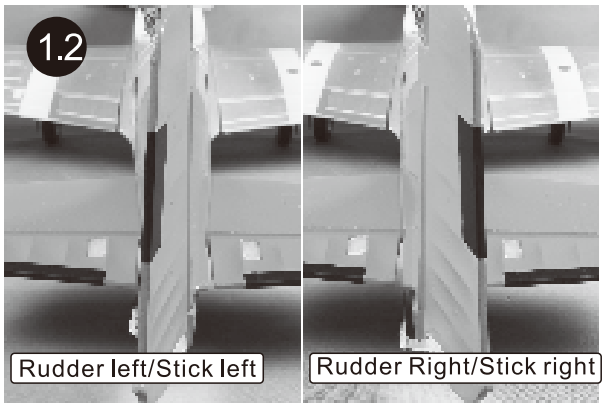
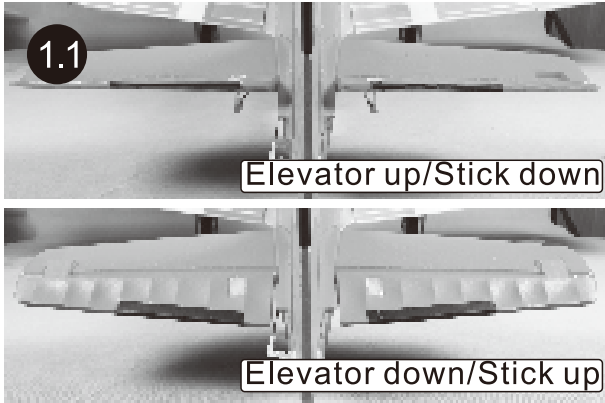

2. Make sure all the control surface trim in neutral position, for computerized transmitters, use the servo/channel sub-trim feature to make each servo arm fully vertical.

Note: Make sure the trims and the sub trims in neutral position before making some mechanically trim. Adjust the servo arms mechanically make sure all servo arms are as fully vertical with the servo case as possible. If not, adjust the servo arm by using the trim function on your radio.



3. Adjust the linkage in the control connector to make sure the counterbalance leading edge of the elevator and the rudder level with the leading edge of the horizon stabilizer and the vertical fin respectively.

Note: Use a drop of thread lock on the screw before secure the rod into place.

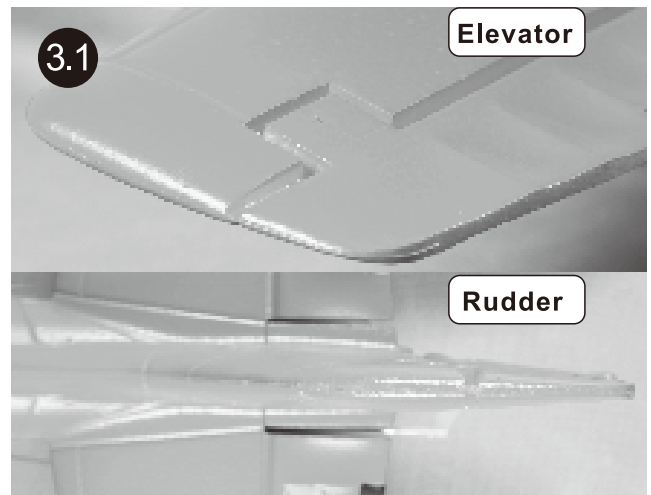

4. The motor should rotate counterclockwise when viewing the plane from the front. Or you will have to disconnect any two of the motor plugs and plug them back to each other's socket.

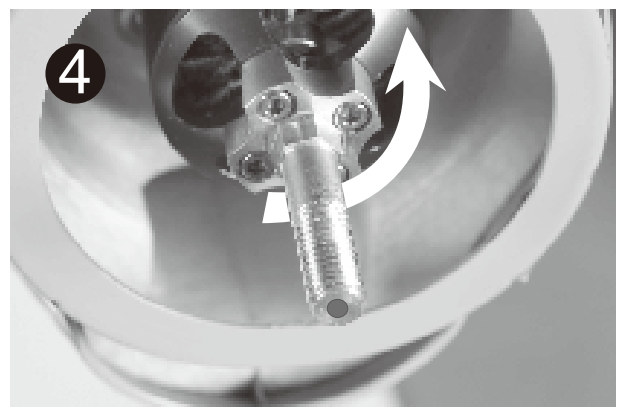

Main wing assembly, set-up and installation

Install main wing the control rod

1. The standard hole settings for linkage connections are shown by the black arrows in the diagram below. You can refer the recommended control throw setting to move the linkage to different hole positions to increase control surface travel and increase the aerobatics of the airplane.

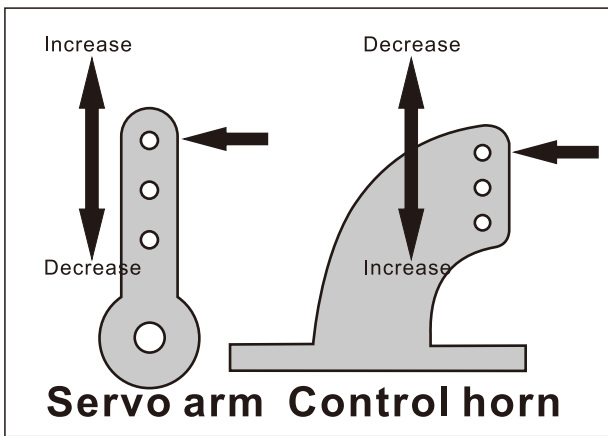

2. Make sure the aileron servo horns are fully vertical with the servo case and stick Input the aileron to make sure the servos functions well. Put the Z-bend end of the linkage into the desired servo control horn hole of the main-wing. It is a tight fit and should allow the linkage to move just slightly within the hole to avoid binding up. Hook on the clevis the same with the stabilizer.

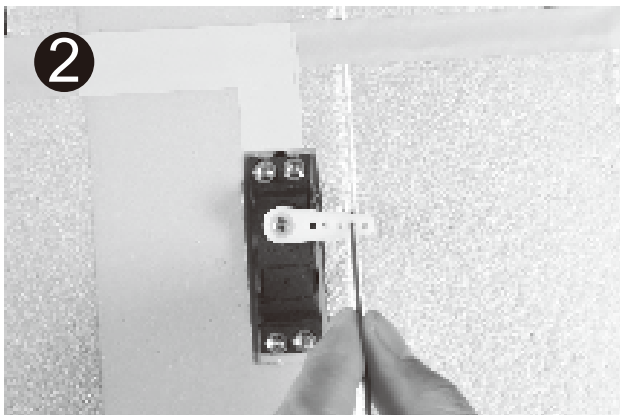

2. Slap the clevis into the surface control horn.



3. The provided piece of fuel tubing keeps the clevis closed during flight. Do all the linkages the same way in the model building process.



Install the Machine gun set and exhaust stack

1. Make sure the navigation light on port side(L) wing tip emitting red beams, the starboard(R) is green.

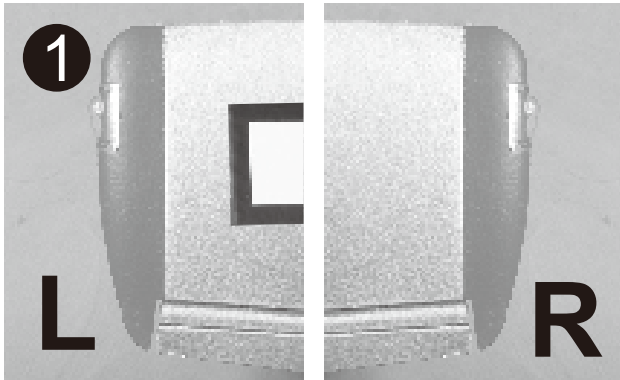

3. Take the set out and glue it back into place. Repeat the same steps for the other set install.



1. The machine gun set.



4. Apply glue on the combined side of the air exhaust stack.



2. Position one of the gun set in to place. will fit perfectly with the gun barrel toward straight forward. if not, you will have to change other one.



5. Install the air exhaust stack.
Note: Insert the front part of the stack into the concave part part of the cowl.



Install the oil tank

1. A pair of identical oil tank.

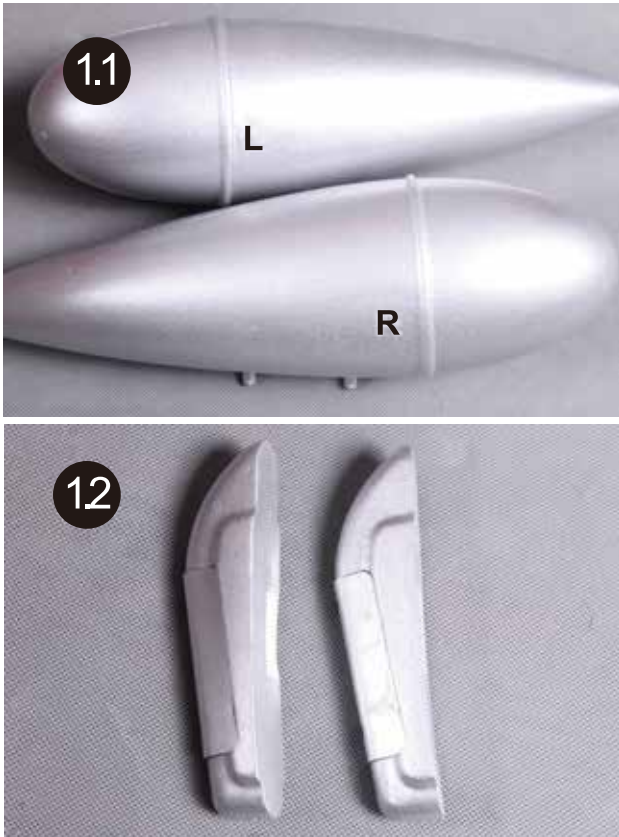

2. Apply glue on the combined side of the drop tank rack then stick the rack into the slot properly.



3. Install the drop tanks (2pcs)



Final assembly and set-up procedures

Important ESC and model information

1. The ESC included with the **P-51** has a safe start. If the motor battery is connected to the ESC and the throttle stick is not in the low throttle or off position, the motor will not start until the throttle stick is moved to the low throttle or off position. Once the throttle stick is moved to the low throttle or off position, the motor will emit a series of beeps. Several beeps with the same tune means the ESC has detected the cells of the battery. The count of the beeps equals the cells of the battery. The motor is now armed and will start when the throttle is moved.
2. The motor and ESC come pre-connected and the motor rotation should be correct. If for any reason the motor is rotating in the wrong direction, simply reverse two of the three motor wires to change the direction of rotation.
3. The motor has an optional brake setting. The ESC comes with the brake switched off and we recommend that the **P-51** be flown with the brake off. However, the brake could be accidentally switched on if the motor battery is connected to the ESC while the throttle stick is set at full throttle. To switch the brake off, move the throttle stick to full throttle and plug in the motor battery. The motor will beep one time. Move the throttle stick to low throttle or the off position. The motor is ready to run and the brake will be switched off.
4. Battery Selection and Installation. We recommend the 22.2V 3300-4000mAh 25C (**500g/19.7oz**) Li-Po battery. If using another battery, the battery must be at least a 22.2V 3300-4000mAh 25C battery. Your battery should be approximately the same capacity, dimension and weight as the 22.2V 3300-4000mAh 25C Li-Po battery to fit in the fuselage without changing the center of gravity significantly.
5. The specification of the model list as follows:
 - Wing span: 1700mm/66.9in**
 - Length: 1480mm/58.3in**
 - Motor : 5060-KV360**
 - ESC : 85A with integrated 8A SBEC**
 - Battery : 22.2V 3300-4000mAh 25C**
 - Servo : 9g*3 25g*6 17g*1**
 - Approx flying weight: 4080g**
 - Propeller: 10*8 four blades scale propeller**
 - Wing area: 52.1dm²**
 - Wing loading: 78.3 g/dm²**

Final assembly and set-up procedures











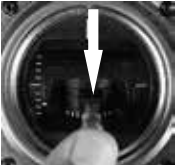

The transmitter and model setup

Before getting started, rebind your receiver with your transmitter if necessary.

CAUTION: To prevent personal injury, DO NOT install the propeller assembly onto the motor shaft while testing the control surfaces .

Tips: Make sure all control sticks on your radio are in the neutral position (rudder, elevator, ailerons) and the throttle in the OFF position. Make sure both ailerons move up and down (travel) the same amount. This model tracks well when the left and right ailerons travel the same amount in response to the control stick.

1. Move the controls on the transmitter to make sure aircraft control surface move correctly. See diagrams below. If controls respond in the opposite direction reverse the direction for operation of flight controls. Refer to your transmitter's instructions for changing direction of transmitter flight controls.

 	<p>Bank Left</p> <p>Bank Right</p>	 	Aileron
 	<p>Climb</p> <p>Descend</p>	 	Elevator
 	<p>Yaw Left</p> <p>Yaw Right</p>	 	Rudder/ Steering

Final assembly and set-up procedures

2. Recheck to align the control surfaces well by trim the control channel.
The ailerons align with the trailing edge of the wing tip.

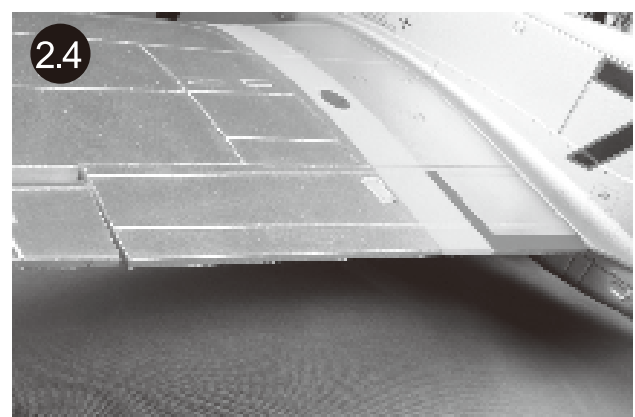
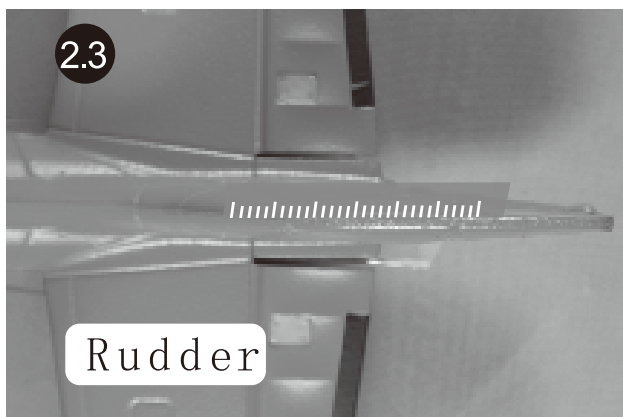
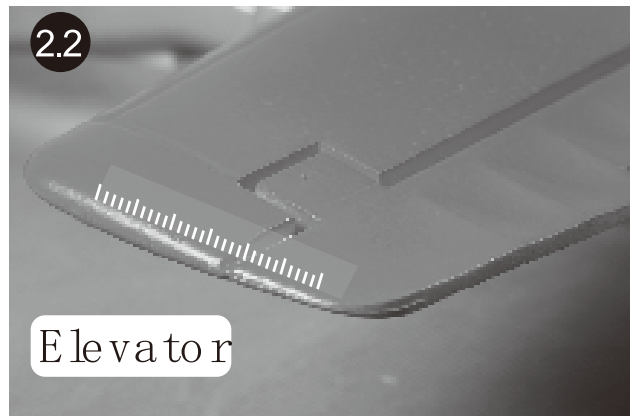
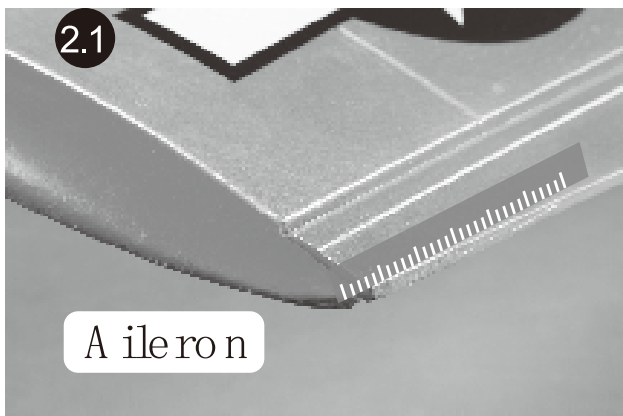

Final assembly and set-up procedures

Check the control throws

1. Adjust ATV/travel adjustment on your transmitter until you obtain the following control surface travel. Do not adjust dual rates until you have correctly adjusted the total travel.

Ailerons: 23mm up and down (both ailerons), measured at the aileron inboard side.

Elevator: 16mm up and down, measured at the counterbalance leading edge.

Rudder: 22mm left and right, measured at the counterbalance leading edge.

Flaps: Full 60mm

2. The dual rates and the Exponential setting for intermediate flyers of **P-51** are based on the ATV set in previous step.

	High Rate	Expo	Low Rate	Expo
Aileron	100% 23mm up/down	30%	69% 11mm up/down	20%
Elevator	100% 16mm up/down	25%	63% 10mm up/down	20%
Rudder	100% 22mm left/right	25%	75% 15mm left/right	15%

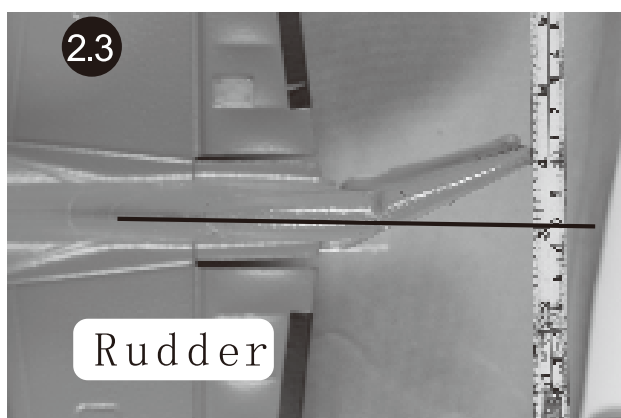
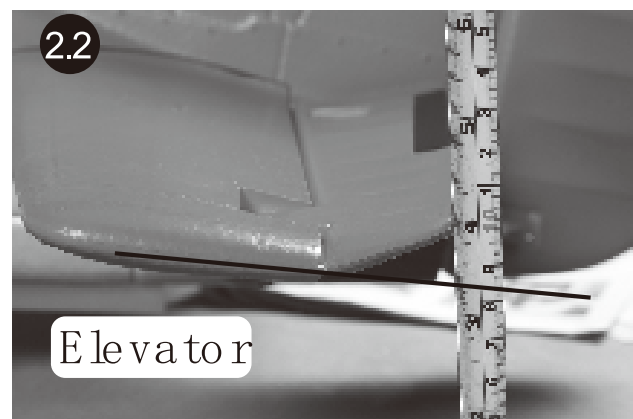

Installing the propeller

- Note:** 1. This control throws were developed by R&D department for the best performance of the P-51. The small mount of elevator throw on low rate is capable of extreme aerobatics.
2. At first flight, fly the model in low rate. The first time you use high rates, be sure to fly at low to medium speeds. High rates, as listed, are only for EXTREME maneuvering. Only switch to high rate when the plane is flying at slow speed. Never fly at high speed at full air speed. This plane is very responsive and pilot can easily lose orientation. Get familiar with the plane first and then try high rate.
3. For take off and landing, low rate in all control surfaces is strongly recommended.

Install the propeller set

Caution: Disconnect the battery from the ESC before installing the propeller. Before testing the propeller, make sure the tail of the plane is firmly on the ground and ensure there are no people or objects in the range of the propeller. Make sure the throttle stick and the trim on the lowest position before plug in the battery.

1. The propeller and spinner set

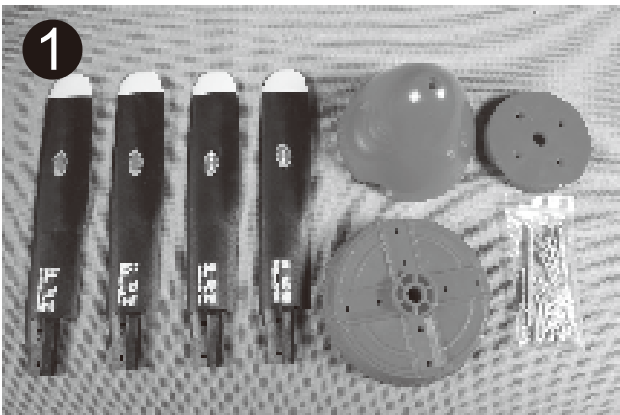

2. Place the self-locking nuts rightly into the outboard hex notch on the bottom of the spinner back plate. Don't install the inboard hex notch self-locking nuts.
- Note: Always use a piece of scrapped board (laminated board, plastic or metal board) hold the nuts into place in the process of blades mounting.

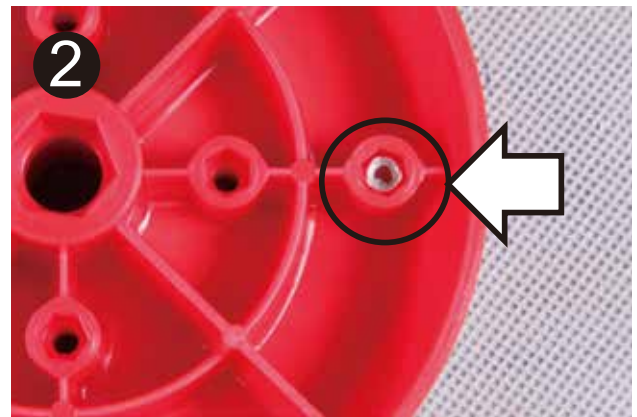

3. Fit the blade in place with the letter side face up, use the shorter screw (25mm) to secure the blade in the blade tip side screw hole. Make sure holding the nut into place when tighten the screw to save time. Note: only secure the inboard propeller hole as picture shows

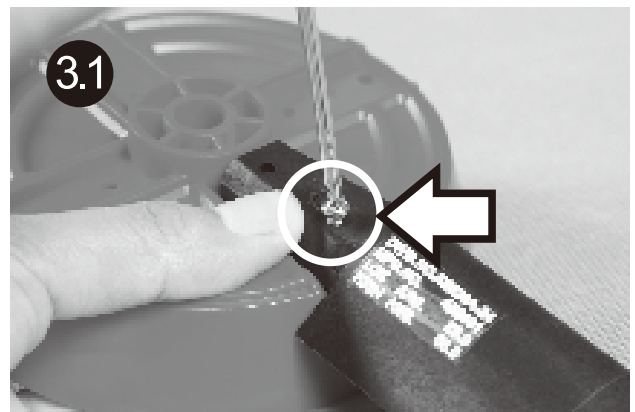

Installing the propeller



4. Place self-locking nuts rightly into the inboard hex notch on bottom of the spinner back plate as picture shows. Cover the cover plate on the propellers. Using the longer screws(27mm) to secure the cover plate with the propeller and spinner plate tight enough as the pictures shows.

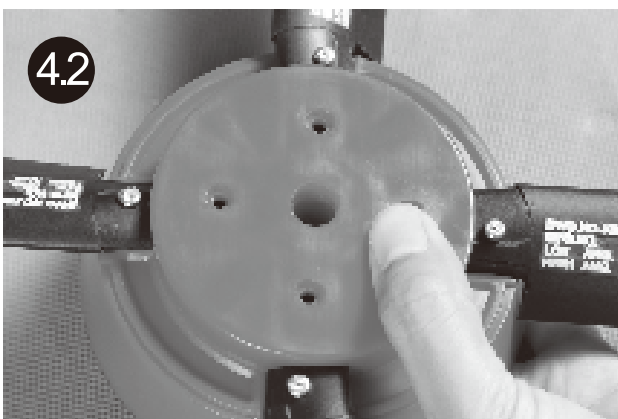
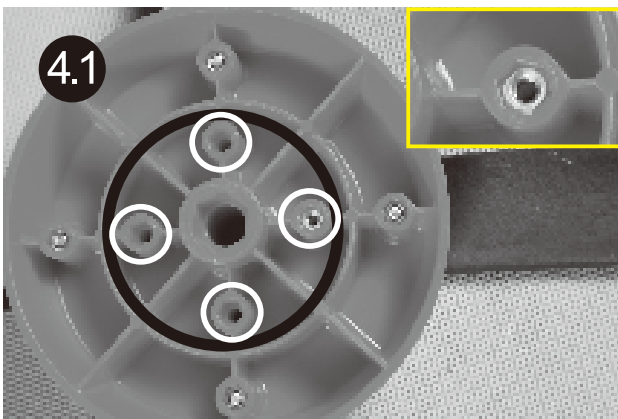

5. After the four screws' tightening complete, make sure there is no gap between this propeller holder plate.

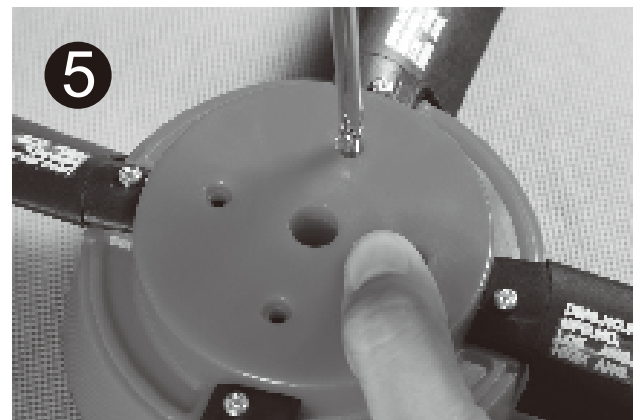

6. Verify the status of the propeller installation completed.

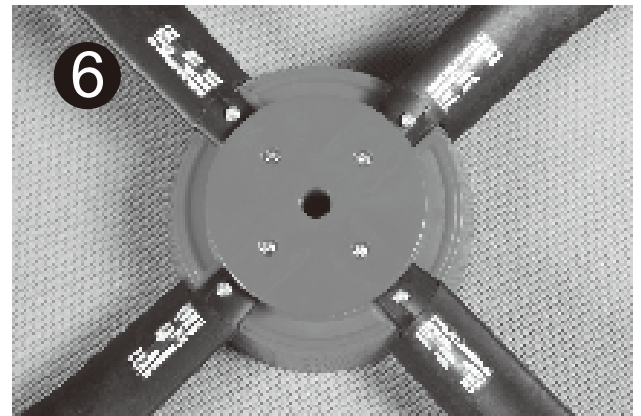

7. Keyed the propeller assembly to the motor shaft, make sure fit the assembly into the hex stage on the shaft, it will help to hold the assembly in fixed position when the engine contact.

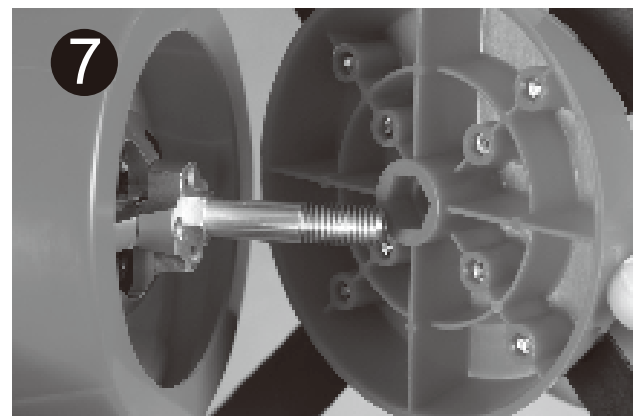

Installing the propeller

8. Secure the propeller by tighten the nut use the wrench, do not over tighten, but make sure it's tight enough.

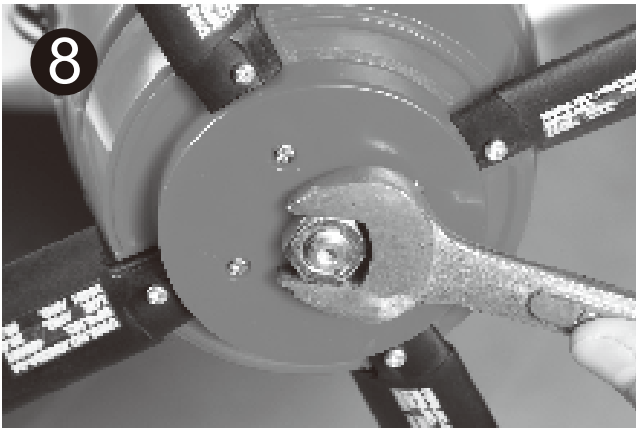

9. Fit the spinner into place.

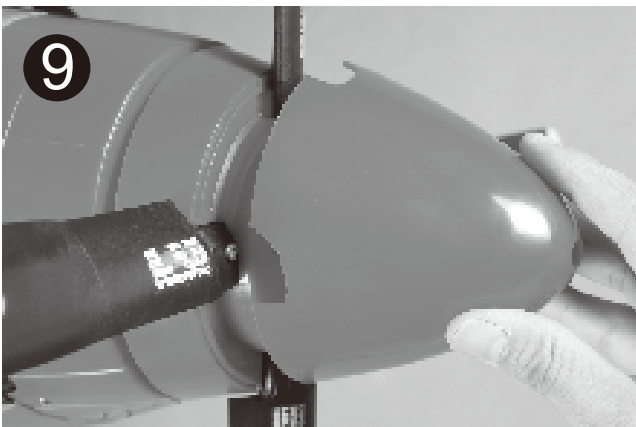

10. Secure the spinner using the provided screws.(PM4*65 1PC)

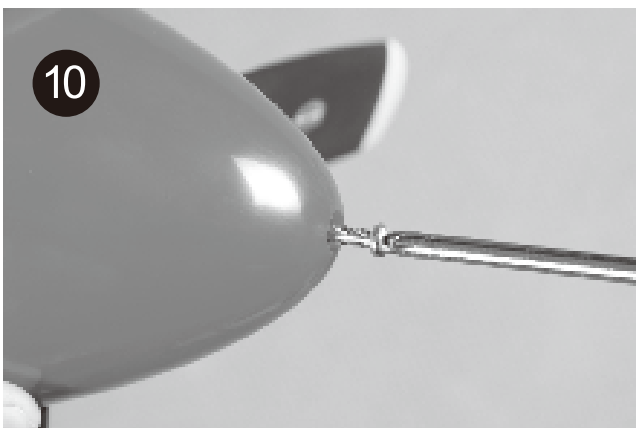

11. Install the antenna by applying appropriate amount of glue in the slot pre-notshed for the antenna using the toothpick.

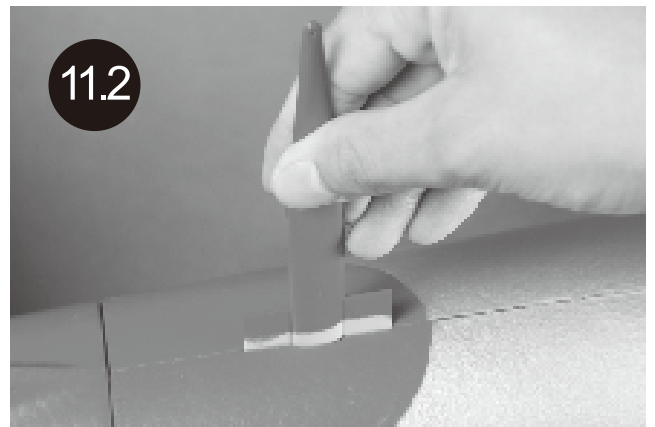
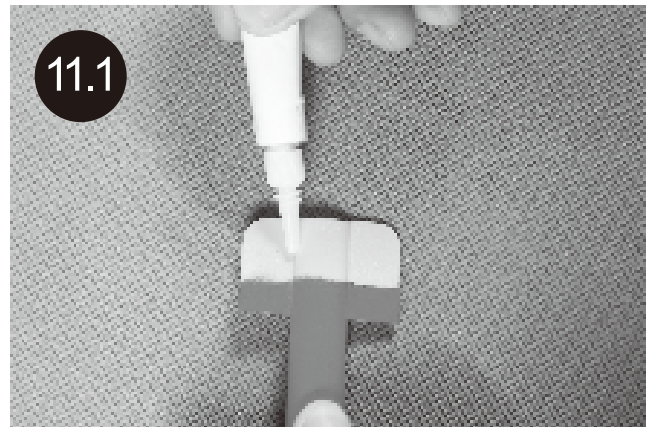

Maintenance mark applying instruction

Note: Please apply the maintenance mark details as the guiding illustrated pictures shows.

①	INSPINSPINSPINSP	17	100 A OR US GAL OR 712oz BEFORE GRADE	18	GROUND HERE
②	MOORING RINGS MOORING RINGS	19	COOLANT DRAIN		
③	JACK JACK JACK JACK HERE HERE HERE HERE	19B	STEP HERE		
④	REMOVE FOR GROUND HEATER DUCT	19A	COOLANT VENT AFTER COOLANT VENT		
⑤	OIL DRAIN	20	OXYGEN FILTER INSTRUCTIONS INSIDE LIFT CAUTION		
⑥	REMOVE FOR GROUND HEATER DUCT		LIFT CAUTION		
⑦	CAMERA ACCESS				
⑧	AMMUNITION 8 GUN ACCESS				

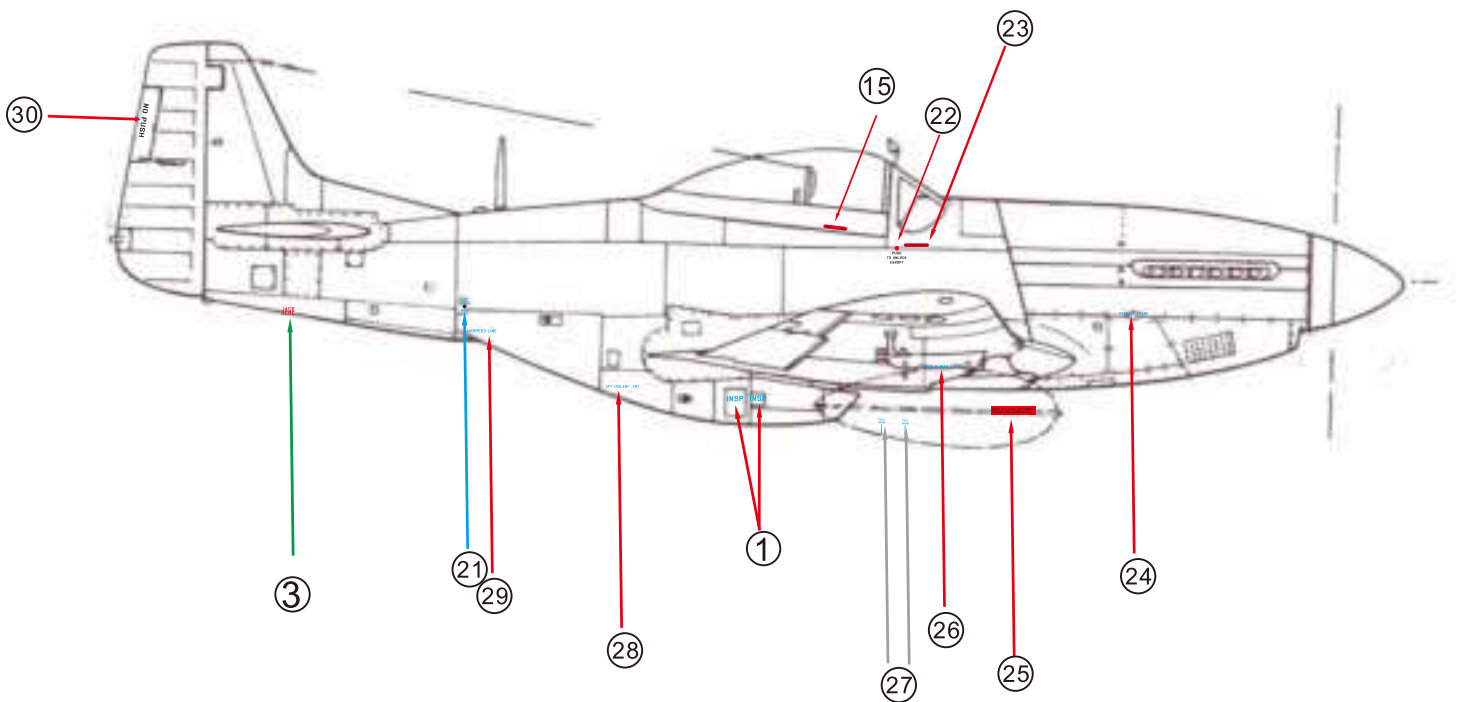
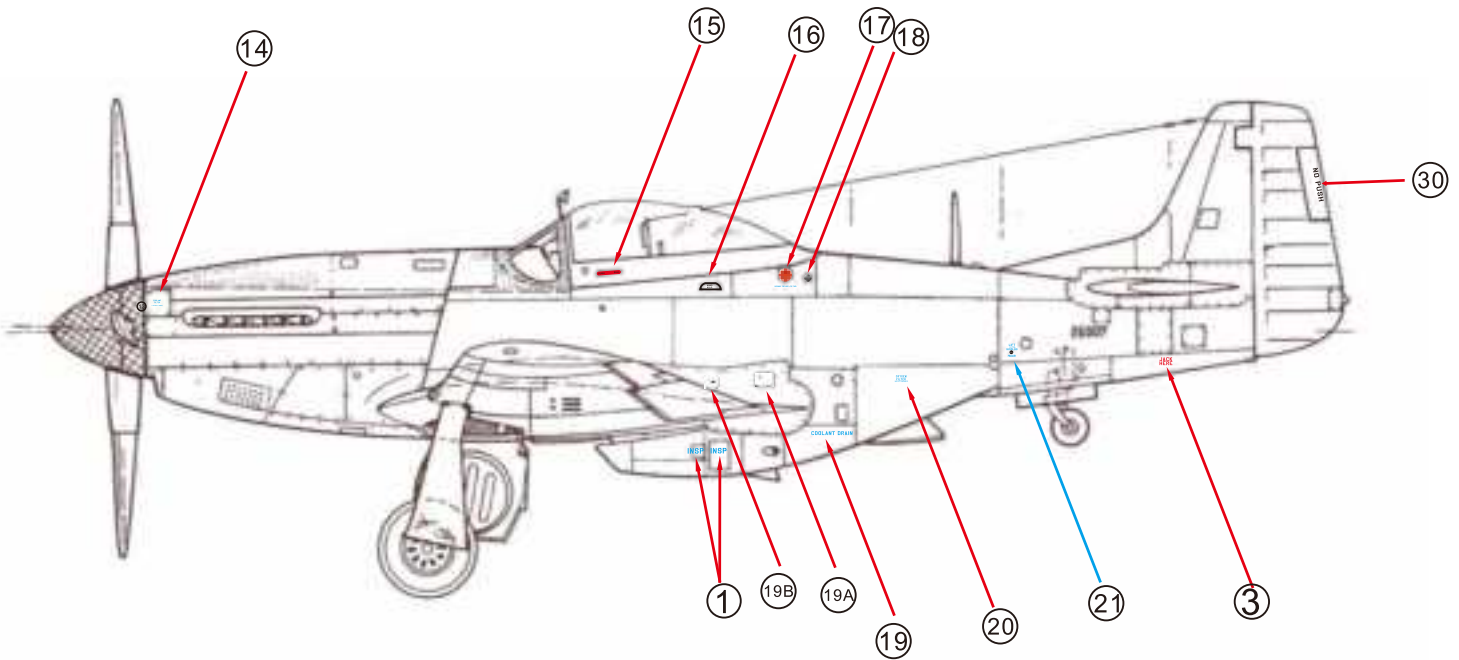

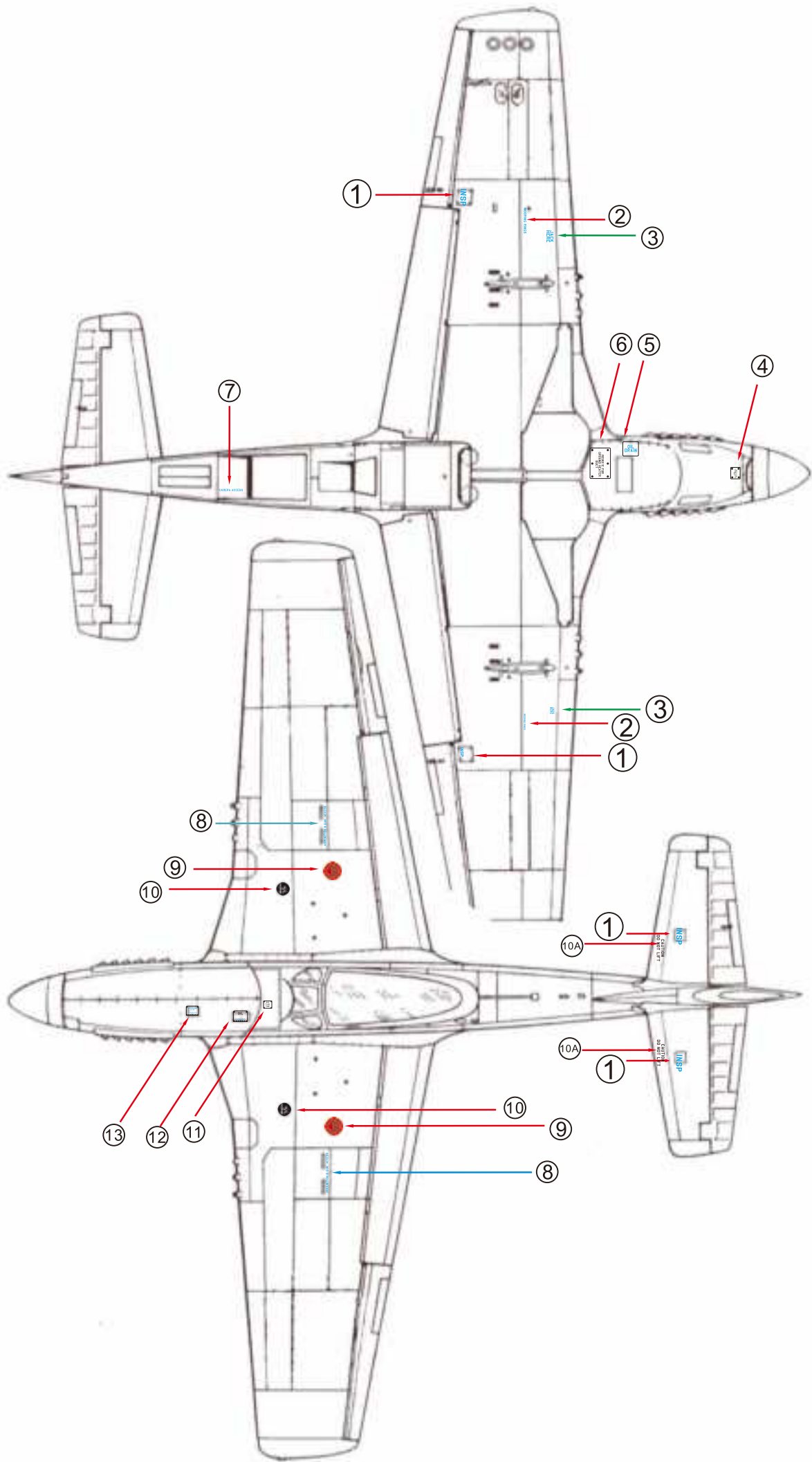

Final assembly and set-up procedures

Check the C.G.(Center of Gravity)

Center of Gravity

When balancing your model, adjust the motor battery as necessary so the model is level or slightly nose down. This is the correct balance point for your model. After the first flights, the **CG** position can be adjusted for your personal preference.

1. The recommended Center of Gravity (**CG**) location for your model is (**120mm/4.72in**) forward from the leading edge of the main wing (as shown) with the battery pack installed. Mark the location of the **CG** on top of the wing.
2. When balancing your model, support the plane at the marks made on the top of the main wing with your fingers or a commercially available balancing stand. This is the correct balance point for your model. Make sure the model is assembled and ready for flight before balancing.
3. Always balance the plane with the retracts down.

Caution: Do not connect the battery to the ESC while balancing the plane.

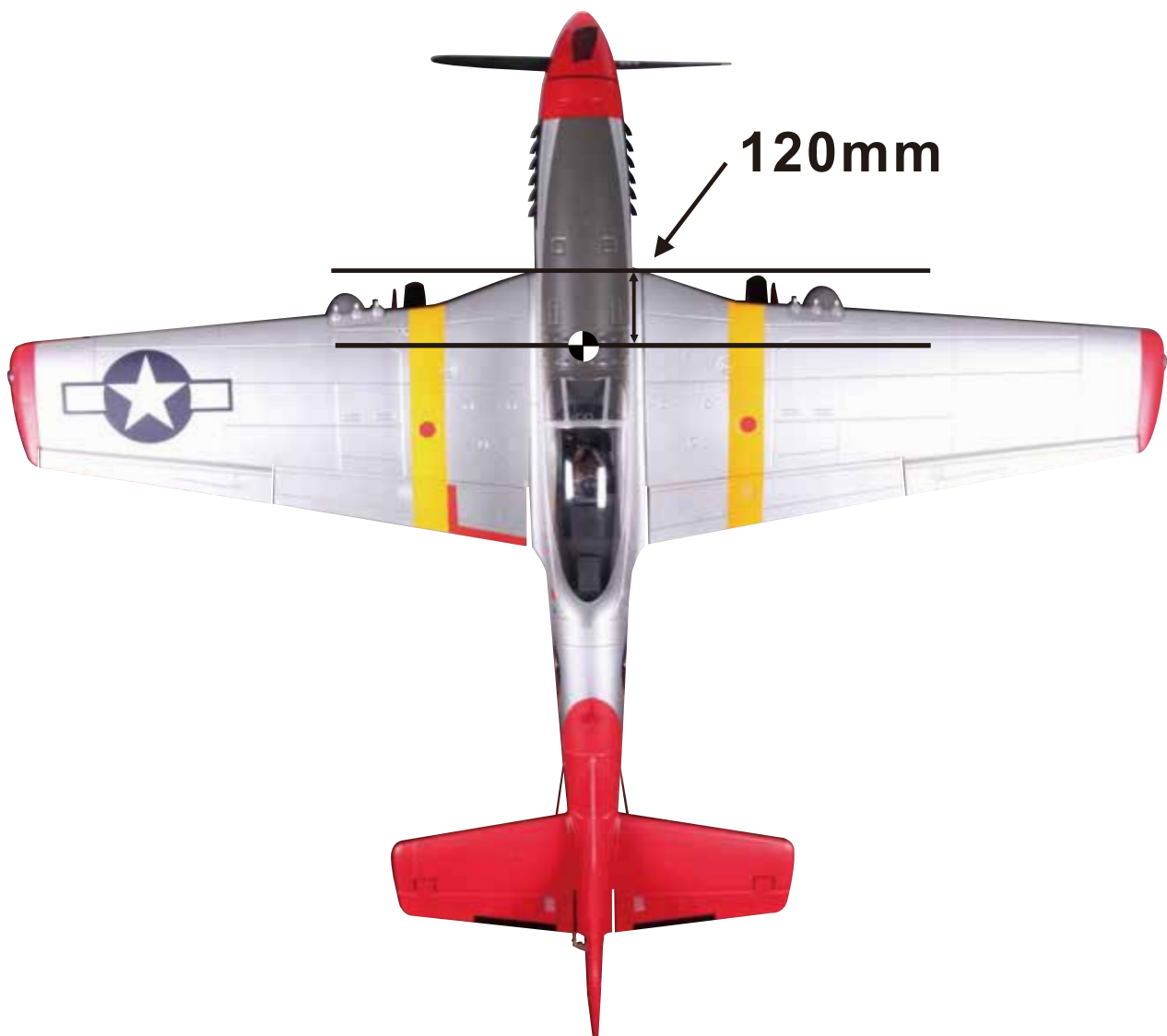

ESC instruction

Wires Connection:

The electronic speed controller can be connected to the motor by soldering directly or with high quality connectors. Always use new connectors, which should be soldered carefully to the cables and insulated with heat shrink tube. The maximum length of the battery pack wires shall be within 6 inches.

- Solder controller to the motor wires.
- Solder appropriate connectors to the battery wires.
- Insulate all solder connectors with heat shrink tubes.
- Plug the "JR" connector into the receiver throttle channel.
- Speed Controller Red and Black wires connects to battery pack Red and Black wires respectively.

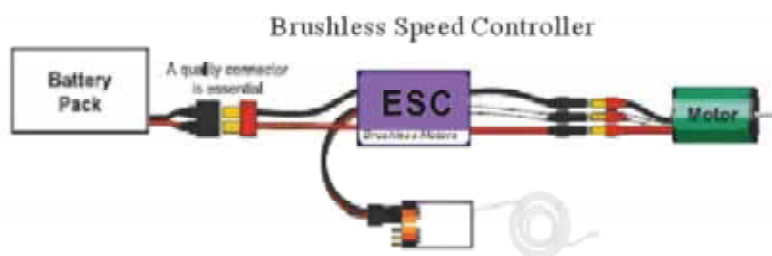

Specification:

Model #	Cont. Current(A)	Burst Current (A) 10s.	Battery cell NiXX/Lipo	Weight (g)	BEC Output	Size (mm) W*L*H	User Program
6A	6A	8A	5-10 NC \ 2-3 Lipo	5	5volts / 2amps	13 x 21 x 4	yes
12A	12A	16A	5-12 NC \ 2-4 Lipo	8	5volts / 1amps	21 x 22 x 4	yes
20A	20A	30A	5-12 NC \ 2-4 Lipo	18	5volts / 3amps	13 x 21 x 4	yes
30A	30A	40A	5-12 NC \ 2-4 Lipo	30	5volts / 3amps	23 x 43 x 6	yes
35A	35A	45A	5-12NC \ 2-4 Lipo	47	5volts / 4amps	28 x 38 x 8	yes
40A	40A	50A	5-12 NC \ 2-4 Lipo	44	5volts / 3amps	28 x 38 x 8	yes
45A	45A	55A	5-12 NC \ 2-4 Lipo	42	5volts / 3amps	31 x 58 x11	yes
50A	50A	70A	5-18NC \ 2-6 Lipo	45	5.5volts / 5amps	31 x 58 x 11	yes
60A	60A	70A	5-12NC \ 2-4Lipo	50	5.5volts / 3amps	36 x 50 x 8	yes
65A	65A	85A	5-18NC \ 2-6Lipo	58	5.5volts / 5amps	30 x 56 x 11	yes
70A	70A	75A	5-12NC \ 2-6 Lipo	56	5.5volts / 5amps	34 x 52 x 14	yes
85A	85A	100A	5-18NC \ 2-6Lipo	63	5.5volts / 5amps	34 x 52 x 14	yes

Features:

- ◆ Extremely low internal resistance
- ◆ Super smooth and accurate throttle linearity
- ◆ Safety thermal over-load protection
- ◆ Auto throttle shut down in signal loss situation
- ◆ Supports high RPM motors
- ◆ Power arming protection (prevents the motor from accidentally running when switched ON)
- ◆ New advanced programming software

Our ESC allows you to program parameters to fit your specific needs:

Our ESC allows you to program parameters to fit your specific needs:

1. User programmable brake setting (we recommend using brake for only folding props applications)
2. User programmable battery type (LiPo or NiCd/NiMh)
3. User programmable low voltage cutoff setting
4. User programmable factory default setting restore
5. User programmable timing settings (to enhance ESC efficiency and smoothness)
6. User programmable soft acceleration start ups (for delicate gearbox and helicopter applications)
7. User programmable governor mode (for helicopter applications)
8. User programmable motor rotation (clockwise\counterclockwise)
9. User programmable switching frequency
10. User programmable low voltage cutoff type (power reduction or immediate shutdown)

Settings:

1. Brake: ON/OFF

* ON-Sets the propeller to the brake position when the throttle stick is at the minimum position (Recommended for folding props).

* OFF-Sets the propeller to freewheel when the throttle stick is at the minimum position.

2. Battery type: LiPo or NiCad/NiMh

* NiCad/NiMh – Sets Low Voltage protection threshold for NiCad/NiMh cells.

* LiPo – Sets Low voltage protection threshold for LiPo cells and automatically detects the number of cells within the pack.

Note: Selecting the NiCad/NiMh option for the battery type, triggers the ESC to automatically set the cutoff threshold to the factory default of 65%. The cutoff threshold can then be subsequently altered through the Low Voltage protection function, if required. The ESC will read the initial voltage of the NiCad/NiMh pack once it is plugged in and the voltage read will then be used as a reference for the cutoff voltage threshold.

3. Low Voltage Protection Threshold (Cutoff Threshold):

Low / Medium / High

1) For Li-xx packs- number of cells are automatically calculated and requires no user input apart from defining the battery type. This ESC provides 3 setting options for the low voltage protection threshold; Low (2.8V)/ Medium (3.0V)/ High (3.2V). For example: the voltage cutoff option for an 11.1V/ 3 cell Li-Po pack would be 8.4V (Low)/ 9.0V (Med)/ 9.6V (High)

2) For Ni-xx packs-low / medium / high cutoff voltages are 50%/65%/65% of the initial voltage of the battery pack. For example: A fully charged 6 cell NiMh pack's voltage is $1.44V \times 6 = 8.64V$, when "LOW" cutoff voltage is set, the cutoff voltage is: $8.64V \times 50\% = 4.32V$ and when "Medium" or "High" is set, the cutoff voltage is now $8.64V \times 65\% = 5.616V$.

4. Restore factory setup defaults:

Restore - Sets the ESC back to factory default settings;

Brake :	Off
Battery type Detect :	LiPo with Automatic Cell
Low voltage cutoff threshold :	Medium (3.0V/65%)
Timing setup :	Automatic
Soft Acceleration Start Up :	Medium
Governor mode :	OFF
Frequency :	16kHz
Low voltage cutoff type :	Reduce power

5. Timing setup: Automatic / Low / High.

- * Automatic – ESC automatically determines the optimum motor timing
- * Low (7-22 deg) – Setting for most 2 pole motors.
- * High (22-30 deg)-setting for motors with 6 or more poles.

In most cases, automatic timing works well for all types of motors. However for high efficiency we recommend the Low timing setting for 2 pole motors (general in-runners) and high timing for 6 poles and above (general outrunners). For higher speed, High timing can be set. Some motors require different timing setups therefore we suggest you follow the manufacturer recommended setup or use the automatic timing setting if you are unsure.

Note: Run your motor on the ground first after making any changes to your motor timing!

6. Soft Acceleration Start ups: Very Soft / Soft Acceleration/ Start Acceleration

- * Very Soft – Provides initial slow 1.5 sec ramp-up from start to full rpm intended to protect delicate gears from stripping under instant load. This setting is recommended for either fixed wing models equipped with gearboxes and / or helicopters.
- * Soft Acceleration- Provides initial slow 1 sec ramp-up from start to full rpm. This setting is recommended for either fixed wing models equipped with gearboxes and or helicopters.
- * Start Acceleration – Provides quick acceleration start ups with a linear throttle response. This is recommended for fixed wing models fitted with direct drive setups.

7. Active RPM Control (Heli Governor Mode)

- * RPM control off

* **First range:** There will be a 5-second delay from start to full rpm, but if the throttle is cutoff after starting, then the next start will be as normal start.

* **Second range:** There will be a 15-second delay from start to full rpm, but if the throttle is cutoff after starting, then the next start will be as normal start.

Note: Once the Governor Mode is enabled, the ESC's Brake and Low Voltage Cutoff Type settings will automatically be reset to No Brake and Reduce Power respectively regardless of what settings they were previously set.

8. Motor Rotation: Reverse

In most cases motor rotation is usually reversed by swapping two motor wires. However, in cases where the motor cables have been directly soldered to the ESC cables, motor rotation can be reversed by changing the value of setting on the ESC.

9. Switching Frequency: 8 kHz/16kHz

- * 8 kHz – Sets ESC switching frequency for 2 pole motors, e.g. in-runners.
- * 16 kHz – Sets ESC switching frequency for motors with more than 2 poles, e.g. out-runners.

Although 16 kHz is more efficient without Thrust motors, the setup default is 8 kHz due to the higher RF noises caused at 16 kHz.

10. Low Voltage Cutoff Type: Reduce Power / Hard cutoff

- * Reduce Power – ESC reduces motor power when the pre-set (recommended).
- * Hard Cutoff – ESC instantly cuts motor power when the pre-set Low Voltage Protection Threshold value is reached.

Programming Mode Audible Tones

Programming Mode Audible Tones	ESC Functions
0 Throttle Calibration (within the first 4 Sec) ● ● ● ●	

1	Brake * * * *	Brake On /Off
2	Battery type ~ ~ ~ ~ ~ ~ ~ ~	NiCad LiPo
3	Low Voltage Cutoff Threshold *	Low 2.8V/50% Medium 3.0V/60% High 3.2V/65%
4	Restore Factory Setup Defaults _ _ _ _ _	Restore
5	Timing Setup _ _ _ _ _ _ _ _ _ _ _ _ _ _ _	Automatic (7-30°) Low (7-22°) High (22-30°)
6	Soft Acceleration Start Ups V	Very Soft Soft Acceleration Start Acceleration
7	Governor Mode * * * * * ** ** ** ** *** ** ** *** **	Rpm off Heli first range Heli second range
8	Motor Rotation W W W W	Positive/ Reverse
9	Switching Frequency // // // // \\ \\ \\ \\	8kHz 16kHz
10	Low Voltage Cutoff Type X X X X X X X X	Reduce Power Hard Cut Off

Using Your New ESC

Improper polarity or short circuit will damage the ESC therefore it is your responsibility to double check all plugs for proper polarity and firm fit BEFORE connecting the battery pack.

Alert Tones

The ESC is equipped with audible alert tones to indicate abnormal conditions at power up.

If the ESC can't enter into working mode after powering up, indicates that you have not setup throttle calibration.

1. Continuous beeping tone (****) – Indicates that the rattle stick is not in the minimum position.
2. Single beeping tone followed by a one second pause (* * * *) – Indicates that the battery pack voltage is not within the acceptable range. (The ESC automatically checks and verifies the battery voltage once the battery is connected).
3. A single beeping tone followed by a short pause (* * * *) – Indicates that the ESC is unable to detect the normal throttle signal from the receiver.

Built-in Intelligent ESC Safety Functions

1. Over-heat protection: When the temperature of ESC exceeds 110 deg C, the ESC will reduce the output power to allow it to cool.
2. Lost Throttle signal protection: The ESC will automatically reduce output power to the motor when it detects a lost

of throttle signal for 2 second, a subsequent loss of throttle signal beyond 2 seconds, will cause the ESC automatically to cut power to the motor.

Powering up the ESC for the first time and setting the Automatic Throttle Calibration

The ZTW ESC features Automatic Throttle Calibration to attain the smoothest throttle response and resolution throughout the entire throttle range of your transmitter. This step is done once to allow the ESC to “learn and memorize” your Transmitter’s throttle output signals and only repeated if you change your transmitter.

1. Switch your Transmitter ON and set the throttle stick to its maximum position.
2. Connect the battery pack to the ESC. **Wait for about 2 seconds, the motor will beep for twice, then put the throttle in the minimum position, the motor will also beep, which indicates that your ESC has got the signal range of the throttle from your transmitter.**

The throttle is now calibrated and your ESC is ready for operation.

Normal ESC start up procedure:

1. Switch your Transmitter ON and set the throttle to its minimum position.
2. Connect the battery pack to the ESC.
3. When the ESC is first powered up, it emits two sets of audible tones in succession indicating the status of its programming state.
 - * The first set of tones denotes the number of cells in the LiPo pack connected to the ESC. (Three beeps (***) indicates a 3 cell LiPo pack while 4 beeps (****) indicates a 4 cell LiPo pack).
 - * The second set denoting Brake status. One beep (*) for Brake “ON” and two beeps (**) for Brake “OFF” .
 - * The ESC is now ready for use.

Entering the Programming Mode:

1. Switch your Transmitter ON and set the throttle to its maximum position.
2. Connect the battery pack to the ESC.
3. Wait until you hear two short beeps (_ **) confirming that the ESC has now entered the programming mode.
4. If within 5 seconds, the throttle stick is lowered to its minimum position, an audible tone is emitted confirming that the **throttle calibration** setting has changed. If the throttle stick is left in the maximum position beyond 5 seconds, the ESC will begin the sequence from one function and its associated setting options to another. (Please refer to the table below to cross reference the functions with the audible tones).
5. When the desired tone for the function and setting option is reached, move the throttle stick down to its minimum position. ESC will emit two beeps (**) confirming the new setting has been stored.
6. The ESC only allows the setting of one function at a time. Therefore should you require making changes to other function disconnect the battery pack and wait 5 seconds to reconnect the battery and repeat the above steps.

General Safety Precautions

Do not install the propeller (fixed wing) or drive pinion (helicopter) on the motor when you test the ESC and motor for the first time to verify the correct settings on your radio. Only install your propeller or pinion after you have confirmed that the settings on your radio is correct.

- Never use ruptured or punctured battery cells.
- Never use battery packs that are known to overheat.
- Never short circuit battery or motor terminals.
- Always use proper insulation material for cable insulation.
- Always use proper cable connectors.
- Do not exceed the number of cells or servos specified by the ESC.

Wrong battery polarity will damage the ESC and void the warranty.

- Install the ESC in a suitable location with adequate ventilation for cooling. This ESC has a built-in over heat cutoff protection feature that will immediately cut power to the motor once the ESC temperature exceeds the 230 Deg F/ 110 Deg C high temperature limit.
- Use only batteries that are supported by the ESC and ensure the correct polarity before connecting.
- Switch your Transmitter ON and ensure the throttle stick is in the minimum position before connecting the battery

pack.

- Never switch your transmitter **OFF** while the battery is connected to your ESC.
- Only connect your battery pack just before flying and do not leave your battery pack connected after flying.
- Handle your model with extreme care once the battery pack is connected and keep away from the propeller at all times. Never stand in-line or directly in front of any rotating parts.
- Do not immerse the ESC underwater while powered up.
- Do fly at a designated flying site and abide by the rules and guidelines set by your flying club.

Troubleshooting:

Issue	Possible Reason	Action
Motor doesn't work, but there are audible tones of automatically detection of the number of cells after powering up ESC.	The ESC throttle calibration has not set up.	Set up the ESC throttle calibration.
Motor doesn't work and no audible tone emitted after connecting the battery. Servos are not working either.	Poor/loose Connection between battery Pack and ESC.	Clean connector terminals or replace connector.
	No power	Replace with a freshly charged battery pack
	Poor soldered connections (dry joints)	Re-solder the cable connections
	Wrong battery cable polarity	Check and verify cable polarity
	ESC throttle cable connected to receiver in the reverse polarity	Check the ESC cable connected to the ESC to ensure the connectors are in the correct polarity.
	Faulty ESC	Replace ESC
Motor doesn't work and no audible tone emitted after connecting the battery BUT servos are working.	Poor / loose connection between ESC and motor	Clean connector terminals or replace connectors
Motor doesn't work after powering up the ESC. An alert tone with two beeping tones followed by a short pause (** ** ** *) is emitted.	Burnt motor coils	Replace motor
	Poor soldered connections(dry joints) The battery pack voltage is not within the acceptable range.	Re-solder the cable connections Replace with a freshly charged battery pack Check battery pack voltage
Motor doesn't work after powering up the ESC. An alert tone with a single beeping tone followed by a short pause (* * * *) is emitted.	The ESC is unable to detect the normal throttle signal from the receiver	Check and verify that the ESC cable is connected to the <u>Throttle</u> channel on the receiver. Check the transmitter and receiver to verify that there is throttle signal output. (Connect a spare servo to verify throttle channel operation)
Motor doesn't work after powering up the ESC .An alert tone with continuous beeping tones (****) is emitted.	The throttle stick is not in the <u>minimum</u> position at power up.	Move the throttle stick to the minimum position.
Motor doesn't work after powering up the ESC. ESC emits two long audible tones followed by two short beeps(__ **)	Reversed throttle channel caused the ESC to enter the programming mode.	Enter the servo reverse menu on your transmitter and reverse the throttle channel. Note: For Futaba radios set the throttle channel to Reverse.

Issue	Possible Reason	Action
Motor runs in reverse rotation Motor stops running in flight.	Wrong cables polarity between the ESC and the motor.	Swap any two of the three cable connections between the ESC and the Motor or __ access the Motor Rotation function via the ESC programming mode and change the pre-set parameters.
	Lost throttle signal	Check proper operation of the radio equipment. Check the placement of the ESC and the Receiver and check the route of the receiver' s aerial and ESC cables to ensure there is adequate separation to prevent RF interference. Install a ferrite ring on the ESC' s throttle cable.
	Battery Pack voltage has reached the Low Voltage Protection threshold.	Land the model immediately and replace the battery pack.
	Possible bad cable connection	Check and verify the integrity of the cable connections
Motor restarts abnormally ESC Overheats	Possible RF Interference at the flying field.	The normal operation of the ESC may be susceptible to surrounding RF interference. Restart the ESC to resume normal operation on the ground to verify recurrence. If the problem persists, test the operation of the ESC at a different flying field.
	Inadequate Ventilation	Relocate the ESC to allow better ventilation
	Servos drawing too much current and over loading the ESC.	Use servos that are adequately sized for the ESC. The maximum BEC current drawn should be within the BEC limits.
	Over sized motor or prop	Prop down or resize the motor



MADE IN CHINA