

TO PLAY WITH TRADITIONAL TEE:

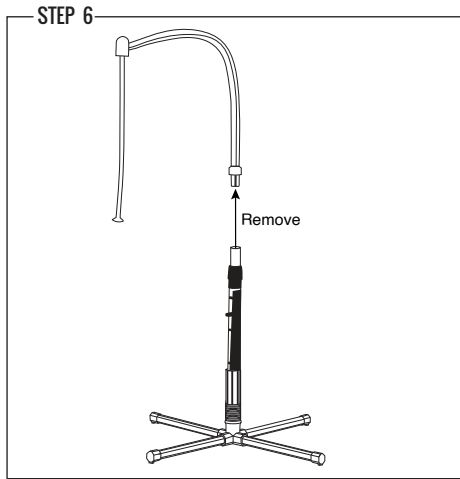

NOTE

Simply remove the **White Arm (E) / Blue Hanging Tee (F)** (these will be locked together) from the **Adjustable Tee Tubing (C)**.

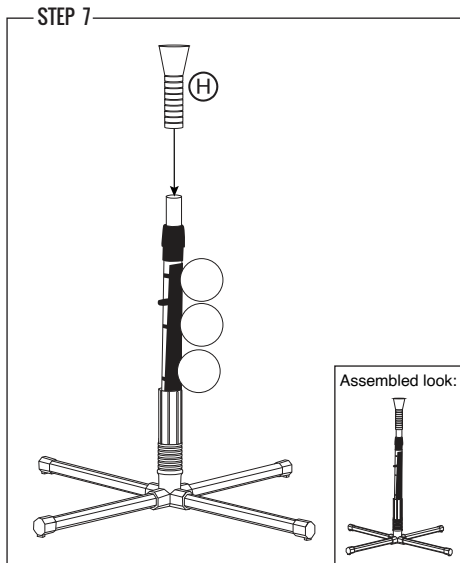

PARTS

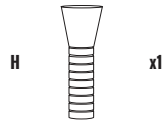

NOTE

Take the **Traditional Tee Topper (H)** and assemble to the top of the **Adjustable Tee Tubing (C)**.

YOU ARE NOW READY TO PLAY WITH YOUR TRADITIONAL TEE!

Made In China
Franklin Sports Inc.
Stoughton, MA 02072



Franklin[®]

AGES 3+

USA SOFTBALL™ 2-IN-1 GROW-WITH-ME™

BATTING TEE

ITEM NUMBER: **64219X**



NOTE: PRINT FRONT TO BACK



CUSTOMER SERVICE COMMITMENT

Thank you for purchasing this Franklin® product! In the event that the product you've purchased has missing or damaged parts, please contact us at:

parts@franklinsports.com

or

Visit our website at: franklinsports.com/instructions

If possible, please include product part number and parts description so we can best assist you.







WE'RE HERE FOR YOU!

PLEASE DO NOT RETURN THIS PRODUCT TO THE STORE IT WAS PURCHASED FROM.

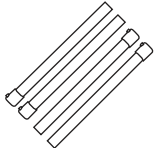
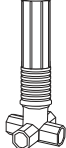
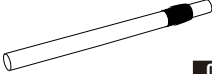
WE ARE COMMITTED TO FULFILLING ALL REPLACEMENT PART NEEDS IMMEDIATELY.

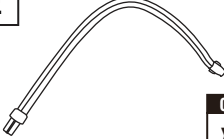
Thank you for your continued support, and welcome to the #FranklinFamily!

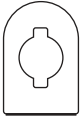
PARTS LIST

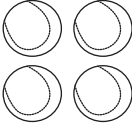
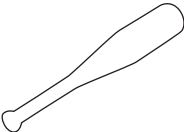
<p>A</p>  <p>QTY x4</p> <p>Weighted Legs Rep. Part: 64219-R1</p>	<p>B</p>  <p>QTY x1</p> <p>Tee Base Rep. Part: 64219-R2</p>	<p>C</p>  <p>QTY x1</p> <p>Adjustable Tee Tubing Rep. Part: 64219-R3</p>
<p>D</p>  <p>QTY x1</p> <p>Self-Stick Sleeve Rep. Part: 64219-R4</p>	<p>E</p>  <p>QTY x1</p> <p>White Arm Rep. Part: 64219-R5</p>	<p>F</p>  <p>QTY x1</p> <p>Blue Hanging Tee Rep. Part: 64219-R6</p>
<p>G</p>  <p>QTY x1</p> <p>Blue Cap Rep. Part: 64219-R7</p>	<p>H</p>  <p>QTY x1</p> <p>Traditional Tee Topper Rep. Part: 64219-R8</p>	<p>I</p>  <p>QTY x4</p> <p>Softballs Rep. Part: 64219-R9</p>
<p>J</p>  <p>QTY x1</p> <p>Bat Rep. Part: N/A</p>		

ASSEMBLY INSTRUCTIONS

GENERAL NOTE

- Remove all components from packaging.
- Sort all components using the parts list and confirm that all parts are included.

STEP 1

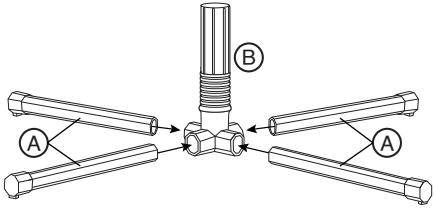

PARTS

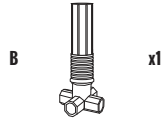
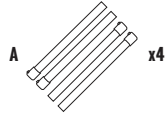

NOTE

Insert **Weighted Legs (A)** into **Tee Base (B)** as shown.

STEP 2

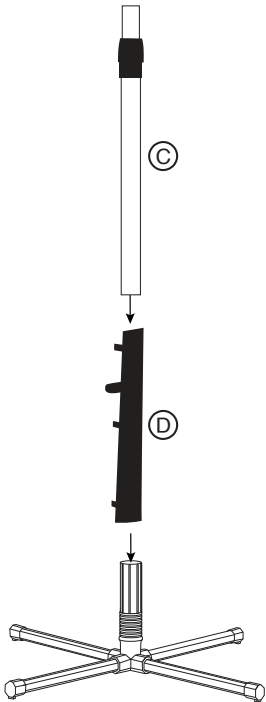

PARTS

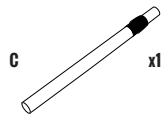

NOTE

Slide the **Adjustable Tee Tubing (C)** through the **Self-Stick Sleeve (D)**. Once this is done, attach the **Adjustable Tee Tubing (C)** to the base as shown.

STEP 3

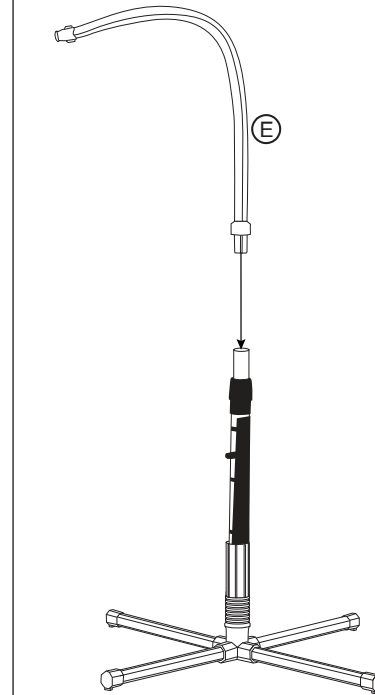

PARTS

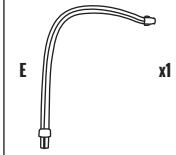

NOTE

Attach the **White Arm (E)** to the tee as shown.

STEP 4A

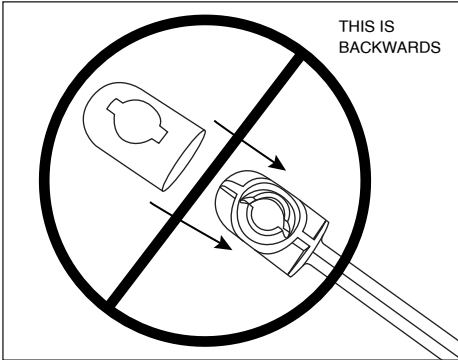
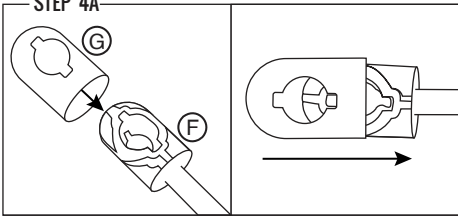

PARTS

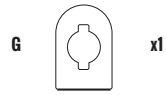
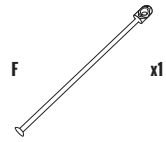
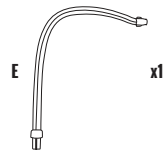

NOTE

Turn the **Blue Hanging Tee (F)** to its front, and then slide the **Blue Cap (G)** over as shown.

Caution: Make sure this piece is assembled correctly. Failure to assemble correctly will result in a blue piece that is not properly locked into place on the **White Arm (E)**. If your blue piece seems like it isn't locking into place securely, then this step has been assembled incorrectly. Take a look at the images to the left to understand which side is the front and which side is the back.

STEP 4B

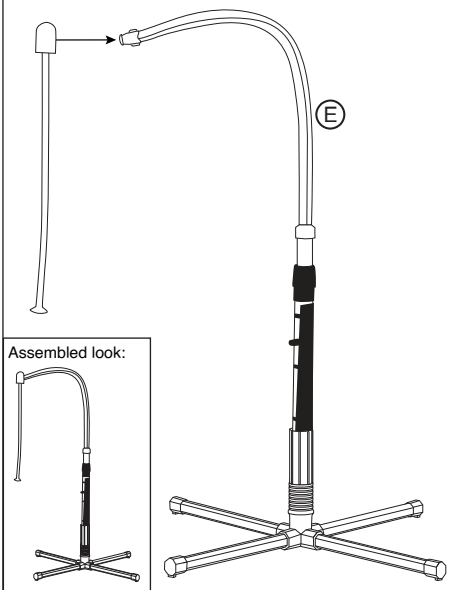

STEP 5

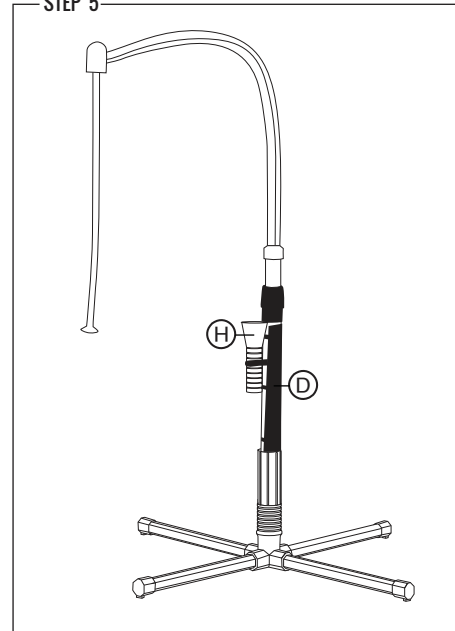

PARTS



NOTE

Your **Traditional Tee Topper (H)** can fasten to the back of the **Self-Stick Sleeve (D)** when playing with this Hanging Tee version so that you don't have to worry about losing pieces!

YOU ARE NOW READY TO PLAY WITH YOUR HANGING TEE!

Flip for more ways to play!

