

STEP 3

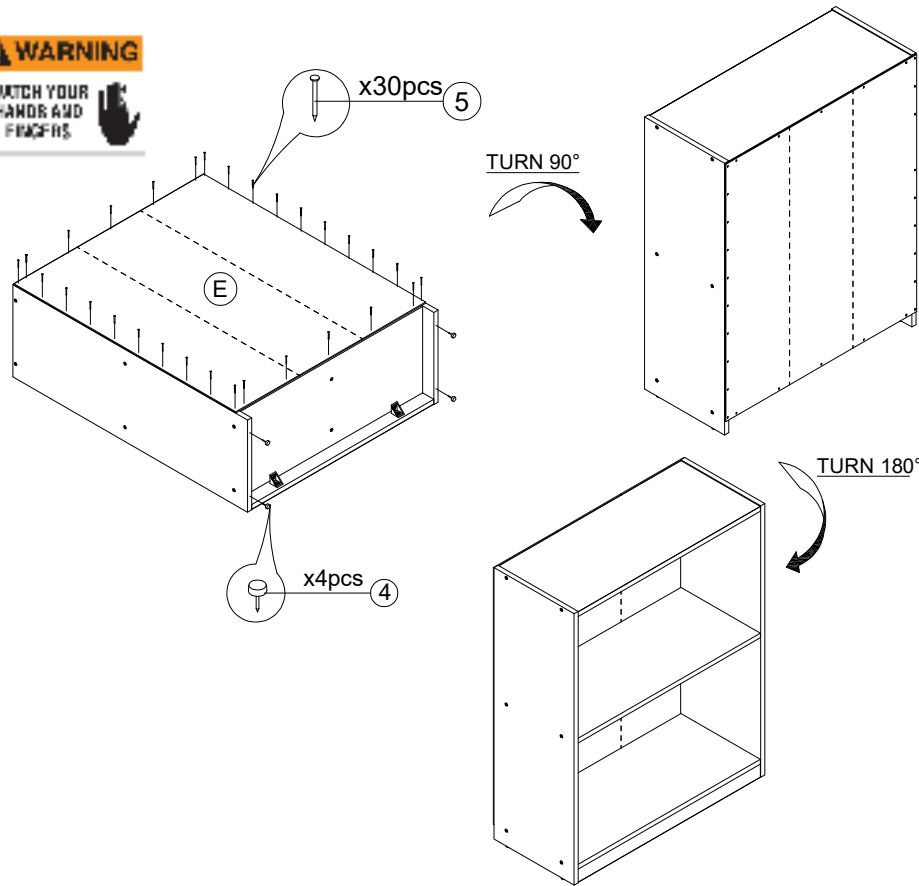

Recommended Maximum Weight

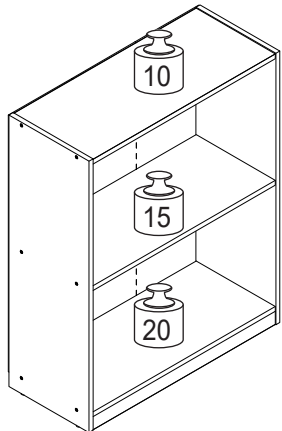

*Unit in Pound(lbs.)

WARNING:

- >This unit has been designed to support the maximum loads shown. Exceeding these load limits could cause sagging, instability, product collapse, and/or serious injury.
- >DO NOT allow children to climb on unit.
- > Put heavier items on lower shelves.

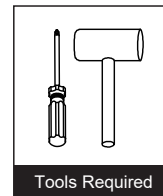
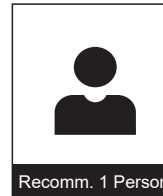
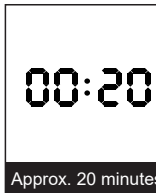

Assembly Instruction

Furinno 2-Tier Open Shelf Bookcase

MODEL : 22131

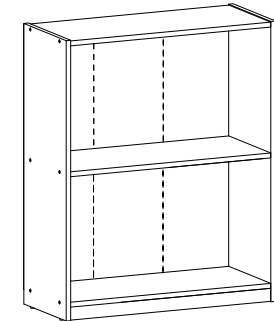





Customer Support

NEED HELP? For replacement requests or product inquiries, please contact our Customer Service Team by emailing us at support@furinno.com. Thank you for selecting Furinno!

www.furinno.com



HARDWARE & PARTS LIST

NO	HARDWARE LIST	QTY
1	POZIHEAD SCREW 	12pcs
2	L BRACKET 	2pcs
3	PWA C/B SCREW 	4pcs
4	NAIL LEG 	4pcs
5	POWER PIN 	30pcs

NO	PART LIST	QTY
A	L/R SIDE PANEL	2pcs
B	TOP & SHELF PANEL	2pcs
C	BOTTOM PANEL	1pc
D	SKIRT PANEL	1pc
E	BACK PANEL	1pc

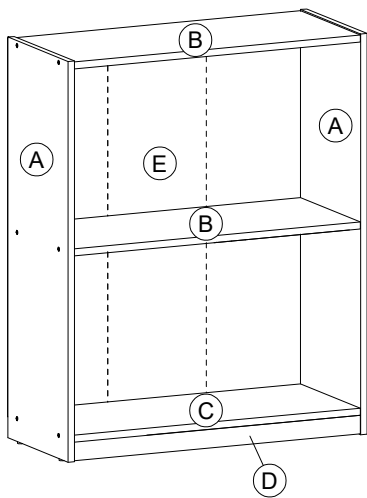

USEFUL HINTS BEFORE YOU START:

1. Read each step carefully before starting.
2. It is important that each step is performed in correct order to avoid difficulties.
3. Identify, sort and count the parts before assembly.
4. Assemble your furniture on packaging cardboard to prevent scratch or damage.
5. Clean the product with mild cleanser using soft damped cloth. Do not use harsh or abrasive cleanser.
6. Using incompatible hardware might cause damage to product.

ASSEMBLY INSTRUCTIONS

BEFORE YOU BEGIN, PLEASE READ ASSEMBLY INSTRUCTION CAREFULLY, FOLLOW THEM STEP BY STEP.

STEP 1

Step 1.1

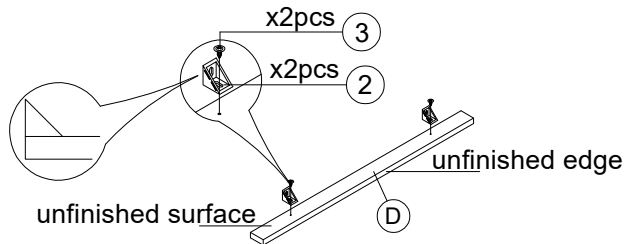

Step 1.2

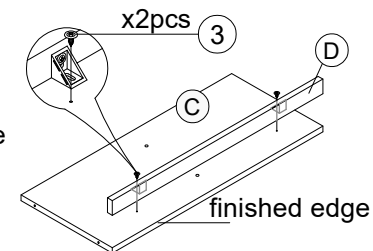

STEP 2

Step 2.1

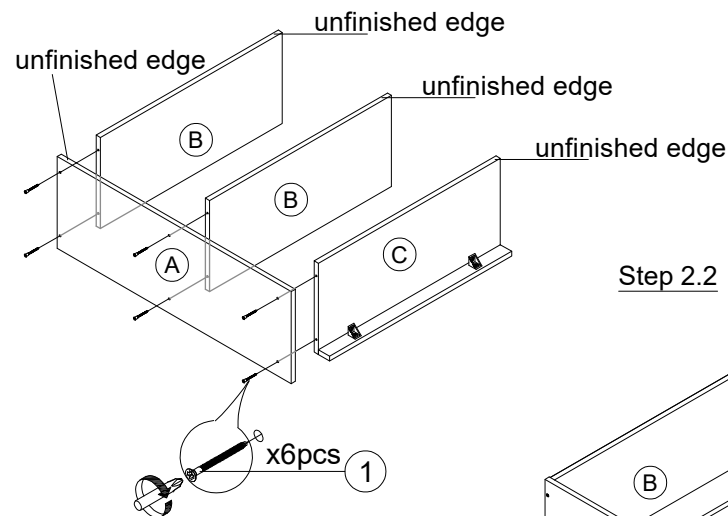

Step 2.2

