

**How to connect radio cables :**

1. Cable without canbus box

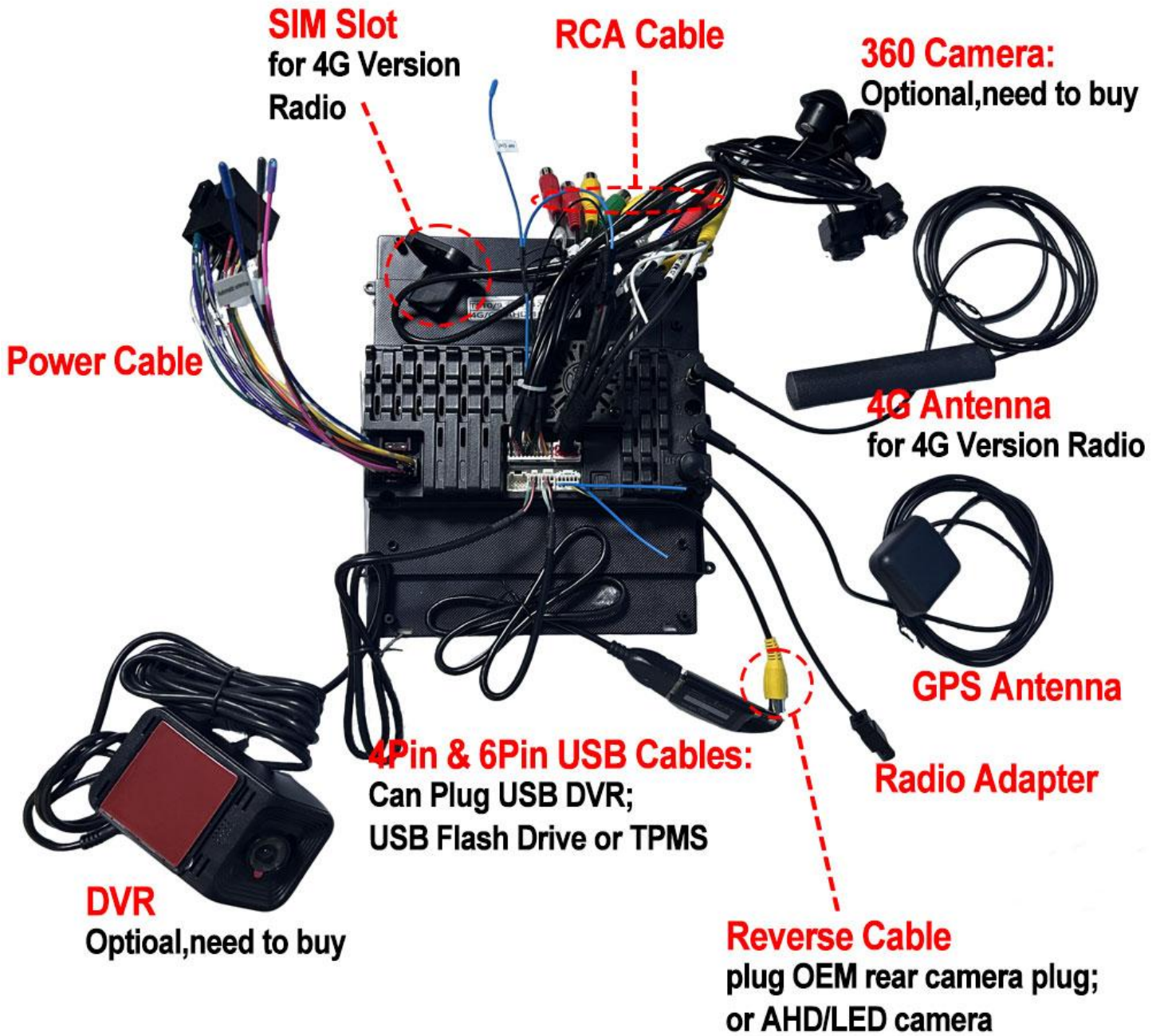

2. Cable with canbus box

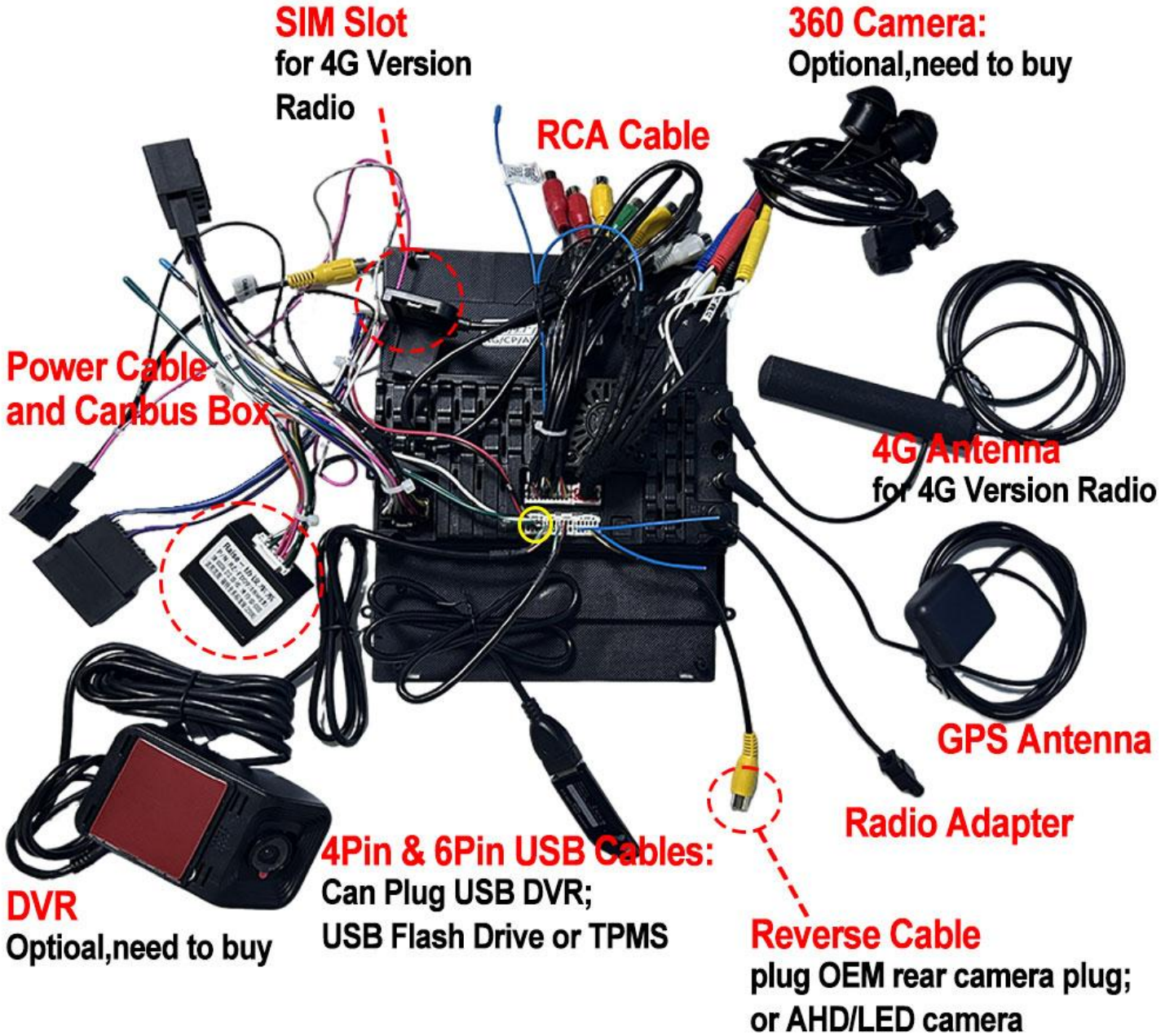

# Pin map by G port

**P1 ( port )**  
**(Side to radio)**

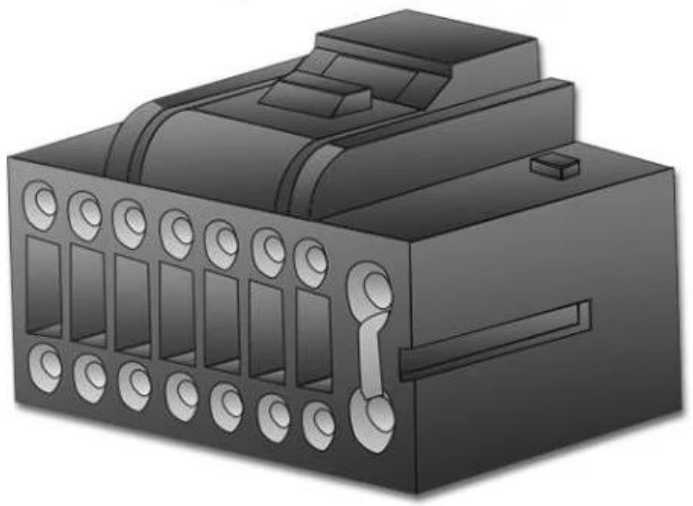

**G ( port )**  
**(Side to car)**

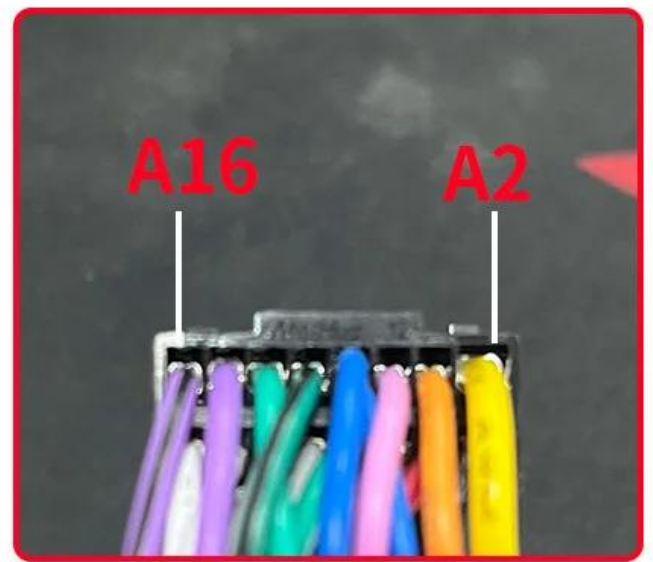
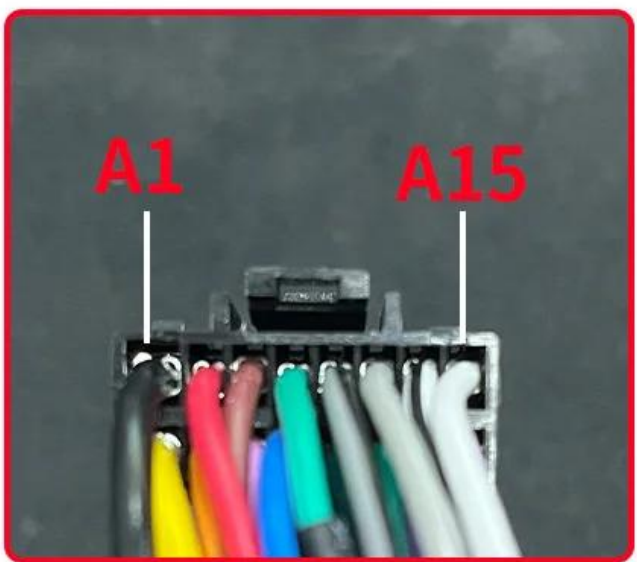
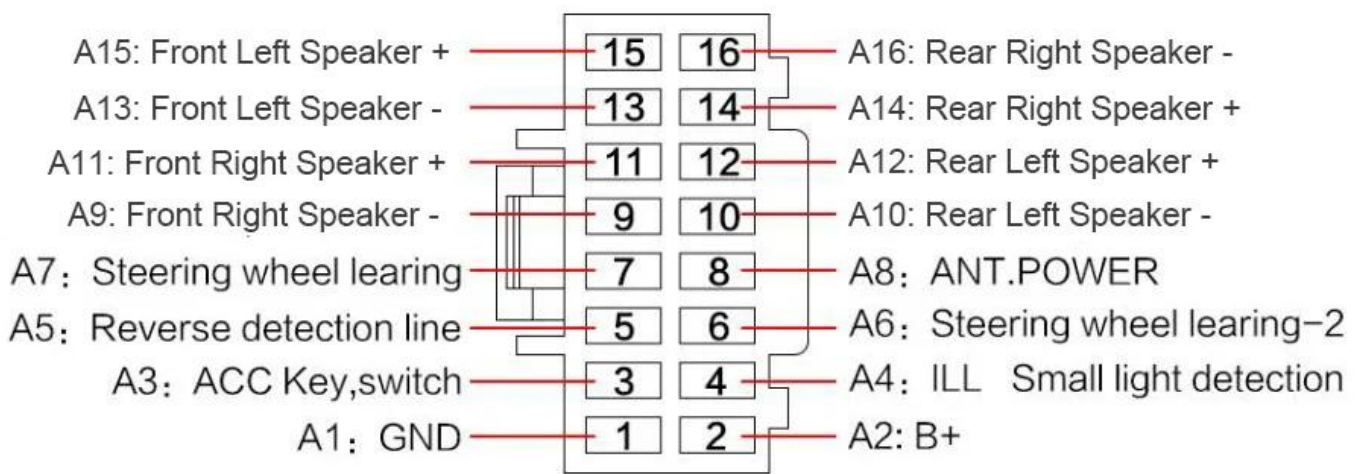
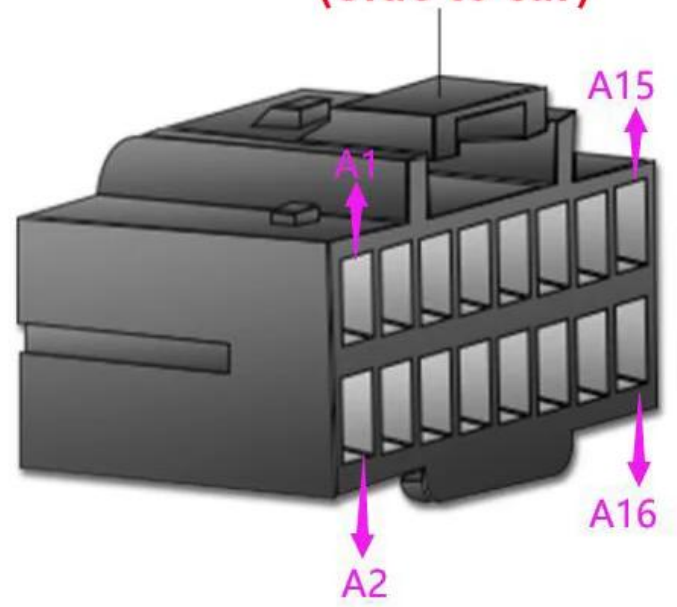

**How to Connect AHD Rear Camera:**

1. Connect Original car rear camera:

(For power cable can support original car rear camera)

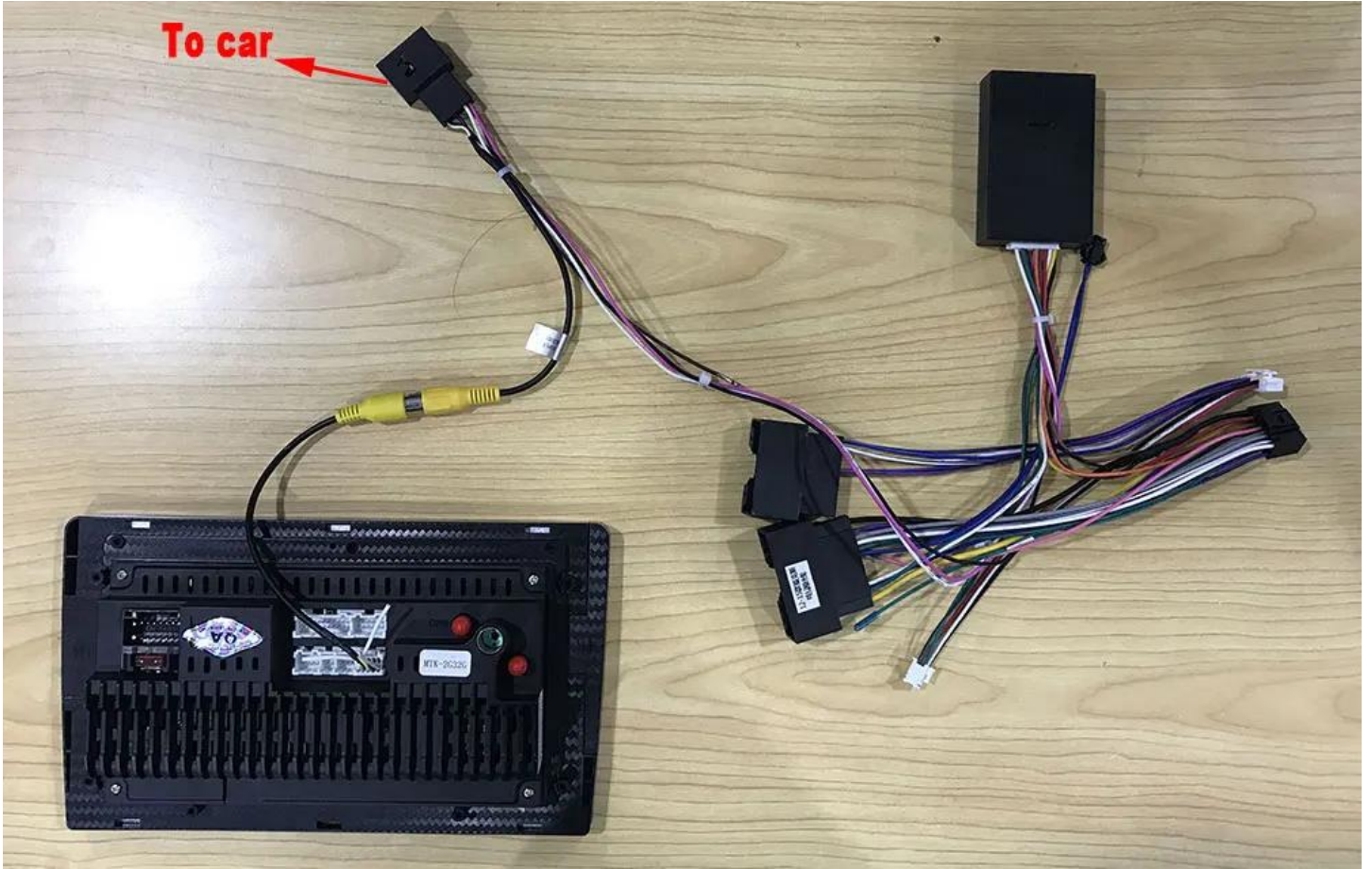

2. Connect AHD rear camera(cable with canbus):

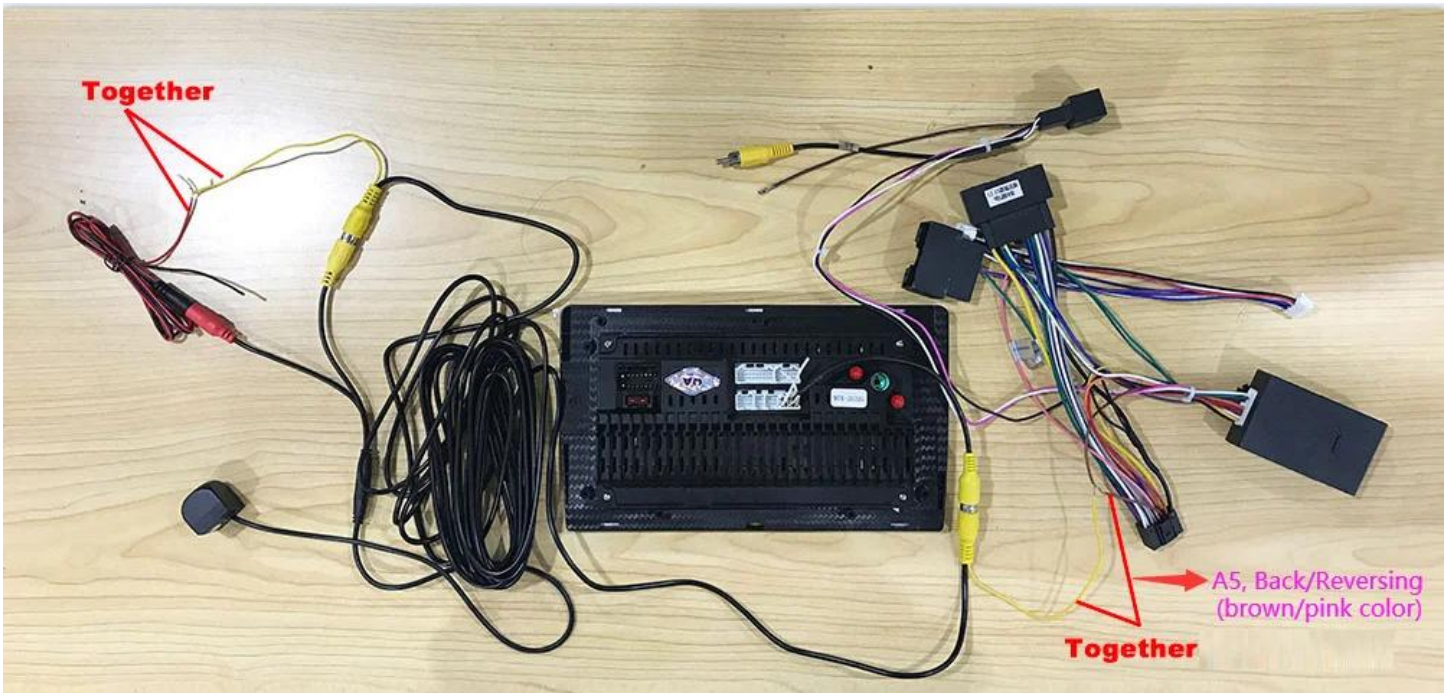

3. Connect AHD rear camera(cable without canbus):

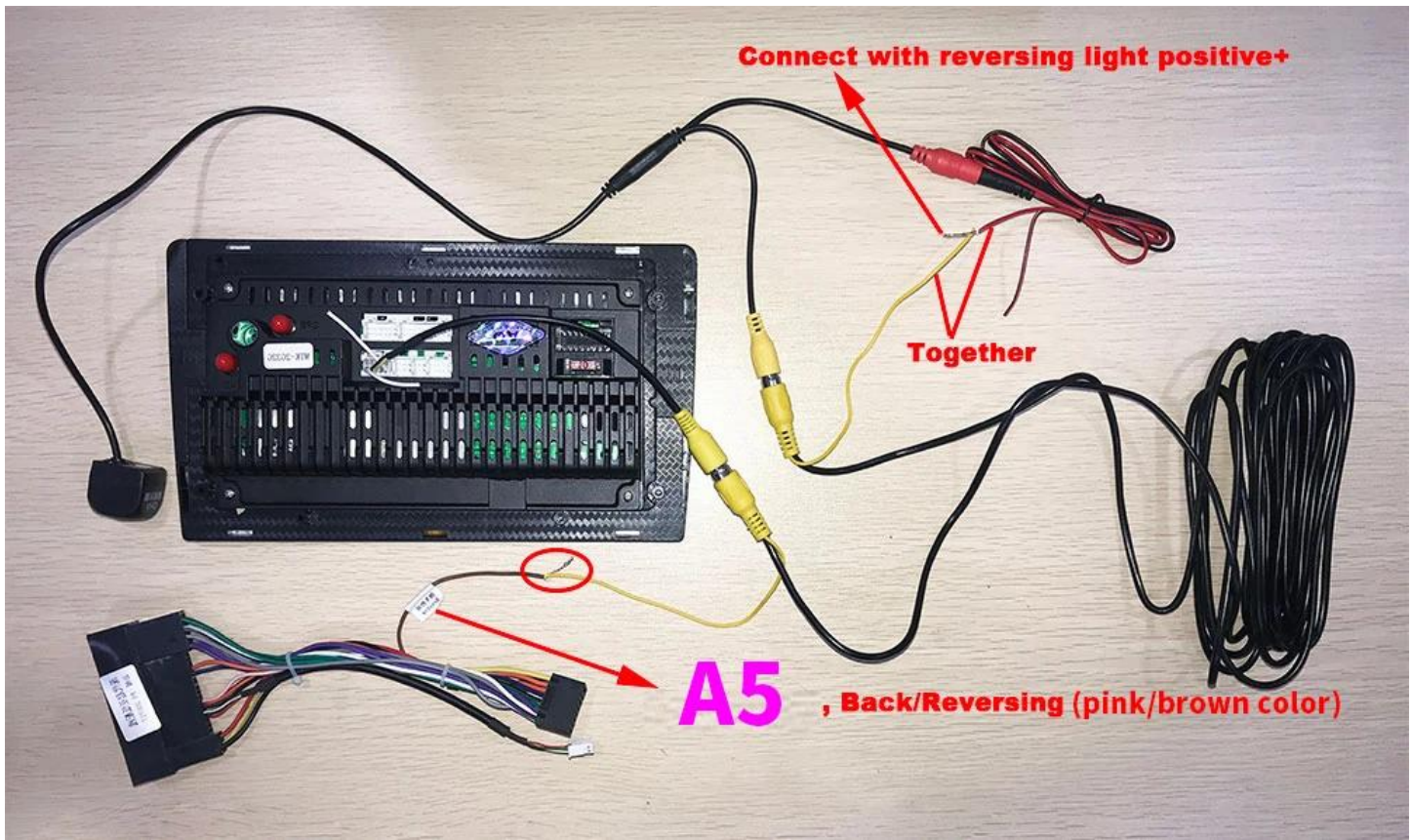

Connect with reversing light positive+

Together

**A5** , Back/Reversing (pink/brown color)

**How to plug built-in cooling fan:**

Like this picture to plug.(The RCA cable have cooling fan connector can plug with built-in cooling fan)

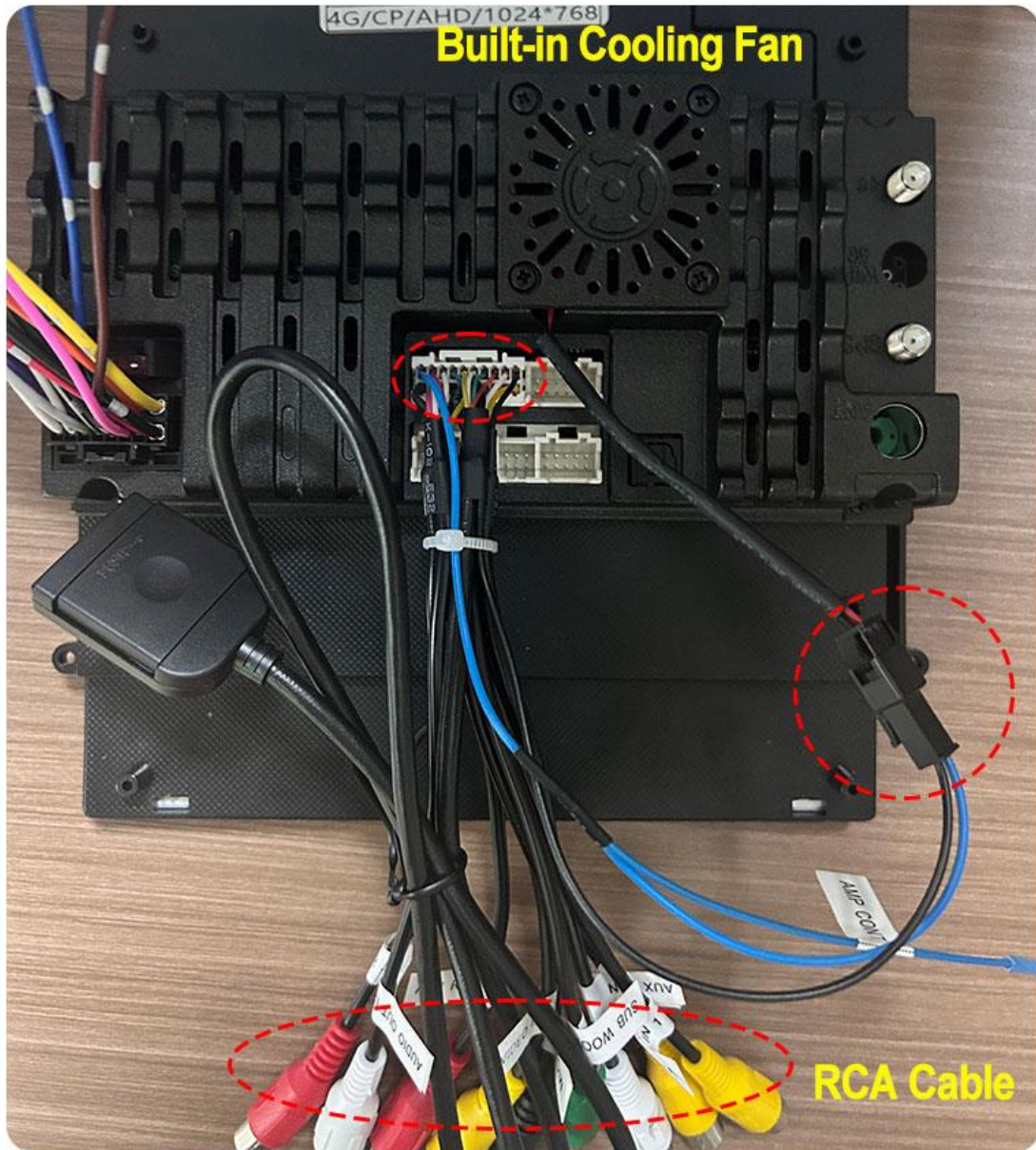

**How to plug extra microphone:**

Like this picture to plug.(The RCA cable have "MIC" connector can plug with extra microphone)

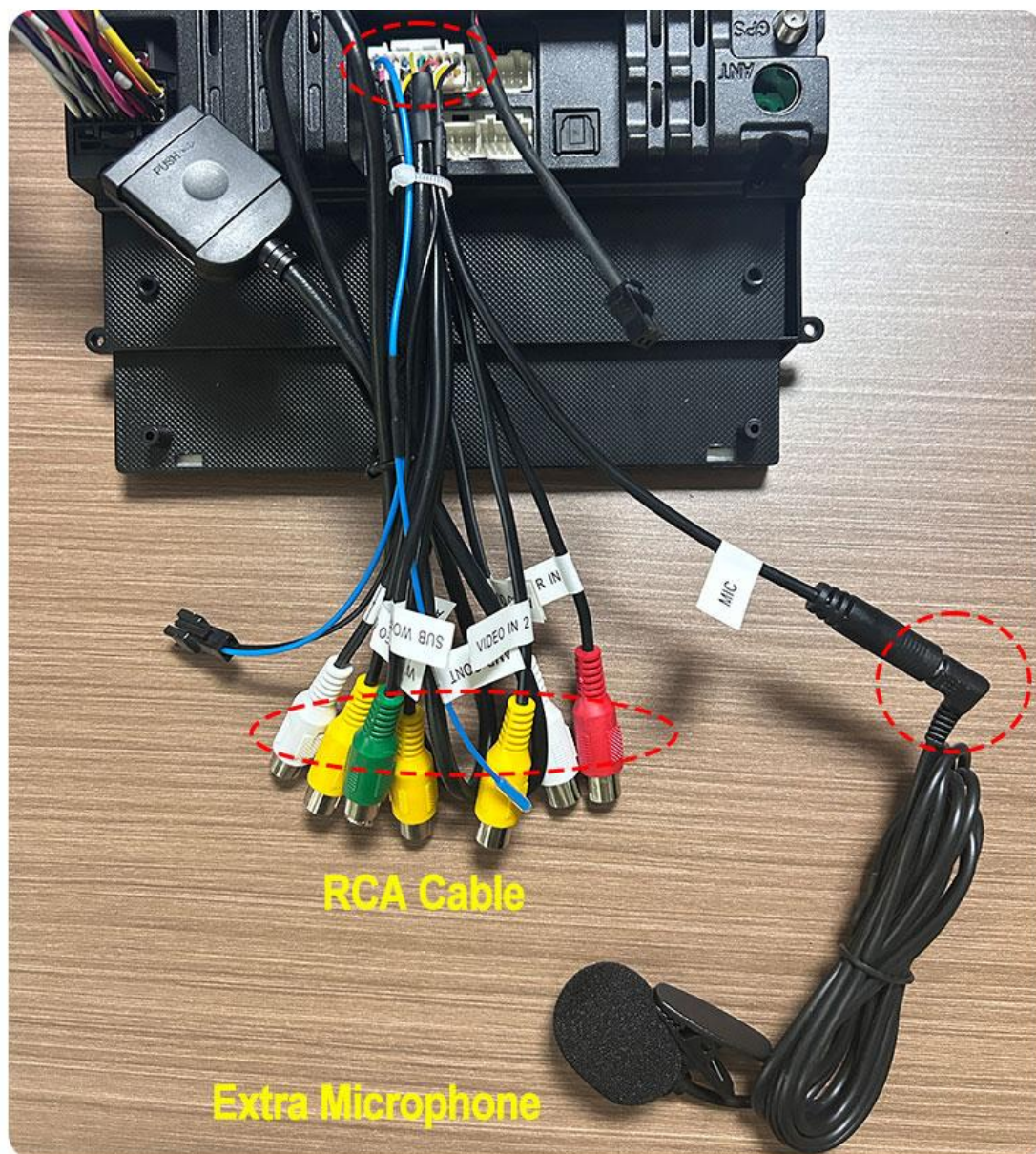

### How to plug Subwoofer:

Like this picture to plug.(The RCA cable have "SUB WOOFER" connector can plug )

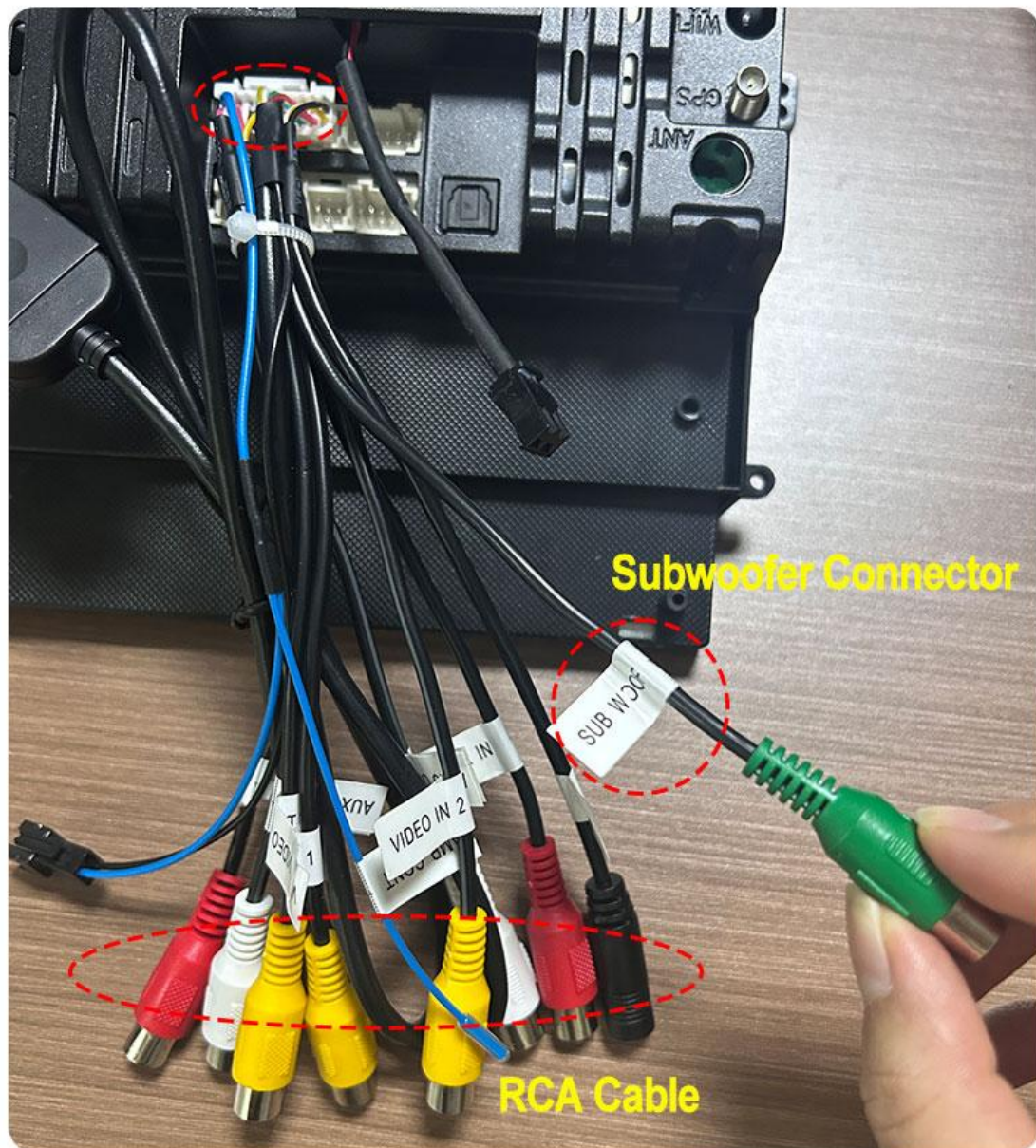

**How to plug our X5 1080P USB DVR:**

1. Please plug our DVR by **6Pin** USB cable,
2. Click "File manager" APP to install "Fvdvr"APP,very easy.

Like this video to do

<https://video.aliexpress-media.com/seller/play/5000385830987.mp4>



How to reset factory setting:

Please go to Setting-----System-----Reset factory-----7890

