

Goldair™



Operating Instructions

110cm Tower Fan



Model: GCTF110

General Care and Safety Guide

Thank you for choosing this Goldair Select product. This appliance has been designed and manufactured to high standards of engineering and with proper use and care, as described in this leaflet, will give you years of useful service. Please read these instructions carefully and keep them for future reference.

1. This appliance is not intended for use by persons (including children) with reduced physical, sensory or mental capabilities, or lack of experience and knowledge, unless they have been given supervision or instruction concerning use of the appliance by a person responsible for their safety.
2. Children should be supervised to ensure that they do not play with the appliance.
3. If the supply cord is damaged, it must be replaced by the manufacturer, its service agent or similarly qualified persons in order to avoid a hazard.
4. Ensure that the fan is switched off from the supply mains before removing the guard.
5. Use only the voltage specified on the rating plate of the appliance.
6. Keep all objects at least 1 Metre from the front, sides and rear of the appliance
7. This appliance is intended for household use only and not for commercial or industrial use.
8. Use this appliance only as described in this manual. Any other use is not recommended by the manufacturer and may cause fire, electric shock or injury.
9. The common cause of overheating is deposits of dust or fluff in the appliance. Ensure these deposits are removed regularly by unplugging the appliance and vacuum cleaning the air vents and grills.
10. Always unplug appliance when not in use.
11. When the appliance has been unpacked, check it for transport damage and ensure all parts have been delivered. If parts are missing or the appliance has been damaged, contact the Customer Services Team.
12. If your appliance does not work, or is not working properly, contact the place of purchase. Repair work on the appliance by unqualified persons can cause serious risk to the user.
13. Ensure hands are dry before handling the plug or the main unit.
14. Carry out regular checks of the supply cord to ensure no damage is evident.
15. Ensure that the cord is fully extended (not coiled) while in use.
16. Avoid contact with the moving parts. Keep hands, hair, clothing, away from blade of the fan during operation to reduce the risk of injury to person and/or damage to the unit.
17. Switch off and use handles provided when moving.
18. It is recommended that this fan is plugged directly into the wall socket.
19. A correctly specified, undamaged extension cord may be used with this fan provided it is used in a safe manner.

General Care and Safety Guide

20. Never place appliance close to radiant heat source.
21. Never operate in areas where petrol, paint or other flammable liquids are used or stored.
22. Never use the appliance to dry clothes.
23. Never insert or allow foreign objects to enter any ventilation or exhaust opening, as this may cause an electric shock, fire or damage to the appliance.
24. Never use abrasive cleaning products on this appliance. Clean with a damp cloth (not wet) rinsed in hot soapy water only. Always remove plug from the mains supply before cleaning.
25. Never connect the appliance to mains supply until completely assembled and adjusted.
26. Never remove plug from power socket until the appliance has been switched off.
27. Never remove plug from power socket by pulling cord – always grip plug.
28. Never twist, kink or wrap the cord around the appliance, as this may cause the insulation to weaken and split. Always ensure that all cord has been removed from any cord storage area and is unrolled before use.
29. Never use this appliance in the immediate surrounds of a bath, a shower, or a swimming pool or other liquids. The appliance must not be immersed in any liquids.
30. Due to the risk of injury, never use this appliance for any purpose other than its intended use. This appliance is intended for use in household and similar applications such as staff kitchen areas in shops, offices and other working environments; farm houses, by clients in hotels, motels, bed and breakfast type environments and other residential type environments
31. Never use this appliance outdoors.
32. Never operate the appliance with a damaged cord or plug, after it malfunctions, or if it has been damaged in any manner. Have the appliance checked and repaired by a qualified electrician if repair is necessary.
33. Never place the unit in wardrobes or other enclosed spaces as this may cause fire hazards.



General Care and Safety Guide

The remote control supplied with this fan uses a CR2025 coin type battery.

DANGER IF SWALLOWED

Keep batteries out of reach of children. Swallowing may lead to serious injury or death in as little as 2 hours due to internal burns.

If swallowed, go straight to a hospital emergency room.

Dispose of used batteries immediately.

WARNING!



DANGER IF SWALLOWED

Keep batteries out of reach of children. Swallowing may lead to serious injury or death in as little as 2 hours due to internal burns.

If swallowed, go straight to a hospital emergency room.

Dispose of used batteries immediately.

Components

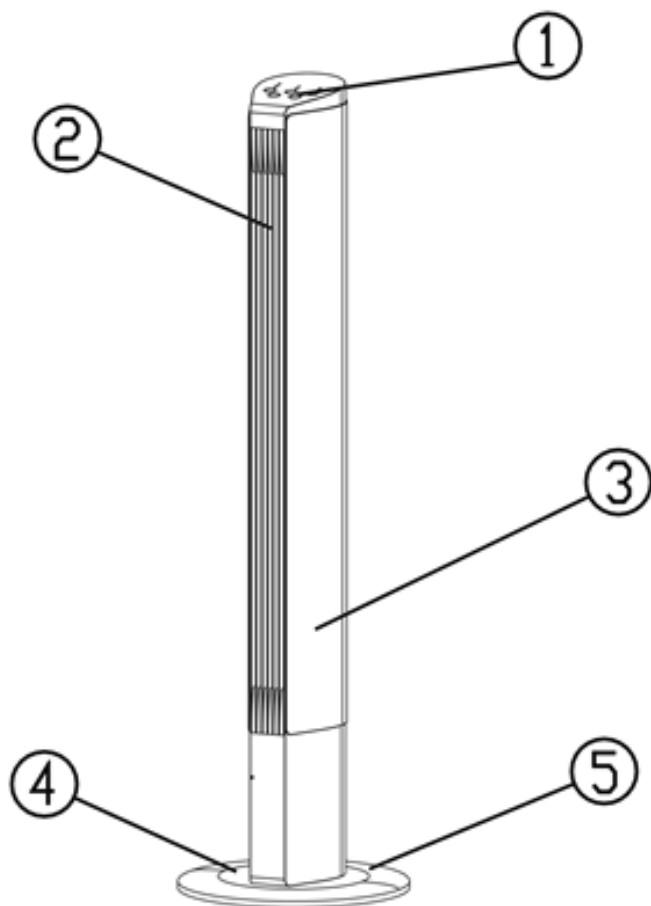

1. Control panel

2. Air outlet

3. Body

4. Base-front

5. Base-rear



Assembly

Always unplug the appliance before you assemble.

Do not attempt to use the fan until it has been fully assembled.

1. Run the power cord through the central gap between the 2 halves of the base.
2. Connect the 2 halves of the base by pushing the plastic pegs on each half into the corresponding slots on the other half.
3. Move the base into position and fully tighten it to the main body with the screws provided.
4. Pass the power cord through the guides on the base so that it comes out the rear of the base.

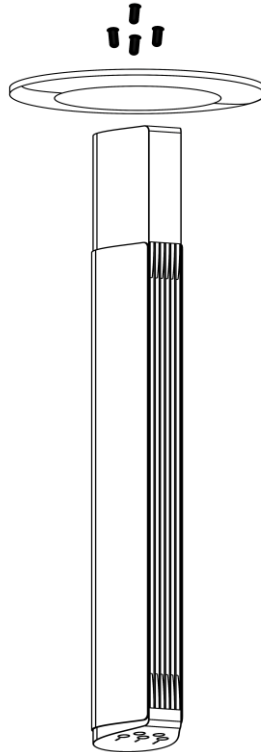
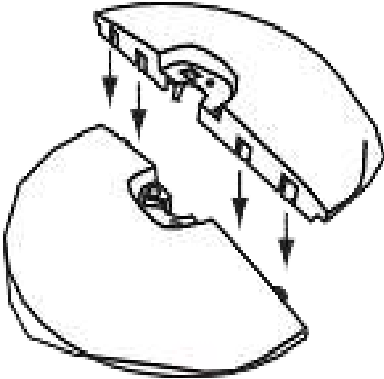



Operating your Fan

Always choose a safe location for the fan, keeping in mind the safety precautions outlined. Ensure all packaging has been removed from the unit before use. This appliance requires no installation, it should be used solely as a portable appliance.

WARNING: Keep all objects at least 1 metre from the front, sides and rear of the appliance. Place the fan on a dry, level and sturdy surface.

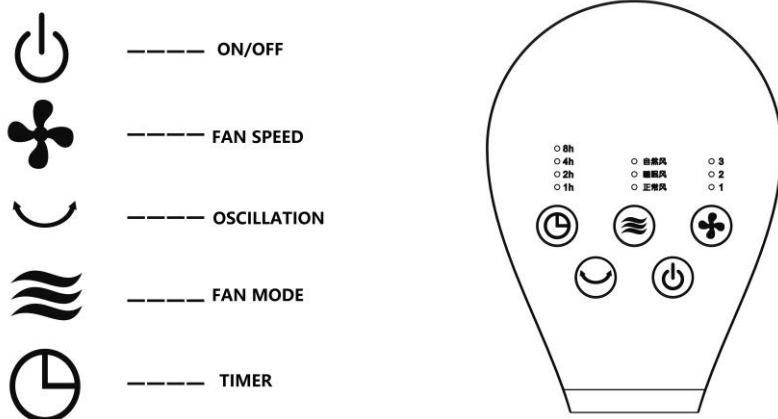
IMPORTANT! NEVER COVER THIS APPLIANCE!



Power 
Press power button to turn the fan ON or OFF.

Wind Speed 
Press speed button to set speed from 1 (low) to 3 (high).

Wind Mode 
Press mode button to set Normal mode, Sleeping mode and Natural mode.

Timer 
On Timer – when in standby, press the timer button to set a time to turn on from 1-15 hours in 1 hour increments.
Off Timer – when fan is running, press the timer button to set a time to turn off from 1-15 hours in 1 hour increments.
To cancel a timer press the timer button until it reads zero.

Oscillation 
Press OSC button to set oscillation from left to right. Press again to turn off.

Operating your Fan

Remote control

The remote requires a line-of-sight path to allow for the signal to be received by the unit. Position the unit so the receiver lens is visible from the remote control.

The symbols on the remote correspond to the symbols on the main unit.

The remote control supplied with this fan uses a CR2025 coin type battery.

DANGER IF SWALLOWED

Keep batteries out of reach of children. Swallowing may lead to serious injury or death in as little as 2 hours due to internal burns.

If swallowed, go straight to a hospital emergency room.

Dispose of used batteries immediately.



Cleaning

The fan requires regular cleaning to ensure trouble free operation.

Ensure that the fan is switched off from the supply mains before removing the guard.

Unplug the fan from the mains supply before cleaning.

Use a damp cloth (not wet) to wipe the exterior of the fan to remove dust and dirt.

Use a vacuum cleaner to remove dust and fluff from around the grills.

Ensure the fan is dry before plugging back into the mains supply.

Do not attempt to dismantle the fan. There are no user serviceable parts. For service or repair, contact an authorised electrical service technician.

Proof of purchase

To receive warranty retain receipt as proof of purchase. (Refer to back of booklet).

Goldair™

SUPPORT AND TECHNICAL ADVICE

Goldair – New Zealand

Monday – Friday 8am-5pm

Phone +64 (0)9 917 4000

Phone 0800 232 633

info@cdb.co.nz

Goldair – Australia

Monday – Friday 8am-5pm

Phone +61 (0)3 9365 5100

Phone 1300 465 324

info@cdbgoldair.com.au



One Year Warranty

Thank you for purchasing this Goldair Select product. Your product is warranted against faults and manufacture when used in normal domestic use for a period of **one year**. In non-domestic use Goldair limits the voluntary warranty to **three months**.

Goldair undertake to repair or replace this product at no charge if found to be defective due to a manufacturing fault during the warranty period.

This warranty excludes damage caused by misuse, neglect, shipping accident, incorrect installation, or work carried out by anyone other than a qualified electrical service technician.

PLEASE KEEP YOUR RECEIPT AS THIS WILL HELP VERIFY YOUR WARRANTY.

The benefits to you given by this warranty are in addition to other rights and remedies available to you under a law in relation to the goods or services to which this warranty relates.

In Australia, our goods come with guarantees that cannot be excluded under the Australian Consumer Law. You are entitled to a replacement or refund for a major failure and compensation for any other reasonably foreseeable loss or damage. You are also entitled to have the goods repaired or replaced if the goods fail to be of acceptable quality and the failure does not amount to a major failure.

In New Zealand this warranty is additional to the conditions and guarantees of the Consumers Guarantee Act (1993).

Goldair – New Zealand

CDB Goldair
PO Box 100-707
N.S.M.C
Auckland, 0745

Phone +64 (0)9 917 4000

Phone 0800 232 633

www.goldair.co.nz

Goldair – Australia

CDB Goldair Australia Pty
PO Box 574
South Morang
Victoria, 3752

Phone +61 (0)3 9365 5100

Phone 1300 GOLDAIR (1300 465 324)

www.goldair.com.au

Goldair One Year Warranty (IMPORTANT: Please complete and retain this warranty card)

Name _____

Address _____

Place Of Purchase _____ Date of Purchase _____

Name Of Product _____ Model Number _____

Attach a copy of the purchase receipt to this warranty card

Due to continual design improvements, the product illustrated in this User Manual may differ slightly from the actual product.

Goldair™



CDB  Goldair™

New Zealand
PO Box 100707,
North Shore Mail Centre,
Auckland, 0745
www.goldair.co.nz

Australia
PO Box 574,
South Morang,
Victoria, 3752
www.goldair.com.au