

8+



TRANSFORMERS



STUDIO SERIES
THE TRANSFORMERS
THE MOVIE

DECEPTICON FRENZY (RED)
变形金刚工作室系列
86大电影核心级迷乱

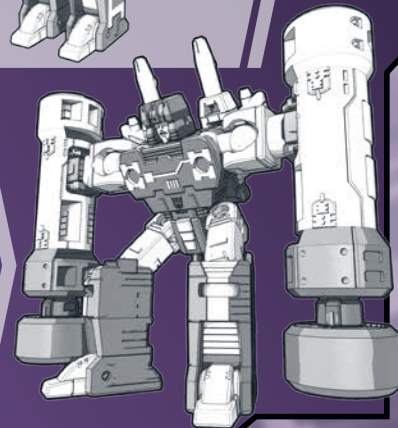
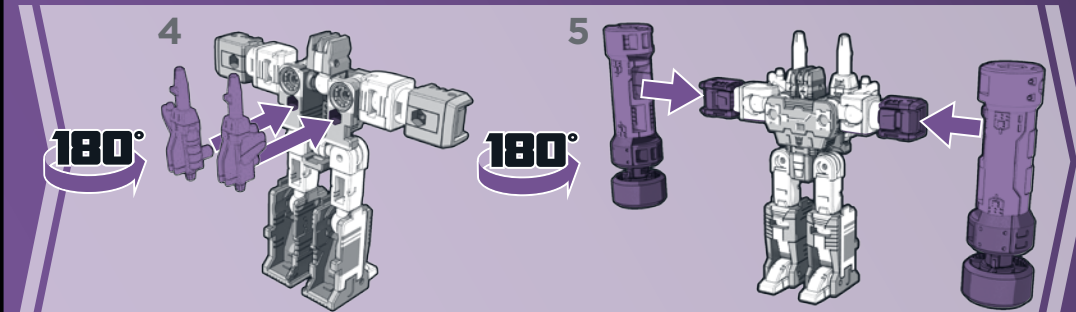
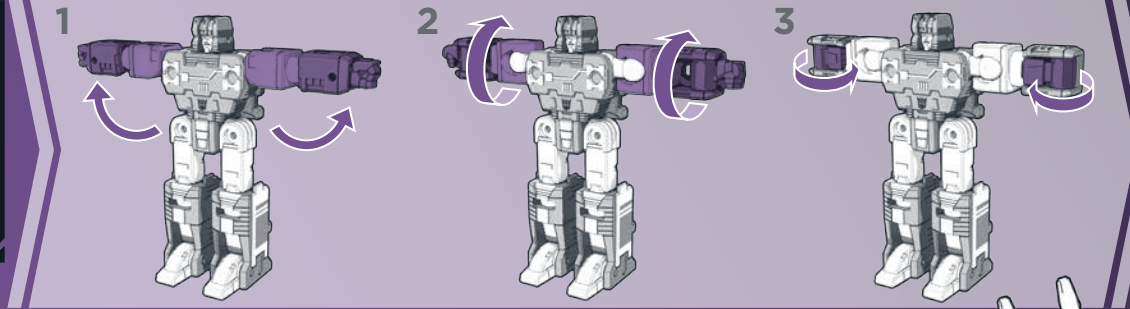
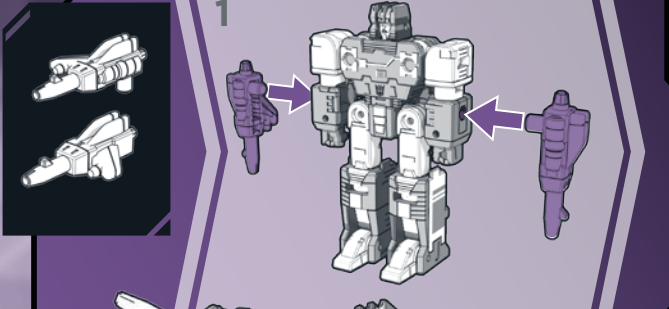



变形金刚
官方微信

1123F7492XC00

产品和颜色可能会有差异。

更多信息请搜索孩之宝中国微信号。

请保留使用说明书以备将来参考。

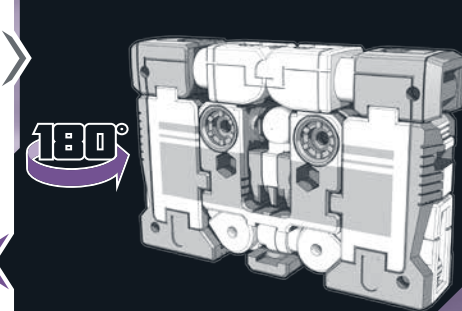
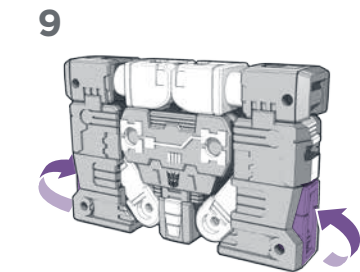
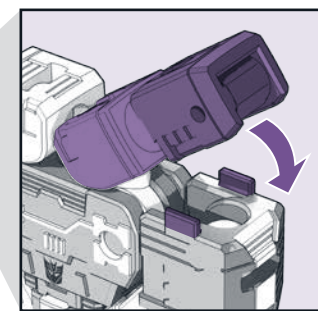
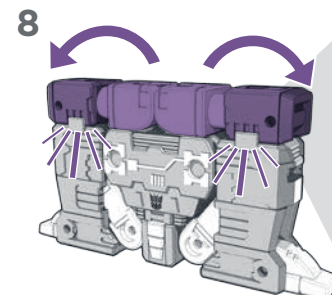
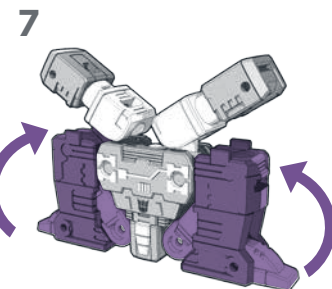
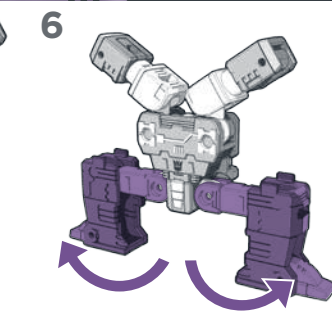
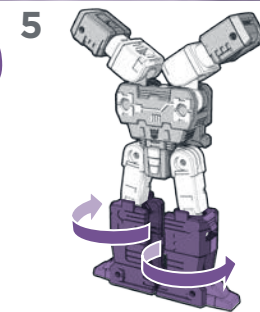
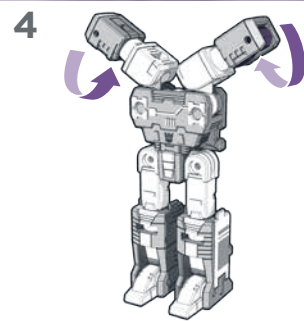
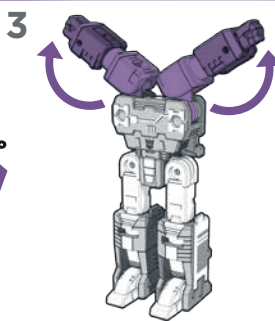
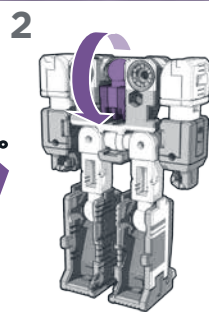
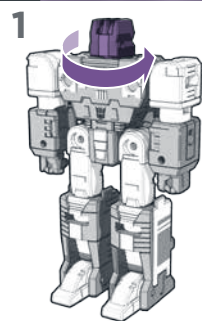
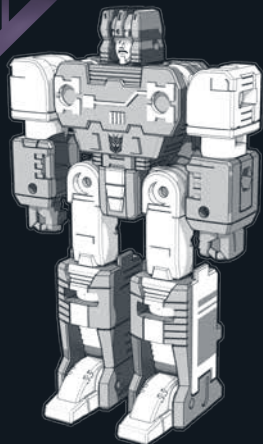

Manufactured under license from TOMY Company, Ltd. TAKARATOMY logo is property of Tomy Company, Ltd. TRANSFORMERS and HASBRO and all related trademarks and logos are trademarks of Hasbro, Inc. © 2023 Hasbro.

Hasbro, Pawtucket, RI 02861-1059 USA. HASBRO CANADA, LONGUEUIL, QC, CANADA J4G 1G2. US/CANADA TEL. 1-800-255-5516. Importado por: HASBRO DE MÉXICO, S. DE R.L. DE C.V. Boulevard Manuel Ávila Camacho #32, piso 3, Colonia Lomas de Chapultepec I Sección, Alcaldía Miguel Hidalgo, C.P. 11000, Ciudad de México, México. Centro de Servicio para México: TEL. 5876-2998 y para el interior de la República TEL. 01-800-7-12-62-25. Manufactured by/Produit de: Hasbro SA, Rue Emile-Boéchat 31, 2800 Delémont, CH. Represented by/Reprezentat de: Hasbro, De Entree 240, 1101 EE Amsterdam, NL. © Hasbro UK Ltd., P.O. Box 43, Newport, NP19 4YH, UK. © Üretici Firma Bilgileri: Hasbro SA, Rue Emile-Boéchat 31, 2800 Delémont Suisse TEL +41 324210800. Hasbro Oyuncak San. ve Tic. A.Ş. tarafından ithal edilmiştir. Tüketici Hizmetleri: Burhaniye Mah. Abdullahağa Cad. No: 51/2 34676 Beylerbeyi İstanbul Türkiye TEL +90 2164229010.



F7492/F3135 Asst.