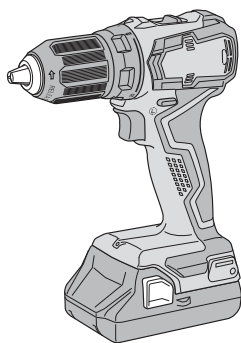


# HiKOKI

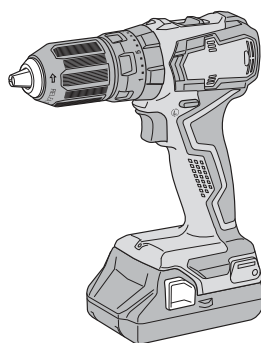
充电式起子电钻 / 冲击起子电钻  
Cordless Driver Drill / Impact Driver Drill

中文  
English

## DS 18DD • DV 18DD



DS18DD



DV18DD

保留备用  
Keep for future reference



使用说明书  
Handling instructions

## 目次

电动工具通用安全警告.....	2	用途.....	10
充电式起子电钻 /		电池的拆卸 / 安装法.....	11
冲击起子电钻安全警告.....	4	充电.....	11
其它安全警告.....	5	作业之前.....	14
锂离子电池使用注意事项.....	6	使用方法.....	14
锂离子电池运输.....	7	操作上的注意事项.....	22
符号.....	7	维护和检查.....	22
零件名称.....	8	故障排除.....	24
规格.....	9	选择附件.....	26
标准附件.....	10		

## 电动工具通用安全警告

### ⚠ 警告！

阅读所有警告和所有说明。

不遵照以下警告和说明会导致电击、着火和 / 或严重伤害。

保存所有警告和说明书以备查阅。

在所有下列的警告中术语“电动工具”指市电驱动（有线）电动工具或电池驱动（无线）电动工具。

#### 1) 工作场地的安全

- a) 保持工作场地清洁和明亮。  
混乱和黑暗的场地会引发事故。
- b) 不要在易爆环境，如有易燃液体、气体或粉尘的环境下操作电动工具。  
电动工具产生的火花会点燃粉尘或气体。
- c) 让儿童和旁观者离开后操作电动工具。  
注意力不集中会使操作者失去对工具的控制。

#### 2) 电气安全

- a) 电动工具插头必须与插座相配。绝不能以任何方式改装插头。  
需接地的电动工具不能使用任何转换插头。  
未经改装的插头和相配的插座将减少电击危险。
- b) 避免人体接触接地表面，如管道、散热片和冰箱。  
如果你身体接地会增加电击危险。
- c) 不得将电动工具暴露在雨中或潮湿环境中。  
水进入电动工具将增加电击危险。

- d) 不得滥用电线。绝不能用电线搬运、拉动电动工具或拔出其插头。  
使电线远离热源、油、锐边或运动部件。  
受损或缠绕的软线会增加电击危险。
- e) 当在户外使用电动工具时，使用适合户外使用的外接软线。  
适合户外使用的软线将减少电击危险。
- f) 如果在潮湿环境下操作电动工具是不可避免的，应使用剩余电流动作保护器（RCD）。  
使用RCD可减小电击危险。

### 3) 人身安全

- a) 保持警觉，当操作电动工具时关注所从事的操作并保持清醒。  
当你感到疲倦，或在有药物、酒精或治疗反应时，不要操作电动工具。  
在操作电动工具时瞬间的疏忽会导致严重人身伤害。
- b) 使用个人防护装置。始终佩戴护目镜。  
安全装置，诸如适当条件下使用防尘面具、防滑安全鞋、安全帽、听力防护等装置能减少人身伤害。
- c) 防止意外起动。确保开关在连接电源和 / 或电池盒、拿起或搬运工具时处于关断位置。  
手指放在已接通电源的开关上或开关处于接通时插入插头可能会导致危险。
- d) 在电动工具接通之前，拿掉所有调节钥匙或扳手。  
遗留在电动工具旋转零件上的扳手或钥匙会导致人身伤害。
- e) 手不要伸展得太长。时刻注意立足点和身体平衡。  
这样在意外情况下能很好地控制电动工具。
- f) 着装适当。不要穿宽松衣服或佩戴饰品。让衣服、手套和头发远离运动部件。  
宽松衣服、佩饰或长发可能会卷入运动部件中。
- g) 如果提供了与排屑、集尘设备连接用的装置，要确保它们连接完好且使用得当。  
使用这些装置可减少尘屑引起的危险。

### 4) 电动工具使用和注意事项

- a) 不要滥用电动工具，根据用途使用适当的电动工具。  
选用适当设计的电动工具会使你工作更有效、更安全。
- b) 如果开关不能接通或关断工具电源，则不能使用该电动工具。  
不能用开关来控制的电动工具是危险的且必须进行修理。
- c) 在进行任何调节、更换附件或贮存电动工具之前，必须从电源上拔掉插头和 / 或使电池盒与工具脱开。  
这种防护性措施将减少工具意外起动的危险。
- d) 将闲置不用的电动工具贮存在儿童所及范围之外，并且不要让不熟悉电动工具或对这些说明不了解的人操作电动工具。  
电动工具在未经培训的用户手中是危险的。

- e) 保养电动工具。检查运动件是否调整到位或卡住，检查零件破损情况和影响电动工具运行的其他状况。  
如有损坏，电动工具应在使用前修理好。  
许多事故由维护不良的电动工具引发。
- f) 保持切削刀具锋利和清洁。  
保养良好的有锋利切削刃的刀具不易卡住而且容易控制。
- g) 按照使用说明书，考虑作业条件和进行的作业来使用电动工具、附件和工具的刀头等。  
将电动工具用于那些与其用途不符的操作可能会导致危险。

### 5) 电池式工具使用和注意事项

- a) 只用制造商规定的充电器充电。  
将适用于某种电池盒的充电器用到其他电池盒时会发生着火危险。
- b) 只使用配有特制电池盒的电动工具。  
使用其他电池盒会发生损坏和着火危险。
- c) 当电池盒不用时，将它远离其他金属物体，例如回形针、硬币、钥匙、钉子、螺钉或其他小金属物体，以防一端与另一端连接。  
电池端部短路会引起燃烧或火灾。
- d) 在滥用条件下，液体会从电池中溅出；避免接触。如果无意间碰到了，用水冲洗。如果液体碰到了眼睛，还要寻求医疗帮助。  
从电池中溅出的液体会发生腐蚀或燃烧。

### 6) 维修

- a) 将你的电动工具送交专业维修人员，使用同样的备件进行修理。  
这样将确保所维修的电动工具的安全性。

## 注意！

不可让儿童和体弱人士靠近工作场所。

应将不使用的工具存放在儿童和体弱人士接触不到的地方。

## 充电式起子电钻 / 冲击起子电钻安全警告

<DV18DD>

- 1. 在进行冲击电钻时要戴好耳罩。  
暴露在噪声中会引起听力损伤。

<DS18DD / DV18DD>

- 1. 在执行切割附件或紧固件会接触到暗线的操作时，通过绝缘的抓紧表面拿住电动工具。  
接触“带电”电线的切割附件或紧固件会使电动工具的裸露金属部件“带电”，并可能使操作员遭到电击。

## 其它安全警告

1. 确保打钻的区域绝对没有任何隐藏的障碍物，包括电线、水管或煤气管道。钻入上述物体可能导致触电或短路、煤气泄漏或其他可能造成严重事故或人员受伤的危险。
2. 操作期间，确保紧紧握住工具把手。否则将会造成伤害。
3. 固定工件。使用夹紧装置或老虎钳固定工件比手更牢固。
4. 工作环境的准备和检查  
请按下列注意事项检查工作环境是否适当。
5. 勿让杂质进入电池连结口内。
6. 切勿拆卸电池与充电器。
7. 切勿使电池短路。使电池短路将会造成很大的电流和过热，从而烧坏电池。
8. 请勿将电池丢入火中。  
电池受热将会爆炸。
9. 充电后电池寿命太短不够使用时，请尽快将电池送往经销店。请勿将用过的电池乱丢。
10. 请勿将异物插入充电器的通风口。  
若将金属异物或易燃物插入通风口的话，将会引起触电事故或使充电器受损。
11. 当把钻头装入无键夹盘时，请充分旋紧导套。如果导套没有旋紧，钻头则会松脱，从而造成伤害。
12. 工具过载时电机可能停止。如发生此种情况，请松开工具开关，并消除造成过载的原因。
13. 请勿使用工具或电池端子（电池安装部位）明显变形的产品。  
否则，安装电池后可能会短路，造成冒烟或起火。
14. 请清除工具端子（电池安装部位）上的削屑和灰尘。
  - 使用前请确保电池上没有堆积削屑和灰尘。
  - 在使用过程中，请尽量避免工具上的削屑或灰尘掉落在电池上。
  - 暂时不使用工具时或使用后，应将工具存放在不会掉落削屑或灰尘的地方。  
否则可能短路，造成冒烟或起火。
15. 务请在  $0^{\circ}\text{C} \sim 40^{\circ}\text{C}$  的温度下进行充电。温度低于  $0^{\circ}\text{C}$  将会导致充电过度，极其危险。电池不能在高于  $40^{\circ}\text{C}$  的温度下充电。  
最适合于充电的温度是  $20 \sim 25^{\circ}\text{C}$ 。

## 锂离子电池使用注意事项

为延长使用期限，锂离子电池备配停止输出的保护功能。

若是在使用本产品时发生下列 1 至 3 的情况，即使按下开关，马达也可能停止。这并非故障，而是启动保护功能的结果。

1. 在残留的电池电力即将耗尽时，马达会停止。  
在这种情况下，请立即予以充电。
  2. 若工具超过负荷，马达亦可能停止。在这种情况下，请松开工具的开关，试着消除超过负荷的原因。之后您就可以再度使用。
  3. 若电池在过载工作情况下过热，电池电力可能会中止。  
在这种情况下，请停止使用电池，让电池冷却。之后您就可以再度使用。
- 此外，请留心下列的警告及注意事项。

### 警告！

为防止发生电池漏电、发热、冒烟、爆炸及提前点燃，请确保留意下列事项。

1. 确保电池上没有堆积削屑及灰尘。
  - 在工作时确定削屑及灰尘没有掉落在电池上。
  - 确定所有工作时掉落在电动工具上的削屑和灰尘没有堆积在电池上。
  - 请勿将未使用的电池存放在曝露于削屑和灰尘的位置。
  - 在存放电池之前，请清除任何可能附着在上面的削屑和灰尘，并请切勿将它与金属零件（螺丝、钉子等）存放在一起。
2. 请勿以钉子等利器刺穿电池、以铁锤敲打、踩踏、丢掷电池，或将其剧烈撞击。
3. 切勿使用明显损坏或变形的电池。
4. 使用电池时请勿颠倒电极。
5. 请勿直接连接电源插座或汽车点烟器孔座。
6. 请依规定方式使用电池，切勿移作他用。
7. 如果已过了再充电时间，电池仍无法完成充电，请立即停止继续再充电。
8. 请勿将电池放置于高温或高压处，例如微波炉、烘干机或高压容器内。
9. 在发觉有渗漏或异味时，请勿接近远离火源。
10. 请勿在会产生强烈静电的地方使用。
11. 如有电池渗漏、异味、发热、褪色或变形，或在使用、充电或存放时出现任何异常，请立即将它从装备或电池充电器拆下，并停止使用。
12. 请勿浸泡电池或让任何液体流入电池内部。导电液体进入（如水），可能造成电池损坏，甚至可导致火灾或爆炸。将电池存放在阴凉、干燥的地方，远离易燃物品。必须避免将电池置于腐蚀性气体环境中。

### 注意！

1. 若电池渗漏出的液体进入您的眼睛，请勿搓揉眼睛，并以自来水等干净清水充分冲洗，立刻送医。  
若不加以处理，液体可能会导致眼睛不适。

- 若液体渗漏至您的皮肤或衣物，请立即以自来水等清水冲洗。  
上述情况可能会使皮肤受到刺激。
- 若初次使用电池时发现生锈、异味、过热、褪色、变形及 / 或其它异常情况时，请勿使用并将该电池退还给供货商或厂商。

### 警告！

如果导电异物接触到锂离子电池的端子，电池可能短路，并导致火灾。

存放锂离子电池时，请务必遵循下列注意事项。

- 切勿在存放盒中放置导电的残片，钉子，以及导线，如铁线和铜线。
- 为防止发生短路，应将电池装入工具中或者在存放时牢固地插入电池盖，直至看不到通风口。（参照图 1）

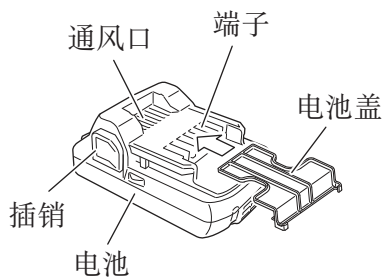


图 1

## 锂离子电池运输

当运输一个锂离子电池，请注意以下预防措施。

### 警告！

告知运输公司，包装内包含一个锂离子电池，告知该公司其功率输出并且要按照运输公司的指引安排运输。

- 功率输出超过 100 Wh 的锂离子电池被视作危险物品运输分类并且需要特别申请程序。
- 对于境外运输，您必须遵守国际法以及输入国的规章和条例。

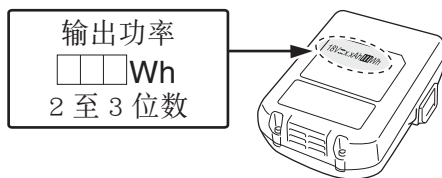


图 2

## 符号

### 警告！

如下所示的符号用于本机。使用前请务必理解其含意。

	为降低伤害风险，用户必须阅读使用说明书	$n_0$	无负荷速度
	直流电	/min	每分钟的振动次数
$V$	额定电压		警告

# 零件名称

## 1. 电动工具

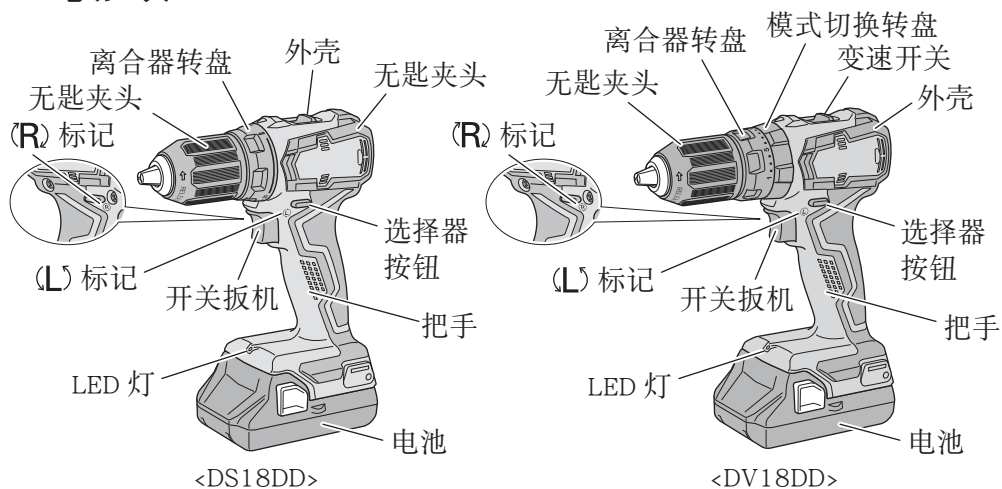
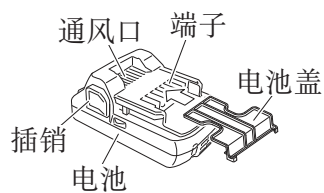
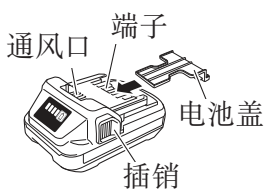


图 3

## 2. 电池



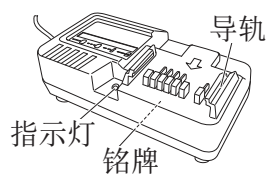
<BSL1830C>



<BSL1820M>

图 4

## 3. 充电器



<UC18YKSL>

图 5

## 规格

## 电动工具

型式		DS18DD	DV18DD	
电压		18 V		
空载转速	低	0—440 /min		
	高	0—1700 /min		
冲击率	低	—	0—6600 /min	
	高	—	0—25500 /min	
能力	钻孔	砖块 (深度 30 mm)	—	13 mm
		木料 (厚 38 mm)	36 mm (软木)	
		金属 (厚 1.6 mm)	钢材：13 mm 铝：13 mm	
	螺丝 紧固	木螺丝	6 mm (直径) × 75 mm (长) (应有导孔)	
		小螺丝	6 mm	
钻头夹盘容量		最大夹子直径 2.0—13 mm		
电池		BSL1830C：锂离子 18 V (3.0 Ah 5 节) BSL1820M：锂离子 18 V (2.0 Ah 5 节)		
重量		1.2 kg (装有 BSL1830C/ BSL1820M)	1.3 kg (装有 BSL1830C/ BSL1820M)	

## 充电器

型式	UC18YKSL
充电电压	14.4—18 V
重量	0.35 kg

## 标准附件

除了主机 (1 台) 外, 产品包中还包括表中所列的附件。

表 1

	DS18DD		DV18DD	
	(2MGK)	(2BGK)	(2MGK)	(2BGK)
 十字槽头螺丝刀头 (2 号)	1	1	1	1
 充电器 (UC18YKSL)	1	1	1	1
 电池 (BSL1830C)	2	—	2	—
 电池 (BSL1820M)	—	2	—	2
 电池盖	1	1	1	1
 塑料盒	1	1	1	1

## 用途

<DS18DD>

- 旋紧和拆除机用螺丝、木螺丝、自攻螺丝等。
- 钻各种金属。
- 钻各种木料。

<DV18DD>

- 在砖块和水泥块等上面钻孔。
- 旋紧和拆除机用螺丝、木螺丝、自攻螺丝等。
- 钻各种金属。
- 钻各种木料。

## 电池的拆卸 / 安装法

### 1. 电池的拆卸法

请先紧抓住把手、然后再推压电池插销以拆下电池（参照图 6）。

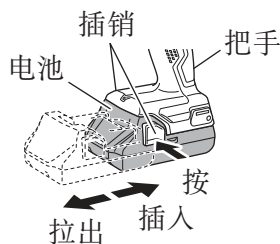


图 6

### 注意！

切勿使电池短路。

### 2. 电池的安装法

插入电池时请注意极性（参照图 6）。

## 充电

使用电动工具之前，按下述方法将电池进行充电。

### 1. 将充电器的电源线连接到插座。

将充电器插头连接到插座时，指示灯闪烁红色（间隔为 1 秒）。

### 2. 将电池插入充电器。

如图 7 所示，将电池紧紧地插入充电器。

### 3. 充电

将电池插入充电器后，将开始充电，指示灯会持续点亮呈红色。

电池完全充电后，指示灯将闪烁呈红色（以 1 秒的间隔）（参照如第 12 页的表 2）。

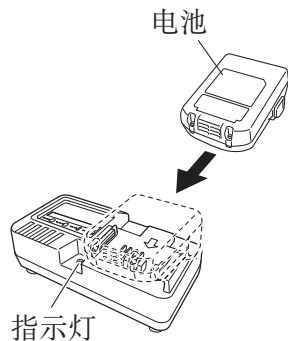







图 7

### ● 指示灯显示

根据充电器或电池的情况，指示灯的显示如第12页的表2所示。

表 2

指示灯的显示			
指示灯 (红色)	充电前	点亮 0.5 秒钟, 不点亮 0.5 秒钟 闪烁 (熄灭 0.5 秒钟) 	/
	充电时	点亮 连续点亮 	
	充电完成	点亮 0.5 秒钟, 不点亮 0.5 秒钟 闪烁 (熄灭 0.5 秒钟) 	
	过热而等待	点亮 1 秒钟, 不点亮 0.5 秒钟 闪烁 (熄灭 0.5 秒钟) 	电池过热。无法充 (电池冷却后开始进行充电)。
	无法充电	点亮 0.1 秒钟, 不点亮 0.1 秒钟 闪动 (熄灭 0.1 秒钟) 	电池或充电器有问题。

- 电池温度和充电时间相关资料。  
温度和充电时间如表 3 所示

表 3

电池		充电器	UC18YKSL
充电电压		V	14.4—18
重量		kg	0.35
电池可充电温度			0°C—50°C
电池容量的大致充电时间 (20°C 下)			
1.5 Ah	分钟		40
2.0 Ah	分钟		60
2.5 Ah	分钟		75
3.0 Ah	分钟		90
4.0 Ah	分钟		120
5.0 Ah	分钟		150
6.0 Ah	分钟		180
8.0 Ah	分钟		240
电池数			4—10

注:

充电时间可能根据环境温度和电压而有变化。

## 注意！

连续使用时，电池充电器温度将提升，因此会导致出现故障。完成充电后，下次充电前，请让电池充电器休息 15 分钟。

4. 从电源插座拔下充电器的电源线。
5. 握紧充电器并取出电池。

注：

充电后，先将电池从充电器中取出，然后妥善保管。

### 关于新电池的放电。

新电池内部的化学物质未被激活或电池长时间不使用时，初次或第二次使用时需要将其放电至较低电量。这只是暂时现象，将电池充电 2-3 次即可恢复为充电所需的正常时间。

### 较长时间保持电池性能的方法

- (1) 在电池电力完全耗尽之前进行充电。  
感到电动工具的能力变弱时，请停止使用并给电池充电。若您继续使用电动工具并耗尽电力，电池可能会损坏或其使用寿命缩短。
- (2) 避免在高温环境中充电。  
使用后可充电电池的温度将迅速升高。若使用后立即对这种电池进行充电，其内部化学物质会劣化，电池使用寿命将缩短。请稍等片刻，待电池冷却后再进行充电。

## 注意！

- 如果电池长时间放置在阳光直接照射的地方或者刚刚使用完毕时，电池会变热。如果此时对电池充电，充电器上的指示灯会点亮 1 秒钟，不点亮 0.5 秒钟（熄灭 0.5 秒钟）。  
在此情况下，先让电池冷却下来，然后再充电。
- 指示灯闪动时（以 0.2 秒钟的间隔），请检查并取出充电器电池接口处的任何异物。若无异物，则可能电池或充电器发生故障。请带去经授权的维修中心检查。
- 由于内置的微型计算机需要大约 3 秒钟来确认使用充电器充电的电池已取出，所以请等待至少 3 秒钟后再将电池重新插入继续充电。如果电池在 3 秒内重新插入，电池可能无法正常充电。
- 如果指示灯未以红色闪烁（每秒一次），但充电池电源线已连接至电源，表明充电器的保护电路可能已激活。  
拔下电源线或插座，然后等待 30 秒左右再次连接。如果指示灯仍未以红色闪烁（每秒一次），请将充电器送还至 HiKOKI 授权服务中心。

## 作业之前

检查工作区域，确保不混乱没有碎片。  
清理不必要人员区域。确保照明和通风充足。

## 使用方法

### 1. 钻头的安装和拆卸

#### (1) 安装钻头

左转导套（从前方看时为逆时针方向）将其旋松，以打开无键夹盘上的夹子。

当把起子机钻头插入无键钻机夹盘后，请紧握环，同时右转（从前方看时为顺时针方向）导套将其旋紧。（请参照图 8）

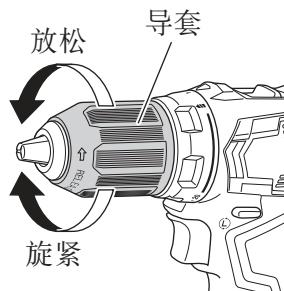


图 8

### 注意！

在无匙夹头中安装钻头时，请牢固拧紧。如果套筒不紧，则钻头可能会滑落或掉落，从而导致人身伤害。

### 注：

如果导套在作业中变松，应将其旋得再紧一些。

如果导套被旋得过紧，旋紧力则会变大。

#### (2) 拆卸钻头

左转导套（从前方看时为逆时针方向）将其旋松，然后取出钻头等。（请参照图 8）

### 注：

拧松卡住或难以移动的套筒。

用老虎钳或类似工具抓住装入无匙夹头的钻头。

将离合器拨盘位置设为“1-11”，并开启开关。电机随后启动。

最后，旋转套筒至左侧，然后其会松动。

### 2. 确认电池安装正确。

### 3. 检查旋转方向

按选择按钮的 R（右）侧，钻头便会顺时针（从后方看时）旋转；按选择按钮的 L（左）侧则使钻头逆时针旋转。（请参照图 9）。（L 和 R 标记随附在机身上。）

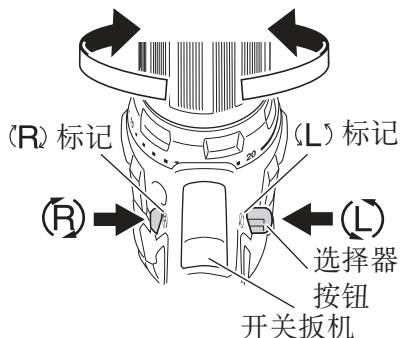


图 9

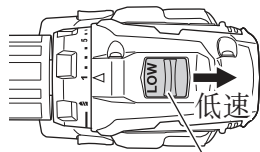
**注意！**

在电动工具转动期间，选择器按钮无法切换。要切换选择器按钮，需停止电动工具，然后设置选择器按钮。

## 4. 改变转速

请用变速开关来改变转速。请按箭头方向移动变速开关（请参照图 10 和图 11）。

如果变速开关被设在“LOW”位置，钻机则低速旋转；如果变速开关被设在“HIGH”位置，钻机则高速旋转。



变速开关

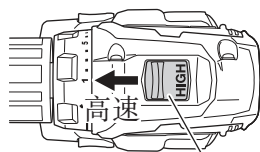
图 10

**注意！**

○ 当用变速开关改变转速时，应确保电源开关已被断开。

如果在马达旋转过程中改变速度，则会损坏齿轮。

○ 在需要较大的应力进行操作（下图中所示的操作）的时候，将变速开关设置为“LOW”。如果设置为“HIGH”并使用本机，那么可能会导致马达烧坏或者过早出现故障。



变速开关

图 11

## 5. 使用范围和建议

表 4 给出了基于本机机械结构的各种可用工作范围。


表 4

工作		拨盘位置	建议
钻孔	砖块 (DV18DD)	↑	用于钻孔。
	木料	▨	
	钢材		
	铝		
拧紧 螺丝	小螺丝	1—20	使用与螺丝直径相配的钻头或套筒。
	木螺丝	1—▨	钻好导孔后使用。

## 6. <DS18DD>

确认离合器转盘的位置（请参照图 12）

本机的旋紧转矩可根据离合器转盘的位置设定来调节。

- (1) 当把本机作为起子机使用时，请将离合器转盘上的“1、5、10……20”中的某个数字或点与机身外侧上的三角标记对齐。
- (2) 当把本机作为钻机来使用时，请将离合器转盘的钻机标记“”与机身外侧上的三角标记对齐。

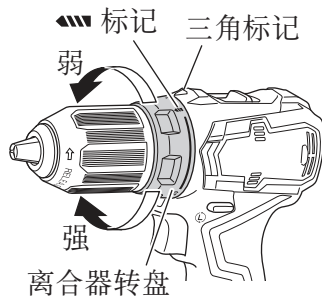



图 12

### 注意！

- 离合器转盘不能设在数字“1、5、10……20”之间或点之间
- 当离合器转盘位于“20”和钻机标记“”之间时，请勿使用本机，否则会造成损坏。（请参照图 13）

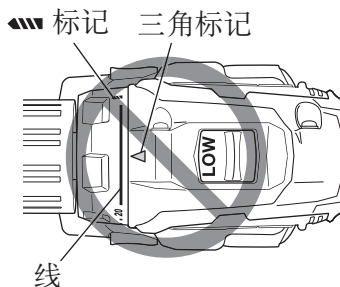




图 13

## 7. <DV18DD>

确认模式切换转盘和离合器转盘的位置（请参照图 14、15 和 16）

起子机、钻机和冲击钻三种模式可以通过本机中的模式切换转盘的位置来切换。

- (1) 当把本机作为起子机使用时，请将模式切换转盘上的螺钉拧紧标记“”与机身外侧上的三角标记对齐，并将离合器转盘上的“1、5、10……20”中的某个数字或点与机身外侧上的三角标记对齐（请参照图 14 和 15）。
- (2) 当把本机作为钻机使用时，请将模式切换转盘上的钻机标记“”与机身外侧上的三角标记对齐。
- (3) 当把本机作为冲击钻使用时，请将模式切换转盘上的锤子标记“**T**”与机身外侧上的三角标记对齐（请参照图 16）。

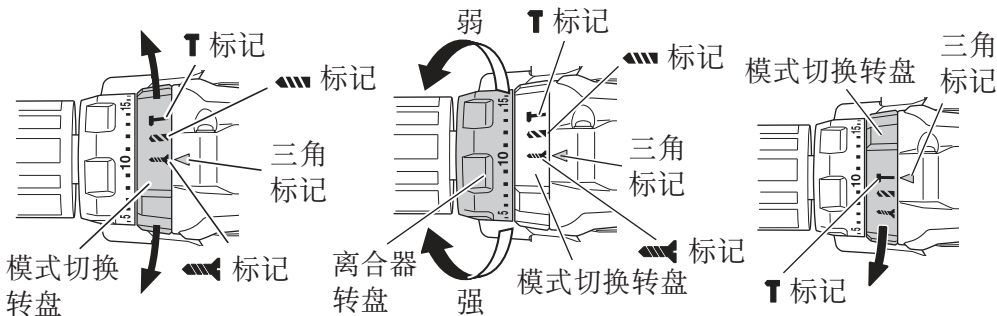


图 14



图 15

图 16

## 注意！


- 使用模式切换转盘时，应确保马达已停下。  
如果难以切换，请轻拉开关以让其略微旋转一下，然后再试着切换模式。
- 请确保完全切换模式切换转盘。  
在开关位于中间位置的情况下使用本工具可能会引起故障。
- 使用前请确保模式切换转盘在适当位置。  
否则不仅会降低效率，还可能损坏螺丝或钻机。
- 离合器转盘不能设在数字“1、5、10……20”之间或点之间。
- 在将本机用作冲击钻时，请务必顺时针转动使用本机（请参阅图 16）。

### 8. 旋转冲击切换 (DV18DD)

通过将电钻机标记“”或锤子标记“”对准外体上的三角标记，可以切换“旋转（只旋转）”和“冲击（冲击 + 旋转）”。

- 要在金属、木材或塑料上钻孔，请切换到“旋转（只旋转）”。
- 要在砖块和水泥块上钻孔，请切换到“冲击（冲击 + 旋转）”。

## 注意！

- 如果该材料只能旋转钻孔，注意不要在冲击设置中使用充电式冲击钻。这样的行为不仅会降低钻孔效率，也会损害钻头。
- 当拧紧 / 旋松金属 / 木头上的螺丝或钻孔时，请勿使用锤子标记“”（冲击 + 旋转）。  
否则不仅会降低效率，还可能损坏螺丝或钻机。
- 对于“旋转（只旋转）”和“冲击（冲击 + 旋转）”模式，无需调节离合器转盘。

### 9. 旋转转矩的调节

#### (1) 旋转转矩

旋转转矩的强度应与螺丝直径相对应。如果转矩过大，螺丝头则会损坏或受损。务请按螺丝直径来调节离合器转盘的位置。

#### (2) 旋转转矩的指示（请参照图 17）

螺丝类型及受紧固的材料不同，则旋转转矩也不同。

本机采用离合器转盘上的数字“1、5、10……20”以及线来指示旋转转矩。旋转转矩在位置“1”时最小，在最大数字处时最大。

#### (3) 调节旋转转矩（请参照图 17）

转动离合器转盘并使离合器转盘上的数字“1、5、10……20”或点与机身外侧上的三角标记对齐。按所需转矩将离合器转盘向小转矩或大转矩方向调节。

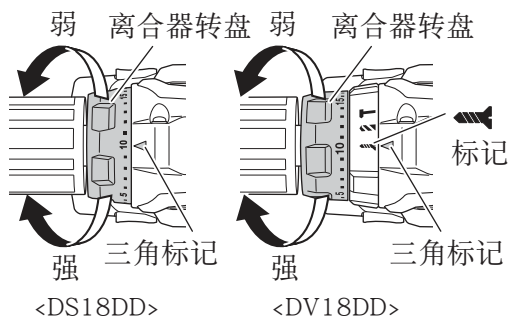


图 17

表 5 拧紧扭矩

离合器拨盘位置	拧紧扭矩
1	约 0.6 N-m
5	约 1.3 N-m
10	约 2.2 N-m
15	约 3.1 N-m
20	约 4.0 N-m

## 10. 开关操作

- 在降低开关扳机时，工具旋转。在释放扳机时，工具停止。在释放触发器开关的时候，将利用制动装置，立即停止运转。
- 钻头的旋转速度可通过变化拉动开关扳机的量进行控制。轻微拉动开关扳机时速度低，而开关扳机拉动增加时速度提升。

## 11. 在砖块上钻孔 (dv18dd)

过度按压力绝不会增加钻孔速度。这不但会损坏钻头或降低工作效率，同时也可能缩短钻头的使用寿命。在砖块上钻孔时以 10 - 20 kg 的按压力操作冲击起子电钻。

**注意！**

- 当把本机用作钻机时，马达可能会被锁住而停止转动。请在使用电动工具过程中不要锁住马达。
- 如果马达被锁住，则应立即断开电源。如果马达的锁定状态持续一会儿，马达或电池可能会被烧毁。
- 请勿过强地拧紧，因为此举会导致螺钉头损坏。

## 12. 如何选择转动速度



**注意！**

- 表 6 中给出的选择例子应作为一般标准来考虑。在实际工作中使用的都是不同类型的紧固螺丝和受紧固的材料，因此理应进行适当的调节。
- 在机用螺丝处于 HIGH（高速）的状态下使用电动工具时，因旋紧转矩过大，螺丝可能会损坏或钻头可能会松弛。使用机用螺丝时，请在 LOW（低速）的状态下使用电动工具。

## 注：

在寒冷环境（0℃ 以下）中使用电池有时会造成旋紧扭矩变弱以及作业量的减少。但是，这只是暂时现象，在电池变热后将会恢复正常。

表 6

工作		拨盘位置	转速选择（变速开关的位置）	
			LOW（低速）	HIGH（高速）
钻孔	木料		用于 36 mm 或更小的直径。	用于 18 mm 或更小的直径。
	金属		——	用于使用金属作业钻头进行钻孔。
拧紧螺丝	小螺丝	1-20	用于 6 mm 或更小的公称直径螺钉。	用于 6 mm 或更小的公称直径螺钉。
	木螺丝	1- 		用于 4.1 mm 或更小的公称直径螺钉。

### 13. 剩余电池电量指示灯

可以按下剩余电池电量指示灯开关点亮指示灯，查看电池的剩余电量。（图 18，第 20 页的表 7）

按住剩余电池电量指示灯开关约 3 秒后，指示灯将熄灭。

环境温度和电池状态可能会对剩余电池电量产生轻微的影响，因此，建议您仅将指示灯作为参考。

此外，电动工具或充电器上的剩余电池电量指示灯可能有所不同。

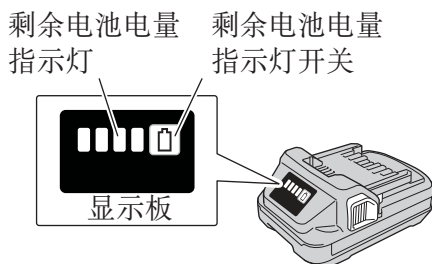







图 18

表 7

指示灯状态	电池剩余电量
	点亮； 电池剩余电量超过 75%
	点亮； 电池剩余电量为50%—75%
	点亮； 电池剩余电量为25%—50%
	点亮； 电池剩余电量不到 25%
	闪烁； 电池剩余电量即将耗尽。请尽快对电池进行充电。
	闪烁； 因高温暂停输出从电动工具中取下电池，让电池完全冷却。
	闪烁； 因失败或故障暂停输出。电池可能出现故障，请与经销商联系。

因为电池余量指示因环境温度和电池特性而略有不同，上表仅供参考。

注：

不要给显示板带来强震或折断它。这会引起麻烦。

#### 14.LED 灯使用方法

拔出开关后，LED 灯将自动点亮工具尖头部分（图 19）。

开关松开后，LED 灯将会自动关闭 10 秒钟。

LED 灯也具有警示信号功能，在使用期间点亮。

详情见“16.LED 灯警示信号”。

#### 注意！

- 请不要看着灯，让眼睛直接受灯光照射。如果眼睛持续受灯光照射，会伤害眼睛。

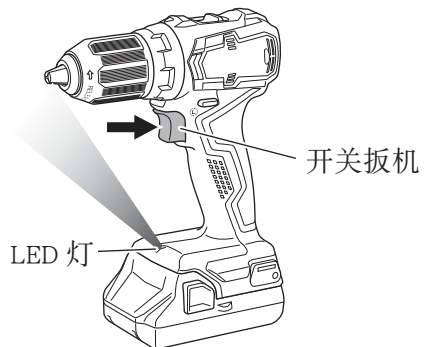


图 19

## 15. 使用挂钩件（单独销售）

挂钩用于在工作时将电动工具挂到腰带上。

**注意！**

- 使用挂钩时，牢固挂好挂钩，以防意外掉落。如果电动工具掉落，可能造成意外伤害。
- 在将电动工具悬挂于腰带上进行携带时，请勿将任何钻头安置于电动工具尖端。在将电动工具悬挂于腰带上携带时，如果如钻头等尖锐头安置于电动工具上，则您将会受伤。
- 将挂钩安装牢固。如果安装不牢固，在使用时可能造成伤害。

## (1) 安放挂钩并拧紧螺钉。

将挂钩牢固安装于电动工具的凹槽中，并拧紧螺钉以牢固固定挂钩（图 20）。

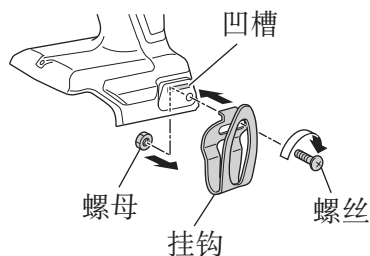


图 20

## (2) 拆下挂钩。

使用十字螺丝刀拆下固定挂钩的螺钉（图 21）。

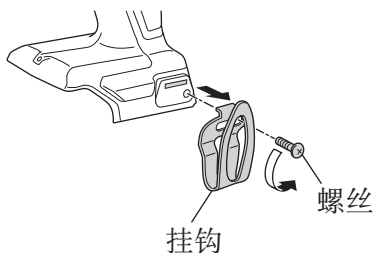


图 21

## 16. LED 灯警示信号（图 22）

该产品设计出具有保护该工具以及电池的功能。当拔出开关，如果在操作过程中任何保护功能启动，LED 灯将会如第 22 页的表 8 所描述的进行闪光。当启动任何保护功能，立即将您的手指从开关上移开并按照正确步骤所描述的指引进行操作。

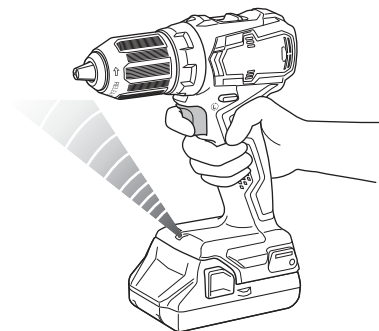


图 22

表 8

保护功能	LED 灯显示	正确步骤
负重过度保护	开启0.1秒/关闭0.5秒 ■      ■      ■      ■      ■	如果操作时变速开关为“高”，调节成“低”并继续操作。解除负担过重原因。
温度保护	开启0.3秒/关闭0.3秒 ■ ■ ■ ■ ■ ■ ■ ■ ■ ■	让该工具和电池得到充分冷却。

## 操作上的注意事项

连续作业后须让电动工具休息片刻

(1) 电动工具带有温度保护电路以保护马达。

连接进行紧固螺钉作业可能会使本机的温度上升，启动温度保护电路并自动停止操作。

如果发生这种情况，请让电动工具冷却后再使用。

(2) 在连续进行紧固木螺丝作业后以及在更换电池后，请让本机暂停作业 15 分钟。如果在更换电池后立刻开始作业，马达和开关等的温度将会升高，结果导致烧毁。

## 维护和检查

### 1. 检查工具

由于使用已经钝化的工具会降低效率并可能引起马达故障，因此一旦注意到磨损情况，就应及早磨快或更换工具。

### 2. 检查安装螺钉

要经常检查安装螺钉是否紧固妥善。若发现螺钉松了，应立即重新扭紧，否则会导致严重的事故。

### 3. 电动机的维护

电动机绕线是电动工具的“心脏部”应仔细检查有无损伤，是否被油液或水沾湿。

### 4. 检查端子（工具和电池）

确保端子上没有堆积削屑和灰尘。

在操作前、操作时和操作后需要时常检查。

## 注意！

请清除端子上的削屑或灰尘。

否则可能导致故障。

## 5. 清理外部

电动工具沾污时，用干软布或沾肥皂水的布擦拭。切勿使用氯溶液、汽油或稀释剂，以免塑胶部分溶化。

## 6. 收藏

电动工具应收藏于温度低于 40℃ 和小孩拿不到的地方。

### 注：

存放锂离子电池

在存放前请确保电池已完全充电。

电池在低电量的状态下长时间存放（3 个月或更长），可能会导致电池性能劣化，使用时间明显减少或无法进行充电。

但是，即使是使用时间明显减少的电池，通过反复充电和使用 2 ~ 5 次，有时也可恢复使用时间。

若反复充电和使用后电池的使用时间仍非常短，请认作为电池已达到了使用寿命并更换新的电池。

## 注意！

在操作和维修电动工具时，必须遵守贵国制定的安全的有关规则和标准。

### 关于 HIKOKI 牌无线电动工具的重要通知：

请确保始终使用我们指定的正版电池。如果使用我们指定以外的电池，或对电池进行拆卸和改动（例如拆卸和更换电池组件或其他内部部件），那么我们无法保证我们无线电动工具的安全性和使用性能。

## 故障排除

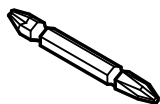
如果工具操作不正常，请使用下表中的检查步骤。如果未能解决问题，请向经销商或 HiKOKI 公司授权服务中心咨询。

现象	可能的原因	解决办法
工具无法运行	没有剩余电池电量	为电池充电
	电池没有牢固安装	按压电池直到听到咔嚓声
工具突然停止	工具过度负重	解除负担过重原因。
	电池或工具过热	让该工具和电池得到充分冷却。
钻头 - 无法安装 - 掉落	安装部分的形状不匹配	无键夹盘的夹盘直径是 2 mm 到 13 mm。使用这个范围内的钻头。
	无键夹盘的锁已经磨损	联系 HiKOKI 授权服务中心并安排将无键夹盘以旧换新。
无法拔出开关	向前 / 向后选择按钮没有按到底	根据想要的旋转方向将按钮紧压到底
螺丝头滑落或松开	钻头数量与螺丝尺寸不匹配	安装适合的钻头
	钻头已经磨损	替换为新钻头
无法顺利钻孔	电钻已经磨损	替换为新电钻
	旋转速度不合适	调整旋转速度（高 / 低）来匹配钻孔的材料
	钻头反向旋转	转换成正向旋转

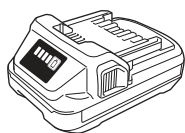
现象	可能的原因	解决办法
电池将不会充电。	电池未正确安装于充电器内。	将电池安装于充电器内，直至显示充电状态指示灯（红色）。
	充电器未插入插头。	将充电器插头插入通电插座。
	电池温度过热	从充电器中取出电池，并冷却电池。 要了解更多详情，请参阅“充电”。
	电池温度过冷	从充电器中取出电池，将电池和充电器移动至温度高于 0°C 的环境中。 要了解更多详情，请参阅“充电”。

## 选择附件

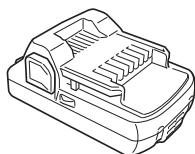
根据特定作业选择适合的附件。  
有关详细信息请联系 HiKOKI 授权服务中心。



产品编号：983006  
十字槽头螺丝刀头(2号)

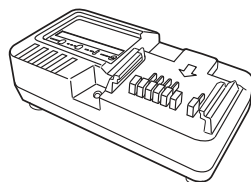


BSL1820M

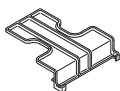


BSL1830C

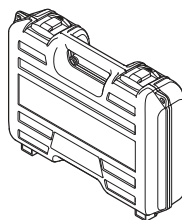
电池



UC18YKSL  
(14.4 V-18 V)  
充电器



产品编号：329897  
电池盖



产品编号：336642

## CONTENTS

GENERAL POWER TOOL SAFETY WARNINGS .....	27
CORDLESS DRIVER DRILL / IMPACT DRIVER DRILL	
SAFETY WARNINGS .....	30
ADDITIONAL SAFETY WARNINGS .....	30
CAUTION ON LITHIUM-ION BATTERY .....	31
REGARDING LITHIUM-ION BATTERY TRANSPORTATION .....	33
SYMBOLS .....	33
NAME OF PARTS.....	34
SPECIFICATIONS .....	35
STANDARD ACCESSORIES .....	36
APPLICATIONS.....	36
BATTERY REMOVAL / INSTALLATION .....	37
CHARGING .....	37
PRIOR TO OPERATION.....	40
HOW TO USE.....	40
OPERATIONAL CAUTIONS.....	48
MAINTENANCE AND INSPECTION .....	48
TROUBLESHOOTING.....	50
SELECTING ACCESSORIES.....	52

## GENERAL POWER TOOL SAFETY WARNINGS

### WARNING

**Read all safety warnings and all instructions.**

*Failure to follow the warnings and instructions may result in electric shock, fire and/or serious injury.*

**Save all warnings and instructions for future reference.**

*The term “power tool” in the warnings refers to your mains-operated (corded) power tool or battery-operated (cordless) power tool.*

#### 1) Work area safety

##### a) Keep work area clean and well lit.

*Cluttered or dark areas invite accidents.*

##### b) Do not operate power tools in explosive atmospheres, such as in the presence of flammable liquids, gases or dust.

*Power tools create sparks which may ignite the dust or fumes.*

##### c) Keep children and bystanders away while operating a power tool.

*Distractions can cause you to lose control.*

# English

## 2) Electrical safety

- a) **Power tool plugs must match the outlet.**  
**Never modify the plug in any way.**  
**Do not use any adapter plugs with earthed (grounded) power tools.**  
*Unmodified plugs and matching outlets will reduce risk of electric shock.*
- b) **Avoid body contact with earthed or grounded surfaces, such as pipes, radiators, ranges and refrigerators.**  
*There is an increased risk of electric shock if your body is earthed or grounded.*
- c) **Do not expose power tools to rain or wet conditions.**  
*Water entering a power tool will increase the risk of electric shock.*
- d) **Do not abuse the cord. Never use the cord for carrying, pulling or unplugging the power tool.**  
**Keep cord away from heat, oil, sharp edges or moving parts.**  
*Damaged or entangled cords increase the risk of electric shock.*
- e) **When operating a power tool outdoors, use an extension cord suitable for outdoor use.**  
*Use of a cord suitable for outdoor use reduces the risk of electric shock.*
- f) **If operating a power tool in a damp location is unavoidable, use a residual current device (RCD) protected supply.**  
*Use of an RCD reduces the risk of electric shock.*

## 3) Personal safety

- a) **Stay alert, watch what you are doing and use common sense when operating a power tool.**  
**Do not use a power tool while you are tired or under the influence of drugs, alcohol or medication.**  
*A moment of inattention while operating power tools may result in serious personal injury.*
- b) **Use personal protective equipment. Always wear eye protection.**  
*Protective equipment such as dust mask, non-skid safety shoes, hard hat, or hearing protection used for appropriate conditions will reduce personal injuries.*
- c) **Prevent unintentional starting. Ensure the switch is in the off position before connecting to power source and/or battery pack, picking up or carrying the tool.**  
*Carrying power tools with your finger on the switch or energising power tools that have the switch on invites accidents.*
- d) **Remove any adjusting key or wrench before turning the power tool on.**  
*A wrench or a key left attached to a rotating part of the power tool may result in personal injury.*
- e) **Do not overreach. Keep proper footing and balance at all times.**  
*This enables better control of the power tool in unexpected situations.*
- f) **Dress properly. Do not wear loose clothing or jewellery. Keep your hair, clothing and gloves away from moving parts.**  
*Loose clothes, jewellery or long hair can be caught in moving parts.*

- g) **If devices are provided for the connection of dust extraction and collection facilities, ensure these are connected and properly used.**

*Use of dust collection can reduce dust-related hazards.*

#### 4) **Power tool use and care**

- a) **Do not force the power tool. Use the correct power tool for your application.**

*The correct power tool will do the job better and safer at the rate for which it was designed.*

- b) **Do not use the power tool if the switch does not turn it on and off.**

*Any power tool that cannot be controlled with the switch is dangerous and must be repaired.*

- c) **Disconnect the plug from the power source and/or the battery pack from the power tool before making any adjustments, changing accessories, or storing power tools.**

*Such preventive safety measures reduce the risk of starting the power tool accidentally.*

- d) **Store idle power tools out of the reach of children and do not allow persons unfamiliar with the power tool or these instructions to operate the power tool.**

*Power tools are dangerous in the hands of untrained users.*

- e) **Maintain power tools. Check for misalignment or binding of moving parts, breakage of parts and any other condition that may affect the power tool's operation.**

**If damaged, have the power tool repaired before use.**

*Many accidents are caused by poorly maintained power tools.*

- f) **Keep cutting tools sharp and clean.**

*Properly maintained cutting tools with sharp cutting edges are less likely to bind and are easier to control.*

- g) **Use the power tool, accessories and tool bits etc. in accordance with these instructions, taking into account the working conditions and the work to be performed.**

*Use of the power tool for operations different from those intended could result in a hazardous situation.*

#### 5) **Battery tool use and care**

- a) **Recharge only with the charger specified by the manufacturer.**

*A charger that is suitable for one type of battery pack may create a risk of fire when used with another battery pack.*

- b) **Use power tools only with specifically designated battery packs.**

*Use of any other battery packs may create a risk of injury and fire.*

- c) **When battery pack is not in use, keep it away from other metal objects, like paper clips, coins, keys, nails, screws or other small metal objects, that can make a connection from one terminal to another.**

*Shorting the battery terminals together may cause burns or a fire.*

- d) **Under abusive conditions, liquid may be ejected from the battery; avoid contact. If contact accidentally occurs, flush with water. If liquid contacts eyes, additionally seek medical help.**

*Liquid ejected from the battery may cause irritation or burns.*

## English

### 6) Service

- a) **Have your power tool serviced by a qualified repair person using only identical replacement parts.**

*This will ensure that the safety of the power tool is maintained.*

## CAUTION

Keep children and infirm persons away.

When not in use, tools should be stored out of reach of children and infirm persons.

## CORDLESS DRIVER DRILL / IMPACT DRIVER DRILL SAFETY WARNINGS

### <DV18DD>

1. **Wear ear protectors when impact drilling.**

Exposure to noise can cause hearing loss.

### <DS18DD / DV18DD>

1. **Hold the power tool by insulated gripping surfaces, when performing an operation where the cutting accessory or fastener may contact hidden wiring.**

Cutting accessory or fasteners contacting a "live" wire may make exposed metal parts of the power tool "live" and could give the operator an electric shock.

## ADDITIONAL SAFETY WARNINGS

1. **Make sure that the area to be drilled is absolutely free of any hidden obstructions including electrical wiring, water, or gas pipes. Drilling into the aforementioned may result in electric shock or short circuit, gas leak or other hazards that can cause serious accidents or injuries.**
2. **During operation, make sure to firmly hold the tool's handle. Failure to do so may result in injury.**
3. **Secure the workpiece. A workpiece clamped with clamping devices or in a vice is held more secure than by hand.**
4. **Setting up and checking the work environment. Check if the work environment is suitable by following the precaution.**
5. **Do not allow foreign matter to enter the hole for connecting the battery.**
6. **Never disassemble the battery and charger.**
7. **Never short-circuit the battery. Shortcircuiting the battery will cause a great electric current and overheat. It results in burn or damage to the battery.**
8. **Do not dispose of the battery in fire. If the battery is burnt, it may explode.**
9. **Bring the battery to the shop from which it was purchased as soon as the post-charging battery life becomes too short for practical use. Do not dispose of the exhausted battery.**
10. **Do not insert object into the air ventilation slots of the charger. Inserting metal objects or inflammables into the charger air ventilation slots will result in electrical shock hazard or damaged charger.**

11. When mounting a bit into the keyless chuck, tighten the sleeve adequately. If the sleeve is not tight, the bit may slip or fall out, causing injury.
12. The motor may stop in the event the tool is overloaded. In this should occur, release the tool's switch and eliminate the cause of the overload.
13. Do not use the product if the tool or the battery terminals (battery mount) are deformed.  
Installing the battery could cause a short circuit that could result in smoke emission or ignition.
14. Keep the tool's terminals (battery mount) free of swarf and dust.
  - Prior to use, make sure that swarf and dust have not collected in the area of the terminals.
  - During use, try to avoid swarf or dust on the tool from falling on the battery.
  - When suspending operation or after use, do not leave the tool in an area where it may be exposed to falling swarf or dust.  
Doing so could cause a short circuit that could result in smoke emission or ignition.
15. Always charge the battery at a temperature of 0°C–40°C. A temperature of less than 0°C will result in over charging which is dangerous. The battery cannot be charged at a temperature higher than 40°C.  
The most suitable temperature for charging is that of 20°C–25°C.

## CAUTION ON LITHIUM-ION BATTERY

To extend the lifetime, the lithium-ion battery equips with the protection function to stop the output.

In the cases of 1 to 3 described below, when using this product, even if you are pulling the switch, the motor may stop. This is not the trouble but the result of protection function.

1. When the battery power remaining runs out, the motor stops.  
In such case, charge it up immediately.
2. If the tool is overloaded, the motor may stop. In this case, release the switch of tool and eliminate causes of overloading. After that, you can use it again.
3. If the battery is overheated under overload work, the battery power may stop.  
In this case, stop using the battery and let the battery cool. After that, you can use it again.

Furthermore, please heed the following warning and caution.

## WARNING

In order to prevent any battery leakage, heat generation, smoke emission, explosion and ignition beforehand, please be sure to heed the following precautions.

1. Make sure that swarf and dust do not collect on the battery.
  - During work make sure that swarf and dust do not fall on the battery.
  - Make sure that any swarf and dust falling on the power tool during work do not collect on the battery.
  - Do not store an unused battery in a location exposed to swarf and dust.
  - Before storing a battery, remove any swarf and dust that may adhere to it and do not store it together with metal parts (screws, nails, etc.).

## English

2. Do not pierce battery with a sharp object such as a nail, strike with a hammer, step on, throw or subject the battery to severe physical shock.
3. Do not use an apparently damaged or deformed battery.
4. Do not use the battery in reverse polarity.
5. Do not connect directly to an electrical outlets or car cigarette lighter sockets.
6. Do not use the battery for a purpose other than those specified.
7. If the battery charging fails to complete even when a specified recharging time has elapsed, immediately stop further recharging.
8. Do not put or subject the battery to high temperatures or high pressure such as into a microwave oven, dryer, or high pressure container.
9. Keep away from fire immediately when leakage or foul odor are detected.
10. Do not use in a location where strong static electricity generates.
11. If there is battery leakage, foul odor, heat generated, discolored or deformed, or in any way appears abnormal during use, recharging or storage, immediately remove it from the equipment or battery charger, and stop use.
12. Do not immerse the battery or allow any fluids to flow inside. Conductive liquid ingress, such as water, can cause damage resulting in fire or explosion. Store your battery in a cool, dry place, away from combustible and flammable items. Corrosive gas atmospheres must be avoided.

### CAUTION

1. If liquid leaking from the battery gets into your eyes, do not rub your eyes and wash them well with fresh clean water such as tap water and contact a doctor immediately.  
If left untreated, the liquid may cause eye-problems.
2. If liquid leaks onto your skin or clothes, wash well with clean water such as tap water immediately.  
There is a possibility that this can cause skin irritation.
3. If you find rust, foul odor, overheating, discolor, deformation, and/or other irregularities when using the battery for the first time, do not use and return it to your supplier or vendor.

### WARNING

If a conductive foreign matter enters in the terminal of lithium ion battery, the battery may be shorted, causing fire. When storing the lithium ion battery, obey surely the rules of following contents.

- Do not place conductive debris, nail and wires such as iron wire and copper wire in the storage case.
- To prevent shorting from occurring, load the battery in the tool or insert securely the battery cover for storing until the ventilator is not seen (See Fig. 1).

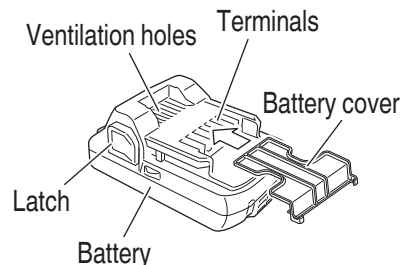


Fig. 1

## REGARDING LITHIUM-ION BATTERY TRANSPORTATION

When transporting a lithium-ion battery, please observe the following precautions.

### WARNING

Notify the transporting company that a package contains a lithium-ion battery, inform the company of its power output and follow the instructions of the transportation company when arranging transport.

- Lithium-ion batteries that exceed a power output of 100 Wh are considered to be in the freight classification of Dangerous Goods and will require special application procedures.
- For transportation abroad, you must comply with international law and the rules and regulations of the destination country.

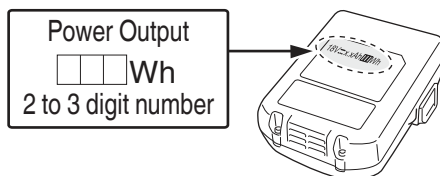





Fig. 2

## SYMBOLS

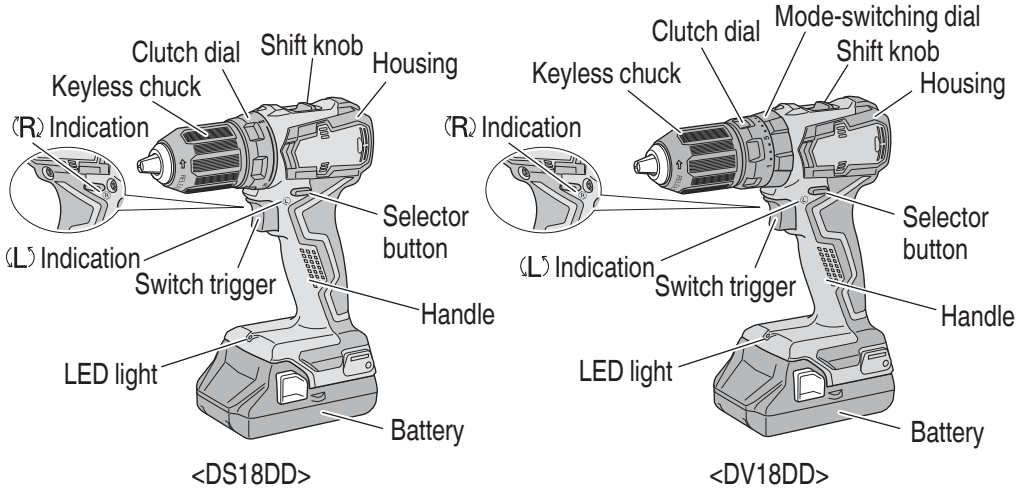
### WARNING

The following show symbols used for the machine. Be sure that you understand their meaning before use.

	To reduce the risk of injury, user must read instruction manual.	$n_0$	No-load speed
	Direct current	/min	Oscillation per minute
V	Rated voltage		Warning

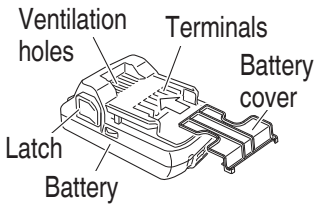
**NAME OF PARTS**

**1. POWER TOOL**

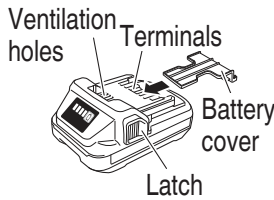


**Fig. 3**

**2. Battery**

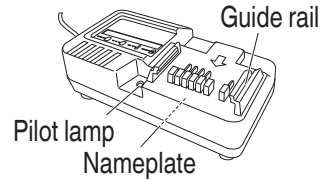


<BSL1830C>



<BSL1820M>

**3. Battery Charger**



<UC18YKSL>

**Fig. 4**

**Fig. 5**

## SPECIFICATIONS

### POWER TOOL

Model		DS18DD	DV18DD	
Voltage		18 V		
No-load speed	Low	0 – 440 /min		
	High	0 – 1700 /min		
Impact rate	Low	—	0 – 6600 /min	
	High	—	0 – 25500 /min	
Capacity	Drilling	Brick (Depth 30 mm)	—	13 mm
		Wood (Thickness 38 mm)	36 mm (Soft wood)	
		Metal (Thickness 1.6 mm)	Steel: 13 mm, Aluminum: 13 mm	
	Driving	Wood screw	6 mm (diameter) × 75 mm (length) (Requires a pilot hole)	
		Small screw	6 mm	
Drill chuck capacity		Maximum gripping diameter 2.0 – 13 mm		
Battery		BSL1830C: Li-ion 18 V (3.0 Ah 5 cells) BSL1820M: Li-ion 18 V (2.0 Ah 5 cells)		
Weight		1.2 kg (BSL1830C/BSL1820M attached)	1.3 kg (BSL1830C/BSL1820M attached)	

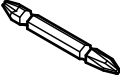

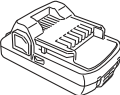



### CHARGER

Model	UC18YKSL
Charging voltage	14.4–18 V
Weight	0.35 kg

## STANDARD ACCESSORIES

In addition to the main unit (1 unit), the package contains the accessories listed in the below.

Table 1

	DS18DD		DV18DD	
	(2MGK)	(2BGK)	(2MGK)	(2BGK)
 Plus driver bit (No. 2)	1	1	1	1
 Charger (UC18YKSL)	1	1	1	1
 Battery (BSL1830C)	2	—	2	—
 Battery (BSL1820M)	—	2	—	2
 Battery cover	1	1	1	1
 Plastic case	1	1	1	1

## APPLICATIONS

### <DS18DD>

- Driving and removing of machine screws, wood screws, tapping screws, etc.
- Drilling of various metals.
- Drilling of various woods.

### <DV18DD>

- Drilling of brick and concrete block, etc.
- Driving and removing of machine screws, wood screws, tapping screws, etc.
- Drilling of various metals.
- Drilling of various woods.

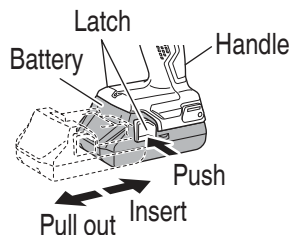
## BATTERY REMOVAL / INSTALLATION

1. Battery removal  
Hold the handle tightly and push the battery latches to remove the battery (see **Fig. 6**).

### CAUTION

**Never short-circuit the battery.**

2. Battery installation  
Insert the battery while observing its polarities (see **Fig. 6**).



**Fig. 6**

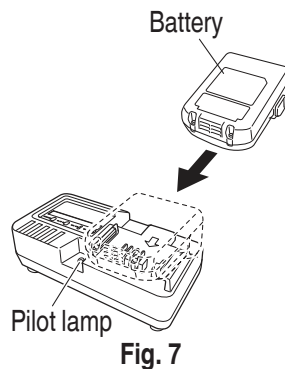
## CHARGING

Before using the power tool, charge the battery as follows.

1. Connect the charger's power cord to the receptacle.  
When connecting the plug of the charger to a receptacle, the pilot lamp will blink in red (At 1- second intervals).
2. Insert the battery into the charger.  
Firmly insert the battery into the charger as shown in **Fig. 7**.
3. Charging  
When inserting a battery in the charger, charging will commence and the pilot lamp will light continuously in red.  
When the battery becomes fully recharged, the pilot lamp will blink in red. (At 1-second intervals) (See **Table 2 on page 38**)






### ● Pilot lamp indication

The indications of the pilot lamp will be as shown in **Table 2 on page 38**, according to the condition of the charger or the battery.



**Fig. 7**

**Table 2**

Indications of the pilot lamp				
Pilot lamp (red)	Before charging	Blinks	Lights for 0.5 seconds. Does not light for 0.5 seconds. (off for 0.5 seconds) 	/
	While charging	Lights	Lights continuously 	
	Charging complete	Blinks	Lights for 0.5 seconds. Does not light for 0.5 seconds. (off for 0.5 seconds) 	
	Overheat standby	Blinks	Lights for 1 second. Does not light for 0.5 seconds. (off for 0.5 seconds) 	Battery overheated. Unable to charge. (Charging will commence when battery cools)
	Charging impossible	Flickers	Lights for 0.1 seconds. Does not light for 0.1 seconds. (off for 0.1 seconds) 	Malfunction in the battery or the charger

- Regarding the temperatures and charging time of the battery.  
The temperatures and charging time will become as shown in **Table 3**.

**Table 3**

Battery		Charger	UC18YKSL
Charging voltage		V	14.4–18
Weight		kg	0.35
Temperatures at which the battery can be recharged			0°C–50°C
Charging time for battery capacity, approx. (At 20°C)			
1.5 Ah		min.	40
2.0 Ah		min.	60
2.5 Ah		min.	75
3.0 Ah		min.	90
4.0 Ah		min.	120
5.0 Ah		min.	150
6.0 Ah		min.	180
8.0 Ah		min.	240
Number of battery cells			4–10

**NOTE**

The recharging time may vary according to temperature and power source voltage.

**CAUTION**

**When the battery charger has been continuously used, the battery charger will be heated, thus constituting the cause of the failures. Once the charging has been completed, give 15 minutes rest until the next charging.**

4. Disconnect the charger's power cord from the receptacle.
5. Hold the charger firmly and pull out the battery.

**NOTE**

Be sure to pull out the battery from the charger after use, and then keep it.

**Regarding electric discharge in case of new batteries, etc.**

As the internal chemical substance of new batteries and batteries that have not been used for an extended period is not activated, the electric discharge might be low when using them the first and second time. This is a temporary phenomenon, and normal time required for recharging will be restored by recharging the batteries 2 – 3 times.

**How to make the batteries perform longer.**

- (1) Recharge the batteries before they become completely exhausted.  
When you feel that the power of the tool becomes weaker, stop using the tool and recharge its battery. If you continue to use the tool and exhaust the electric current, the battery may be damaged and its life will become shorter.
- (2) Avoid recharging at high temperatures.  
A rechargeable battery will be hot immediately after use. If such a battery is recharged immediately after use, its internal chemical substance will deteriorate, and the battery life will be shortened. Leave the battery and recharge it after it has cooled for a while.

**CAUTION**

- **If the battery is charged while it is heated because it has been left for a long time in a location subject to direct sunlight or because the battery has just been used, the pilot lamp of the charger lights for 1 second, does not light for 0.5 seconds (off for 0.5 seconds). In such a case, first let the battery cool, then start charging.**
- **When the pilot lamp flickers (at 0.2-second intervals), check for and take out any foreign objects in the charger's battery connector. If there are no foreign objects, it is probable that the battery or charger is malfunctioning. Take it to your authorized Service Center.**
- **Since the built-in micro computer takes about 3 seconds to confirm that the battery being charged with charger is taken out, wait for a minimum of 3 seconds before reinserting it to continue charging. If the battery is reinserted within 3 seconds, the battery may not be properly charged.**
- **If the pilot lamp does not blink in red (every second) even though the charger cord is connected to the power, it indicates that the protection circuit of the charger may be activated.**

**Remove the cord or plug from the power and then connect it again after 30 seconds or so. If this does not cause the pilot lamp to blink in red (every second), please take the charger to the HiKOKI Authorized Service Center.**

## PRIOR TO OPERATION

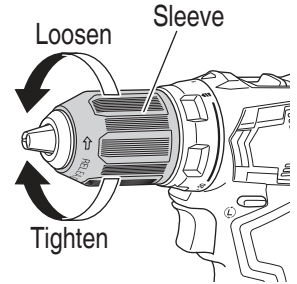
Check the work area to make sure that it is clear of debris and clutter.  
Clear the area of unnecessary personnel. Ensure that lighting and ventilation is adequate.

## HOW TO USE

1. Mounting and dismounting of the bit

(1) Mounting the bit

Loosen the sleeve by turning it toward the left (in the counterclockwise direction as viewed from the front) to open the clip on the keyless chuck. After inserting a driver bit, etc., into the keyless drill chuck, and tighten the sleeve by turning it toward the right (in the clockwise direction as viewed from the front). (See **Fig. 8**)



**Fig. 8**

### CAUTION

**When mounting a bit into the keyless chuck, tighten firmly. If the sleeve is not tight, the bit may slip or fall out, causing injury.**

### NOTE

If the sleeve becomes loose during operation, tighten it further.  
The tightening force becomes stronger when the sleeve is tightened.

(2) Dismounting the bit

Loosen the sleeve by turning it toward the left (in the counterclockwise direction as viewed from the front), and then take out the bit etc. (See **Fig. 8**)

### NOTE

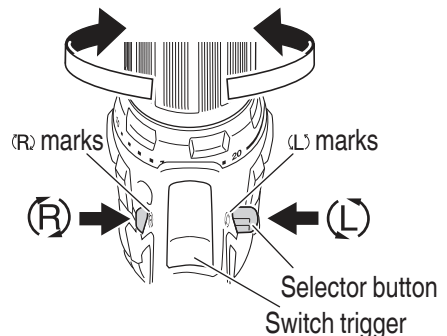
Loosening stuck or hard to move sleeves.  
Grasp the bit installed in the keyless chuck, in a vise or similar tool.  
Set the clutch dial position to "1-11" and turn on the switch. The motor then starts.  
Finally, rotate the sleeve to the left, and it will loosen.

2. Confirm that the battery is mounted correctly.

3. Check the rotational direction

The bit rotates clockwise (viewed from the rear side) by pushing the R-side of the selector button.

The L-side of the selector button is pushed to turn the bit counterclockwise. (See **Fig. 9**) (The (L) and (R) marks are provided on the body.)



**Fig. 9**

### CAUTION

**The selector button can not be switched while the power tool is turning. To switch the selector button, stop the power tool, then set the selector button.**

4. Change rotation speed  
Operate the shift knob to change the rotational speed. Move the shift knob in the direction of the arrow (See **Figs. 10** and **11**).  
When the shift knob is set to “LOW”, the drill rotates at a low speed. When set to “HIGH”, the drill rotates at a high speed.

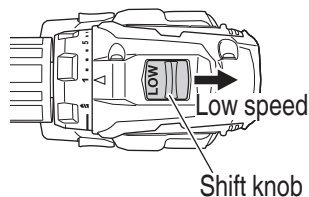


Fig. 10

## CAUTION

- When changing the rotational speed with the shift knob, confirm that the switch is off. Changing the speed while the motor is rotating will damage the gears.
- When a large force is required for operation (operations indicated in the following chart) set the shift knob to “LOW”. If “HIGH” is set and the unit is used, it may cause the motor to burn out or malfunction prematurely.

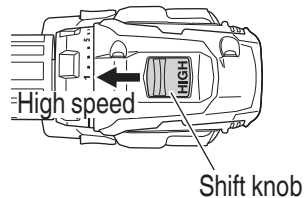




Fig. 11

5. The scope and suggestions for uses  
The usable scope for various types of work based on the mechanical structure of this unit is shown in **Table 4**.

Table 4


Work		Dial position	Suggestions
Drilling	Brick (DV18DD)	<b>T</b>	Use for drilling purpose.
	Wood		
	Steel		
	Aluminum		
Screw tightening	Small screw	1 – 20	Use the bit or socket matching the screw diameter.
	Wood screw	1 – 	Use after drilling a pilot hole.

# English

## 6. <DS18DD>

Confirm the clutch dial position (See Fig. 12)

The tightening torque of this unit can be adjusted according to the clutch dial position, at which the clutch dial is set.

- (1) When using this unit as a screwdriver, line up the one of the numbers “1, 5, 10 ... 20” on the clutch dial, or the dots, with the triangle mark on the outer body.
- (2) When using this unit as a drill, align the clutch dial drill mark “” with the triangle mark on the outer body.

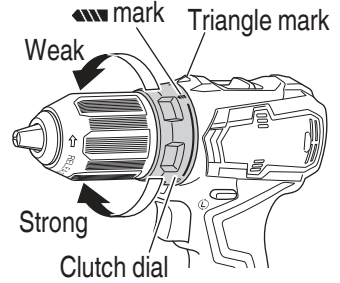



Fig. 12

## CAUTION

- The clutch dial cannot be set between the numbers “1, 5, 10 ... 20” or the dot.
- Do not use with the clutch dial set at the line between the number “20” and the drill mark “”. Doing so may cause damage (See Fig. 13).

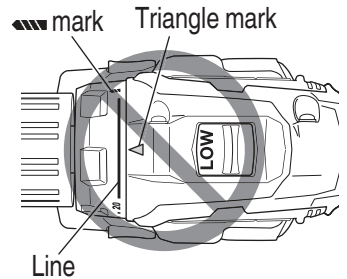




Fig. 13

## 7. <DV18DD>

Confirm the mode-switching dial and clutch dial position (see Figs. 14, 15 and 16)

The three modes of screwdriver, drill and impact drill can be switched by the position of the mode-switching dial in this unit.

- (1) When using this unit as a screwdriver, align the mode-switching dial screw-tightening mark “” with the triangle mark on the outer body, and line up the one of the numbers “1, 5, 10 ... 20” on the clutch dial, or the dots, with the triangle mark on the outer body (see Figs. 14 and 15).
- (2) When using this unit as a drill, align the mode-switching dial drill mark “” with the triangle mark on the outer body.
- (3) When using this unit as an impact drill, align the mode-switching dial hammer mark “**T**” with the triangle mark on the outer body (see Fig. 16).

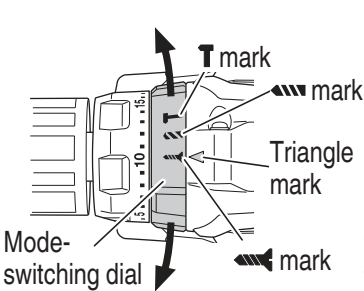


Fig. 14

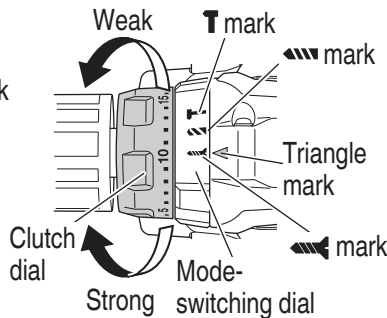


Fig. 15

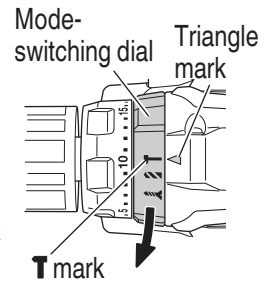




Fig. 16

**CAUTION**


- Always make sure the motor is stopped when using the mode-switching dial. If it is difficult to switch over, slightly pull the switch to allow a little rotation and then attempt to switch the mode.
- Make sure the mode-switching dial is fully switched over. Using the tool with the switch positioned midway can result in malfunction.
- Prior to use, make sure that the mode-switching dial is in the proper position. Failure to do so can not only result in reduced efficiency, but may also damage the screw or drill.
- The clutch dial cannot be set between the numbers “1, 5, 10 ... 20” or the dot.
- Always use this unit with clockwise rotation, when using it as impact drill (See Fig. 16).

8. Rotation to Impact changeover (DV18DD)

The “Rotation (Rotation only)” and “Impact (Impact + Rotation)” can be switched by aligning the drill mark “” or the hammer mark “” with the triangle mark on the outer body.

- To make holes in the metal, wood or plastic, switch to “Rotation (Rotation only)”.
- To make holes in bricks or concrete blocks, switch to “Impact (Impact + Rotation)”.

**CAUTION**

- Do not use the Cordless impact drill in the “Impact” setting if the material can be bored by rotation only. Such action will not only reduce drill efficiency, but may also damage the drill tip.
- When tightening/loosening screws or drilling holes in metal/wood do not use the hammer mark “” (Impact + Rotation). Doing so can not only result in reduced efficiency, but may also damage the screw or drill.
- For the “Rotation (Rotation Only)” and “Impact (Impact + Rotation)” modes, no adjustment of the clutch dial is required.

9. Tightening torque adjustment

(1) Tightening torque

Tightening torque should correspond in its intensity to the screw diameter. When too strong torque is used, the screw head may be broken or be injured. Be sure to adjust the clutch dial position according to the screw diameter.

(2) Tightening torque indication (See Fig. 17)

The tightening torque differs depending on the type of screw and the material being tightened. The unit indicates the tightening torque with the numbers “1, 5, 10 ... 20” on the clutch dial, and a dots. The tightening torque at position “1” is the weakest and the torque is strongest at the highest number.

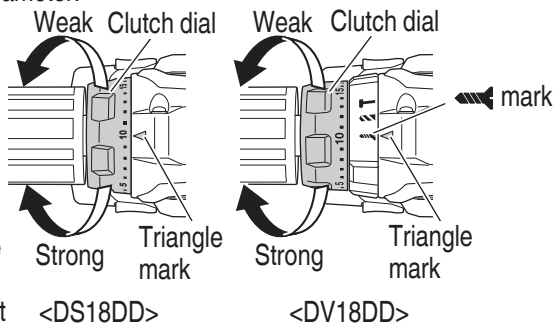


Fig. 17

## English

- (3) Adjusting the tightening torque (See **Fig. 17 on page 43**)  
Rotate the clutch dial and line up the numbers “1, 5, 10 ... 20” on the clutch dial, or the dots, with the triangle mark on the outer body. Adjust the clutch dial in the weak or the strong torque direction according to the torque you need.

**Table 5** Tightening torque

Clutch dial position	Tightening torque
1	Approx. 0.6 N-m
5	Approx. 1.3 N-m
10	Approx. 2.2 N-m
15	Approx. 3.1 N-m
20	Approx. 4.0 N-m

10. Switch operation
- When the switch trigger is depressed, the tool rotates. When the trigger is released, the tool stops.
  - When releasing the trigger of the switch, the brake will be applied for immediate stopping.
  - The rotational speed of the drill can be controlled by varying the amount that the switch trigger is pulled. Speed is low when the switch trigger is pulled slightly and increases as the switch trigger is pulled more.
11. For drilling into brick (DV18DD)  
Excessive pressing force never increases drilling speed. It will not only damage the drill tip or reduce working efficiency, but could also shorten the service life of drill bit. Operate the impact driver drill within 10 – 20 kg pressing force while drilling into brick.

### CAUTION

- **The motor rotation may be locked to cease while the unit is used as drill. While operating the power tool, take care not to lock the motor.**
- **If the motor is locked, immediately turn the power off. If the motor is locked for a while, the motor or battery may be burnt.**
- **Do not tighten too strongly as the screw heads will be damaged.**

12. How to select the rotational speed



### CAUTION

- **The selection examples shown in Table 6 on page 45 should be considered as general standard. As different types of tightening screws and different materials to be tightened are used in actual works proper adjustments are naturally necessary.**
- **When using the power tool with a machine screw at HIGH (high speed), a screw may damage or a bit may loose due to the tightning torque is too strong. Use the power tool at LOW (low speed) when using a machine screw.**

### NOTE

The use of the battery in a cold condition (below 0 degree Centigrade) can sometimes result in the weakened tightening torque and reduced amount of work. This, however, is a temporary phenomenon, and returns to normal when the battery warms up.

Table 6

Work		Dial Position	Rotating speed selection (Position of the shift knob)	
			LOW (Low speed)	HIGH (High speed)
Drilling	Wood		For 36 mm or smaller diameters.	For 18 mm or smaller diameters.
	Metal		—	For drilling with a metal working drill bit.
Screw tightening	Small screw	1 – 20	For 6 mm or smaller nominal diameter screws.	For 6 mm or smaller nominal diameter screws.
	Wood screw	1 – 		For 4.1 mm or smaller nominal diameter screws.

13. Remaining battery indicator  
You can check the battery's remaining capacity by pressing the remaining battery indicator switch to light the indicator lamp.

(Fig. 18, Table 7 on page 46)

The indicator will shut off approximately 3 seconds after the remaining battery indicator switch is pressed.

It is best to use the remaining battery indicator as a guide since there are slight differences such as ambient temperature and the condition of the battery.

Also, the remaining battery indicator may vary from those equipped to a tool or charger.

Remaining battery indicator lamp      Remaining battery indicator switch

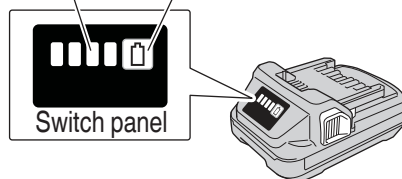





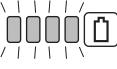



Fig. 18

Table 7

State of lamp	Battery Remaining Power
	Lights ; The battery remaining power is over 75%
	Lights ; The battery remaining power is 50% – 75%.
	Lights ; The battery remaining power is 25% – 50%.
	Lights ; The battery remaining power is less than 25%
	Blinks ; The battery remaining power is nearly empty. Recharge the battery soonest possible.
	Blinks ; Output suspended due to high temperature. Remove the battery from the tool and allow it to fully cool down.
	Blinks ; Output suspended due to failure or malfunction. The problem may be the battery so please contact your dealer.

As the remaining battery indicator shows somewhat differently depending on ambient temperature and battery characteristics, read it as a reference.

**NOTE**

Do not give a strong shock to the display panel or break it. It may lead to a trouble.

14. How to use the LED light

While the switch is pulled, the LED light will automatically light up the tip portion of the tool. (Fig. 19)

The LED light will automatically turn off 10 seconds after the switch is released. The LED light also functions as a warning signal that lights up during use. For details, see “16. LED light warning signals”.

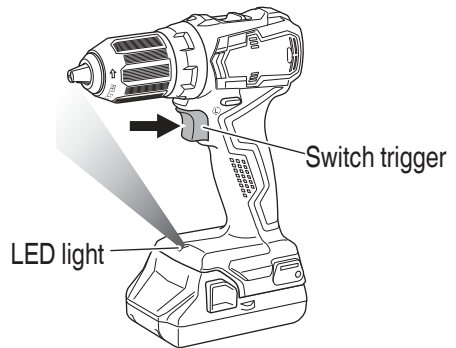


Fig. 19

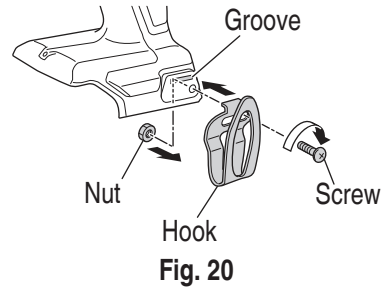
**CAUTION**

- Do not expose directly your eye to the light by looking into the light. If your eye is continuously exposed to the light, your eye will be hurt.

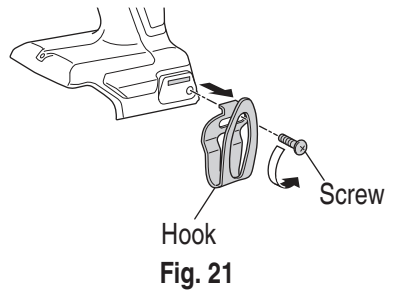
15. Using the hook (sold separately)  
The hook is used to hang up the power tool to your waist belt while working.

## CAUTION

- When using the hook, hang up the power tool firmly not to drop accidentally. If the power tool is dropped, it may lead to an accident.
  - When carrying the power tool with hooked to your waist belt, do not fit any bit to the tip of power tool. If the sharp bit such as drill is fitted to the power tool when carrying it with hooked to your waist belt, you will be injured.
  - Install securely the hook. Unless the hook is securely installed, it may cause an injury while using.
- (1) Placing the hook and tightening the screws.  
Install securely the hook in the groove of power tool and tighten the screws to fix the hook firmly (Fig. 20).



- (2) Removing the hook.  
Remove the screws fixing the hook with Philips screw driver. (Fig. 21)



16. LED light warning signals (Fig. 22)  
This product features functions that are designed to protect the tool itself as well as the battery. While the switch is pulled, if any of the safeguard functions activate during operation, the LED light will blink as described in **Table 8 on page 48**. When any of the safeguard functions are triggered, immediately remove your finger from the switch and follow the instructions described under corrective action.

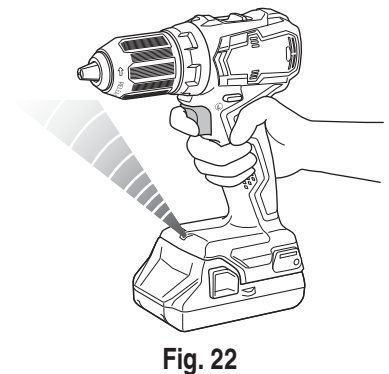




Table 8

Safeguard Function	LED Light Display	Corrective Action
Overburden Protection	On 0.1 second/off 0.5 second 	If the operating with the shift knob set on HIGH, adjust to LOW and continue operation. Remove the cause of the overburdening.
Temperature Protection	On 0.3 second/off 0.3 second 	Allow the tool and battery to thoroughly cool.

## OPERATIONAL CAUTIONS

Resting the unit after continuous work

- (1) The power tool is equipped with a temperature protection circuit to protect the motor. Continuous bolt-tightening work may cause the temperature of the unit to rise, activating the temperature protection circuit and automatically stopping operation. If this happens, allow the power tool to cool before resuming use.
- (2) After use for continuous tightening wood screw works, rest the unit for 15 minutes or so when replacing the battery. The temperature of the motor, switch, etc., will rise if the work is started again immediately after battery replacement, eventually resulting in burnout.

## MAINTENANCE AND INSPECTION

1. Inspecting the tool  
 Since use of a dull tool will degrade efficiency and cause possible motor malfunction, sharpen or replace the tool as soon as abrasion is noted.
2. Inspecting the mounting screws  
 Regularly inspect all mounting screws and ensure that they are properly tightened. Should any of the screws be loose, retighten them immediately. Failure to do so could result in serious hazard.
3. Maintenance of the motor  
 The motor unit winding is the very “heart” of the power tool. Exercise due care to ensure the winding does not become damaged and/or wet with oil or water.
4. Inspection of terminals (tool and battery)  
 Check to make sure that swarf and dust have not collected on the terminals. On occasion check prior, during and after operation.

### CAUTION

**Remove any swarf or dust which may have collected on the terminals. Failure to do so may result in malfunction.**

5. **Cleaning of the outside**  
When the power tool is stained, wipe with a soft dry cloth or a cloth moistened with soapy water. Do not use chloric solvents, gasoline or paint thinner, for they melt plastics.
6. **Storage**  
Store the power tool in a place in which the temperature is less than 40°C and out of reach of children.

**NOTE****Storing Lithium-ion Batteries**

Make sure the batteries have been fully charged before storing them.

Prolonged storage (3 months or more) of batteries with a low charge may result in performance deterioration, significantly reducing battery usage time or rendering the batteries incapable of holding a charge.

However, significantly reduced battery usage time may be recovered by repeatedly charging and using the batteries two to five times.

If the battery usage time is extremely short despite repeated charging and use, consider the batteries dead and purchase new batteries.

**CAUTION**

**In the operation and maintenance of power tools, the safety regulations and standards prescribed in each country must be observed.**

**Important notice on the batteries for the HiKOKI cordless power tools**

Please always use one of our designated genuine batteries. We cannot guarantee the safety and performance of our cordless power tool when used with batteries other than these designated by us, or when the battery is disassembled and modified (such as disassembly and replacement of cells or other internal parts).

## TROUBLESHOOTING

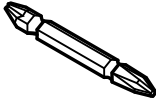
Use the inspections in the table below if the tool does not operate normally. If this does not remedy the problem, consult your dealer or the HiKOKI Authorized Service Center.

Symptom	Possible cause	Remedy
Tool doesn't run	No remaining battery power	Charge the battery.
	Battery isn't securely attached.	Push in the battery until a click is heard.
Tool suddenly stopped	Tool was overburdened	Remove the cause of the overburdening.
	Battery or tool overheated	Allow the tool and battery to thoroughly cool.
Tool bits - can't be attached - fall off	The shape of the attachment portion doesn't match	The chucking diameter of the keyless chuck is 2 mm to 13 mm. Use a bit that falls within the stated range.
	The lock of the keyless chuck is worn	Contact a HiKOKI Authorized Service Center and arrange to have the old keyless chuck replaced with a new one.
Switch can't be pulled	Forward/reverse selector button is positioned halfway	Press the button firmly into position for the desired direction of rotation.
Screw head slips or comes loose.	Bit number doesn't match with the screw size	Install a suitable bit.
	The bit is worn	Replace with a new bit.
Holes can't be smoothly drilled.	The drill is worn	Replace with a new drill.
	Rotation speed isn't appropriate	Adjust the rotation speed (HIGH/LOW) to match the material to be drilled.
	The drill is rotating in reverse	Switch to forward rotation.

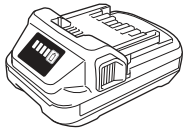
Symptom	Possible cause	Remedy
Battery will not charged.	Battery not installed into charger properly.	Insert battery into charger until charge status lamp (red) appears.
	Charger not plugged in.	Plug charger into a working receptacle.
	Battery temperature too hot	Remove battery from charger, cool battery. For more detail, refer to "Charging".
	Battery temperature too cold	Remove battery from charger, move battery and charger to a surrounding air temperature of above 0°C. For more detail, refer to "Charging".

## SELECTING ACCESSORIES

Select accessories that are suited to a specific task.  
For details contact HiKOKI Authorized Service Center.

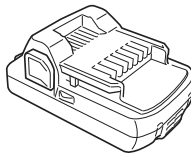


Part Number: 983006  
Plus driver bit (No.2)

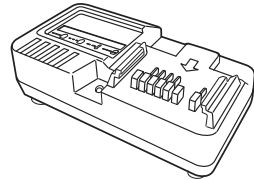


BSL1820M

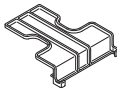
Battery



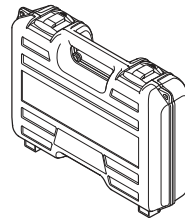
BSL1830C



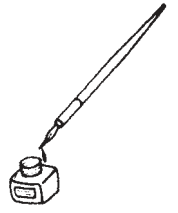
UC18YKSL  
(14.4 V - 18 V)  
Charger

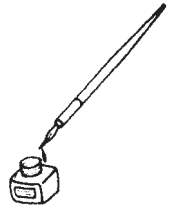


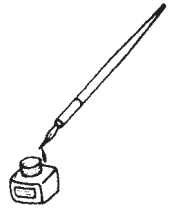
Part Number: 329897  
Battery cover



Part Number: 336642







服务中心  
高壹工机商业(上海)有限公司  
上海市闵行区浦江工业园区三鲁路3585号7幢3楼

制造商  
广东高壹工机有限公司  
广东省广州市番禺区化龙镇工业路富裕围工业村

**Koki Holdings Co., Ltd.**

209  
编号: C99738622 G  
发行日期: 2022年 9月  
中国印刷