

Hisense

LASER TV 4K

Model 120L5H



## Quick Setup Guide

Before using the Laser TV, please read this guide carefully and keep it for future reference.

Disclaimer: This Quick Setup Guide is intended as a general guideline to help you set up your Laser TV. Images throughout this document are for illustrative purposes only and may differ from the actual product.

© 2023 Hisense Company Ltd. All Rights Reserved.

All material in this Quick Setup Guide is the property of Hisense Company Ltd. and its subsidiaries, and is protected under US, CANADA, MEXICO and International copyright and/or other intellectual property laws. Reproduction or transmission of the materials, in whole or in part, in any manner, electronic, print, or otherwise, without the prior written consent of Hisense Company Ltd. is a violation of Hisense Company Ltd. rights under the aforementioned laws.

No part of this publication may be stored, reproduced, transmitted or distributed, in whole or in part, in any manner, electronic or otherwise, whether or not for a charge or other or no consideration, without the prior written permission of Hisense Company Ltd.

Requests for permission to store, reproduce, transmit or distribute materials may be made to one of the following addresses:

**U.S.A.** Hisense USA Corporation  
105 Satellite BLVD Suite I, Suwanee, GA 30024

**MEXICO**

**IMPORTER:**

Hisense Mexico S. de R.L. de C.V.  
Blvd. Miguel de Cervantes Saavedra No 301  
Torre Norte Piso 2, Col. Ampliación Granada  
Miguel Hidalgo, Ciudad de México, C.P. 11520  
RFC: HME1105121Y3  
TEL: (52) (55) 5531-3515

**CANADA** Hisense Canada Co., Ltd  
2283 Argentia Road, Unit 16  
Mississauga, ON, Canada  
L5N 5Z2

Hisense, and any and all other Hisense product names, logo's, slogans or marks are registered trademarks of Hisense Company Ltd. and its subsidiaries. All other trademarks are the property of their respective holders.

Congratulations on the purchase of your new Laser TV! This Quick Setup Guide will walk you through a few easy steps to set up your Laser TV.

## Table of Contents

Register Your Laser TV!	2
Important Safety Information	3
Packaged Contents	5
Laser TV Diagram	6
STEP 1. Mount the Screen	7
STEP 2. Set up the Laser TV	7
STEP 3. Adjust the Display Image and the Screen	10
STEP 4. Use Your Remote	14
STEP 5. Proceed through the Screen Setup Menu	16
Begin to Enjoy Your Laser TV	17
Maintenance & Quick Problem-Solving Tips	18
Product Specifications	21
Certification and Compliance	22

For detailed instructions, please refer to the E-Manual.

## Register Your Laser TV!

Because we value your business, we want to keep you in the know of 'all things Hisense'. Using your mobile phone, scan the Registration page QR code to register your Laser TV. Depending on the make and model of your phone, you may need to download a QR code scanning app.

U.S.



<http://www.hisense-usa.com/support/register>

Mexico



<https://hisense.com.mx/support/register>

Canada



<http://www.hisense-canada.com/support/productReg.asp>

## Important Safety Information



### SAFETY WARNINGS

**Do not look directly at the lens when this device is on!**

- This product comes with a laser module. Do not tear or modify this device in any manner; otherwise, it may result in personal injury.

RG1

IEC 62471-5: 2015

$\lambda = 455\pm 6\text{nm}$

Wavelength 455±6nm

CLASS 1 LASER PRODUCT

IEC 60825-1: 2014

Caution—use of controls or adjustments or performance of procedures other than those specified herein may result in hazardous radiation exposure.

The Device Complies with 21 CFR 1040.10 and 1040.11 except for conformance as a Risk Group 2 LIP as defined in IEC 62471-5: Ed.1.0. For more information see Laser Notice No.57, dated May 8, 2019.

**CLASS 1 LASER PRODUCT**

**RG1**

IEC 60825-1 : 2014

The Device Complies with 21 CFR 1040.10 and 1040.11 except for conformance as a Risk Group 1 LIP as defined in IEC 62471-5:Ed.1.0. For more information see Laser Notice NO.57, dated May 8, 2019.

**LASER**

**1**

RG1

**CLASS 1 LASER PRODUCT**  
**APPAREIL À LASER DE CLASSE 1**

IEC60825-1: 2014 & CAN/CSA-E60825-1:15

- If this device requires a repair, please wear laser eye protection with an optical density OD that is 4 or higher and has a wave length of 445-465 nm.
- Do not place any water-containing vessel on this device, such as cosmetics or liquid medicine.
- If any object or water enters this device, please unplug this device and contact the service staff of Hisense.
- Do not place any exposed fire source (e.g. burning candle) on this device. Keep away from high temperature and heat.
- Do not expose the battery to direct sunlight or candle light.
- Keep air vents on both sides clear from any objects to prevent the device from overheating inside.
- To avoid a short circuit, product damage or electric shock, do not use any sharp object or metal to touch the ports or other openings on the Laser TV.
- If this device has been in a warm environment, allow any built-up condensation to evaporate first BEFORE you switch the device on.
- Do not allow a child to stand on or climb up this device.
- Do NOT place any object above or in front of the lens because the laser light could cause the object to become flammable.
- Clean the lens periodically with a clean cloth and make sure the Laser TV is turned off before you start.

## **Low Blue light Content**

- The long-term exposure to blue light may damage your eyes, in particular the retina, causing visual fatigue or eye strain. Children are particularly vulnerable to excessive blue light and the damage to them is irreversible. The product can decrease blue light ratio to reduce blue light hazard.

## **Health recommendations**

- Avoid long time continuous use product, ensure adequate break time.
- Looking at distant objects or exercises for the eye after use product.

## Packaged Contents

- Laser TV
- 1 Remote control
- 2 AAA or AA batteries
- 2 pairs of gloves for handling the Laser TV
- 1 Power Cord
- C-shaped Block Installing Instruction
- 1 Audio Out Cable
- Hisense 4K Laser TV Quick Setup Guide
- Important Safety Information & Warranty Card
- Cleaning kit for the lens
- 2 C-shaped blocks

### NOTE:

- The accessories may be different from the list above due to different models, countries/regions. Please refer to the actual accessory bag.
- Screen is not included.

# Laser TV Diagram

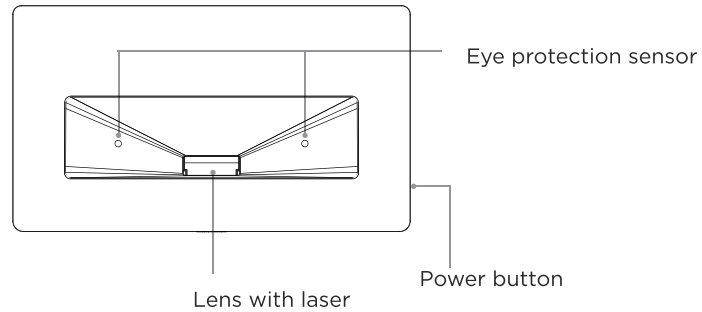
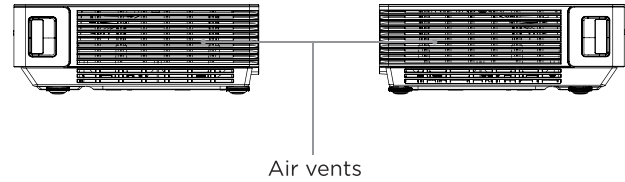
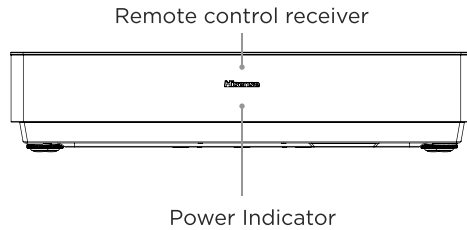

We strongly recommend that two people handle this device when moving it from one place to another. Be sure to protect the lens when you handle this device.

## STEP 1 Mount the Screen

If you purchased a screen from Hisense to include with your Laser TV, then refer to the Screen Installation Guide that's included in the package.

## STEP 2 Set up the Laser TV

To begin setting up the Laser TV, we strongly recommend that TWO people move it from one place to another because of the weight. Be sure to protect the lens when you handle this device.

1. Now, to get started, we recommend that you connect all cables to the ports on the back of the Laser TV before you position it. (Audio, video, Ethernet cables and external devices are not included.)
2. Position the Laser TV so it is parallel with the screen surface.
3. Plug the power cord into a wall outlet.
4. Press the POWER button to turn on the Laser TV.

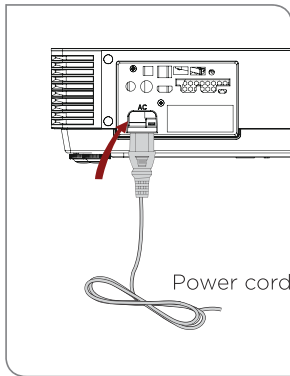

**WARNING:** Insufficient ventilation space will cause this device to overheat or become damaged.

- Do not block the air vents or place any object on this device.
- Do not place this device in any narrow, enclosed or poorly ventilated space.

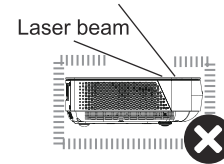

At a minimum, leave the amount of space shown in the diagram below for this device to have proper ventilation.

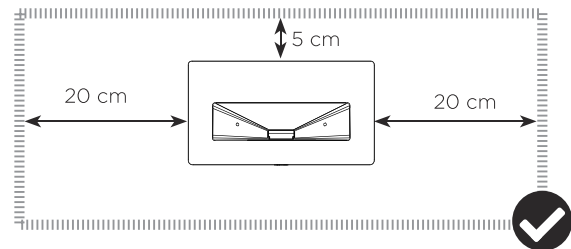

## Ports to connect certain cables to

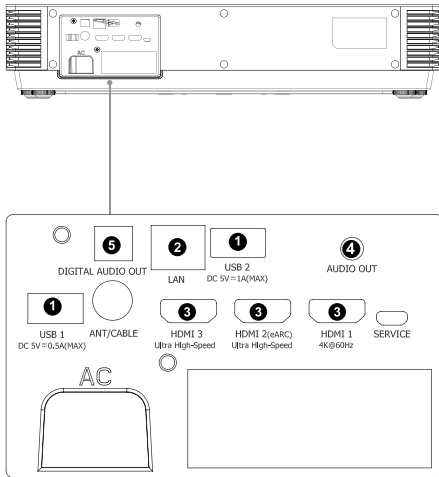

- 1  USB devices for browsing photos, music and movies. This unit only recognizes USB Memory Sticks.

### NOTE:

- When connecting a hard disk or a USB hub, always connect the mains adapter of the connected device to the power supply. Exceeding a total current consumption may result in damage. The USB2.0 device maximum current consumption is 500mA. The USB3.0 device maximum current consumption is 1A.
- If the impulse current for an individual non-standard high-capacity mobile hard disk is greater than or equal to 1A, it may cause the Laser TV to reboot or lock.
- The USB port supports a voltage of 5V.

- 2 Ethernet (you will need a router for Internet connectivity)

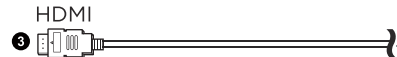
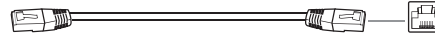

### External AV devices

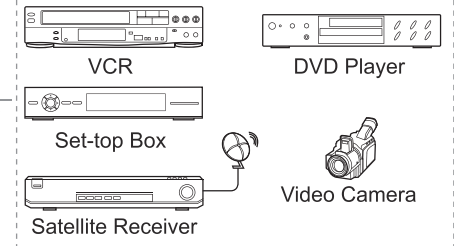

Check to ensure that you have selected the right cables for the ports and that they are connected securely. Loose connections can affect the quality of the picture image and color.

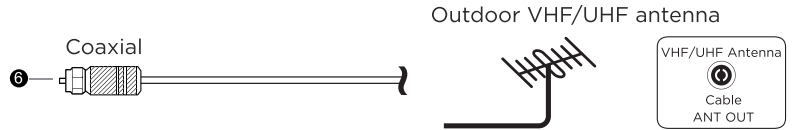
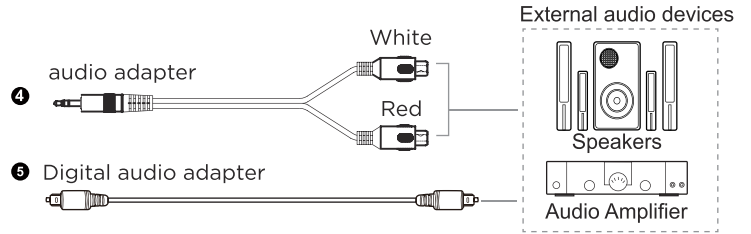
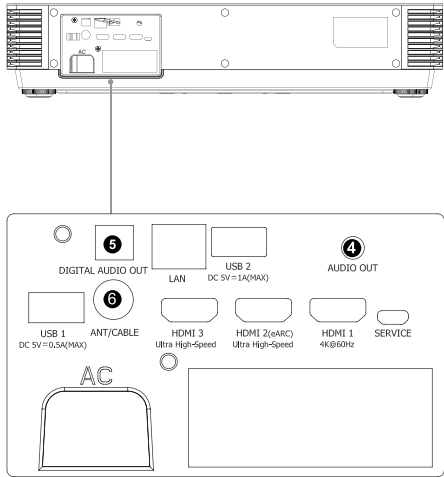

### STEP 3 Adjust the Display Image and the Screen

Follow the steps in the order shown below, only if they apply to your situation.

Note: Before adjusting, fold the wall-mount bracket wands so that screen is vertically level. Rotate feet from an overlooking view, but do not look directly at the lens when this device is on because the laser light may damage your eyes.

#### PARALLEL THE BOTTOM OF THE IMAGE WITH THE SCREEN

If the bottom of the image is lower on the left and higher on the right, rotate the device counterclockwise.

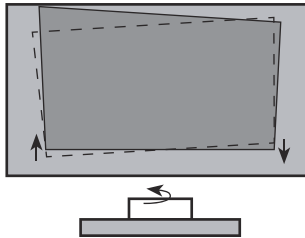

If the bottom of the image is lower on the right and higher on the left, rotate the device clockwise.

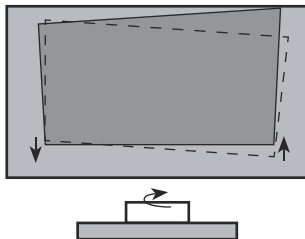

#### FIT THE BOTTOM OF THE IMAGE TO THE SCREEN

- If the image shifts to the left side, then move the Laser TV to the right.

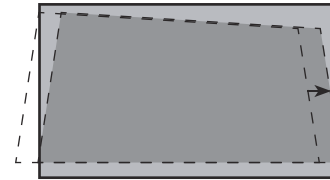

If the image shifts to the right side, then move the Laser TV to the left.

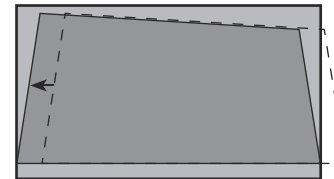

- If the bottom of the image is wider than the screen, then move the Laser TV closer to the screen.

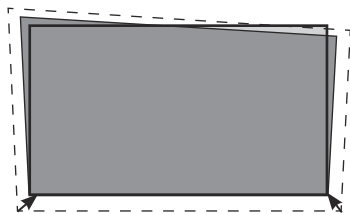

If the bottom of the image is narrower than the screen, then move the Laser TV farther from the screen.

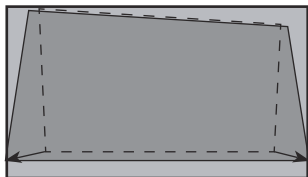

NOTE: Make sure the bottom of the image always stays parallel with the screen. If not, rotate the Laser TV following previous instructions.

## ADJUST THE UPPER-RIGHT CORNER OF THE IMAGE

1. If the top of the image is lower on the left and higher on the right, then use the wrench to rotate the front-right foot and the back-right foot clockwise to the same height.

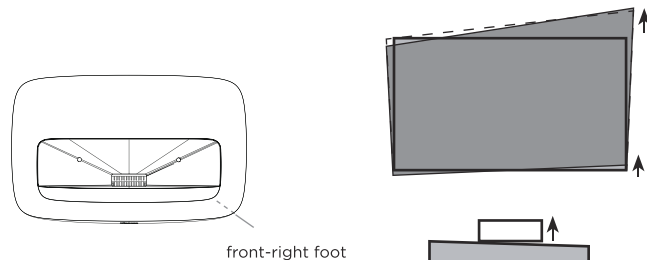

2. Now, rotate the Laser TV counterclockwise so that the bottom of the image is parallel with the screen.

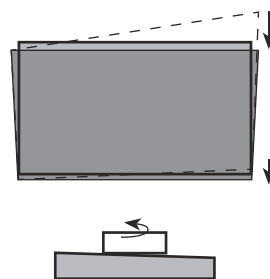

3. Repeat the steps above until the top of the image is parallel with the screen.

4. If the upper-right corner is inside the screen after adjusting, use the wrench to rotate the front-right foot and the back-right foot counterclockwise to the same height, and rotate the Laser TV clockwise, to make the image parallel with the screen.

#### ADJUST THE UPPER-LEFT CORNER OF THE IMAGE

1. If the top of the image is higher on the left and lower on the right, then use the wrench to rotate the front-left foot and the back-left foot of the Laser TV clockwise to the same height.

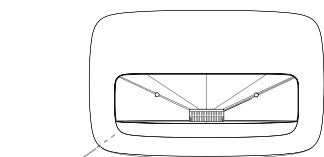

front-left foot

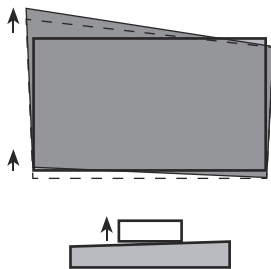

2. Now, rotate the Laser TV clockwise so that the bottom of the image is parallel with the screen.

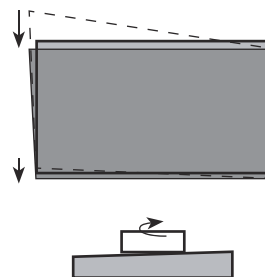

3. Repeat the steps above until the top of the image is parallel with the screen.
4. If the upper-left corner is inside the screen after adjusting, use the wrench to rotate the front-left foot and the back-left foot counterclockwise to the same height, and rotate the Laser TV counterclockwise, to make the image parallel with the screen.

## FILL THE TOP OF THE IMAGE TO THE SCREEN

If the top of the image is wider than the screen, then use the wrench to rotate the left- and right-front feet of the Laser TV clockwise.



If the top of the image is narrower than the screen, then use the wrench to rotate the left- and right-back feet of the Laser TV clockwise, until the left and right borders of the image are parallel with the screen borders.

Next, move the projector further from the screen to fill the image to screen width.

If the back feet are already at their maximum height, rotate the left- and right-front feet of the Laser TV counterclockwise.

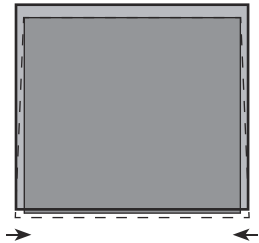



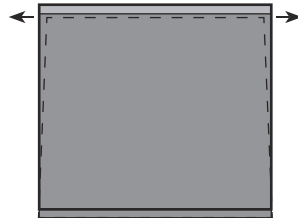





Rotate the back feet clockwise









Rotate the front feet  
counterclockwise

**Do not look directly at the lens when this device is on because the laser light may damage your eyes!**

## STEP 4 Use Your Remote

<i>BUTTON</i>	<i>DESCRIPTION</i>
	Power on/off
	Microphone / Indicator
INPUT	Change Laser TV input source
	Enter Channels/input numbers and special function buttons
	Enter to Live tab in launcher/Display the Electronic Program Guide(if support)/ Return to Live TV*
OK	Confirmation button
	D-pad (up/down/left/right navigation buttons)
	Press to enter Menu
	Return to the previous place in the menu or app
	Display the Home screen

<i>BUTTON</i>	<i>DESCRIPTION</i>
	Volume (up/down)
	Channel (up/down)
	Google Assistant of Laser TV
	Press to Mute or restore sound Press and hold to display Accessibility menu
	Media content control function buttons
App	Quick access buttons to apps
	Accounts & Sign In or switch profile
	Access the settings (direct or through the dashboard in GTV) from any place in the system
MEDIA	Enter the media center

### NOTE:

- The button descriptions are only provided as a reference. The actual appearance of your remote may differ from the buttons that are listed.
- \* Pressing the button in different scenarios will have different responses.

1. Press and slide the back cover to open the battery compartment of the remote control.
2. Insert two AAA or AA size batteries. Make sure to match the (+) and (-) ends of the batteries with the (+) and (-) ends indicated in the battery compartment.
3. Restore the battery compartment.

### **IMPORTANT INFORMATION ABOUT THE REMOTE AND BATTERIES**

- Discard batteries in a designated disposal area. Do not throw them into a fire.
- Remove old batteries immediately to prevent them from leaking into the battery compartment.
- If you do not intend to use the remote control for a long time, then remove the batteries.
- Battery chemicals can cause a rash. If the batteries leak, clean the battery compartment with a cloth. If chemicals touch your skin then wash it immediately.
- Do not mix old and new batteries.
- Do not mix alkaline, standard (carbon-zinc) or rechargeable (NiCd, NiMH, etc.) batteries.
- Do not continue using the remote if it gets warm or hot.
- Call our Support Center immediately on the support website.

### **REMOTE CONTROL RANGE INFORMATION**

- The remote control can work at a distance of up to 26 feet in front of the Laser TV.

- It can work at a 30 degree horizontal or 15 degree vertical angle.( This angle is used by infrared means in an unpaired state.)

### **PAIRING THE REMOTE CONTROL**

1. Pair the remote to the Laser TV after you power it on. Keep the remote control within 10 feet from the Laser TV. Press and hold the [ ← ] button and the [ 🏠 ] button at the same time at least 3 seconds to start pairing.
2. If the remote paired successfully then a confirmation will display on the screen. If it did not pair successfully then an unsuccessful message will display. Repeat step 1.

### **NOTE:**

- If an unknown error occurred with the remote then it could have been caused by interference. Try to remove what's causing the interference and pair it again.
- If an unknown error occurred in the remote control while the battery power is normal, you can take out the batteries and press any key for 1-2 seconds, then the remote control can work normally.
- The remote cannot be paired to the Laser TV while the Laser TV is in standby mode.

## STEP 5 Proceed through the Screen Setup Menu

### PROJECTION MODE

If you need to flip the image over top-to-bottom and/or left-to-right, select the Projection Mode and press the UP/DOWN buttons.

### AUTOMATIC GEOMETRIC CORRECTION

Before you use Automatic Geometric Correction function, ensure that the Laser TV and your mobile device are connected to the same wireless network.

1. Adjust the Laser TV position by using the levelling feet as needed, ensure the frame of the screen is located inside the rectangular border.



2. Press the **OK** button on your remote to continue.
3. Scan the QR Code with your mobile device to begin automatic geometric correction. When the app loads, the Laser TV will display an alignment grid.

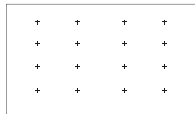

Alignment grid

4. Click "+" on your mobile device to take a photo of the entire screen and image. For best results, stand about 10 feet away from the screen and use landscape mode.
5. Click "**Upload**" on your mobile device to complete the automatic geometric correction.

### NOTE:

- Please ensure you are standing in front of the screen to take the photo, no deviation of more than 25° from the center of the screen.
- Please ensure the whole Laser TV screen is fully visible on the photo, including the Frame of the display.
- Please ensure all the 16 points of the grid on the screen are all in focus when taking the photo.
- Please ensure the Laser TV screen image must take up at least 60% of the overall photo size for correct geometric correction.

### GEOMETRIC CORRECTION

1. Select a point for adjustment using the UP/DOWN/LEFT/RIGHT buttons. Adjust eight main points at the corners and midpoints .

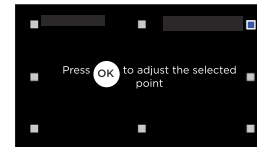

2. Adjust the position of the point by pressing the UP/DOWN/LEFT/RIGHT buttons, then press the Back button to view and select other points. Your changes will apply automatically.

#### NOTE:

- To return the picture position to the factory default, select the **Reset** button on the screen.

#### EYE PROTECTION

In order to protect your eyes, do not look into the lens. This projector is shutting down in 5 seconds, the Laser TV screen is closed immediately.

## Begin to Enjoy Your Laser TV

Your Smart Laser TV is easy to use and brag-worthy!



After you've completed setting up the language, time and network connection, the Home screen will be your starting point for navigating the Laser TV. Using your remote, press the Home button to begin enjoying your Laser TV.

## Text-to-Speech(TTS) and Video Description functionalities on Laser TV

Text-to-Speech (TTS) and Video Description can help you to navigate the menus on the screen and hear an audio description of relevant programs.

Text-to-Speech can convert written text into voice text to help visually impaired people listen to the information they are unable to read. In addition, the Video Description has an audio narration added to certain programs that will describe the main visual elements which visually impaired users may not be able to see.

Follow the steps below to enable the functions:

- Press the  button on your remote to select **Settings > System > Accessibility > TalkBack**.
- Press the  button on your remote to select **Settings > Channels & Inputs > Channels > Video Description**.

When **TalkBack** is turned on, then the contents of each menu displayed can be broadcasted out.

When **Video Description** is turned on, then you can hear the introduction of relevant programs.

<https://www.hisense-usa.com/text-to-speech-hisense-google-laser>

**NOTE:** This function is only applicable in some models/countries/regions.



**Disclaimer:** Subscriptions or other payments may be required to access content through some applications. Some or all of the included or downloaded application services in this Hisense device may not function depending on the Internet connection, local limitations of included applications or other reasons outside of Hisense's control. HISENSE EXPRESSLY DISCLAIMS RESPONSIBILITY FOR ANY APPLICATION SERVICE FROM FUNCTIONING AT ANY TIME, FOR CONTENT IN ANY APPLICATION SERVICE, FOR DISRUPTIONS OF SERVICE, LOCAL OR REGIONAL LIMITATIONS, WARRANTIES OF TITLE, NO INFRINGEMENT, AND FOR IMPLIED WARRANTIES OF MERCHANTABILITY OR FITNESS FOR A PARTICULAR PURPOSE. By purchasing this device, you accept such Disclaimer without any claim on Hisense at any time.

## Maintenance

- Do not touch this device when it is running or just turned off because it may be hot.
- Do not wipe this device with oil because it may deteriorate the exterior or damage the paint. Contact with rubber or ethylene products for a long time may cause stains on this device.
- If the outside of the Laser TV is dirty, turn off the Laser TV and wipe with a dampened soft cloth.
- Do not touch the lens with your hands.
- Do not touch or wipe the lens with ordinary cleaning cloth. Use a dust blower to remove the dust on the lens. Grease, dirt and fingerprints should be cleaned carefully by the professional by using optical cleaning cloth, lens wiping paper or professional cleaning solutions to avoid destroying the optical filming and affecting the image quality.
- To turn off this device, press the Power button on the remote control. Do not cut off the power directly when the device is working.

## Quick Problem-Solving Tips

When you experience an issue with your Cinema, turn it off and on again. If this does not resolve the problem, then refer to the tips below.

### **When I turn on my Laser TV, there is a delay for a few seconds before the picture appears. Is this normal?**

Yes, this is normal. The Laser TV is initializing and searching for previous setting information.

### **No sound or picture**

1. Check if the power cord is plugged into a powered AC outlet.
2. Press the  Power button on the remote control to activate the unit from 'Standby' mode.

3. Check to see if the LED light is on or not. If it is, then the Laser TV is receiving power.

**I have connected an external source to my Laser TV and I get no picture and/or sound.**

1. Check for the correct output connection on the external source and for the correct input connection on the Laser TV.
2. Make sure you have made the correct selection for the input mode for the incoming signal.

**The picture is normal but there is no sound**

1. Check the volume settings.
2. Check if 'Mute' mode is set to On.

**Sound but no picture or black and white picture**

1. If the picture is black and white, unplug the Laser TV from the AC outlet and replug it after 60 seconds.
2. Check that the Color is set to 50 or higher.

**The sound and/or picture is distorted or appears wavy**

1. An electric appliance may be affecting the Laser TV. Turn off any appliances that are nearby and move it farther away from the Laser TV.
2. Insert the power plug of the Laser TV into another power outlet.

**The plastic cabinet makes a "clicking" type of sound**

The 'click' sound can occur when the temperature of the Laser TV changes. This change causes the Laser TV cabinet to expand or contract, which makes the sound. This is normal and the Laser TV is OK.

**The remote control does not work**

1. Confirm that Laser TV still has power and is operational.
2. Change the batteries in the remote control.
3. Check if the batteries are correctly installed.

## NEED MORE HELP?

Additional help is available online at support links. You will find answers to frequently asked questions, downloadable firmware and more. If the problem is still not resolved, then contact us at one of the phone numbers below.

### U.S.A.

<http://www.hisense-usa.com/support/>

**Phone:** 1-888-935-8880

Monday - Friday 9 AM to 9 PM EST

Saturday - Sunday 9 AM to 6 PM EST

**Email:** [Service@hisense-usa.com](mailto:Service@hisense-usa.com)

### MEXICO

<http://www.hisense.com.mx/support/>

**Phone:** 800-008-8880

Monday - Friday: 9:00-21:00 hrs

Saturday: 9:00-15:00 hrs

**Email:** [servicio@hisense.com.mx](mailto:servicio@hisense.com.mx)

### CANADA

<http://www.hisense-canada.com/support/>

**Phone:** 1-855-344-7367

Monday - Friday 8 AM to 8 PM EST

Saturday - Sunday 9 AM to 6 PM EST

Federal holidays excluded

**Email:** [canadasupport@hisense.com](mailto:canadasupport@hisense.com)

## Product Specifications

<b>MODEL NAME</b>	120L5H
<b>DIMENSION (W x H x D)</b>	22.3 x 4.8 x 12.6 inches (566 x 121 x 320 mm)
<b>WEIGHT</b>	20.7 lbs (9.4 kg)
<b>ACTIVE SCREEN SIZE (DIAGONAL)</b>	120 inches
<b>SCREEN RESOLUTION</b>	3840 x 2160
<b>AUDIO POWER</b>	2 x 20 W
<b>POWER CONSUMPTION</b>	350W
<b>POWER SUPPLY</b>	120V- 60Hz
<b>CONNECTIVITY</b>	Built-in Wireless feature (2x2 dual band)
<b>ENVIRONMENTAL CONDITIONS</b>	Temperature: 41°F to 95°F (5°C to 35°C) Humidity: 20% to 80% RH Atmospheric pressure: 86 kPa to 106 kPa
<b>STORAGE TEMPERATURE</b>	5°F to 113°F (-15°C to 45°C)
<b>STORAGE HUMIDITY</b>	10% to 70%, non-condensing
<b>RECEIVING CHANNELS</b>	VHF: 2 - 13, UHF: 14 - 69, CATV: 1 - 125 Digital Terrestrial Broadcast (8VSB): 2 - 69 Digital cable (64/256 QAM): 1 - 135 Next-Gen TV (QPSK-4096QAM): 2-36
<b>TUNER TYPE</b>	Frequency synthesized
<b>RECEIVING SYSTEM</b>	Analog: NTSC Digital: ATSC 1.0/Next-Gen TV/QAM on cable

*Disclaimer: All products, product specifications, and data are subject to change without notice to improve reliability, function, design or otherwise.*

# Certification and Compliance

## FCC Notice

This device has been tested and found to comply with the limits for a Class B digital device pursuant to Part 15 of the FCC Rules. These limits are designed to provide reasonable protection against harmful interference in a residential installation. This device generates, uses, and can radiate radio frequency energy and, if not installed and used in accordance with the instructions, may cause harmful interference to radio communications. However, there is no guarantee that interference will not occur in a particular installation. If this device does cause harmful interference to radio or Laser TV reception, which can be determined by turning the device off and on, the user is encouraged to try to correct the interference by one or more of the following measures:

- Reorient or relocate the receiving antenna.
- Increase the separation between the device and receiver.
- Connect the device into an outlet on a circuit different from that to which the receiver is connected.
- Consult the dealer or an experienced radio/Laser TV technician for help.

**NOTE: THE MANUFACTURER IS NOT RESPONSIBLE FOR ANY RADIO OR LASER TV INTERFERENCE CAUSED BY UNAUTHORIZED MODIFICATIONS TO THIS EQUIPMENT. SUCH MODIFICATIONS COULD VOID THE USER'S AUTHORITY TO OPERATE THE EQUIPMENT.**

The Wi-Fi Module complies with FCC radiation exposure limits set forth for an uncontrolled environment. This device should be installed and operated with a minimum distance of 20 centimeters between the radiator and your body.

## Declaration of Conformity

Trade Name: Hisense

Model: 120L5H

Responsible Party: Hisense USA Corporation

Address: 105 Satellite BLVD Suite I, Suwanee, GA 30024

Telephone Number: 1-888-935-8880

This device complies with Part 15 of the FCC Rules. Operation is subject to the following two conditions: (1) this device may not cause harmful interference, and (2) this device must accept any interference received, including interference that may cause undesired operation.



Dolby, Dolby Vision, Dolby Atmos, and the double-D symbol are registered trademarks of Dolby Laboratories Licensing Corporation. Manufactured under license from Dolby Laboratories. Confidential unpublished works. Copyright © 2012-2022 Dolby Laboratories. All rights reserved.



The terms HDMI and HDMI High-Definition Multimedia Interface, and the HDMI Logo are trademarks or registered trademarks of HDMI Licensing Administrator, Inc. in the United States and other countries.



For DTS patents, see <http://patents.dts.com>. Manufactured under license from DTS Licensing Limited. DTS, DTS-HD Master Audio, DTS-HD, Virtual:X, and the DTS-HD logo are registered trademarks or trademarks of DTS, Inc. in the United States and other countries. © 2021 DTS, Inc. ALL RIGHTS RESERVED.



©2023. All rights reserved. Hisense and the Hisense logo are registered trademarks of Hisense. Other brand and product names are registered trademarks of their respective owners.

