

Instruction Manual

HITACHI

Washing Machine

Fully Automatic

Model

LTL 065SM00



Contents

Environmentally Friendly Waste Disposal	2
Hints and Tips for Eco-friendly Washing.....	2
IMPORTANT SAFEGUARDS	4
CARE AND MAINTENANCE	6
PRODUCT DESCRIPTION.....	7
ACCESSORIES	7
INSTALLATION INSTRUCTIONS	8
CONTROL PANEL	13
GENERAL USAGE.....	15
PROGRAM	17
FUNCTIONS & SPECIALS	19
TROUBLE SHOOTING GUIDE	21
NOT FAILURE INDICATION.....	22
SPECIFICATIONS	45

Thank you for purchasing a Hitachi fully automatic washing machine.

- Please read this Instruction Manual carefully for proper operation of the machine.
- Please keep this Instruction Manual for future reference.

For household use only



Please read this instruction manual first!

Dear Customer,

Thank you for choosing Hitachi product. We hope that you get the best results from your product which has been manufactured with high quality and state-of-the-art technology. Therefore, please read this entire instruction manual and all other accompanying documents carefully before using the product.

Follow all warnings and information in the instruction manual. Thus, you protect yourself and your product against possible dangers.

Keep the instruction manual. If you hand over the product to someone else, provide the Instruction manual as well. Warranty terms, usage and troubleshooting methods of your product are in instruction manual.

Environmentally Friendly Waste Disposal

Disposing of the packaging

The shipping package has protected your new washing machine on its way to your home. All materials are ecologically harmless and recyclable. Please contribute to a better environment by disposing of packaging materials in an environmentally conscious manner.

Ask your dealer about current means of disposal.

Risk of choking!

Do not let children play with packaging and associated parts.

There is a risk of suffocating with plastic bags and collapsible boxes.

Disposing of your old appliance

You can dispose your old appliances. Environment-conscious recycling can reclaim them to valuable new materials.

Risk of death!

To dispose the old appliances:

1. Unplug the power plug from appliances you are no longer using.
2. Cut off the power cord and dispose of it with the plug.

If you wish to discard this product, contact your local authorities or dealer and ask for the correct method of disposal.

Hints and Tips for Eco-friendly Washing

- Keep the load limit of each program.
- This washing machine features power-saving operations with a built-in inverter controller which enables the machine to optimize operations according to the conditions of your clothes.
- Add detergent according to the degree of soiling, laundry size, and water hardness. Follow the detergent manufacturer's instructions regarding the amount of detergent to use.
- You can use further enhanced water-saving technology such as "Spin Shower Rinse". Water consumption is less than the former models.

- This appliance is intended to be used in household and similar applications such as: (IEC 60335-2-7)
 - Staff kitchen areas in shops, offices and other working environments;
 - Farm houses;
 - By clients in hotels, motels and other residential type environments;
 - Bed and breakfast type environments;
 - Areas for communal use in blocks of flats or in laundrettes.
- Do not forcibly open the lid during operation: Lid Lock Switch is designed to prevent from opening the lid during operation. This is because touching the washing tub while it is spinning may result in serious injury. If you can open the lid during operation, please stop using the Washing Machine immediately and refrain from touching the inside. Contact your local service center for repair.
- This appliance is not intended for use by persons with reduced physical, sensory or mental capabilities, or lack of experience and knowledge (including children) unless they have been given supervision or instruction concerning use of the appliance by a person responsible for their safety.
- If there is a water outage or if you are removing the water supply hose to reattach it, close the tap and press the Start/Pause button, then wait 40 seconds and slowly open the tap. Air pressure from a large amount of air in the water pipes may damage the washing machine.

Child safety

- Keep packaging out of reach of children and infants. Danger of suffocation.
- Do not let children climb onto the washing machine or to get into the tub. Do not leave boxes or chairs near the washing machine that children could use to climb onto it. This may cause injury.
- Children should be supervised to ensure that they do not play with the appliance.
- All packaging materials must be removed before using the washing machine. This may cause malfunction or abnormal vibration.
- Check inside the tub before operating the washing machine. Check that no pets or small animals are in the tub.
- Do not wash items through which water does not flow easily such as raincoats, wet suits, ski suits, sleeping bags, cushions, pillows, shoes, shower curtain. The washing machine may not work properly, or it may cause injury or damage the washing machine.

- Do not fold and stack large items such as blankets together when washing them.
- Do not use a laundry net that is larger than 40cm on a side. The clothes may become off balance and cause abnormal vibration during the spin cycle.
- Do not load laundry over the lower part of the liquid load balancer (dashed line). This may cause laundry to fly out of the tub during the spin cycle and damage the clothes or the washing machine, or cause a water leak.
- Always put detergent into the detergent dispenser when washing laundry.
- Do not press the buttons with sharp pointed objects.
- Do not put heavy objects, liquid-filled containers or equipment which produces heat on the washing machine or its top.



Care and maintenance

- If detergent, fabric softener or bleach spills on the surface of the machine, clean it up with a damp cloth immediately. The plastic or steel parts of the washing machine may be damaged.
- Do not place equipment that produces heat near the washing machine. This may cause deformation of the washing machine.







IMPORTANT SAFEGUARDS

Please read this instructions manual carefully before using your machine.

- The precautions stated here are classified as “Warning” and “Attention” according to the damage and the emergency caused by misoperation, and are described respectively in line with the marks below.

 Warning	Misoperation may cause death.
 Attention	Misoperation may cause body injury or damage the machine.

		
This mark indicates the content of warning or attention.	This mark indicates the prohibited action.	This mark indicates the compulsory action to be carried out.

 Warning	
<p> • Dismantling, repair or alterations should only be carried out by professional technician as otherwise you may be subject to electric shock, may cause fire or get injured.</p>	<p>• This washing machine is equipped with a 3 pin plug which includes an earthing wire. This appliance must be earthed.</p>  <p style="text-align: right;">Grounding</p>
<p>• Electricity supply must be unplugged with dry hands. Otherwise, this may cause electric shock.</p>  <p style="text-align: right;">Wet hands Prohibited</p>	<p>• Do not put water in direct contact with the unit during maintenance and repair. This may cause short circuit or electric shock.</p>  <p style="text-align: right;">Prohibited</p>
<p>• Damaged or loosen wire or plug should not be used. Otherwise electric shock, short circuit or fire may take place.</p> <p>• Do not damage wire. Do not damage or alter the wire forcibly bend, pull twist or handle the wire. Beside, please do not put weight on or trap the wire. Damage of wire may cause electric shock or fire.</p>  <p style="text-align: right;">Prohibited</p>	<p>• Do not put gasoline, benzene, alcohol, thinner of fabrics with these stains into or near to the washing machine. To prevent fire or explosion which may cause injuries.</p>  <p style="text-align: right;">Prohibited</p>

IMPORTANT SAFEGUARDS

⚠ Warning

- Keep child away from the wash/spin tub and do not place box or shelves next to the washing machine.

Children may fall into the basket resulting in injuries.

This appliance is not intended for use by persons (including children) with reduced physical, sensory or mental capabilities, or lack of experience and knowledge, unless they have been given supervision or instruction concerning use of the appliance by a person responsible for their safety.



Prohibited

- Do not put your hand into the wash/spin tub until it has stopped completely.

Even when the spinning of the tub is slow, there is still a danger of being caught in the motion, resulting in injuries. Particular attention should be paid when children are around.



- Do not put your hands into the wash/spin tub during the washing and rinsing process.

Even when the spinning is slow, hands may be trapped by clothes. If necessary, please press pause button, and put your hands into the tub after it has stopped completely.



Prohibited



- Please use the single socket with special voltage and current matched with plug marked specification.

The share of the same socket with other electric appliances may cause fire due to excessive loading.



Clear

- Thoroughly wipe the power plug when dirt is adhering the prong or around the base of the prong.

Failure to do so may cause a fire.

- Washing machine should not be installed in humid place or in places exposed to wind and rain.

Otherwise, electricity leakage causing electric shock or fire may occur.



Prohibited

- This washing machine is strictly prohibited to get close to the locations with candle, mosquito-repellent incense, dog-end or other kinds of open flame.

To avoid injuries caused by the lock damage.



Prohibited

⚠ Attention

- Do not pull the wire from the socket when unplugging the unit.

To avoid electric shock or fire cause by short circuit may result.



Prohibited



- Please unplug the unit when not using the unit for a long period of time.

Electric shock or leakage may occur due to deformation of plastic parts of the unit.



- Electricity supply must be unplugged with dry hands during maintenance and repair.

Otherwise, electric leakage causing injuries may occur. If the power cord or supply cord is damaged, the manufacturer or its service agent or similarly qualified person must replace it in order to avoid a hazard.

- Do not connect to the hot water supply, if use warm water, water of above 50°C should not be used for washing.

Electric shock or leakage may occur due to deformation of plastic parts of the unit.



Prohibited

IMPORTANT SAFEGUARDS

⚠ Attention

- Do not wash, rinse and spin the water proof fabric or cloth.

Sleeping bag, raincoat, cover of skiing, utilities, bicycles, cars and motors. Otherwise may lead to injury by abnormal vibration during spinning or damage the washing machine, wall, floor and clothes.



Prohibited

- Do not stand on or put weight on the top of the unit.

Otherwise, deformation and damage may cause injuries.



Prohibited

- Keep hands and feet away from the bottom of the washing when it is in motion.

Ports in motion beneath in the unit may cause injuries.

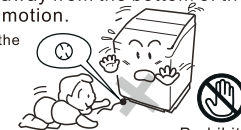

Prohibited



Water leakage

- Water supply hose should be tightly screwed to the unit.

Failure to do so may result in water leakage. Used for a long period of time, the unit may result in water leakage caused by loosen union nut. So please check it in time and screw tightly again.

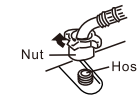

Water leakage

- Check water supply hose connection by turning on the water before washing. To prevent damages caused by possible water leakage due to loosen screw or not tighten.

The new hose-sets supplied with the appliance are to be used and that old hose-sets should not be reused.

Do not block the ventilation openings at the bottom of washer by carpeting when the washer is installed on a carpeted floor.

- Please turn off the water tap when not using the unit.

To prevent damages caused by water leakage.



CARE AND MAINTENANCE

Clean washing machine

Use soft clothing to wipe off the water or dirt on the surface of the washer.

- Do not spray water directly to the washer body.
- Detergent, propellant and other chemicals are not allowed to use to avoid the damages on the surface.



Clean the water inlet valve

(Suggest cleaning it every 6 months)

After long time use, the water inlet mesh bag may be blocked with crud, please load off the water inlet hose, take out the water inlet mesh bag from the water inlet valve, clean the mesh bag, then assemble the mesh bag in the valve and load the water inlet hose.



Water Inlet

Clean hose filter

(Suggest cleaning it every 6 months)

- Turn the nut of water supply hose counter clockwise, take down water hose.
- Clean the crud with a toothbrush.
- Install the clean water hose



Clean lint filter

(Suggest cleaning it every time after use)

- Take out the lint filter.
- Pull out the scraps and wash the lint filter in the water.
- Install the filter (aim the frame claw to the groove below).

(Lint filter is easily destroyed parts).



PRODUCT DESCRIPTION

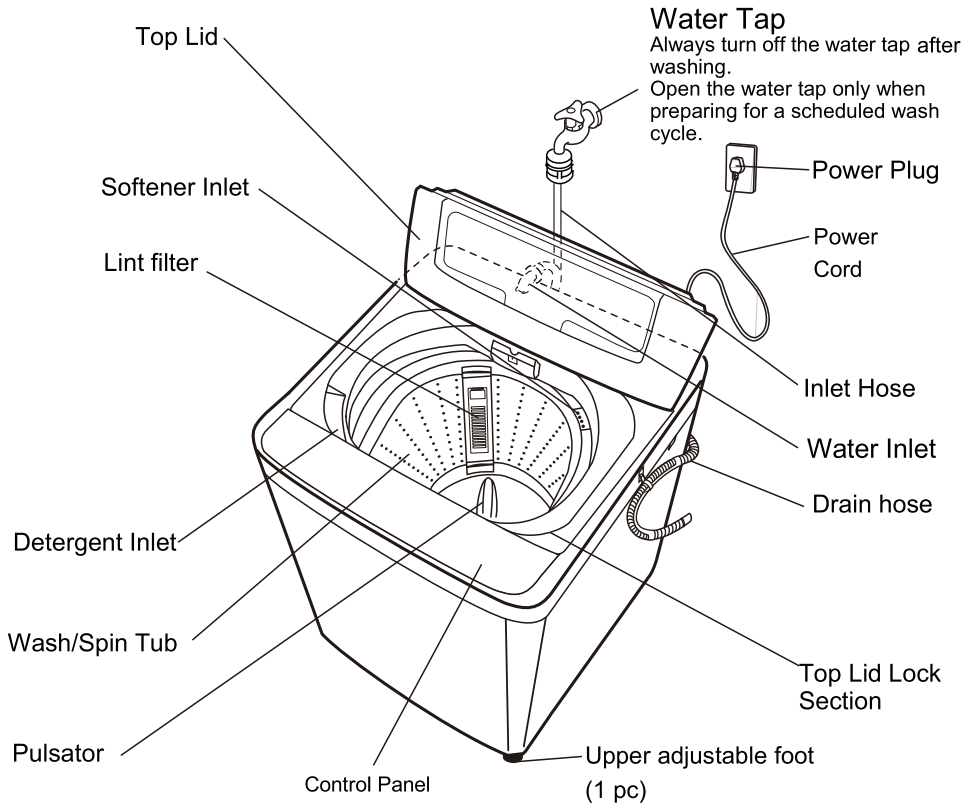

INSTALLATION INSTRUCTIONS

Installing the Bottom Cover

1. Take out the bottom cover and screw in the accessories bag.
2. Gently lay down the back side of washer on a soft mat or cushion. (Be careful not to dent the frame.)
3. Insert the attached bottom cover into the hooks of leg by straightly pushing until it reaches into the back hooks.
4. Fasten the bottom cover with a screw.
5. Gently set the washer upright.

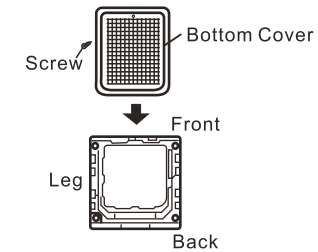

Location of Washer

1. Choose a dry location out of sunlight for the washer.
2. Install the washer on a stable and level surface.



3. Adjust the adjustable leg of washer if necessary to make the washer level as shown in the diagram.
 - The maximum permissible inclination of the supporting surface is 2°.

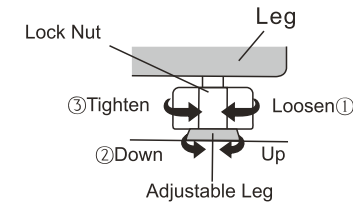

CAUTIONS:

- The washer must be installed so that its bottom opening will be not obstructed by the carpet etc.
- If the washer installed on the carpeted floor or elastic table may cause vibration issue.

ACCESSORIES

LTL 065SM00

LTL 065SM00					
Instruction manual (1 book)	Drain Hose (1 piece)	Water Supply Hose (1 piece)	Bottom Cover (1 piece)	Screw (1 piece)	Warranty Card (1 piece)

INSTALLATION INSTRUCTIONS

Connecting the Water Supply Hose

1. Check that sealing washers are firmly seated.
2. Attach the curved end of the hose to the inlet valve of the washing machine. Tighten the coupling nuts securely by hand.
3. Attach straight end of the hose to the tap. Tighten the coupling nuts securely by hand.
4. Turn on the taps and check for leaks. Tighten the coupling nuts firmly if there is any leakage. If water pressure is strong, close the water tap completely then open it slightly.

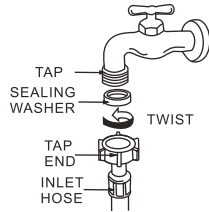

CAUTIONS:

- Do not use water which is hotter than 50°C.
- If the water supply hose does not match with your faucet, please consult your dealer.

Installing Water Supply Hose to the Washer

Turn the nut clockwise till the nut turned tight while holding the hose.

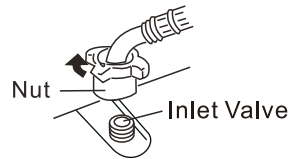

Turn the nut counterclockwise after turning the faucet off when you want to detach the water supply hose.

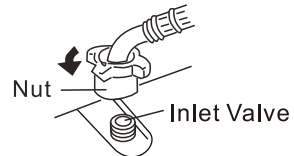

INSTALLATION INSTRUCTIONS

For high draining level installation

Installing the Drain Hose

1. Connect the water drainage hose with the water drainage joint on the back of the body. Fully insert it into the position to avoid leakage.
2. After the connection is completed, please use hose clipper to clamp the water drainage hose to avoid falling off.

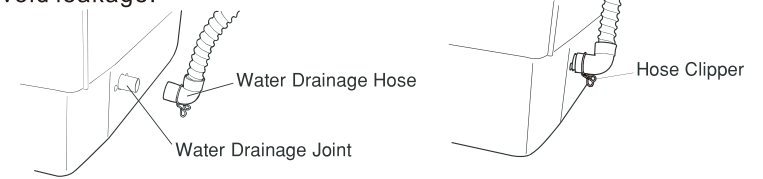

3. ① Insert the fixing holder of water drainage hose into mounting hole.
② As shown below, rotate the fixed leg for 90 degree into the hole.
4. Pull the water drainage hose straight, concave to fix into the fixing holder of water drainage hose.

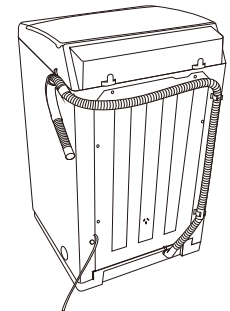
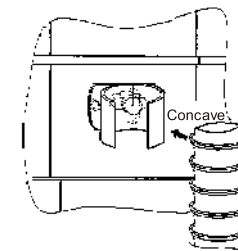
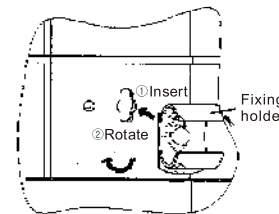

INSTALLATION INSTRUCTIONS

CAUTION:

- Do not release the water drainage hose to avoid water splashing.
- Do not use extended water drainage hose.
- Do not immerse the tail of the U-shaped hose in the water.
- Be sure not to install the water drainage hose at a position lower than water drainage joint, otherwise, it could lead to difficulties in water drainage .

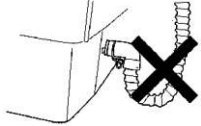

- Please make sure to keep the height of drain hose below 1000 mm during washing, otherwise, the washer mightn't work properly.

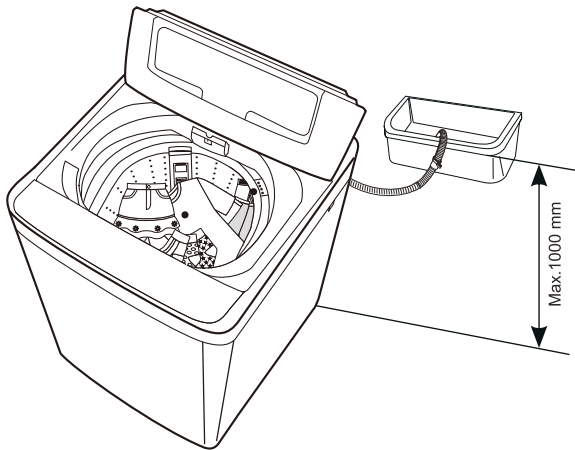

INSTALLATION INSTRUCTIONS

For low draining level installation

Installing the Drain Hose

1. Pinching the two bands of the clamp on the drain hose, connect it to the pump (rear of cabinet) and fix the hose band.
2. Pull the drain hose upward and fix it to the hose clip at the back cover of cabinet.
3. Put the drain hose to drain spout when washer start working.

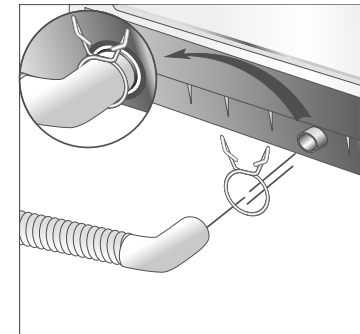

CONTROL PANEL

Air Jet Dry

Dehydrates and air-dries clothes with loads up to 1.5kg in 180 minutes.

Program

- Select a washing program according to the type and stains on the laundry.
- The indicator for the selected program lights up.

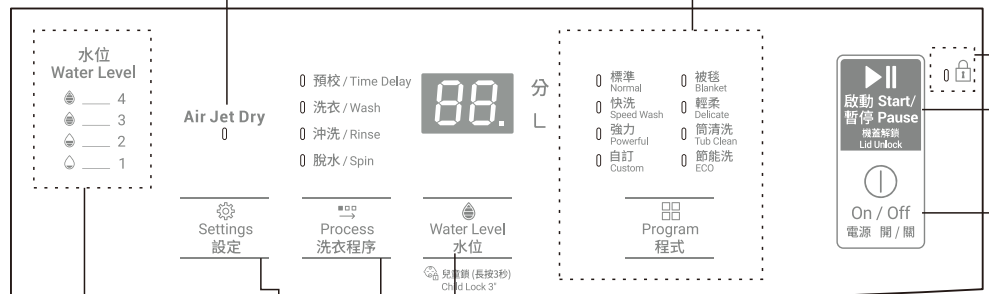

Based on different dirty of the clothes, select the different water level.

Setting

Set the time for [Time Delay], [Wash], [Spin], [Air Jet Dry] and the number of [Rinse] cycles.

Process

- Make the necessary settings, such as "Time Delay" "Wash" "Rinse" or "Spin".
- Long press to set the function of draining residual water.

Water Level

- Depending on the wash load, the water level can be automatically adjusted to a setting without gear levels. The quick wash program automatically adjusts.
- When setting manually, you can choose from 4 water level options.
- Switch to your desired water level.
- This feature is not available in the "Tub" program.

Power on/off

Press this button to switch on the washing machine. To switch off the power, press it again. If idle for 10 minutes after machine is turned on, the power will be automatically cut off. After washing program finishes, the power will be cut off automatically after 5 seconds.

Start/Pause

- Press this button to start a washing program. Press once to pause the operation, to resume, press the same button again.
- Long press to set cancel or restore the end beep.

Indicates whether the top lid is locked

When the light is on...
The top lid is locked and cannot be opened.

When the light is flashing...
Locking action is in progress

When the light is off...
The top lid can be opened.

GENERAL USAGE

1.Preparations

- ① Connect and lay down the drain hose.
- ② Connect the water inlet hose to the water tap.
 - Before turning on the water tap, make sure the screws are tightened.
If the screws are loose, it may cause water leakage.
- ③ Plug the power cord into a power socket.
- ④ Put in laundry.

THE PREPARATION OF LAUNDRY BEFORE WASHING





- Make sure that nothing remains in the pocket. (Pin, coin etc. that can possibly damage clothes or the washing machine, and the extra noise may cause damage to the washing machine).
- Turn the clothes inside out to get rid of scraps.
- Woolen items like women underwear, articles with embroidery, nylon etc, should be placed in a laundry net for extra protection.
- Close the fastener and tie loose laces.
- Brush off the dirty parts like dust, sand.
- Put light clothes down. Please pause the operation and push them into the water when they float up.
- Please separate the washing of white clothes from coloured clothes, coats from underwear.

- 2.Add detergent in the detergent dispenser box or directly into the tub.
- 3.Press the "Power On/Off" button to turn on the power and select the desired program and/or function.
- 4.Close the lid and press the "Start/Pause" button.

CAUTIONS:

- You can use softener, pour the softener slowly to softener dispenser before washing.
- Too much detergent causes poor rinsing and too little detergent causes poor washing result.
- If the door of the washing machine is not closed, the washing machine will not be able to complete the washing process normally and there will be alarm alert.

GENERAL USAGE

DETERGENT AND LOAD RECOMMENDATIONS				
Water Level	1	2	3	4
Detergent Indicators				
Powdered detergent volume (g)	10~15	15~22	20~26	26~32
Water Consumption (Litre)	16L	27L	37L	45L
Other detergent volume	You may adjust the detergent volume according to the type of detergent-follow recommendations on package.			

PROGRAM

Program	Maximum washing capacity	Default time	Default parameters					Air jet dry3H
			Water level	Soak / min	Washing / min	Rinse / times	Dehydration / min	
Normal	Rated capacity	36~40Min	Initial:auto(2~4) Manual:1-4	—	8~9 (0~15)*	2 (0~3)*	7 (0~10)*	●
Speed Wash	≤3kg	10Min(1) 28Min(2) 31Min(3-4)	Initial:auto(2~4) Manual:1-4	—	3min(1-2) 6min(3-4) (0~15)*	1min(1-2) 2min(3-4) (0~3)*	2min(1-2) 5min(3-4) (0~10)*	●
Powerful	Rated capacity 70%	43~48Min	Initial:auto(2~4) Manual:1-4	—	11~12 (0~15)*	2 (0~3)*	9 (0~10)*	●
Custom	Rated capacity	46~49Min	Initial:auto(2~4) Manual:1-4	—	13 (0~15)*	2 (0~3)*	9 (0~10)*	●
Blanket	Blanket<4.5kg	47	Initial:4 Manual:3-4	—	12 (0~15)*	2 (0~3)*	8 (0~10)*	○
Delicate	≤1.5kg	21~24Min	Initial:3 Manual:2-4	—	4 (0~15)*	2 (0~3)*	1 (0~2)*	○
Tub Clean	0	11H42min	Initial:4	11H	5	3	5	○
ECO	Rated capacity	37	Initial:4 Manual:1-4	—	12 (0~15)*	2 (0~3)*	4 (0~10)*	●

Note: * It indicates that it can be adjusted.

- Based on the water pressure or the type of loading, etc., the actual washing time is slightly different from the time shown in the above table.
- If the load is not placed according to the recommended washing capacity, the expected washing effect may not be achieved.
- If you choose different washing time, rinse times, and function options, the displayed time will be different.

●	None by default, selectable
○	None by default, not selectable

FUNCTIONS & SPECIALS

Preset function

- The delay time is the time from the start to the end of the program.
Reservation time setting range of 1-12 hours.
- Before setting the preset function, first open the water tap, lay down the drain hose, and check whether the universal joint is tightened to prevent water leakage.

How to set Preset function

1. Open the door and press the "Power On / Off" button.
2. Add the laundry into the washing tub.
3. Select the appropriate program, function and water level.
4. Press the "Process" button, the "Time Delay" light blinks, press the "Settings" button to set the delay time.
 - Delay time can be set from 1-12 hours.
5. Add detergent and close the door.
6. Press the "Start/Pause" button.
 - After about one minute, all lights except the program light are off.
(If the child lock function is set, the child lock light is on.)
 - To view the selected program, just press the "setting" button. The selected program will be displayed for 5 seconds.
 - To change program, turn off the machine and reset.
 - The preset function will be canceled after unplugging power cord or power failure.

Intelligent memory function

It is available for Standard, Quick Wash, Power and Custom programs.

At the end of the last run, simply press the Start/Stop button to memorize the selected program. Standard, Quick Wash and Power Programs do not memorize the manual settings and run according to the default program, while Custom Programs can be run with the same manual settings as the last time.

Double-level power wash

In order to increase the concentration of the detergent, during the washing process, when the water reaches two levels lower than the set level, washing will start with water continuous inflowing.

- This function is not applicable to water level 1 or 2.
- This function is not applicable to some programs.

FUNCTIONS & SPECIALS

Child lock function

Lock the buttons of control panel against improper use (by children) with this function. After the child lock function is turned on, all other buttons will not respond except the "Power On/Off" button.

- How to set: Press the "Power On/Off" button. After turning on the power, press and hold the "Water Level" button for 3 seconds until you hear a beep sound, the child lock function is activated. To cancel repeat the above steps.

Normal function

It is suitable for daily washing of cotton and linen fabrics, mixed clothes, etc.

Speed Wash function

It is suitable for the quick washing of clothes with light stains.

Powerful function

It is suitable for washing severely dirty clothes (such as work clothes, etc.)

Custom function

It is suitable for daily washing of cotton and linen fabrics, mixed clothes, etc. And can remember the program and parameters.

Blanket function

It is suitable for the washing of large blankets and cotton and wool textiles.

Delicate function

Suitable for gentle washing of delicate clothes.

Tub Clean function

Wash for a long time to clean the inner bucket.

ECO function

It is suitable for the washing of cotton and cotton-linen clothes. This program belongs to the energy label reference program.

TROUBLE SHOOTING GUIDE

When the following problems occur, the microcomputer will detect the abnormal condition and an electronic buzzer sounds for approximately 10 seconds and the indicators flash as shown below. At the same time, the washer stops operation.

Display	Problems to be checked	Solution
E1 No water entering	<ul style="list-style-type: none"> · Is the water tap opened? · Is the water inlet mesh clogged by foreign matter? · Is it frozen? · Is there a water outage? · Is well water used? 	After spot check, press, pause twice (Run again)
E2 No drainage	<ul style="list-style-type: none"> · Please verify the drain hose <ul style="list-style-type: none"> · Did you forget to lay it flat or is it crushed? · Is the middle section lifted more than 15 cm? · Is the drain outlet clogged? · Is the drain outlet (filter or trap) clogged with thread 	
U3 No spinning	<ul style="list-style-type: none"> · Are the clothes leaning to one side? · Is the machine tilted or swaying? 	
E:41,42,43,44	Top lid lock related exceptions <ul style="list-style-type: none"> · Is the top lid securely closed? · Did you forcibly open the top lid during rinsing, spinning, or while the tub cleaning function or child lock is set? <p><u>Display E41 • E42 • E43 • E44 if the problem persists after investigation</u></p> <p>→ It may lead to damage to the top lid mechanism. Please unplug the power cord from the socket, turn off the water tap, and contact the store where you purchased it for repairing as soon as possible.</p>	
U4	Not operating (paused) Is the top lid opened?	Close the top lid
Ud	Display after operation Have you performed the anti-freezing setting (to drain any residual water)?	
UL	Is the top lid opened? Is the child lock set?	
EA EU etc.	Adjustment is required for overhaul of control components. Please unplug the power cord from the socket, turn off the water tap, and take it to the store where you purchased it for repair as soon as possible.	

NOT FAILURE INDICATION

1. During washing or rinsing, there is still water inletting. This is possibly automatic water adding due to water level decrease.
2. Spin tub turns or stops timely at the beginning of spinning. This is intermittent spinning for better spin effect.
3. Water is inletting and rinsing sometimes during spinning. This is automatic lean-correction due to clothes is not placed evenly inside.
4. There is sound like water flow after spinning. This is the sound of balance liquid in balance ring. It is for reducing vibration of spinning.
5. Control panel keeps warm after power off, this is caused by remembering circuitry working.
6. Power off during working and the washer could not continue working. Please set the program again.

NOTE: The trouble indicators can be released by pressing the START/PAUSE button once if you want to release the emergency stop. Then press the START/PAUSE button again to restart the operation.

使用說明書

洗衣機

全自動

型號

LTL 065SM00



感謝您購買日立全自動洗衣機。

- 請仔細閱讀本說明書，以確保機器的正確使用。
- 請保存好本說明書，以備日後參考之用。

HITACHI

目錄

環保廢物處理.....	25
環保洗衣提示.....	25
重要的安全措施.....	27
保養和維護.....	29
各部件名稱.....	30
附件說明.....	30
安裝指引.....	31
控制面板.....	35
一般的使用方法.....	37
程序表.....	39
功能介紹及設定方法.....	41
故障排除指南.....	43
並非故障的情況.....	44
規格.....	45

僅限家庭使用



請先閱讀本說明書!

尊敬的客戶，感謝您選擇日立產品。我們希望你們的產品能取得最好的效果，這些產品是用高品質和最先進的技術製造的。因此，在使用產品之前，請仔細閱讀整個使用說明書和所有其他隨附文件。請遵循說明書中的所有警告和信息。這樣，您可以保護自己和您的產品免受可能的危險。請保留使用說明書。如果您將產品轉交給他人，也請一併提供使用說明書。產品的保修條款、使用說明以及故障排除方法都包含在使用說明書中。

環保廢物處理

為保障運輸安全，我們已為您的新洗衣機提供妥善包裝。所有材料均為生態無害並可回收利用。請以環保方式處理包裝材料，致力創造更好的環境。請諮詢您的經銷商當前處理方式。

△ 窒息風險!

請勿讓小孩用包裝及相關部件玩耍。
存在被塑料袋及可折疊箱導致窒息風險。

舊電器處理

您可以處理您的舊電器。可以環保回收改造成有價值的新材料。

△ 死亡風險!

處理舊電器:

1. 拔掉不再使用的電器的電源插頭。
 2. 切斷電源線，並與插頭一起處理。
- 如果您希望棄置本產品，請聯繫當地相關機構或經銷商，並查詢正確的處理方法。

環保洗衣提示

- 不得超過每個程式的負載功能
- 本洗衣機具備節能操作功能，內置的逆變器控制器使洗衣機能根據衣物狀況優化運轉。
- 根據污漬程度、衣物大小和水硬度的不同適量添加洗衣劑。請遵循洗衣劑製造商提供的用量說明。
- 您可以使用更先進的節水技術，如“旋轉淋浴沖洗”。用水量比以前的型號少。
- 該設備旨在用於家庭和類似應用，例如:(IEC60335-2-7)
 - 商店、辦公室和其他工作環境中的員工廚房區域;
 - 農場房屋;
 - 在酒店、船屋和其他住宅環境中的客戶使用;
 - 住宿和早餐類型的環境;
 - 公寓樓或洗衣房的公共使用區域。

1. 請勿在操作過程中強行打開蓋子:蓋子鎖定開關旨在防止在操作過程中打開蓋子，因為洗衣機旋轉時若與之接觸，可能會導致嚴重傷害。
2. 如果您能在操作過程中打開蓋子，請立即停止使用洗衣機，並避免觸碰內部部件。請聯繫您當地的服務中心進行維修。
3. 本電器不適用於身體、感官或心智能力受限者或缺乏經驗和知識的人羣(包括兒童)，除非他們已獲得由負責其安全的人員提供的有關使用該電器的監督或指導。
4. 如果遇到斷水情況，或者您在拆卸供水軟管以便重新連接時，請關閉水龍頭並按下“開始/暫停”按鈕，然後等待40秒，再緩緩打開水龍頭。水管內大量空氣產生的氣壓可能會損壞洗衣機。

兒童安全

將包裝遠離兒童和嬰兒，會有窒息風險。



1. 切勿讓兒童爬上洗衣機或進入洗滌槽。不要在洗衣機附近放置箱子或椅子，以免兒童利用這些工具爬上洗衣機，從而可能造成傷害。應監督兒童，確保他們不玩弄該電器。
2. 在使用洗衣機之前，必須移除所有包裝材料。這可能會導致故障或異常振動。
3. 在操作洗衣機之前檢查浴缸內部。確保浴缸內沒有寵物或小動物。
4. 請勿用洗衣機清洗那些水流不暢的物品，如雨衣潛水服、滑雪服、睡袋、靠墊、枕頭、鞋子、浴簾。這樣可能會影響洗衣機的正常運行，甚至造成傷害或對洗衣機造成損害。
5. 洗滌時不要摺疊和堆疊大件物品，如毯子。
6. 不要使用邊長超過40厘米的洗衣網。衣物可能會在脫水過程中失去平衡並導致異常振動。
7. 請勿將衣物載入液體負載分配器(虛線所示)的下部區域，因為這可能會導致衣物在甩乾循環期間飛出桶體，從而損壞衣物或洗衣機，或者造成漏水。
8. 洗滌衣物時，務必將洗衣粉放入洗衣粉分配器中
9. 不要用尖銳的物體按壓按鈕。
10. 請勿在洗衣機上放置重物、盛有液體的容器或產生熱量的設備，因為這可能會損壞洗衣機或其頂部。

保養和維護







- 如果洗衣劑、織物柔順劑或漂白劑濺到洗衣機表面，應立即用濕布擦拭乾淨。洗衣機的塑膠或鋼製部件可能會因此受損。
- 請勿將產生熱量的設備放在洗衣機附近。這可能會導致洗衣機變形。

注意事項











- 使用前詳細閱讀「注意事項」並正確使用。
- 為了防止對使用人和他人造成傷害或財產損壞，現就安全方面需要務必遵守的事項，作如下說明。

	警告	此標示欄的內容為「有死亡或受傷的可能性」。
	注意	此標示欄的內容為「有受傷及機器損壞的可能性」。

		
「警告或提醒注意」的內容。	「禁止」的內容。	「注意」的內容。

 警告	
<p> 不可改裝，非專業維修人員禁止拆解及修理洗衣機。</p> <ul style="list-style-type: none"> • 這會做成火災、觸電、受傷。 	<p>請務必正確接地。</p> <ul style="list-style-type: none"> • 為防止漏電事故的發生。  <p>插座良好接地</p>
<p>手潮濕時請勿插入或拔下電源線插頭。</p> <ul style="list-style-type: none"> • 以避免觸電的危險。  <p>禁止濕手</p>	<p>洗衣機本體各部分，請勿直接用水沖洗。</p> <ul style="list-style-type: none"> • 以避免絕緣不良，導致觸電的危險。  <p>禁止</p>
<p>電源線的保護。</p> <ul style="list-style-type: none"> • 使用時請注意電源線外皮是否受損傷，有無不合理彎曲或拉伸及重物壓住變形等現象，電源線破損導致絕緣不良，這是發生觸電、火災的原因。電源線損壞時，需由專業維修人員維修更換。  <p>禁止</p>	<p>請勿洗滌沾有揮發性溶劑的衣物。</p> <ul style="list-style-type: none"> • 請勿洗滌沾有汽油、煤油、稀釋劑等的衣物。這樣可能引起火災或爆炸。  <p>禁止</p>

注意事項

 警告	
<p>不要讓兒童在洗衣機上或洗衣/脫水桶內玩耍。</p> <ul style="list-style-type: none"> • 如果兒童不慎掉入洗衣/脫水桶內，會產生嚴重的傷害。 • 該電器不適用於(包括兒童): 具有身體障礙、感官障礙、精神障礙者，或缺乏必要經驗與常識者。必須要在安全監護人的指導和監督下才可以。  <p>禁止</p>	<ul style="list-style-type: none"> • 不要將手伸進洗衣/脫水桶內直至機器停止運轉。即使內桶旋轉緩慢但是仍有危險，導致人體受傷。尤其當兒童在周邊的時候一定要特別注意。 • 不要在洗衣機洗衣或過水過程中將手放入洗衣/脫水桶內。即使旋轉速度很慢，但是手仍然會被衣服纏住。如有必要請按暫停鍵，等機器徹底停止旋轉後再將手伸進桶內。  <p>禁止觸摸</p>
<p> 不可使用額定數值以外的電壓、頻率。</p> <ul style="list-style-type: none"> • 請單獨使用額定電壓的電源插頭，勿與其它電器共用電源，以免導致火災危險。 	<p> 電源線插頭的灰塵等要定期清除。</p> <ul style="list-style-type: none"> • 電源線插頭上若灰塵堆積，會因濕氣造成絕緣不良引起火災。 <p>注意</p>
<p>避免安裝於潮濕及雨淋處。</p> <ul style="list-style-type: none"> • 電源絕緣不良，成為漏電或故障的原因。  <p>禁止</p>	<p>請勿靠近煙火。</p> <ul style="list-style-type: none"> • 請勿靠近煙火，且勿將點燃的蠟燭、香煙、蚊香及水壺放在洗衣機上，這是做成火災及變形的主要原因。  <p>禁止</p>
 注意	
<ul style="list-style-type: none"> • 電源線插頭插入或拔出時，手指須緊握插頭絕緣部份施力，請勿觸碰插頭的金屬插片，以避免觸電或施力於導線端，導致電源線內部導線斷裂。 • 在移動洗衣機時，務必先拔下電源線插頭。  <p>禁止</p>	<ul style="list-style-type: none"> • 長時間不使用洗衣機時，請拔掉電源。否則可能會因為塑料件變形做成漏電或者觸電。 
<ul style="list-style-type: none"> • 保養時，請務必從插座上拔下電源線插頭，此外，手潮濕時不可插拔電源線插頭，避免做成觸電、受傷。 • 如果電源線損壞，為了避免危險，必須由生產商、其代理商或相關的合格人員替換。 	<ul style="list-style-type: none"> • 熱水會使塑料部件變形，這是發生故障的原因。  <p>禁止</p>

注意事項

⚠ 注意

防水性或不吸水的洗滌物不可以放在洗衣機內洗滌。

- 以避免洗衣機或脫水時，產生異常震動。(如雨衣、車套)

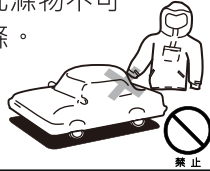

請勿將幼兒或重物放置在洗衣機上。

- 以避免部件變形或破損導致危險的發生。

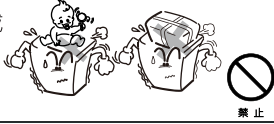

洗衣機運轉中，請勿嘗試接觸內部運動部件。

- 以避免受傷的危險。



- 洗滌之前檢查供水軟管連接處。螺釘鬆開或不緊密可能造成漏水。
- 請使用隨機附上的新的軟管裝置，舊的軟管裝置不可重複使用。
- 如洗衣機安放在鋪有地毯的地板或彈性較大的支撐臺上時，可能會造成洗衣機的震動。

- 供水管應擰緊，否則可能會導致漏水。水管接口處長時間使用可能會導致螺母鬆動造成漏水，請檢查時再次擰緊。

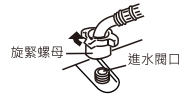

洗衣機不使用時。

- 應關閉水龍頭，以避免進水軟管破損或脫落，做成漏水事故的發生。

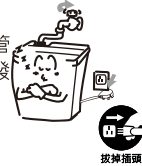

保養須知

使用軟布擦拭箱體上的水及污跡。

- 不要將水直接潑灑在箱體上，這樣做可能會做成短路或觸電。
- 不要使用刷子、上光粉、汽油或其他易揮發性材料擦拭洗衣機。這樣做可能會損壞機身表面塗層或塑料部件。



進水閥口的清理(建議半年一次)。

- 髒物積存會影響進水量，請取下進水軟管，取出進水閥口的過濾網，清除網上的髒物後重新裝回去。



接頭的清洗(建議半年一次)。

- 取下進水軟管。
- 按箭頭方向旋下接頭。
- 將清洗乾淨的接頭、進水軟管重新裝上。

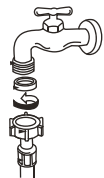

過濾網的清洗(建議每次使用後)。

- 取下過濾網。
- 去除大塊毛絨，同時刷去過濾網上細小絨屑。
- 重新裝上過濾網，安裝時將框部的爪對準下方的溝部放入。(過濾網為易損部件)



各部件名稱

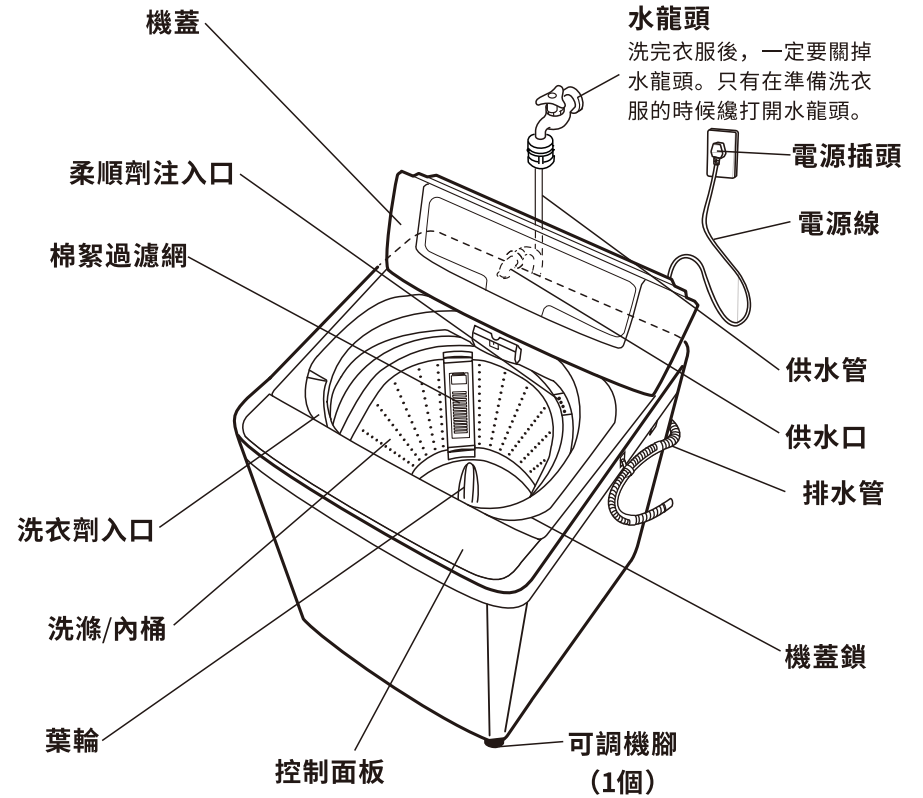

附件說明

說明書 (一本)	排水軟管組件 (一根)	進水軟管 (一根)	防鼠板 (一個)	螺釘 (一個)	保修卡 (一個)

安裝指引

防鼠板的安裝

1. 拿出洗衣機面架上的防鼠板和部件袋中的螺釘。
2. 將洗衣機向後傾斜，慢慢地放在軟墊上(小心不要磕碰箱體)。
3. 將防鼠板沿底托卡槽筆直推入，直到其安裝到位。
4. 用螺釘將防鼠板底托固定。
5. 將洗衣機輕輕扶起，放穩。

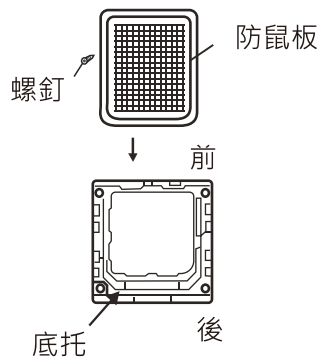

洗衣機的放置

1. 選擇乾燥、無陽光直射的地方放置洗衣機。
2. 將洗衣機安放在堅實、平穩的地面上。



傾斜的地面

不平穩的地面

3. 儘量使洗衣機平穩，如有必要，可通過調節洗衣機的可調腳來將洗衣機調平。
 - 支撐面最大允許傾斜度為2°。

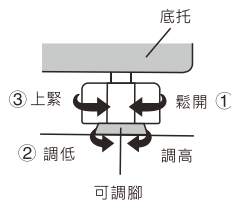

注意:

- 不要讓地毯等鋪墊物堵塞洗衣機底部的散熱孔。如把洗衣機安裝在地毯上，使用時可能會發生異常噪音、震動。

安裝指引

進水軟管的安裝

1. 請檢查密封圈是否良好的固定在軟管的接頭上。
2. 將進水軟管彎曲的一端連接在洗衣機的進水閥上，用手擰緊進水軟管上的旋緊螺母。
3. 將進水軟管直的一端連接在水龍頭上，並用手擰緊進水軟管上的旋緊螺母。
4. 打開水龍頭，檢查是否有漏水。如果水管的一端有漏水，請將那端的旋緊螺母擰緊。如果水壓比較大，請關閉水龍頭，然後再緩緩的打開。

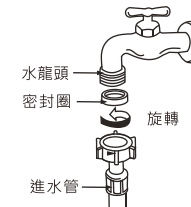

注意:

- 請不要使用水溫超過50°C的水。
- 如果您的水龍頭的水管不相配，請聯繫經銷商。

將進水軟管連接到洗衣機進水閥

按右圖所示，將進水軟管口對準進水閥口，順時針旋轉進水軟管上的旋緊螺母，直至旋不動為止。

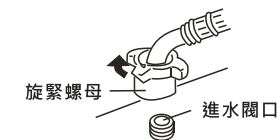

按右圖所示，進水閥上的進水軟管按逆時針方向旋轉，直至取下進水軟管。

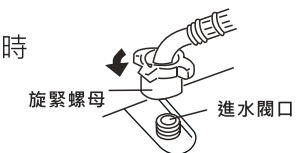

安裝指引

適用於高去水位安裝

排水軟管的安裝

1. 將排水管連接到箱體背後的排水接頭上。
2. 連接好後，請用軟管夾子將排水管夾緊，以免脫落。

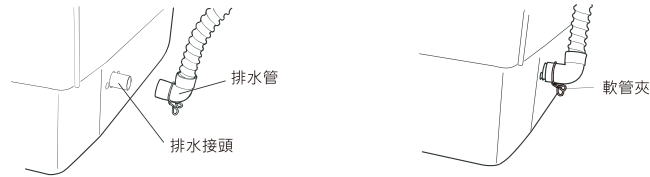

3. ①將排水管固定架插入孔中。
②按圖示方向旋轉90度，將固定腳旋入孔中。
4. 將排水管拉直，嵌入固定在排水管固定架上。

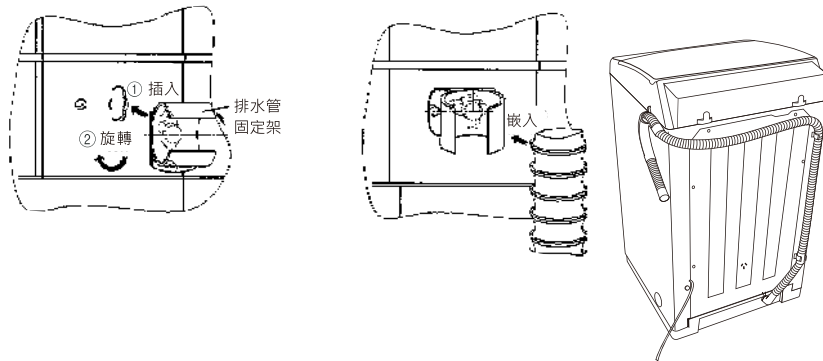

安裝指引

注意:

- 請勿將排水管放倒，以免水灑落。
- 請勿使用延長排水管。
- 請勿將排水管尾部的U型管浸在水中。
- 排水管安裝時，請勿低於排水接頭，如低於排水接頭可能會導致排水不順。

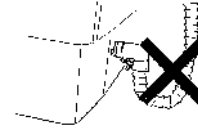

- 洗衣機操作時，排水軟管掛起的高度必須低於1000mm，否則洗衣機可能無法正常工作。

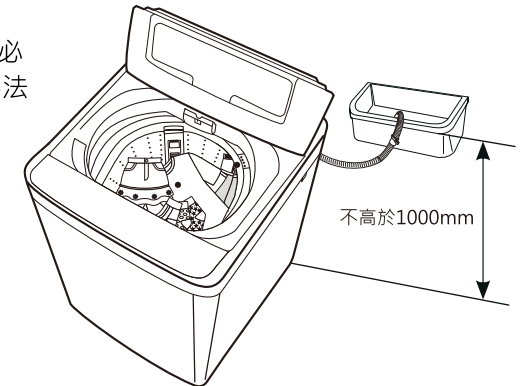

適用於低去水位安裝

排水軟管的安裝

1. 捏緊排水軟管夾子上的兩個柄，將排水軟管連接到排水泵口上(洗衣機後部)。然後用軟管夾子將其固定。

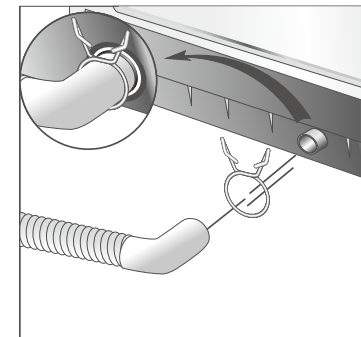

2. 將排水軟管另一端向上提起，按順序把排水軟管扣在洗衣機背部的卡扣內。
3. 使用洗衣機時，請將排水軟管口放在下水口。

控制面板

Air Jet Dry

脫水風乾衣物，負載1.5kg以下，固定耗時180分鐘。

程式

根據衣物上污漬的類型和程度選擇洗滌程序。
所選程序的指示燈亮起。

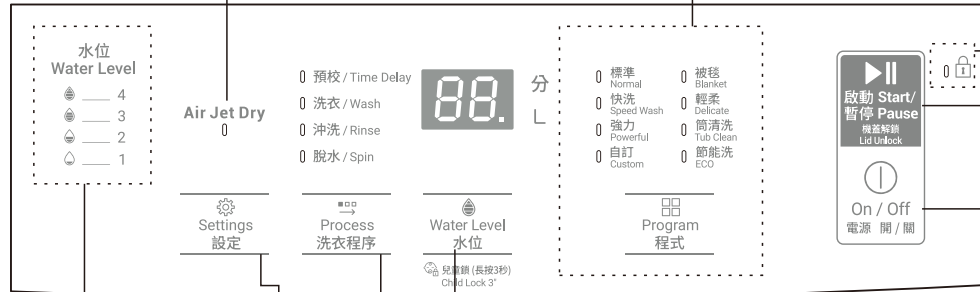

根據衣物的不同航臟程度，選擇不同的水位。

設定
按此鍵，設置“預校”“洗衣”“脫水”“Air Jet Dry”的時間，和“沖洗”的次數。

洗衣程序

- 按此鍵，對各個程式的過程參數進行選擇。
- 長按可設置排殘留水功能。

水位
按下此鍵選擇與洗衣量相對應的水位(1-4)
以下程序不能調節水位:「桶清洗」

電源開/關

要接通洗衣機電源，請按此鍵。如關閉電源，再按一次即可。如果您按下「電源開關」鍵後再沒有按壓其他鍵，電源將會在10分鐘內自動關閉。程序完成時，電源會在5秒之後自動關閉。

啟動/暫停

- 按此鍵“開始”程序
- 按此鍵暫停程序（再按一次可恢復）
- 解鎖機蓋鍵結束蜂鳴器。
- 長按可設置取消或恢復結束蜂鳴音。

指示上蓋是否被鎖

- 燈亮時：頂蓋已鎖定，無法打開。
- 燈閃爍時：鎖定程序正在進行中。
- 燈熄滅時：頂蓋已解鎖，可安全開啟。

一般的使用方法

1. 使用洗衣機事前準備及步驟。

- ① 接好並放下排水軟管。
- ② 將進水軟管接到水龍頭上，並擰開水龍頭。請確認進水管已擰緊。如果鬆動，可能會造成漏水。
- ③ 將電源插頭插入電源插座。
- ④ 放入衣物。

洗衣前準備事項

- 確保衣服口袋內沒有物品。(如釘子、硬幣等可能損傷衣服或洗衣機，產生額外的噪音或使洗衣機發生故障的東西。)
- 將衣服翻過來洗，這樣洗衣過程中產生的線屑不會附著在衣服表面。
- 當清洗纖細織物時，如女性內衣、飾有花邊的物品、尼龍和薄化纖衣料等，應將其放入洗滌用網套中。
- 繫緊衣服上鬆的帶子並拉上拉鏈，扣好鈕扣。
- 洗滌前先去除衣物上的泥土和沙。建議在洗較髒的外套前用刷子先洗刷一下。
- 易浮於水面之上的衣物，請放入水底，另外，浮上來時，請暫停並將其按入水中。
- 請將厚物與薄的衣物分開洗滌，有色衣物與白色衣物分開洗滌，外衣與內衣、毛巾等分開洗滌。

2. 根據需求將洗衣液或洗衣粉添加在洗衣劑盒或桶內。

3. 按下「電源開關」鍵，並選擇所需程序及功能。

4. 蓋好洗衣機上蓋並按下「啟動/暫停」鍵開始程序。

注意：

- 若使用柔順劑，可在洗衣前向柔順劑入口處倒入適量的柔順劑。
- 放入太多的洗衣劑，可能影響到過水性能，太少的洗衣劑可能影響到洗衣效果。
- 如洗衣機上蓋於運行時被打開，洗衣機將不能繼續運行並伴有蜂鳴提示。

一般的使用方法

洗衣劑及建議用量

水位	1	2	3	4
洗衣劑量提示				
粉末洗衣劑用量(g)	10~15	15~22	20~26	26~32
用水量	16L	27L	37L	45L
其他類型洗衣劑	按相應洗衣劑說明對照使用			

程序表

程序	最大洗滌容量	默認時間	默認參數					Air Jet Dry
			水位	浸泡/分鐘	洗滌/分鐘	漂洗/次	脫水/分鐘	
標準	額定容量	36~40分	默認:auto(2~4) 手動:1-4檔	—	8~9分 (0~15)可調	2 (0~3)可調	7分 (0~10)可調	●
快洗	≤3kg	10分(1檔) 28分(2檔) 31分(3-4檔)	默認:auto(2~4) 手動:1-4檔	—	3分(1-2檔) 6分(3-4檔) (0-15)可調	1次(1-2檔) 2次(3-4檔) (0-3)可調	2分(1-2檔) 5分(3-4檔) (0-10)可調	●
強力	額定容量70%	43~48分	默認:auto(2~4) 手動:1-4檔	—	11~12分 (0~15)可調	2 (0~3)可調	9分 (0~10)可調	●
自訂	額定容量	46~49分	默認:auto(2~4) 手動:1-4檔	—	13分 (0~15)可調	2 (0~3)可調	9分 (0~10)可調	●
被毯	毛毯<4.5kg	47分	默認:4 手動:3-4檔	—	12 (0~15)可調	2 (0~3)可調	8 (0~10)可調	○
輕柔	≤1.5kg	21~24分	默認:3 手動:2-4檔	—	4 (0~15)可調	2 (0~3)可調	1 (0~2)可調	○
筒清洗	0	11小時42分	默認:4檔	11小時	5	3	5	○
節能洗	額定容量	37分	默認:4 手動:1-4檔	—	12 (0~15)可調	2 (0~3)可調	4 (0~10)可調	●

- 實際程序時間會因不同因素如水壓、衣物的類型等而與上表所示有所不同。
- 如未按建議的洗衣量洗滌，可能無法達到預期的洗滌效果。
- 如調整選擇與預設不同的程序參數如洗滌時間、過水次數、功能等，程序時間將會有所調整。

●	預設無，可選
○	預設無，不可選

功能介紹及設定方法

預校時間

- 此功能用於預約從程序開始到結束的時間。預約時間可設定範圍為1-12小時。
- 在設定預校時間前，先接好並放下排水軟管，將進水軟管接到水龍頭上，並擰開水龍頭。請確認進水管接頭的螺釘已擰緊，避免漏水。

設定方法

1. 打開洗衣上蓋，按下「電源開關」鍵。
2. 放入衣物。
3. 根據需求選擇所需程序、功能及水位。
4. 按下“洗衣程序”鍵，“預校”燈閃爍，按“設定”鍵設定所需的預約時間（1-12小時）。
5. 將洗衣液或洗衣粉添加在洗衣劑盒或桶內。
6. 按下「啟動/暫停」鍵
 - 在大約1分鐘內，所有顯示燈（所選程序燈除外）將會熄滅。（如「兒童安全鎖」功能已啟用，相應提示燈亦會亮起。）
 - 如要查看已預約的程序，按下「設定」鍵即可，所需程序會顯示約5秒鐘。
 - 如要更改想預約的程序，關機並重新開機，然後重新設定。
 - 如拔下電源插頭或停電，預約功能將會被取消。

智能記憶

適應於標準、快洗、強力、自訂程序，在上次運行結束後，只需按放/停鍵即可記憶所選擇的程序，其中標準、快洗、強力程序不記憶人工設置，按默認程序運行，自訂程序可按照上次相同人工設置來運行。

雙重強力洗

為提高洗衣時的洗衣劑濃度，在洗衣過程中，洗衣機在達到比設定水位低兩檔水位時，進水同時開始洗滌。

- 此功能不適用於水位設定1及2。
- 此功能不適用於部分程序。

兒童鎖功能

當啟用此功能後，控制面板上所有按鍵即被鎖定，除了「電源開關」鍵以外，避免在運行期間不必要的操作，特別是當有兒童在附近時。

- 設定方法：按下「電源開關」鍵，按下「水位」鍵3秒直至聽到響聲，代表此功能已被啟用，取消時，重覆上述步驟。

功能介紹及設定方法

標準

適用於日常洗滌棉麻織物、混合衣物等。

快洗

適用於輕微污漬衣服的快速洗滌。

強力

適用於髒污嚴重的衣物（如工作服等）的洗滌。

自訂

適用於日常洗滌棉麻織物、混合衣物等，可記憶程序和參數。

被毯

適用於大件毛毯、棉毛類紡織品的洗滌。

輕柔

適用於精緻衣物輕柔洗滌。

筒清洗

以長時間洗滌來對內桶進行清洗。

節能洗

適用於棉質、棉麻衣物的洗滌，此程序屬能源標籤參考程序。

故障排除指南

當下列問題出現時，微電腦將對不正常狀態進行檢測，並發出大約10秒鐘的蜂鳴提示，數碼窗將按下表所示狀態閃爍。同時，洗衣機會停止運作。

顯示	需要檢查的問題	解決方案
E1 不進水	<ul style="list-style-type: none"> · 水龍頭開了嗎？ · 進水網是否被異物堵塞？ · 它凍住了嗎？ · 是否有水泄露？ · 是否有使用井水？ 	在點檢後， 按兩次暫停 (再次運行)
E2 不排水	<ul style="list-style-type: none"> · 請調整一下排水管。你是忘了把它放平還是壓壞了？ · 中部是否升高超過15厘米？ · 排水口堵塞了嗎？ · 排水管（過濾器或疏水閥）是否被螺紋堵塞？ 	
U3 不脫水	<ul style="list-style-type: none"> · 衣服都歪到一邊了嗎？ · 這臺機器是傾斜還是搖晃？ 	
E:41,42, 43,44	<p>頂蓋鎖緊是否例外？ 頂蓋是否安全關閉？ 在沖洗、脫水、筒清洗時， 或在啟用兒童鎖功能時有否強行打開上蓋？ 旋轉、乾燥。或者在浴缸清潔功能或兒童鎖設置時？ 如果檢查後問題仍然存在，會顯示E41, E42, E43, E44 可能導致頂蓋機構損壞。 請把電源線從插座上拔下來，關掉水龍頭， 並儘快送到您購買的商店修理。</p>	
U4	不運轉（暫停） 上蓋打開了嗎？	蓋上頂蓋
Ud	操作后顯示是否進行了防凍設置（以排出殘留的水）？	
UL	童鎖功能設置了嗎？ 上蓋打開了嗎？	
EA EU etc.	需要對控制部件進行調整以進行修理。請先將電源線從插座上拔出， 關閉水龍頭，然後儘快聯絡您購買該物品的商店進行維修。 請將電源線從插座上拔下，關閉水龍頭，並儘快將其帶到您購買的商店維修。	

注意：按「啟動/暫停」鍵，故障顯示會被解除。如您檢查各項並排除故障後，再按「啟動/暫停」鍵，洗衣機將繼續運作。

並非故障的情況

1. 主洗或過水時，有時有進水現象，這是水位下降而進行的自動補水。
2. 在脫水開始時，脫水桶時停時轉，這是為達到更好的脫水效果而設計的間歇脫水。
3. 脫水中途有時出現進水及過水現象，這是由於脫水時衣物偏置，而自動進行的脫偏糾正。
4. 脫水結束後，有水殘留的聲音，這是為了降低脫水震動而設計的平衡環內平衡液的流動聲。
5. 在運轉後按下「電源開關」鍵關機，控制板部份仍可以感覺到輕微發熱，這是由於記憶電路電子部件發熱造成的。
6. 程序運行中停電，來電後不能繼續運行，請重新設定。

SPECIFICATIONS

規格

Dimensions	500(W)x535(D)x850(H)mm
尺寸	(闊) (深) (高)
Weight	29kg
重量	
Water quantity (HIGH)	45L
水量(高水位)	
Voltage	AC 220V ~ 50Hz
額定電壓/頻率	
Input Power	330W
額定輸入功率	
Required Water Pressure	0.03 MPa – 0.8 MPa
水壓	

FOR WASHER WITH A 13 Amp. PLUG TOP 3 PIN

對於附有13安培三腳插頭的洗衣機

WARNING - This appliance must be earthed.

警告-本電器必須接地。

IMPORTANT

The wires in this mains lead are coloured in accordance with the following code:

Green/Yellow: Earth
Blue: Neutral
Brown: Live

As the colours of the wires in the mains lead of this appliance may not correspond with the coloured markings identifying the terminals in your plug, proceed as follows:

The wire which is coloured green and yellow must be connected to the terminal in the plug which is marked with the letter E or by the earth symbol , or coloured green or green and yellow.

The wire which is coloured blue must be connected to the terminal which is marked with the letter N or coloured black.

The wire which is coloured brown must be connected to the terminal which is marked with the letter L or coloured red.

重要事項

電源線的電源是根據以下的顏色表示:

綠 黃：地線
藍：中性線
棕：火線

由於本電器電源線的顏色不一定和您的插頭終端上的顏色標誌相同,所以應該採取以下步驟:

綠黃色電源線應該連接至插頭上標明英文字母E或地線符號或顏色是綠色或黃綠色的終端。

藍色電源線應該連接至插頭上標明英文字母N或顏色是黑色的終端。

棕色電源線應該連接至插頭上標明英文字母L或顏色是紅色的終端。