



INSTRUCTIONS

⚠ WARNING: READ AND UNDERSTAND ALL INSTRUCTIONS.

Failure to follow all instructions listed below may result in electric shock, fire and/or serious personal injury.

⚠ WARNING: ELECTRIC PRODUCT. Keep away from children. Not recommended for children under 3 years of age. As with all electrical products, precautions should be observed during handling and use to reduce the risk of electric shock. If the supply cord is damaged, it must be replaced by the manufacturer, its service agent or similarly qualified persons in order to avoid a hazard. To avoid the risk of electrical shock, always make sure the product is unplugged from the electrical outlet before assembling, disassembling, or relocating.

⚠ WARNING: This product is to be assembled by adults only.

IMPORTANT SAFETY INSTRUCTIONS WHEN USING ELECTRICAL PRODUCTS, BASIC PRECAUTIONS SHOULD ALWAYS BE FOLLOWED INCLUDING THE FOLLOWING:

READ AND FOLLOW ALL SAFETY INSTRUCTIONS.

1. This is an electrical product - not a toy! To avoid risk of fire, burns, personal injury, and electric shock, it should not be played with or placed where small children can reach it.
2. Do not use seasonal products outdoors unless marked suitable for indoor and outdoor use. When products are used in outdoor applications, connect the product to a Ground Fault Circuit Interrupting (GFCI) outlet. If one is not provided, contact a qualified electrician for proper installation.
3. This seasonal use product is not intended for permanent installation or use.
4. Do not mount or place near gas or electric heaters, fireplaces, candles, or other similar sources of heat.
5. Do not secure product wiring with staples or nails or place on sharp hooks or nails.
6. Do not let lamps rest on the supply cord or on any wire.
7. This product is equipped with push-in type lamps. Do not twist lamps.
8. Unplug the product when leaving the house, when retiring for the night, or if left unattended.
9. Do not use this product for other than its intended purpose.
10. Do not hang ornaments or other objects from cord, wire, or light string.
11. Do not close doors or windows on the product, or extension cords, as this may damage the wire insulation.
12. Do not cover the product with a cloth, paper, or any material not part of the product when in use.
13. Do not place the product against carpeting, furniture, or any other fabric when in use.
14. This product employs overload protection (fuse). A blown fuse indicates an overload or a short-circuit condition. If the fuse blows, unplug the product from the outlet. Also unplug any additional string or products that may be attached to the product. Replace the fuse as per the user servicing instructions (follow product markings for proper fuse rating) and check the product. If replacement fuse blows, a short-circuit may be present and the product should be discarded.
15. Read and follow all instructions that are on the product or provided with the product.

SAVE THESE INSTRUCTIONS USE AND CARE INSTRUCTIONS

1. Before using and reusing, inspect the product carefully. Discard any products that have cut, damaged or frayed wire insulation cords, cracks in the lampholders or enclosures, loose connections, or exposed copper wire.
2. When not in use, store carefully in a cool, dry location protected from sunlight.

Congratulations! You're the proud owner of your very own Glimmer™ Ornament Archway from Gemmy! Below, we hope you'll find the answers to many questions, and how to get maximum enjoyment from it for years to come!

Please read over the directions carefully before installing and operating this item. Some assembly is required.

CONTENTS

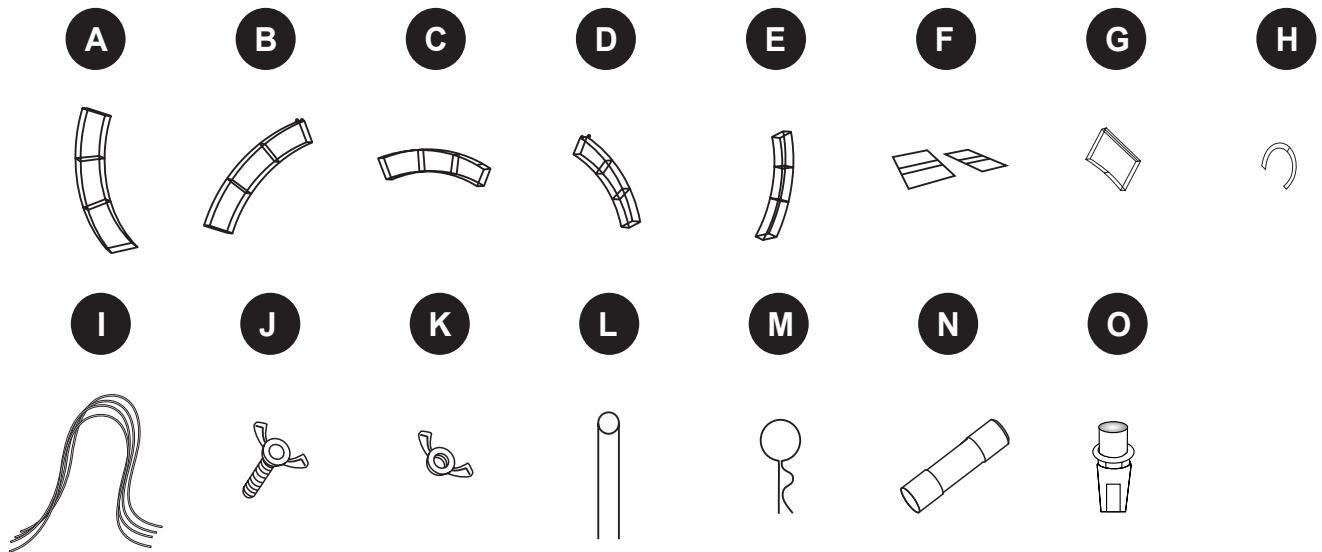

PART	DESCRIPTION	QUANTITY	PART	DESCRIPTION	QUANTITY
A	Arch 1	1	I	Cording	4
B	Arch 2	1	J	Screws	18
C	Arch 3	1	K	Nuts	12
D	Arch 4	1	L	Yard Stakes	10
E	Arch 5	1	M	Cotter Pins	4
F	Base Support Frames	2	N	Extra Fuse 3A, 125V	1
G	Ornament Topper	1	O	Extra Lamps	2
H	Ornament Hook	1			

ASSEMBLY INSTRUCTIONS

PRO TIPS: Assemble the Lighted Glimmer™ Ornament Archway near or in the desired display location. Read through instructions before assembling. If possible, assemble the Ornament Archway with two people.

1. **CONNECT ARCHWAY PIECES:** Carefully remove contents from the box and lay flat on the ground. Arrange archway pieces (A,B,C,D,E) in order and begin assembling the archway flat on the ground (you may also assemble upright, if preferred). Using the included screws (J), attach arch 1 (A) to arch 2 (B). Attach assembled arches 1 and 2 (A,B) to arch 3 (C). Attach assembled arches 1, 2 and 3 (A,B,C) to arch 4 (D). Attach assembled arches 1, 2, 3 and 4 (A,B,C,D) to arch 5 (E). See illustration 1

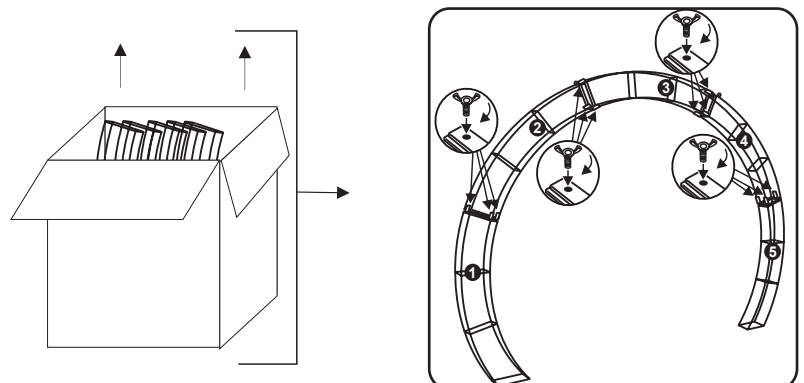

Illustration 1

2. ATTACH DECORATIVE TOPPER: Using the included screws (J), attach the ornament topper (G) to assembled arches 3 and 4 (C,D). Next, attach the ornament hook (H) to the ornament topper (G). See illustration 2.

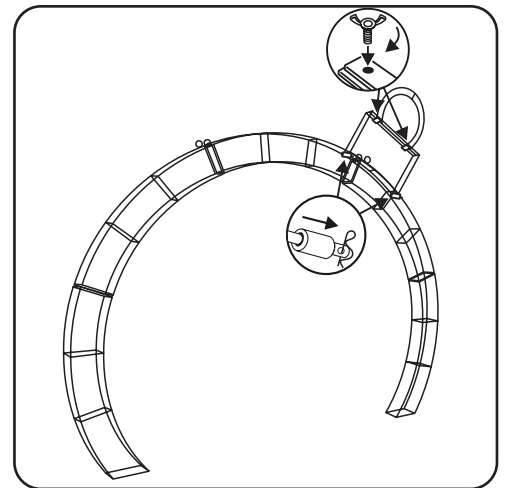

Illustration 2

3. ATTACH CORDS TO TOP: Locate the 4 iron rings at the top of the assembled archway. Using the included cords (I), tie one end of each cord to each of the iron rings. See illustration 3.

4. ATTACH BASE SUPPORT FRAMES: Next, attach the base support frames (F) to the bottoms of arch 1 (A) and arch 5 (E). The easiest method is to place the base support frames (F) in the desired display location. While still flat on the ground, move the bottoms of arch 1 (A) and arch 5 (E) next to each support frame. Raise the Ornament Archway onto the support frames. Using the included nuts (K), secure the bottoms of arch 1 (A) and arch 5 (E) to the base support frames (F). See illustration 3.

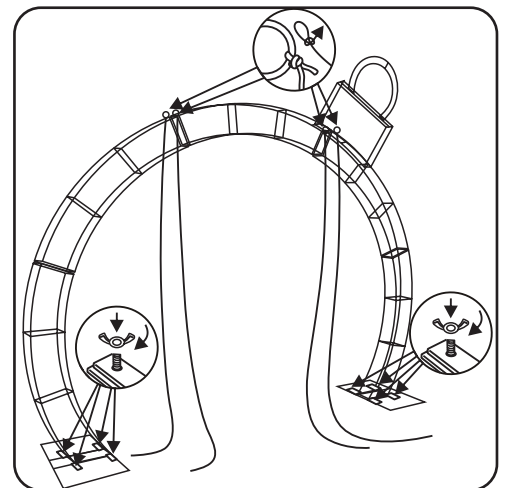

Illustration 3

5. SECURE TO GROUND: Make any final adjustments on where you would like to display the Lighted Glimmer™ Ornament Archway. Insert the yard stakes (L) into the base support frames (F) and secure into the ground. Tie the loose ends of the two cords on the left (I), to yard stakes on the left (L) and tighten. Repeat on the right side. See illustration 4.

6. PLUG IN: Plug in your assembled and secured Lighted Glimmer™ Ornament Archway to an AC outlet and enjoy!

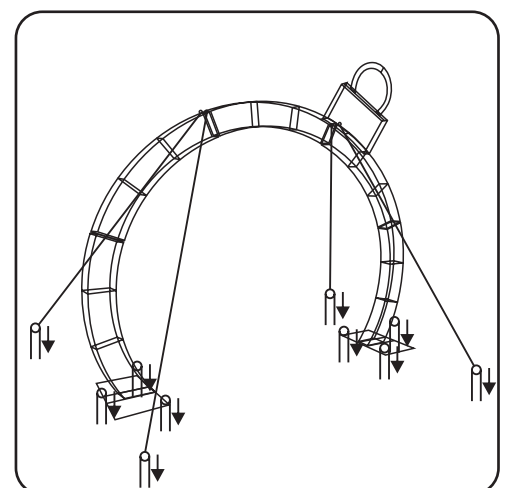

Illustration 4

CAUTION: The frame straps (Plastic ties) should not be placed around any conductor wire during assembly!

Disassembly Instructions --- Please refer to assembly instruction above, but in reverse order.

Approximate Assembly time: 10-15 minutes.

USER SERVICING INSTRUCTIONS

Fuse Replacement

WARNING: Risk of Fire: Replace fuse only with 3 Amp Max, 125 Volt fuse (provided with product).

WARNING: Risk of Fire: Do not replace the attachment plug. It contains a safety device (fuse) that should not be removed. Discard product if attachment plug is damaged.

1. Grasp plug and remove from the receptacle or other outlet device. Do not unplug by pulling on the cord.
2. Open fuse cover. Slide open the fuse access cover on top of the attachment plug towards blades (see illustration).
3. Remove fuse carefully.
4. Replace fuse only with same size and type of fuse.
5. Close the fuse cover. Slide closed the fuse access cover on top of the attachment plug.

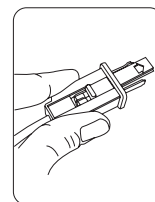

To replace lamp:

1. Grasp plug and remove from the receptacle or other outlet device. Do not unplug by pulling on cord.
2. Pull lamp and plastic base straight out of lampholder.
3. Replace lamp with 4.5 Volt, 0.14 Watt flashing lamps or 3.0 Volt, 0.06 Watt steady lamps (provided with product). If the new lamp base does not fit in lampholder, follow the steps below before step 3.

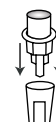
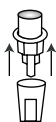
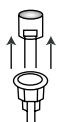

- a. Remove the base of burned out lamp by straightening lamp leads and gently pull lamp out.
- b. Thread leads of new lamp through holes in old base with one lead in each hole.
- c. After lamp is fully inserted into base, bend each lead up, like other lamps in the light set so that the leads will touch the contacts inside the lampholder.
4. The lamp base of the individually-flashing lamps is not intended to be exchanged with another lamp.

CAUTION

1. Risk of fire. This product does not contain lamp shunts; it cannot operate if one lamp burns out. Do not replace lamps with lamps other than the spare lamps provided with this product.
2. To reduce the risk of fire and electric shock: a) Do not install on trees having needles, leaves or branch coverings of metal or materials which look like metal. b) Do not mount or support strings in a manner that can cut or damage wire insulation.

CAUTION

1. This product contains lamps of two different sizes. To reduce the risk of overheating do not replace steady illuminating lamps with flashing lamps.
2. Use 4.5 Volt, 0.14 Watt flashing lamps or 3.0 Volt, 0.06 Watt steady lamps.

WARNING

Strobe lights have been known to trigger seizures in people with photosensitive epilepsy. Do not remove light string from the product and hang on trees or other places for decoration.

STORAGE

Do not discard the box, it can be used to store the product. Store in a cool, dry location.

TROUBLESHOOTING CHECKLIST

If the item is not operating, the problem may be:

1. The power source is disabled or the cord is unplugged.

NOTE: ONCE THE ITEM IS UNPLUGGED, THE PRODUCT WILL CEASE OPERATION.

Fuse Replacement

WARNING: Risk of Fire: Replace only with the same size and type of fuse.

Do not replace the attachment plug. It contains a safety device (a fuse) that should not be removed. Discard product if the attachment plug is damaged.

1. Grasp the plug and remove from the receptacle or other outlet device. Do not unplug by pulling on the cord.
2. Open fuse cover. Slide the fuse access cover open, which is located on top of the attachment plug towards the blades (see illustration).
3. Remove fuse carefully.
4. Replace fuse only with 3 Amp Max, 125 Volt fuse provided with product.
5. Close the fuse cover.

Lamp Replacement

Replace lamps only with LED type spare lamps provided with this product.

1. Locate the non-working lamp and pull to remove from base (unsnap base, if needed).
2. Insert new lamp into base and gently push into place.
3. Properly discard old lamp.

FREQUENTLY ASKED QUESTIONS (FAQs)

1. *Can I leave it running overnight?*

We recommend that you turn off while unattended. Extended use beyond 8 hours will not damage this item.

2. *How much electricity does it use?*

Please refer to the tag attached to the power cord.

3. *What is the best way to store it?*

Store dry in a bag, box or other storage container and keep in a cool, dry location.

4. *My area is prone to unusually windy conditions, will this affect the product?*

In order to prevent damage, we suggest you keep the product protected from high winds by simply relocating the item to a sheltered area until wind conditions improve.

5. *What if it is raining or snowing? Will this affect the product?*

Operation in light weather conditions, such as a gentle rain or snowfall is fine.

6. *I have extra plastic Ties. What are these for?*

You may use these to further secure the product as desired.

WARNING

This device complies with Part 15 of the FCC Rules. Operation is subject to the following two conditions: (1) this device may not cause harmful interference, and (2) this device must accept any interference received, including interference that may cause undesired operation.

CAUTION: Changes or modifications not expressly approved by the party responsible for compliance could void the user's authority to operate the equipment.

NOTE: This equipment has been tested and found to comply with the limits for a Class B digital device, pursuant to Part 15 of the FCC Rules. These limits are designed to provide reasonable protection against harmful interference in a residential installation. This equipment generates, uses, and can radiate radio frequency energy and, if not installed and used in accordance with the instructions, may cause harmful interference to radio communications. However, there is no guarantee that interference will not occur in a particular installation. If this equipment does cause harmful interference to radio or television reception, which can be determined by turning the equipment off and on, the user is encouraged to try to correct the interference by one or more of the following measures:

- Reorient or relocate the receiving antenna.
- Increase the distance between the equipment and receiver.
- Connect the equipment into an outlet on a circuit different from that to which the receiver is connected.
- Consult the dealer or an experienced radio/TV technician for help.

THESE INSTRUCTIONS ARE FOR ITEM NUMBER

SKU #: 1007613144

Model #: 22GM13688

MADE IN CHINA
PRINTED IN CHINA
DISTRIBUTED BY:
HOME DEPOT
2455 PACES FERRY RD., N.W.
ATLANTA, GA 30339
FOR ASSISTANCE, CALL:
1-855-HDHOLIDAY (1-855-434-6543)
HOURS OF OPERATION ARE
MON-FRI 8AM-7PM AND SAT 9AM-6PM EST
HOMEACCENTSHOLIDAY.COM