



SKU # 1007 599 755  
Model # 22RT1492211

# ASSEMBLY INSTRUCTIONS

## 7ft Nativity TWINKLING LED Nativity Scene

### USE AND CARE GUIDE

#### PLANNING ASSEMBLY

Carefully remove all the parts from the box and place them on the ground. Many parts are connected by the lighting string that runs throughout the item. Take special care not to pull, cut or damage the lighting string. Read the entire manual prior to assembly and identify all the parts included in the package against the parts list. It is recommended to assemble parts of the product while laying flat on the ground versus standing the item up to assemble the parts. If any parts are missing or damaged do not attempt assembly but contact our customer service center or return to place of purchase with purchase receipt.

Assembly of this product may require more than one person.  
1-855-HDHoliday (1-855-434-6543 )

#### Pre-Operation

**CAUTION:** Grasp the plug to insert or remove from the power source. Do not unplug by pulling on cord.

**CAUTION:** The lighting string on this product is rated at 26.4 Watts (0.22 Amps). Do not overload. Do not connect to another lighting string, decorative outfit or other electrical products. Before you use or re-use this product inspect it carefully. Discard or return to place of purchase with purchase receipt if the product has cuts, damage, frayed wire insulation on cords, cracks in the socket enclosures, loose connections, exposed copper wire or other obvious damage.

#### Care and Cleaning

- Carefully remove the product from wherever it is placed. This helps to avoid any undue strain or stress on the product connections, and wires. If the product is placed somewhere other than the ground it should be well secured, flat and stable.
- Carefully disassemble the unit taking caution not to cut any electrical wires.
- Wipe the unit with a damp cloth and allow the unit to dry before storing.
- Store the product neatly in a cool, dry location protected from sunlight.

#### Troubleshooting

- Ensure that the ground or surface that the item sits on is flat and level
- Be sure to plug the item correctly to a wall outlet or a UL Listed Power Cord
- Ensure all parts are assembled properly per the Instruction Manual
- If the item does not light check for loose or broken bulbs and connections
- Do not plug into other electrical items
- If the item has multiple Light String Cords be sure to plug in all cords
- Check for Broken or Burned Out Fuse In Plug

### Guarantee

#### What is Covered

The product is intended for residential seasonal use for 90 days maximum per year. This product is covered by a 90 days limited guarantee due to defects in material and workmanship. Return the product with purchase receipts to the location of purchase for refund within 90 days of purchase.

#### What is Not Covered

This warranty does not cover commercial use, normal wear and tear, products not used in accordance with directions provided on or with the product, burn out of bulbs or LEDs, batteries, products that have been subjected to unauthorized repair and/or modification and damage caused by shipping and improper handling, alterations, misuse, in store display models or accidents. Questions, problems, missing parts? Before returning to the store, call Home Accents Holiday Customer Service 8 a.m.-6 p.m., EST, Monday-Friday 1-855-HDHoliday (1-855-434-6543)

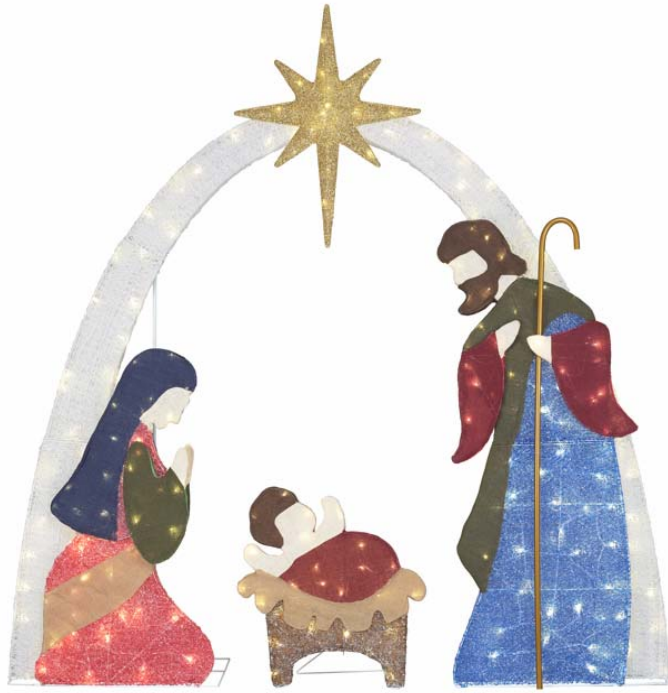

#### Thank you!

We appreciate the trust and confidence you have placed in Home Accents through the purchase of this 7ft Nativity TWINKLING LED Nativity Scene. We strive to continually create quality products designed to enhance your home. Visit us online to see our full line of products available for your home improvement needs. Thank you for choosing Home Accents!

**1-855-HDHoliday (1-855-434-6543)**  
**HOMEACCENTSHOLIDAY.COM**

Parts List		
Locater	Name	Qty.
A	Star	1
B	Top of Stable	2
C	Middle Section of Stable	2
D	Lower Section of Stable	2
E	Stable Support Bar	4
F1	Left Base Stand	1
F2	Right Base Stand	1
G	Half of Cane	2
H	Mary's Head / Upper Body	1
I	Mary's Lower Body	1
J	Mary's Arm	2
K	Joseph's Head	1
L	Joseph's Upper Body	1
M	Joseph's Lower Body	1
N	Joseph's Arm	2
O	Baby / Quilt	1
P	Baby's Bed	1
Q	Support Bracket of Baby's Bed	1

Hardware List		
Locater	Name	Qty.
R	Spare Bulb	10
S	Spare Fuse	8
T	Cotter Pin	7
U	Plastic Tie	15
V	Bolt & Wingnut	12
W	Ground Stake	14
X	Anchor String	4

#### Diagram of Parts

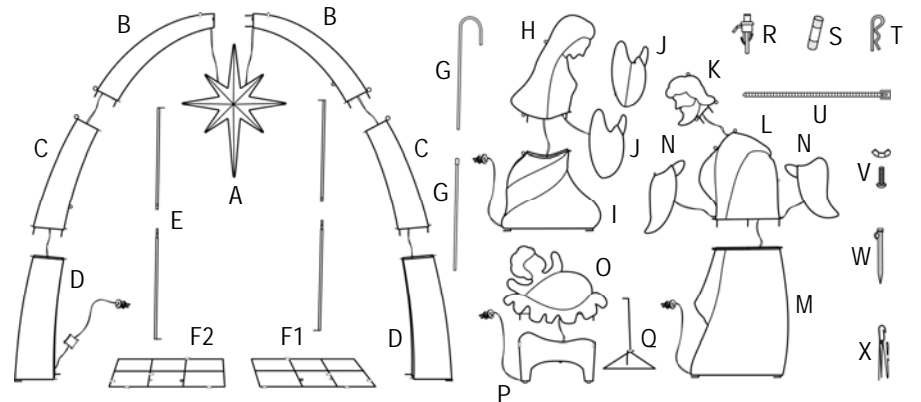

# ASSEMBLY

## 1 Assembling the Stable

Insert the connecting rods on the bottom of each Middle Section of Stable (C) into the matching connecting holes on the top of each Lower Section of Stable (D). Insert the connecting rods on the bottom of each Top of Stable (B), {make sure the columns and roof are positioned with the front side out} into the connecting hole on the top of each Middle Section of Stable (C). Use the Bolt & Wingnuts (V) to secure at the connecting loops. Align the two sections of the Top of Stable (B) together and insert the connecting rods on one side into the matching connecting holes on the other side and fasten at the connecting loops with Plastic Tie (U). Insert the connecting rods on the Star (A) into the matching connecting holes on the Top of Stable (B).

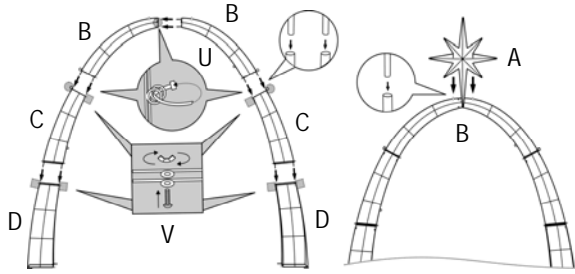

## 2 Assembling the Base Stand

Insert the connecting rods at the bottom of the Left & Right Lower Sections of Stable (D) into the matching connecting holes on the Left and Right Stable Base Stand (F1&F2) and fasten them with Bolt & Wingnuts (V).

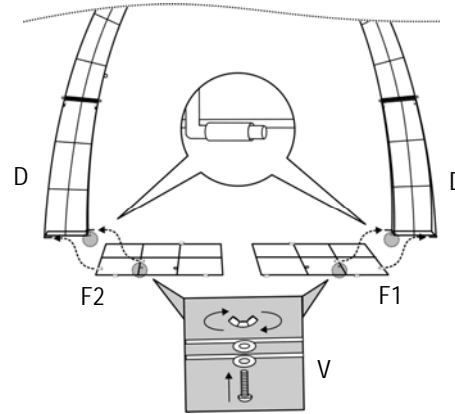

## 3 Assembling the Stable Support Bars to the Stable

Stack and lock the two segments of the Stable Support Bar (E). Insert each hooked end of the Stable Support Bar (E) into the matching holes on the Left & Right back side of the Middle Section of Stable and the Left and Right Stable Base Stand (F1&F2) then secure with the Cotter Pins (T).

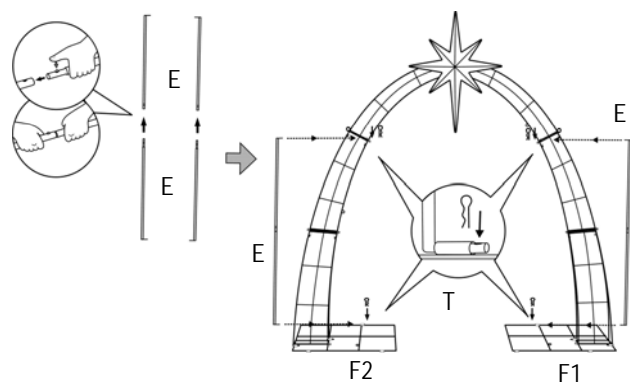

## 4 Assembling Mary's Body and Arm

Insert the connecting rods on the bottom of Mary's Upper Body (H) into the matching connecting holes on the Top of Mary's Lower Body (I). Insert the connecting rods on Mary's Arms (J) into the matching connecting holes on Mary's Body. Fasten the parts together with the Plastic Ties (U) at the connecting loops.

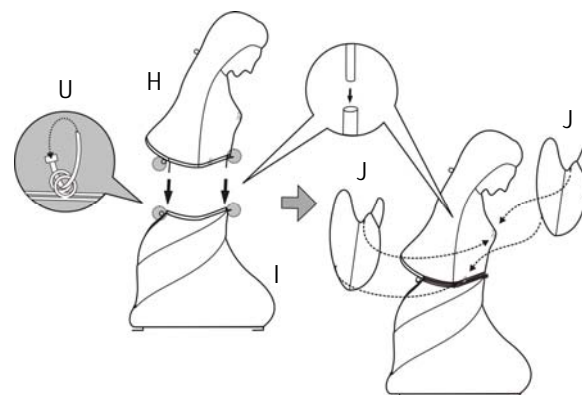

## 5 Assembling Joseph's Head, Body and Arms

Insert the connecting rods on the bottom of Joseph's Upper Body (L) into the matching connecting holes on the top of Joseph's Lower Body (M). Insert the connecting rods on the bottom of Joseph's Head (K) into the matching connecting holes on the top of Joseph's Upper Body (L). Insert the connecting rods on Joseph's Arms (N) into the matching connecting holes of Joseph's Body. Fasten at the connecting loops with Plastic Ties (U).

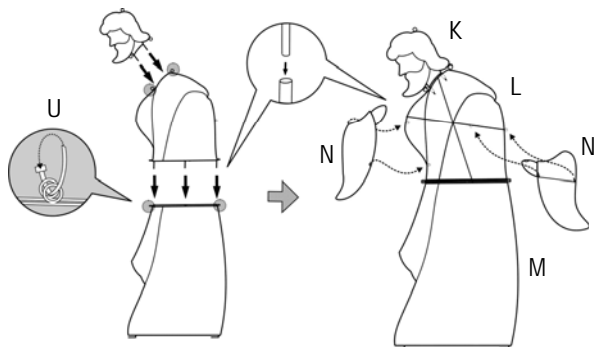

## 6 Assembling Joseph and Mary to the Stable

Insert the connecting rods on the bottom of Mary's Body into the matching connecting holes on the Right Stable Base Stand (F2). Insert the connecting rods on the bottom of Joseph's Body into the matching connecting holes on the Left Base Stand (F1). Secure Mary and Joseph to the Stable at the connecting loops shown in the diagram with Plastic Ties (U). Assemble the two sections of Joseph's Cane (G) then place the Cane through the hole in Joseph's left hand and let the bottom of the Cane rest on the ground.

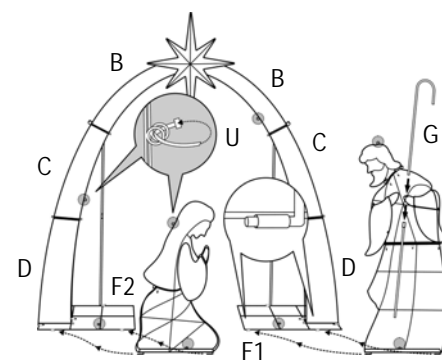

## 7 Assembling the Baby to the Bed

Insert the connecting rods on the bottom of Baby / Quilt (O) into the matching connecting holes on the top of Baby's Bed (P). Insert the connecting rods on Support Bracket of Baby's Bed (Q) into the matching holes on Baby's Left Arm and Bed and lock with Cotter Pin (T).

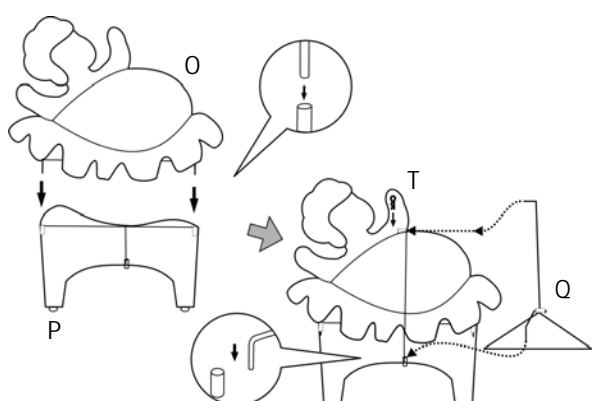

## 8 Securing the Nativity Scene to the Ground

Hook the plastic clipped end of each Anchoring String (X) onto the matching loop at the top of the Middle Section of Stable. Attach the looped free end of the Anchoring String to the hook on the Ground Stake (W) then pull each Anchoring String with the Ground Stake out and away from the Nativity evenly and secure to the ground. With the remaining Ground Stakes place them over the metal Base Frames of Joseph, Mary, Baby's Bed and Stable then into the ground firmly.

