

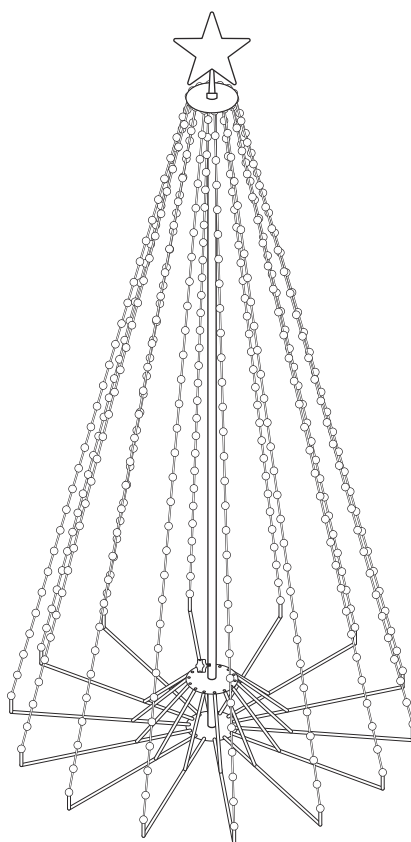

Item #1007-578-768
Model #22KY10004
ETL Model #JY-CNT0355-15

USE AND CARE GUIDE

8FT GIANT SIZED LED PRE-LIT CONE TREE WITH STAR AND TIMER



Questions, problems, missing parts? Before returning to the store,
call Home Accents Customer Service
8 a.m. - 7 p.m., EST, Monday-Friday, 9 a.m. - 6 p.m., EST, Saturday

1-855-HD-HOLIDAY

HOMEDEPOT.COM

THANK YOU

We appreciate the trust and confidence you have placed in Home Accents through the purchase of this lighted tree. We strive to continually create quality products designed to enhance your home. Visit us online to see our full line of products available for your home improvement needs. Thank you for choosing Home Accents!

Table of Contents

Safety Information 2
Pre-Assembly 3
 Planning Assembly. 3
 Package Contents 3
Assembly. 4

Remote Control Operations 6
Care and Cleaning 7
Troubleshooting 7
Warranty 7

Safety Information

IMPORTANT SAFETY INSTRUCTIONS

When using electrical products, basic precautions should always be followed including the following:

1. READ AND FOLLOW ALL SAFETY INSTRUCTIONS.

2. Do not use seasonal products outdoors unless marked suitable for indoor and outdoor use. When products are used in outdoor applications, connect the product to a Ground Fault Circuit Interrupting (GFCI) outlet. If one is not provided, contact a qualified electrician for proper installation.
3. This seasonal use product is not intended for permanent installation or use.
4. Do not mount or place near gas or electric heaters, fireplaces, candles or other similar sources of heat.
5. Do not secure the wiring of the product with staples or nails, or place on sharp hooks or nails.
6. Do not let lamps rest on the supply cord or on any wire.
7. Unplug the product when leaving the house, or when retiring for the night, or if left unattended.
8. This is an electric product – not a toy! To avoid risk of fire, burns, personal injury and electric shock it should not be played with or placed where small children can reach it.
9. Do not use this product for other than its intended use.
10. Do not hang ornaments or other objects from cord, wire, or light string.
11. Do not cover the product with cloth, paper or any material not part of the product when in use.
12. Do not close doors or windows on the product or extension cords as this may damage the wire insulation.
13. Read and follow all instructions that are on the product or provided with the product.

14. SAVE THESE INSTRUCTIONS.

Use and care instructions

- a) When the product is placed on a live tree, the tree should be well maintained and fresh. Do not place on live trees in which the needles are brown or break off easily. Keep the live tree holder filled with water.
- b) If the product is placed on a tree, the tree should be well secured and stable.
- c) Before using or reusing, inspect product carefully. Discard any products that have cut, damaged, or frayed wire insulation or cords, cracks in the lampholders or enclosures, loose connections, or exposed copper wire.
- d) When storing the product, carefully remove the product from wherever it is placed, including trees, branches, or bushes, to avoid any undue strain or stress on the product conductors, connections, and wires.
- e) When not in use, store neatly in a cool, dry location protected from sunlight.

CAUTION

1. To reduce the risk of electric shock, do not attempt to replace lamps or modify string.
 2. To reduce the risk of fire and electric shock:
 - a) Do not install on trees having needles, leaves or branch coverings of metal or materials which look like metal, and
 - b) Do not mount or support strings in a manner that can cut or damage wire insulation
- Model #22KY10004
ETL Model #JY-CNT0355-15

 **WARNING:** This device complies with Part 15 of the FCC Rules. Operation is subject to the following two conditions (1) this device may not cause harmful interference, and (2) this device must accept any interference received, including interference that may cause undesired operation.

 **CAUTION:** To reduce the risk of electric shock, do not attempt to replace lamps or modify string.

 **CAUTION:** To reduce the risk of fire and electric shock:

- Do not install on trees having needles, leaves or branch coverings of metal or materials which look like metal.
- Do not mount or support strings in a manner that can cut or damage wire insulation.

 **CAUTION:** Changes or modifications not expressly approved by the party responsible for compliance could void the user's authority to operate the equipment.

 **NOTE:** This equipment has been tested and found to comply with the limits for a Class B digital device, pursuant to part 15 of the FCC Rules. These limits are designed to provide reasonable protection against harmful interference in a residential installation. This equipment generates, uses and can radiate radio frequency energy and, if not installed and used in accordance with the instructions, may cause harmful interference to radio communications. However, there is no guarantee that interference will not occur in a particular installation. If this equipment does cause harmful interference to radio or television reception, which can be determined by turning the equipment off and on, the user is encouraged to try to correct the interference by one or more of the following measures:

- Reorient or relocate the receiving antenna.
- Increase the separation between the equipment and receiver.
- Connect the equipment into an outlet on a circuit different from that to which the receiver is connected.
- Consult the dealer or an experienced radio/TV technician for help.

FCC Responsible Party: The Home Depot
2455 Paces Ferry Road
Atlanta, Georgia
1-855-HD-HOLIDAY

Pre-Assembly

PLANNING ASSEMBLY

Carefully remove all packing materials and contents. Compare all parts with the Package Contents list. If any part appears missing or damaged, do not assemble and use this product. Contact Customer Service at 1-855-HD-HOLIDAY.

PACKAGE CONTENTS

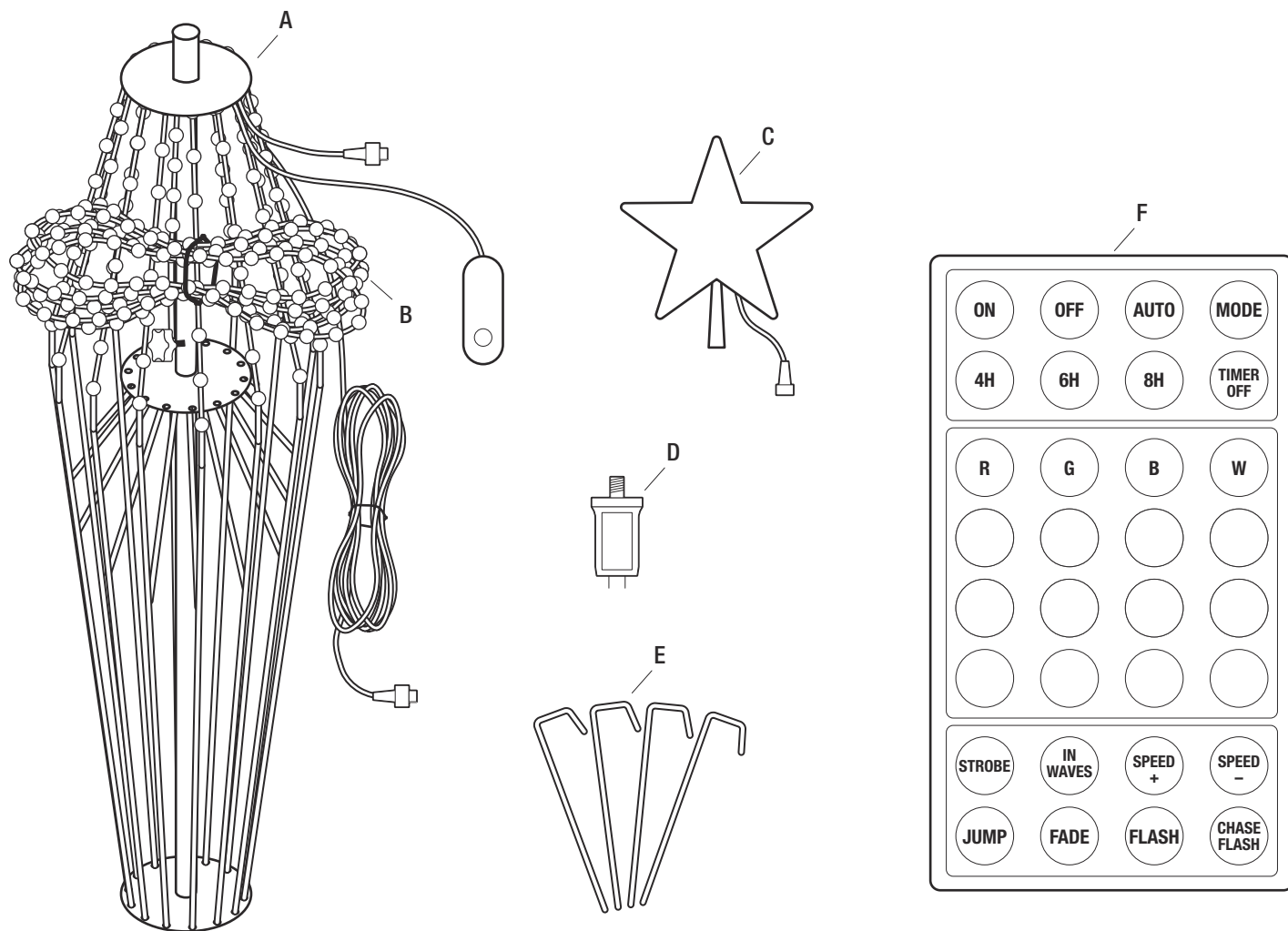

Part	Description	Quantity
A	Collapsible tree frame with telescopic pole	1
B	15-string light bundle with controller box	1
C	Star topper	1
D	Power adapter	1
E	Ground stakes	4
F	Remote control	1

Assembly

1 Preparing the Tree

- Remove collapsed tree (A) from its packaging.
- Remove cap (1) from top of the tree pole.

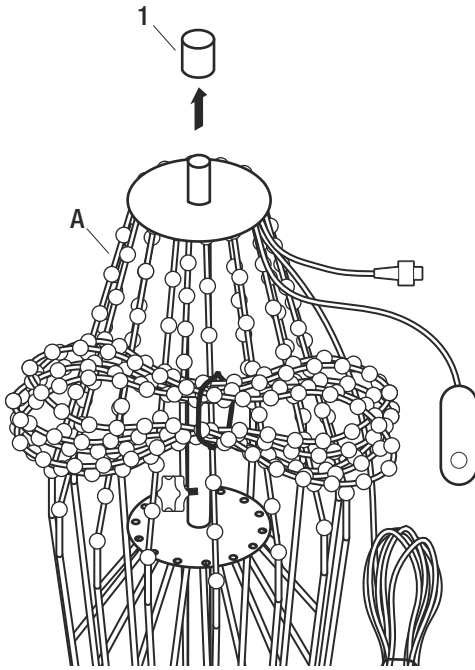

2 Connecting the Tree and Star Lights

- Connect the upper tree light connector (2) and the star topper connector (C) together.

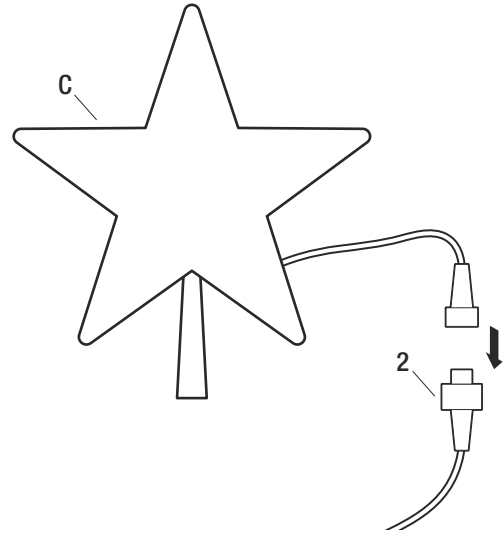

3 Attaching the Star Topper

- Place star (C) on top of the tree (A) pole.

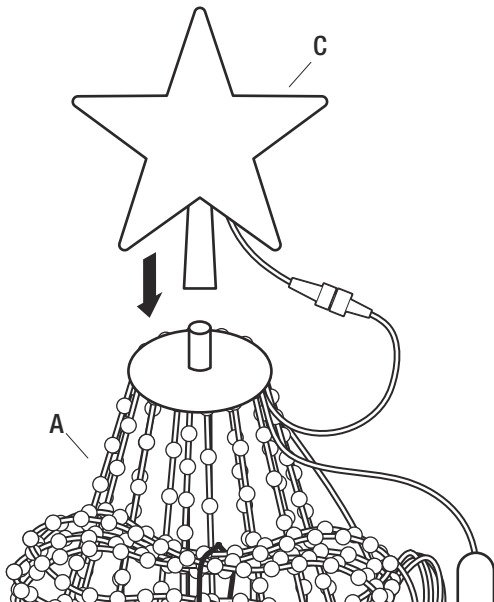

4 Attaching the Power Adapter

- Connect the bottom tree light connector (3) to the power adapter (D).

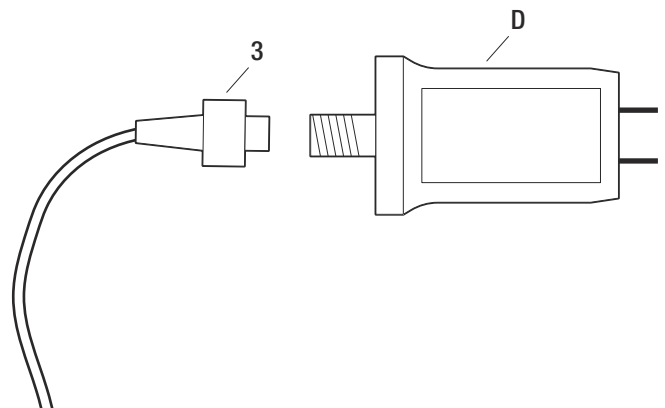

Assembly (continued)

5 Setting up the Tree

- Untie the light bundle.
- Pull the telescopic pole (A) upward until pole clicks three times and is fully extended.

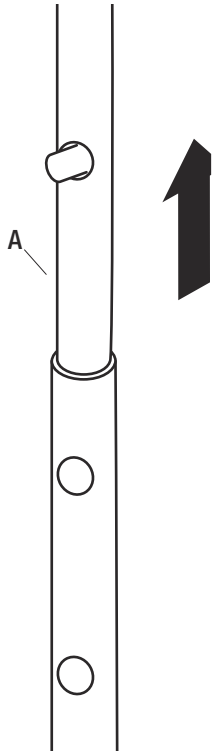

6 Securing the Tree Base

- Press tree base plate down until it is flat.
- Tighten screw (5) at bottom of base to secure.
- Use ground stakes (E) to secure as needed.

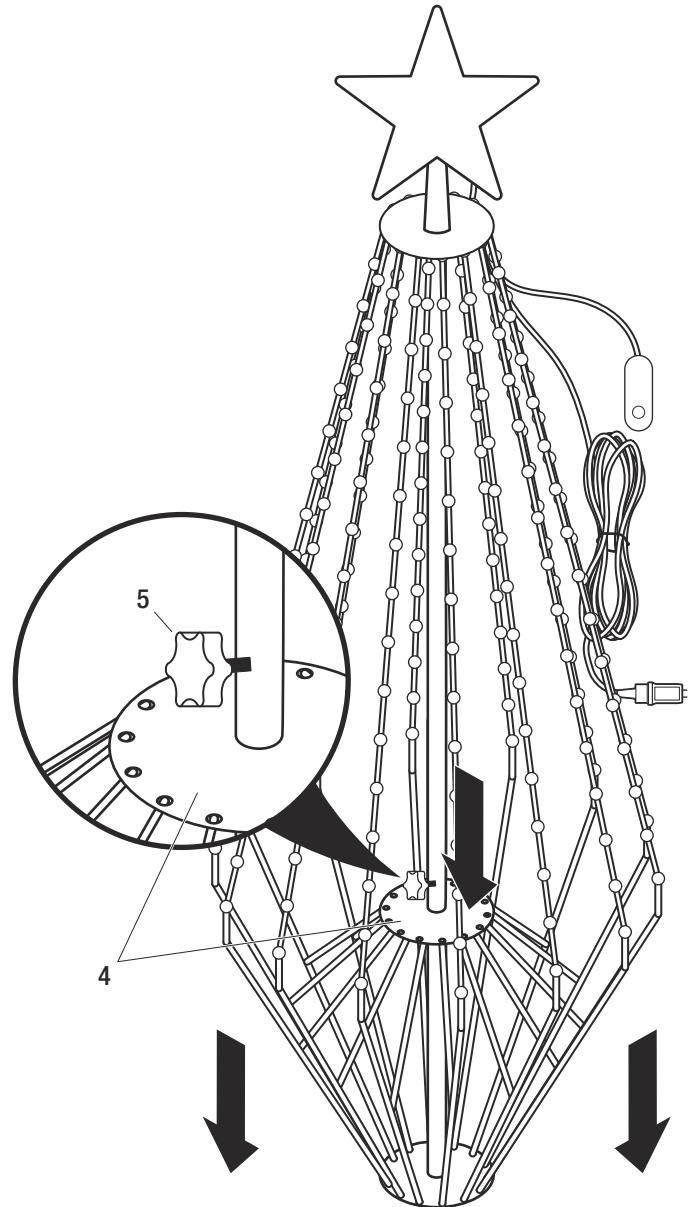

7 Lighting the Tree

- Plug in the power adapter (D) to light the tree.
- Use the controller box (B) or the remote control (F) to choose desired light setting.

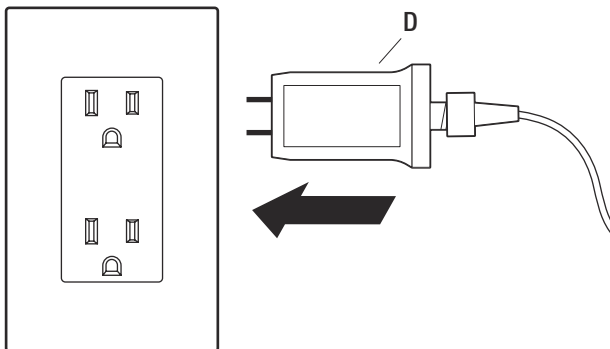

Remote Control Operations

ON-OFF/TIMER/SPEED SETTINGS

- ON: Turn on.
- OFF: Turn off.
- MODE: Click to change functions/modes one by one.
- 4H: Timer 4 hours on and 20 hours off.
- 6H: Timer 6 hours on and 18 hours off.
- 8H: Timer 8 hours on and 16 hours off.
- TIMER OFF: Turn timer off.
- SPEED +: Speed up motion function.
- SPEED -: Slow down motion function.

31 LIGHT FUNCTIONS

- 16 SOLID COLOR FUNCTIONS: 16 color buttons for solid/steady color modes.
- STROBE: Colorful flash in 3 modes.
- IN WAVES: Red, white and blue rotation in 3 modes.
- JUMP: Color changing in 2 modes.
- FADE: Rainbow waterfall in 2 modes.
- FLASH: 4 colors burst/flashing in 2 modes.
- CHASE-FLASH: white and amber lights fall and accumulate in 2 modes.
- AUTO: ALL 14 motion functions/modes in automatic rotation loop.

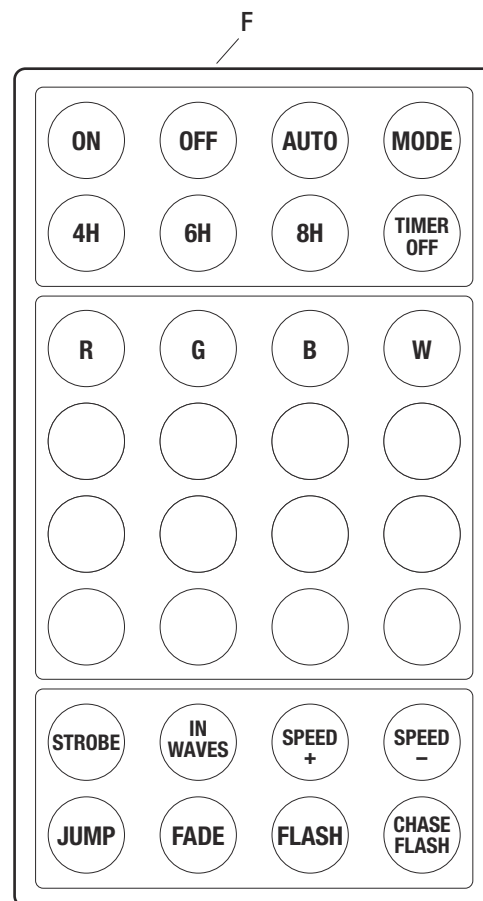

Controller Box Operations

- AUTO: All 14 functions show automatically in circulation.
- 16 single color: Press the button to change color one by one.
- 14 functions: Press the button to change function one by one.
- OFF.

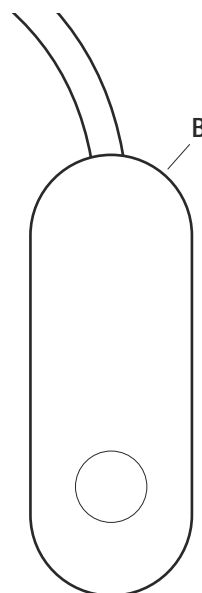

Care and Cleaning

When not in use, disassemble and store in a cool, dry location protected from sunlight.

Troubleshooting

Problem	Solution
The tree does not light when plugged in.	Check to ensure all light string connections are secure.

Warranty

The manufacturer warrants this product against defects in materials or workmanship for a period of three (3) years from the date of purchase. The manufacturer will replace defective parts on the product at no charge. This limited warranty does not cover damage resulting from accident, misuse, abuse, negligence, or normal wear and does not apply to floor models or display trees.

To obtain warranty service, you must notify The Home Depot by calling the customer service number below. **NO WARRANTY CLAIMS WILL BE CONSIDERED WITHOUT ORIGINAL PROOF OF PURCHASE.** Replacement as provided by this warranty is the exclusive remedy of the consumer and does not place the manufacturer liable for any incidental or consequential damages.

Contact the Customer Service Team at 1-855-HD-HOLIDAY or visit www.HOMEDEPOT.com.



Questions, problems, missing parts? Before returning to the store,
call Home Accents Customer Service
8 a.m. - 7 p.m., EST, Monday-Friday, 9 a.m. - 6 p.m., EST, Saturday

1-855-HD-HOLIDAY

HOMEDEPOT.COM

Retain this manual for future use.