



# Maintenance and Service Guide

HP OmniBook X Flip 14 inch 2-in-1 Laptop  
Next Gen AI PC

Model numbers: 14-fk0xxx

## SUMMARY

This guide provides maintenance information about such topics as spare parts, removal and replacement of parts, security, and backing up.



## Legal information

© Copyright 2025 HP Development Company, L.P.

AMD, FreeSync, Radeon, and Ryzen are trademarks of Advanced Micro Devices, Inc. Bluetooth is a trademark owned by its proprietor and used by HP Inc. under license. Microsoft and Windows are either registered trademarks or trademarks of Microsoft Corporation in the United States and/or other countries. USB Type-C, USB-C, the USB 10 Gbps port logo, and the USB 40 Gbps port logo are trademarks or registered trademarks of USB Implementers Forum. DisplayPort and the DisplayPort logo are trademarks owned by the Video Electronics Standards Association (VESA) in the United States and other countries. Miracast and Wi-Fi are registered trademarks of Wi-Fi Alliance.

The information contained herein is subject to change without notice. The only warranties for HP products and services are set forth in the express warranty statements accompanying such products and services. Nothing herein should be construed as constituting an additional warranty. HP shall not be liable for technical or editorial errors or omissions contained herein.

First Edition: March 2025

Document Part Number: P24408-001

### Product notice

This guide describes features that are common to most products. Some features might not be available on your computer.

Not all features are available in all editions or versions of Windows. Systems might require upgraded and/or separately purchased hardware, drivers, software, or BIOS update to take full advantage of Windows functionality. Windows is automatically updated, which is always enabled. High-speed internet and Microsoft account required. ISP fees might apply and additional requirements might apply over time for updates. See <http://www.windows.com>. **If your product ships with Windows in S Mode:** Windows in S Mode works exclusively with apps from the Microsoft Store within Windows. Certain default settings, features, and apps cannot be changed. Some accessories and apps that are compatible with Windows might not work (including some antivirus, PDF writers, driver utilities, and accessibility apps), and performance might vary, even if you switch out of S Mode. If you switch to Windows, you cannot switch back to S Mode. Learn more at [Windows.com/SmodeFAQ](https://www.windows.com/SmodeFAQ).

To access the latest user guides, go to <http://www.hp.com/support>, and follow the instructions to find your product. Then select **Setup & User Guides**.

To help us improve this document, please send any suggestions, comments, or errors to <mailto:hp.doc.feedback@hp.com>. Include the document part number when submitting your feedback.

### Software Terms

By installing, copying, downloading, or otherwise using any software product preinstalled on this computer, you agree to be bound by the terms of the HP End User License Agreement (EULA). If you do not accept these license terms, your sole remedy is to return the entire unused product (hardware and software) within 14 days for a full refund subject to the refund policy of your seller.

For any further information or to request a full refund of the price of the computer, please contact your seller.

## Safety warning notice

Reduce the possibility of heat-related injuries or of overheating the computer by following the practices described.

---

 **WARNING!** To reduce the possibility of heat-related injuries or of overheating the computer, do not place the computer directly on your lap or obstruct the computer air vents. Use the computer only on a hard, flat surface. Do not allow another hard surface, such as an adjoining optional printer, or a soft surface, such as pillows or rugs or clothing, to block airflow. Also, do not allow the AC adapter to come into contact with the skin or a soft surface, such as pillows or rugs or clothing, during operation. The computer and the AC adapter provided by HP comply with the user-accessible surface temperature limits defined by applicable safety standards.

---

## Important notice about Customer Self-Repair parts

Your computer includes Customer Self-Repair parts and parts that should be accessed only by an authorized service provider.

 **IMPORTANT:** See [Removal and replacement procedures for Customer Self-Repair parts on page 30](#) for details.

Accessing parts described in [Removal and replacement procedures for authorized service provider parts on page 40](#) can damage the computer or void your warranty.

---

# Table of contents

<b>1 Product description</b>	<b>1</b>
<b>2 Getting to know your computer</b>	<b>5</b>
Right side	5
Left side	6
Display	7
Low blue light mode (select products only)	7
Wake-on-voice (select products only)	7
Keyboard area	9
Touchpad settings and components	9
Touchpad settings	9
Adjusting touchpad settings	9
Turning on the touchpad	9
Touchpad components	9
Lights	10
Special keys	11
Rear	13
Bottom	13
360 modes	14
Labels	14
<b>3 Illustrated parts catalog</b>	<b>16</b>
Computer major components	16
Display assembly subcomponents	18
Miscellaneous parts	19
<b>4 Removal and replacement procedures preliminary requirements</b>	<b>21</b>
Tools required	21
Service considerations	21
Plastic parts	21
Cables and connectors	21
Drive handling	21
Electrostatic discharge information	22
Generating static electricity	22
Preventing electrostatic damage to equipment	23
Personal grounding methods and equipment	23
Grounding the work area	24
Recommended materials and equipment	24
Cleaning your computer	25
Enabling HP Easy Clean (select products only)	25

Removing dirt and debris from your computer.....	25
Cleaning your computer with a disinfectant.....	26
Caring for wood veneer (select products only).....	27
Packaging and transporting guidelines.....	27
Accessing support information.....	27
<b>5 Removal and replacement procedures for Customer Self-Repair parts .....</b>	<b>30</b>
Component replacement procedures .....	30
Preparation for disassembly.....	30
Bottom cover .....	30
Battery.....	33
Removing and reinstalling the same battery .....	33
Installing a new battery.....	35
<b>6 Removal and replacement procedures for authorized service provider parts.....</b>	<b>40</b>
Component replacement procedures .....	40
Solid-state drive.....	40
Speakers.....	42
WLAN module.....	43
Touchpad.....	45
I/O board.....	46
Fan.....	47
Heat sink .....	50
System board.....	51
Infrared (IR) sensor board.....	56
Display assembly.....	57
Top cover with keyboard.....	73
<b>7 Using Setup Utility (BIOS) .....</b>	<b>76</b>
Starting Setup Utility (BIOS).....	76
Updating Setup Utility (BIOS).....	76
Determining the BIOS version.....	76
Preparing for a BIOS update .....	77
Downloading a BIOS update .....	77
Installing a BIOS update .....	78
<b>8 Backing up, restoring, and recovering .....</b>	<b>79</b>
Backing up information and creating recovery media.....	79
Using Windows tools for backing up.....	79
Using the HP Cloud Recovery Download Tool to create a recovery USB flash drive (select products only).....	79
Restoring and recovering your system.....	79
Creating a system restore .....	80
Restoring and recovery methods .....	80
Recovering using the HP Recovery USB flash drive .....	80
Changing the computer boot order .....	81
Using HP Sure Recover (select products only).....	81
<b>9 Using HP PC Hardware Diagnostics .....</b>	<b>82</b>

Using HP PC Hardware Diagnostics Windows (select products only).....	82
Using an HP PC Hardware Diagnostics Windows hardware failure ID code.....	82
Accessing HP PC Hardware Diagnostics Windows.....	82
Accessing HP PC Hardware Diagnostics Windows from HP Support Assistant.....	82
Accessing HP PC Hardware Diagnostics Windows from the Start menu (select products only).....	83
Downloading HP PC Hardware Diagnostics Windows.....	83
Downloading the latest HP PC Hardware Diagnostics Windows version from HP.....	83
Downloading the HP PC Hardware Diagnostics Windows from the Microsoft Store.....	83
Downloading HP Hardware Diagnostics Windows by product name or number (select products only).....	84
Installing HP PC Hardware Diagnostics Windows.....	84
Using HP PC Hardware Diagnostics UEFI.....	84
Using an HP PC Hardware Diagnostics UEFI hardware failure ID code.....	84
Starting HP PC Hardware Diagnostics UEFI.....	84
Starting HP PC Hardware Diagnostics UEFI through HP Hotkey Support software (select products only).....	85
Downloading HP PC Hardware Diagnostics UEFI to a USB flash drive.....	85
Downloading the latest HP PC Hardware Diagnostics UEFI version.....	86
Downloading HP PC Hardware Diagnostics UEFI by product name or number (select products only).....	86
Using Remote HP PC Hardware Diagnostics UEFI settings (select products only).....	86
Downloading Remote HP PC Hardware Diagnostics UEFI.....	86
Downloading the latest Remote HP PC Hardware Diagnostics UEFI version.....	86
Downloading Remote HP PC Hardware Diagnostics UEFI by product name or number.....	87
Customizing Remote HP PC Hardware Diagnostics UEFI settings.....	87
<b>10 Specifications.....</b>	<b>88</b>
Computer specifications.....	88
Display specifications.....	89
Solid-state drive specifications.....	89
<b>11 Power cord set requirements.....</b>	<b>91</b>
Requirements for all countries.....	91
Requirements for specific countries and regions.....	91
<b>12 Swelling or deformation of notebook battery.....</b>	<b>94</b>
Swollen notebook batteries.....	94
Swollen battery is not a safety issue.....	94
Discontinue using a swollen battery.....	94
Replace a swollen battery.....	94
Minimize battery swelling.....	94
HP Adaptive Battery Optimizer (consumer notebooks).....	95
HP Battery Health Manager (commercial notebooks).....	95
<b>13 Recycling.....</b>	<b>96</b>
<b>Index.....</b>	<b>97</b>

# 1 Product description

This table provides detailed product information.

 **NOTE:** For the latest specifications related to your computer, go to <http://www.hp.com/support> and follow the instructions to find your product. Select **Specifications & Accessories**, select **Product information**, and then select the specifications link.

**Table 1-1** Product components and their descriptions

Category	Description
<b>Product Name</b>	<b>HP OmniBook X Flip 14 Inch 2-In-1 Laptop Next Gen AI PC</b> Model numbers: 14-fk0xxx CTO model number: 14z-fk000
<b>Processors</b>	AMD® Ryzen™ AI 7 HS 350 AMD Ryzen AI 7 350 AMD Ryzen AI 5 HS 340 AMD Ryzen AI 5 340
<b>Graphics</b>	<b>Graphics</b> AMD Radeon™ 860M (R7 350) AMD Radeon 840M (R5 340) Supports: <ul style="list-style-type: none"><li>• HD decode, DX12, and HDMI</li><li>• FreeSync™ Premium Pro (Internal and External) (2.8K panel)</li><li>• FreeSync (Internal and External) (WUXGA panel)</li></ul>
<b>Display</b>	14.0 in (35.6 cm), 2.8K (2880 × 1800), OLED, bent, 100% DCI-P3, BrightView, narrow bezel, low blue light, ultrawide viewing angle (UWVA), embedded DisplayPort™ (eDP) 1.4 + panel self-refresh (PSR), 400 nits, 120 Hz (VRR), touch screen 14.0 in (35.6 cm), WUXGA (1920 × 1200), BrightView, narrow bezel, LED, UWVA, 62.5% sRGB, eDP 1.2 without PSR, touch screen, 400 nits <ul style="list-style-type: none"><li>• 16:10 Aspect Ratio</li><li>• Gorilla Glass 3</li><li>• Anti-Smudge</li><li>• Panel Certification (TUV + EyeSafe)</li><li>• EyeSafe Label</li><li>• Flicker free</li><li>• MSFT HDR Streaming Capable</li><li>• MSFT DRR (Dynamic Refresh Rate)</li></ul>

**Table 1-1 Product components and their descriptions (continued)**

<b>Category</b>	<b>Description</b>
	<ul style="list-style-type: none"> <li>• Supports Active Stylus with Windows Ink Logo</li> </ul>
	<ul style="list-style-type: none"> <li>• Supports Simultaneous Pen &amp; Touch</li> </ul>
	<ul style="list-style-type: none"> <li>• Supports WoT</li> </ul>
	<ul style="list-style-type: none"> <li>• Screen-to-body ratio: 89.58%</li> </ul>
<b>Memory</b>	On-board system memory, not accessible or upgradeable
	LPDDR5x-7500
	Supports the following configurations:
	<ul style="list-style-type: none"> <li>• 32 GB</li> <li>• 24 GB (Ryzen AI 7 processors only)</li> <li>• 16 GB</li> </ul>
<b>Primary storage</b>	<b>PCIe, Non-Volatile Memory express (NVMe), M.2 2280 solid-state drives</b>
	1 TB
	512 GB
<b>Audio and video</b>	Dual speakers
	Supports speaker swap
	Poly Studio
	DTS:X Ultra
	HP Audio Boost 2.0
<b>Video</b>	<b>HP 5 MP Camera:</b> AI integrated, USB2, indicator LED, 1 × infrared (IR) LED, f2.0, 5 MP BSI sensor, WDR/TNR/HDR, 88° wide field-of-view (WFOV)
	Dual-array digital microphone with appropriate software: beam forming, echo cancellation, noise suppression
	5 MP by 30 frames per second
	Supports Windows Hello
	Supports Human Presence Device (HPD) (disabled in book, tent, and tablet modes)
<b>Wireless</b>	<b>Integrated wireless module</b>
	MediaTek MT7925 Wi-Fi® 7 Bluetooth® 5.4 M.2 2230
	MediaTek RZ616 Wi-Fi 6E Bluetooth 5.3 M.2 2230
	<ul style="list-style-type: none"> <li>• Compatible with Miracast® devices</li> <li>• Supports Modern Standby (Connected)</li> <li>• Bluetooth Audio Offload</li> <li>• Bluetooth LE Audio</li> <li>• Wi-Fi BIOS SAR</li> <li>• Dynamic antenna gain (Wi-Fi)</li> <li>• Dynamic antenna gain (BT)</li> </ul>

**Table 1-1 Product components and their descriptions (continued)**

<b>Category</b>	<b>Description</b>
	<ul style="list-style-type: none"> <li>• UNII-4.5 GHz channel</li> </ul>
	<ul style="list-style-type: none"> <li>• WLAN Time Average SAR (TAS)</li> </ul>
<b>Ports</b>	Audio-out (headphone)/audio-in (microphone) combo jack
	HDMI 2.1 (supports up to 4K @ 60 Hz)
	USB 3.2 Gen 2 Type-A (left and right sides)
	USB 3.2 Gen 2 Type-C® (left side):
	<ul style="list-style-type: none"> <li>• Data transfer</li> <li>• Power delivery</li> <li>• HP Sleep &amp; Charge</li> <li>• DisplayPort® 1.4 out up to 4 K @ 60 Hz</li> <li>• HDMI 2.1 out up to 4 K @ 60 Hz</li> </ul>
	USB 4 Gen 4 Type-C (left side):
	<ul style="list-style-type: none"> <li>• Data transfer</li> <li>• Power delivery</li> <li>• HP Sleep &amp; Charge</li> <li>• DisplayPort 2.1 out up to 8 K at 60 Hz</li> <li>• HDMI 2.1 out up to 4 K @ 60 Hz</li> </ul>
<b>Keyboard/pointing devices</b>	<b>Keyboard</b>
	Backlit
	Integrated power button
	<b>Clickpad with image sensor</b>
	Multitouch gestures enabled
	Precision touchpad support
	Taps enabled as default
	Modern trackpad gestures
<b>Power requirements</b>	<b>Battery</b> (polymer, HP Long Life)
	3 cell, 59 Whr
	HP Fast Charge Technology
	<b>Smart AC adapters</b> (USB-C®, slim, straight)
	65 W
	<b>Power cord</b> (select products only)
	C5, premium, 1 m (3.3 ft), sticker
<b>Security</b>	Supports Trusted Platform Module (TPM) 2.0, discrete

**Table 1-1 Product components and their descriptions (continued)**

<b>Category</b>	<b>Description</b>
	Microphone mute
	Camera privacy cover
<b>Sensors</b>	Accelerometer
	Accelerometer + Gyroscope
	IR thermal sensor
	Sensor hub
<b>Operating system</b>	Windows® 11 Home 64 NextGen Premium
	Windows 11 Home 64 NextGen Standard
	Windows 11 Pro 64 NextGen Premium
	Windows 11 Pro 64 NextGen Standard
	Windows 11 Home 64 NextGen Premium Single Language Africa Market PPP
	Windows 11 Home 64 NextGen Standard Single Language Africa Market PPP
	Windows 11 Home 64 NextGen Premium Single Language APAC EM PPP
	Windows 11 Home 64 NextGen Standard Single Language APAC EM PPP
	Windows 11 Home 64 NextGen Premium Chinese Market CPPP
	Windows 11 Home 64 NextGen Standard Chinese Market CPPP
	Windows 11 Home 64 NextGen Premium Single Language India Market PPP
	Windows 11 Home 64 NextGen Standard Single Language India Market PPP
	Windows 11 Home 64 NextGen Premium Single Language Indonesia Market PPP
	Windows 11 Home 64 NextGen Standard Single Language Indonesia Market PPP
<b>Serviceability</b>	<b>End user replaceable parts</b>
	AC adapter
	Battery
	Bottom cover

## 2 Getting to know your computer



Your computer features top-rated components. This chapter provides details about your components, where they are located, and how they work.

### Right side

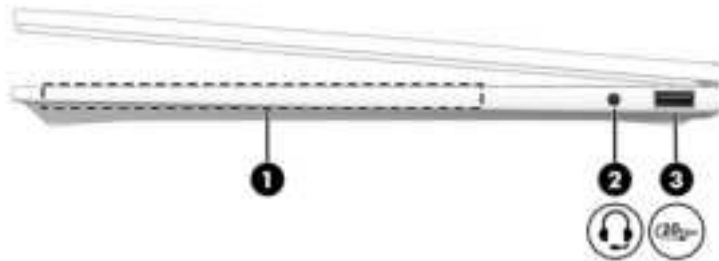
Identify the components on the right side of the computer.

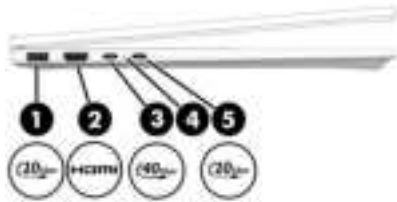

**Table 2-1** Right-side components and their descriptions



	Component	Description
(1)	Magnetic pen attachment area	Holds an optional pen.  <b>NOTE:</b> For more information about the pen, see the documentation provided with the pen.
(2)	 Audio-out (headphone)/Audio-in (microphone) combo jack	Connects optional powered stereo speakers, headphones, earbuds, a headset, or a television audio cable. Also connects an optional headset microphone. This jack does not support optional standalone microphones.  <b>WARNING!</b> To reduce the risk of personal injury, adjust the volume before putting on headphones, earbuds, or a headset. For additional safety information, see the <i>Regulatory, Safety, and Environmental Notices</i> .  To access this guide: <ul style="list-style-type: none"><li>■ Select the <b>Search</b> icon in the taskbar, type <b>HP Documentation</b> in the search box, and then select <b>HP Documentation</b>.</li></ul> <b>NOTE:</b> When a device is connected to the jack, the computer speakers are disabled.
(3)	 USB 10 Gbps port	Connects a USB device, provides high-speed data transfer, and (for select products) charges small devices (such as a smartphone) when the computer is on or in Sleep mode.  <b>NOTE:</b> Use a standard USB Type-A charging cable or cable adapter (purchased separately) when charging a small external device.

## Left side

Identify the components on the left side of the computer.



**Table 2-2** Left-side components and their descriptions

	Component	Description
(1)	 USB 10 Gbps port	Connects a USB device, provides high-speed data transfer, and (for select products) charges small devices (such as a smartphone) when the computer is on or in Sleep mode.  <b>NOTE:</b> Use a standard USB Type-A charging cable or cable adapter (purchased separately) when charging a small external device.
(2)	 HDMI port	Connects an optional video or audio device, such as a high-definition television, any compatible digital or audio component, or a high-speed High-Definition Multimedia Interface (HDMI) device.
(3)	 USB Type-C power connector and 40 Gbps port with HP Sleep and Charge and DisplayPort output	Connects an AC adapter that has a USB Type-C connector, supplying power to the computer and, if needed, charging the computer battery.  - and -  Connects a USB device, provides high-speed data transfer, and charges small devices (such as a smartphone), even when the computer is off.  <b>NOTE:</b> Use a standard USB Type-C charging cable or cable adapter (purchased separately) when charging a small external device.  - and -  Connects a display device that has a USB Type-C connector, providing DisplayPort output.
(4)	AC adapter and battery light	<ul style="list-style-type: none"> <li>• White: The AC adapter is connected and the battery is fully charged.</li> <li>• Blinking amber: The AC adapter is disconnected and the battery has reached a low battery level.</li> <li>• Amber: The AC adapter is connected and the battery is charging.</li> <li>• Off: The battery is not charging.</li> </ul>

**Table 2-2 Left-side components and their descriptions (continued)**

	Component	Description
(5)	 USB Type-C power connector and 10 Gbps port with HP Sleep and Charge and DisplayPort output	<p>Connects an AC adapter that has a USB Type-C connector, supplying power to the computer and, if needed, charging the computer battery.</p> <p>- and -</p> <p>Connects a USB device, provides high-speed data transfer, and charges small devices (such as a smartphone), even when the computer is off.</p> <p><b>NOTE:</b> Use a standard USB Type-C charging cable or cable adapter (purchased separately) when charging a small external device.</p> <p>- and -</p> <p>Connects a display device that has a USB Type-C connector, providing DisplayPort output.</p>

## Display

The computer display can include essential components such as speakers, antennas, cameras, and microphones.

### Low blue light mode (select products only)

Your computer display is shipped from the factory in low blue light mode for improved eye comfort and safety. Also, blue light mode automatically adjusts blue light emissions when you are using the computer at night or for reading.

 **WARNING!** To reduce the risk of serious injury, read the *Safety & Comfort Guide*. It describes proper workstation setup and proper posture, health, and work habits for computer users. The *Safety & Comfort Guide* also provides important electrical and mechanical safety information. The *Safety & Comfort Guide* is available on the web at <http://www.hp.com/ergo>.

### Wake-on-voice (select products only)

Use the wake-on-voice feature to bring the computer out of the Sleep state quickly.

To access the wake-on-voice settings, follow these steps:

1. Select the **Search** icon in the taskbar, type *XiaoWei* in the search box, and then select **XiaoWei**.
2. When the tool opens, scan the QR code with your mobile device, which takes you to the settings page, where you can select your wake-on-voice features.
3. Follow the on-screen instructions.

 **NOTE:** Allow the XiaoWei app to continue running on the computer.

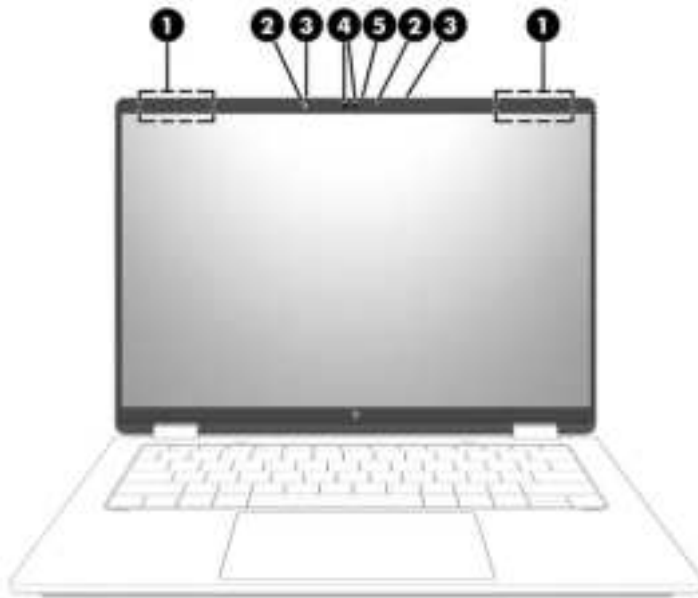

**Table 2-3** Display components and their descriptions

	Component	Description
(1)	WLAN antennas (2)*	Send and receive wireless signals to communicate with wireless local area networks (WLANs).
(2)	Camera lights (2)	On: One or more cameras are in use.
(3)	Internal microphones (2)	Record sound.
(4)	Cameras (2)	Allow you to video chat, record video, and record still images. Some cameras also allow a facial recognition logon to Windows®, instead of a password logon.  <b>NOTE:</b> Camera functions vary depending on the camera hardware and software installed on your product.
(5)	Camera privacy cover	By default, the camera lens is uncovered, but you can slide the camera privacy cover to block the camera's view. To use the camera, slide the camera privacy cover in the opposite direction to reveal the lens.

\*The antennas are not visible from the outside of the computer. For optimal transmission, keep the areas immediately around the antennas free from obstructions.

For wireless regulatory notices, see the section of the *Regulatory, Safety, and Environmental Notices* that applies to your country or region.

To access this guide:

- Select the **Search** icon in the taskbar, type `HP Documentation` in the search box, and then select **HP Documentation**.

# Keyboard area

Keyboards can vary by language.

---

 **NOTE:** The keyboard area, including the function keys and (select products only) power key, is disabled in stand, tent, and tablet modes. To enable the keyboard, including the power key, change to the clamshell mode.

---

## Touchpad settings and components

Learn the touchpad settings and components.

### Touchpad settings

Learn how to adjust touchpad settings.

#### Adjusting touchpad settings

Use these steps to adjust touchpad settings and gestures.

1. Select the **Search** icon in the taskbar, type `touchpad settings` in the search box, and then press `enter`.
2. Choose a setting.

#### Turning on the touchpad

Follow these steps to turn on the touchpad.

1. Select the **Search** icon in the taskbar, type `touchpad settings` in the search box, and then press `enter`.
2. Using an external mouse, click the **touchpad** button.

If you are not using an external mouse, press the **Tab** key repeatedly until the pointer rests on the **touchpad** button. Then press the `spacebar` to select the button.

### Touchpad components

Identify the touchpad components.

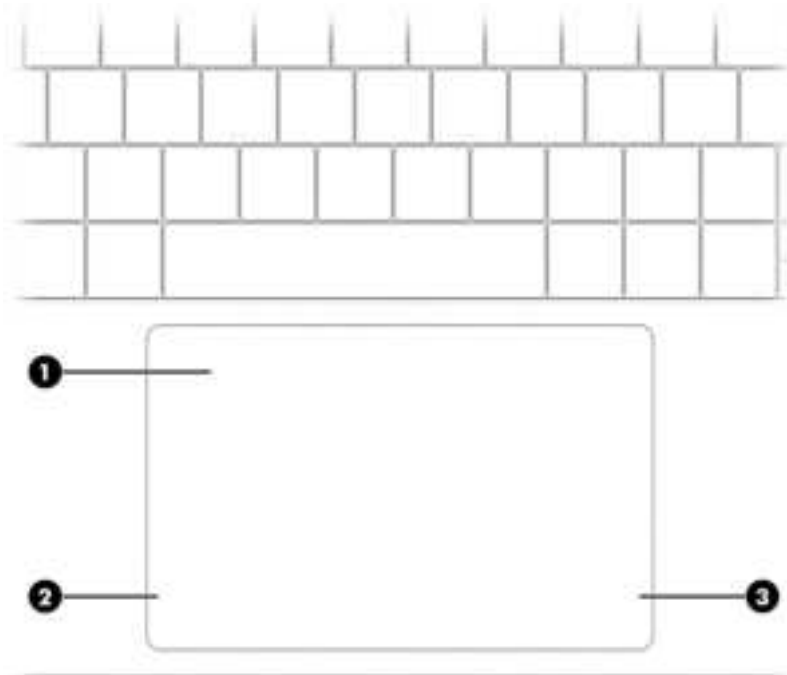
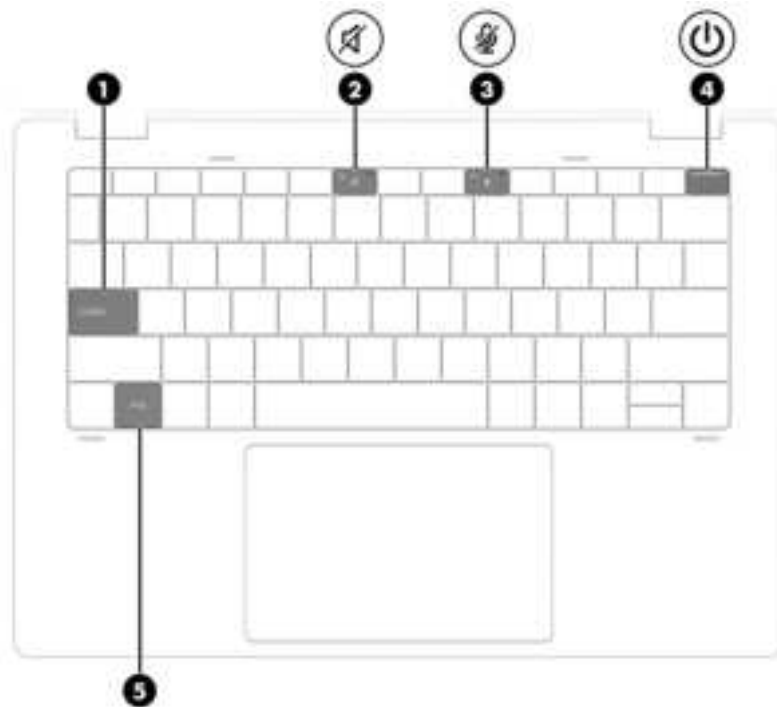

**Table 2-4** Touchpad components and their descriptions



Component	Description
(1) Touchpad zone	Reads your finger gestures to move the pointer or activate items on the screen.
(2) Left touchpad button	Functions like the left button on an external mouse.
(3) Right touchpad button	Functions like the right button on an external mouse.

## Lights

Identify the lights on the computer.

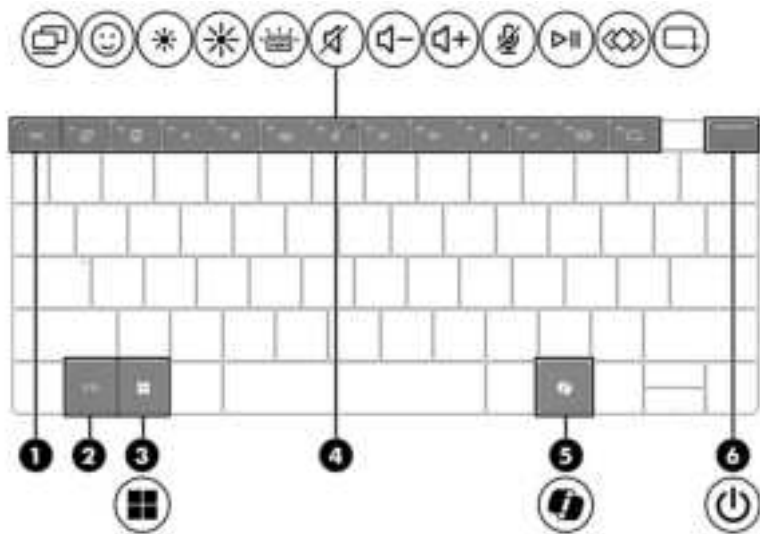

**Table 2-5** Lights and their descriptions



	Component	Description
(1)	Caps lock light	On: Caps lock is on, which switches the key input to all capital letters.
(2)	 Mute light	<ul style="list-style-type: none"> <li>On: Computer sound is off.</li> <li>Off: Computer sound is on.</li> </ul>
(3)	 Microphone mute light	<ul style="list-style-type: none"> <li>On: Microphone is off.</li> <li>Off: Microphone is on.</li> </ul>
(4)	 Power light	<ul style="list-style-type: none"> <li>On: The computer is on.</li> <li>Blinking (select products only): The computer is in the Sleep state, a power-saving state. The computer shuts off power to the display and other unnecessary components.</li> <li>Off: Depending on your computer model, the computer is off, in Hibernation, or in Sleep. Hibernation is the power-saving state that uses the least amount of power.</li> </ul>
(5)	Fn lock light	On: The <b>fn</b> key is locked.

## Special keys



Identify the special keys.



**Table 2-6** Special keys and their descriptions

	Component	Description
(1)	esc key	Displays system information when pressed in combination with the <b>fn</b> key.
(2)	fn key	Executes specific functions when pressed in combination with another key.
(3)	 Windows key	Opens the Start menu.  <b>NOTE:</b> Pressing the Windows key again will close the Start menu.
(4)	Action keys	Execute frequently used system functions as defined by the icon symbols on <b>f1</b> through <b>f12</b> function keys.
(5)	 Windows Copilot key	Opens Windows Copilot (select products only).  <b>NOTE:</b> Copilot in Windows (select products only) requires Windows 11. Some features require a neural processing unit (NPU). The timing of feature delivery and availability varies by market and device. You must have a Microsoft account to use the Copilot feature. When the Copilot feature is not available, pressing the Copilot key opens the Bing search engine. See <a href="http://aka.ms/WindowsAIFeatures">http://aka.ms/WindowsAIFeatures</a> .
(6)		

**Table 2-6** Special keys and their descriptions (continued)

	Component	Description
(6)	 Power key	<ul style="list-style-type: none"><li>• When the computer is off, press the key briefly to turn on the computer.</li><li>• When the computer is on, press the key briefly to initiate Sleep.</li><li>• When the computer is in the Sleep state, press the key briefly to exit Sleep (select products only).</li><li>• When the computer is in Hibernation, press the key briefly to exit Hibernation.</li></ul> <p><b>IMPORTANT:</b> Pressing and holding down the power key results in the loss of unsaved information.</p> <p>If the computer has stopped responding and shutdown procedures are ineffective, press and hold the power key down for at least 10 seconds to turn off the computer.</p> <p>To learn more about your power and sleep settings:</p> <ul style="list-style-type: none"><li>▪ Right-click the <b>Power</b> icon , and then select <b>Power and sleep settings</b>.</li></ul>

## Rear

Identify the rear component.

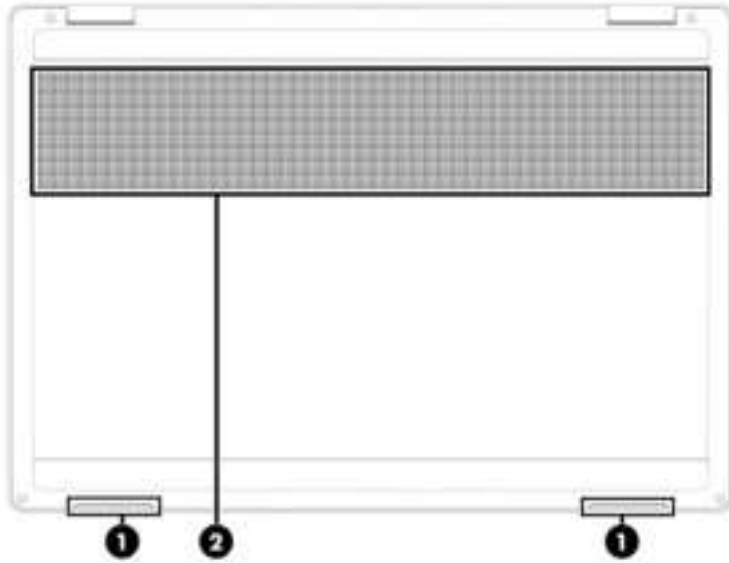

**Table 2-7** Rear component and its description

Component	Description
Vent	<p>Enables airflow to cool internal components.</p> <p><b>NOTE:</b> The computer fan starts up automatically to cool internal components and prevent overheating. It is normal for the internal fan to cycle on and off during routine operation.</p>

## Bottom

Identify the bottom components.



**Table 2-8** Bottom components and their descriptions

	Component	Description
(1)	Speakers (2)	Produce sound.
(2)	Vent	Enables airflow to cool internal components.

**NOTE:** The computer fan starts up automatically to cool internal components and prevent overheating. It is normal for the internal fan to cycle on and off during routine operation.

## 360 modes

If your computer offers 360 modes, the following illustration shows how you can use and fold your device.



## Labels

The labels affixed to the computer provide information that you might need when you troubleshoot system problems or travel internationally with the computer. Labels can be in paper form or imprinted on the product.

- IMPORTANT:** Check the following locations for the labels described in this section: the bottom of the computer, inside the battery bay, under the service door, on the back of the display, or on the bottom of a tablet kickstand.

- Service label—Provides important information to identify your computer. When contacting support, you might be asked for the serial number, the product number, or the model number. Locate this information before you contact support.

Your service label will resemble the following example.

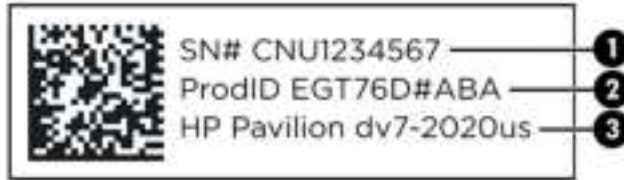

**Table 2-9** Service label components

Component	
(1)	Serial number
(2)	Product ID
(3)	HP product name and model number

- Regulatory labels—Provide regulatory information about the computer.
- Wireless certification labels—Provide information about optional wireless devices and the approval markings for the countries or regions in which the devices have been approved for use.

---

## 3 Illustrated parts catalog

Use this chapter to determine the spare parts that are available for the computer.

### Computer major components

To identify the computer major components, use this illustration and table.

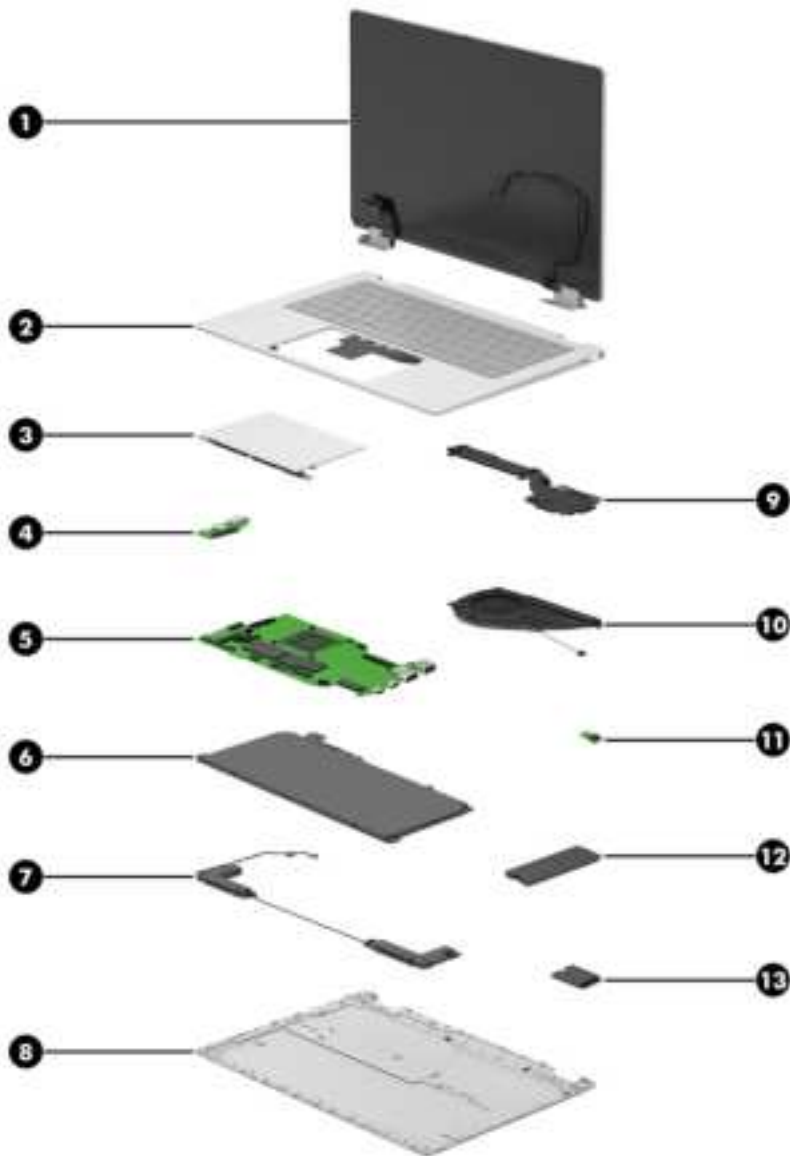

**Table 3-1 Computer major component descriptions and part numbers**

Item	Component	Spare part number
(1)	<b>Display assembly</b>  <b>NOTE:</b> Display assemblies are offered as spare parts only at a subcomponent level. For more information, see <a href="#">Display assembly subcomponents on page 18</a> .	not available as a spare part
(2)	<b>Top cover with keyboard</b>  <b>NOTE:</b> For a detailed list of country codes, see <a href="#">Top cover with keyboard on page 73</a> .	
	Glacier silver	P31158-xx1
	Meteor silver	P31159-xx1
(3)	<b>Touchpad</b>  <b>NOTE:</b> The touchpad cable is available using spare part number P31092-001.	
	Glacier silver	P31107-001
	Meteor silver	P31108-001
(4)	<b>I/O board</b> (includes cable)	P31160-001
(5)	<b>System board</b> (includes processor; for use in models with the Windows operating system)	
	AMD Ryzen AI 7 HS 350 processor and 32 GB system memory	P31155-601
	AMD Ryzen AI 7 HS 350 processor and 24 GB system memory	P31154-601
	AMD Ryzen AI 7 HS 350 processor and 16 GB system memory	P31153-601
	AMD Ryzen AI 7 350 processor and 32 GB system memory	P31151-601
	AMD Ryzen AI 7 350 processor and 24 GB system memory	P31150-601
	AMD Ryzen AI 7 350 processor and 16 GB system memory	P31149-601
	AMD Ryzen AI 5 HS 340 processor and 16 GB system memory	P31152-601
	AMD Ryzen AI 5 340 processor and 16 GB system memory	P31148-601
(6)	<b>Battery</b> (3 cell, 59 Whr) (includes revive kit)	N66215-001
(7)	<b>Speakers</b> (left and right)	P31115-001
(8)	<b>Bottom cover</b>	
	Glacier silver	P31111-001
	Meteor silver	P31112-001
(9)	<b>Heat sink</b>	P31162-001
(10)	<b>Fan</b>	P31113-001
(11)	<b>IR sensor board</b> (includes cable)	P31161-001
(12)	<b>Solid-state drive</b> (PCIe)  <b>NOTE:</b> The solid state drive thermal pad is available as spare part number P31093-001.	
	1 TB	N77394-005
	512 GB	N77392-005
(13)	<b>WLAN module</b>	

**Table 3-1** Computer major component descriptions and part numbers (continued)

Item	Component	Spare part number
	MediaTek MT7922 Wi-Fi 6E Bluetooth 5.2	N22541-005
	MediaTek MT7925 Wi-Fi 7 Bluetooth 5.4	N64647-005

## Display assembly subcomponents

To identify the display assembly subcomponents, use this illustration and table.

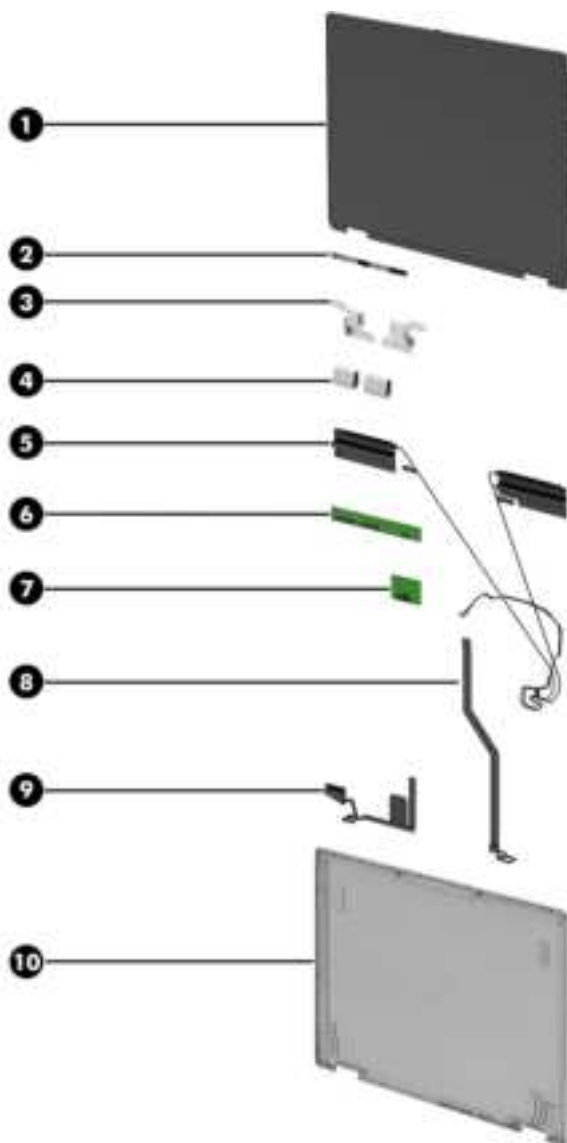

**Table 3-2** Display component descriptions and part numbers

Item	Component	Spare part number
(1)	Display panel (includes cable, panel stretchable tape, and touch board tape and stretchable tape)	

**Table 3-2 Display component descriptions and part numbers (continued)**

Item	Component	Spare part number
	2.8K, OLED	P31157-001
	WUXGA, LED	P31156-001
(2)	<b>Camera module</b> (includes cable, rubber piece, and panel stretchable tape)	P31109-001
(3)	<b>Hinges</b> (left and right, includes panel stretchable tape)	P31100-001
(4)	<b>Hinge covers</b> (left and right, includes panel stretchable tape)	
	Glacier silver	P31101-001
	Meteor silver	P32366-001
(5)	<b>Wireless antenna kit</b> (included in the Cable Kit)	P31092-001
(6)	<b>Touch control board</b> (includes display cable and panel stretchable tape)	P31105-001
(7)	<b>OLED board</b> (includes display cable, foil, thermal pad, and panel stretchable tape)	P31104-001
(8)	<b>Camera cable</b> (included in the Cable Kit)	P31092-001
(9)	<b>Display panel cable</b> (includes panel stretchable tape)	P31091-001
(10)	<b>Display back cover</b> (includes wireless antennas and panel stretchable tape)	
	Glacier silver, LED models	P31095-001
	Meteor silver, LED models	P31096-001
	Glacier silver, OLED models	P31098-001
	Meteor silver, OLED models	P31099-001

## Miscellaneous parts

To identify the miscellaneous parts, use this table.

**Table 3-3 Miscellaneous part descriptions and part numbers**

Component	Spare part number
<b>Slim AC adapter</b> (65 W, nPFC, USB-C)	M54350-001
<b>Screw Kit</b>	P31093-001
<b>Cable Kit</b> (includes I/O board cable, IR sensor board cable, camera cable, touchpad cable, battery cable, and wireless antenna cables)	P31092-001
<b>Pen, silver</b> (includes cable)	N44378-001
<b>Power cords</b> (C5, premium, 1.0 m [3.3 ft])	
Australia	L22327-001
Denmark	L22322-001
Europe (Austria, Belgium, Finland, France, Germany, the Netherlands, Norway, and Sweden)	L22321-001
India	L22624-001
Japan	L22330-001
North America	L22319-001

**Table 3-3** Miscellaneous part descriptions and part numbers (continued)

<b>Component</b>	<b>Spare part number</b>
The People's Republic of China	L21930-001
South Africa	L22325-001
South Korea	L22328-001
Switzerland	L22324-001
Taiwan	L22329-001
Thailand	L22326-001
Thailand bundle	M85421-001
United Kingdom	L22320-001

---

## 4 Removal and replacement procedures preliminary requirements

Use this information to properly prepare to disassemble and reassemble the computer.

### Tools required

You need the following tools to complete the removal and replacement procedures:

- Tweezers
- Nonconductive, nonmarking pry tool
- Magnetic Phillips P1 screwdriver

### Service considerations

The following sections include some of the considerations that you must keep in mind during disassembly and assembly procedures.

---

 **NOTE:** As you remove each subassembly from the computer, place the subassembly and all accompanying screws away from the work area to prevent damage.

---

### Plastic parts

Using excessive force during disassembly and reassembly can damage plastic parts.

### Cables and connectors

Handle cables with extreme care to avoid damage.

---

 **IMPORTANT:** When servicing the computer, be sure that cables are placed in their proper locations during the reassembly process. Improper cable placement can damage the computer.

---

Apply only the tension required to unseat or seat the cables during removal and insertion. Handle cables by the connector whenever possible. In all cases, avoid bending, twisting, or tearing cables. Be sure that cables are routed so that they cannot be caught or snagged as you remove or replace parts. Handle flex cables with extreme care; these cables tear easily.

### Drive handling

Note the following guidelines when handling drives.

---

 **IMPORTANT:** Drives are fragile components. Handle them with care. To prevent damage to the computer, damage to a drive, or loss of information, observe these precautions:

- Before removing or inserting a hard drive, shut down the computer. If you are unsure whether the computer is off or in Hibernation or Sleep mode, turn the computer on, and then shut it down through the operating system.

- Before handling a drive, be sure that you are discharged of static electricity. While handling a drive, avoid touching the connector.
  - Before removing an optical drive, be sure that a disc is not in the drive, and be sure that the optical drive tray is closed.
  - Handle drives on surfaces covered with at least 2.54 cm (1 inch) of shock-proof foam.
  - Avoid dropping drives from any height onto any surface.
  - After removing a hard drive or an optical drive, place it in a static-proof bag.
  - Avoid exposing an internal hard drive to products that have magnetic fields, such as monitors or speakers.
  - Avoid exposing a drive to temperature extremes or liquids.
  - If a drive must be mailed, place the drive in a bubble pack mailer or other suitable form of protective packaging, and label the package "FRAGILE."
- 

## Electrostatic discharge information

A sudden discharge of static electricity from your finger or other conductor can destroy static-sensitive devices or microcircuitry. Often the spark is neither felt nor heard, but damage occurs. An electronic device exposed to electrostatic discharge (ESD) might not appear to be affected at all and can work perfectly throughout a normal cycle. The device might function normally for a while, but it has been degraded in the internal layers, reducing its life expectancy.

Networks built into many integrated circuits provide some protection, but in many cases, the discharge contains enough power to alter device parameters or melt silicon junctions.

---

 **IMPORTANT:** To prevent damage to the device when you remove or install internal components, observe these precautions:

- Keep components in their electrostatic-safe containers until you are ready to install them.
  - Before touching an electronic component, discharge static electricity by using the guidelines described in [Personal grounding methods and equipment on page 23](#).
  - Avoid touching pins, leads, and circuitry. Handle electronic components as little as possible.
  - If you remove a component, place it in an electrostatic-safe container.
- 

## Generating static electricity

Follow these static electricity guidelines:

- Different activities generate different amounts of static electricity.
- Static electricity increases as humidity decreases.

**Table 4-1 Static electricity occurrence based on activity and humidity**

Event	55% relative humidity	40% relative humidity	10% relative humidity
Walking across carpet	7,500 V	15,000 V	35,000 V
Walking across vinyl floor	3,000 V	5,000 V	12,000 V
Motions of bench worker	400 V	800 V	6,000 V
Removing dual in-line packages (DIPs) from plastic tube	400 V	700 V	2,000 V
Removing DIPs from vinyl tray	2,000 V	4,000 V	11,500 V
Removing DIPs from polystyrene foam	3,500 V	5,000 V	14,500 V
Removing bubble pack from PCB (printed circuit board)	7,000 V	20,000 V	26,500 V
Packing PCBs in foam-lined box	5,000 V	11,000 V	21,000 V

 **NOTE:** Multiple electric components can be packaged together in plastic tubes, trays, or polystyrene foam.

As little as 700 V of static electricity can degrade a product.

## Preventing electrostatic damage to equipment

Many electronic components are sensitive to ESD. Circuitry design and structure determine the degree of sensitivity.

The following packaging and grounding precautions are necessary to prevent static electricity damage to electronic components:

- To avoid hand contact, transport products in static-safe containers such as tubes, bags, or boxes.
- Protect all electrostatic parts and assemblies with conductive or approved containers or packaging.
- Keep electrostatic-sensitive parts in their containers until they arrive at static-free stations.
- Place items on a grounded surface before removing them from their container.
- Always be properly grounded when touching a sensitive component or assembly.
- Avoid contact with pins, leads, or circuitry.
- Place reusable electrostatic-sensitive parts from assemblies in protective packaging or conductive foam.

## Personal grounding methods and equipment

Using certain equipment can prevent static electricity damage to electronic components.

- **Wrist straps** are flexible straps with a maximum of  $1\text{ M}\Omega \pm 10\%$  resistance in the ground cords. To provide proper ground, wear a strap snug against bare skin. Verify that the ground cord is connected and fits snugly into the banana plug connector on the grounding mat or workstation.
- You can use **heel straps, toe straps, and boot straps** at standing workstations. These straps are compatible with most types of shoes or boots. On conductive floors or dissipative floor mats, use them on both feet with a maximum of  $1\text{ M}\Omega \pm 10\%$  resistance between the operator and ground.

**Table 4-2 Static shielding protection levels**

Method	Voltage
Antistatic plastic	1,500
Carbon-loaded plastic	7,500
Metallized laminate	15,000

## Grounding the work area

To prevent static damage at the work area, follow these precautions:

- Cover the work surface with approved static-dissipative material.
- Use a wrist strap connected to a properly grounded work surface and use properly grounded tools and equipment.
- Use static-dissipative mats, foot straps, or air ionizers to give added protection.
- Handle electrostatic sensitive components, parts, and assemblies by the case or PCB laminate. Handle them only at static-free work areas.
- Turn off power and input signals before inserting and removing connectors or test equipment.
- Use fixtures made of static-safe materials when fixtures must directly contact dissipative surfaces.
- Keep the work area free of nonconductive materials, such as ordinary plastic assembly aids and polystyrene foam.
- Use conductive field service tools, such as cutters, screwdrivers, and vacuums.
- Avoid contact with pins, leads, or circuitry.

## Recommended materials and equipment

HP recommends certain materials and equipment to prevent static electricity:

- Antistatic tape
- Antistatic smocks, aprons, or sleeve protectors
- Conductive bins and other assembly or soldering aids
- Conductive foam
- Conductive tabletop workstations with ground cord of  $1\text{ M}\Omega \pm 10\%$  resistance
- Static-dissipative table or floor mats with hard tie to ground
- Field service kits
- Static awareness labels
- Wrist straps and footwear straps providing  $1\text{ M}\Omega \pm 10\%$  resistance
- Material handling packages
- Conductive plastic bags

- Conductive plastic tubes
- Conductive tote boxes
- Opaque shielding bags
- Transparent metallized shielding bags
- Transparent shielding tubes

## Cleaning your computer

Cleaning your computer regularly removes dirt and debris so that your device continues to operate at its best. Use the following information to safely clean the external surfaces of your computer.

### Enabling HP Easy Clean (select products only)

HP Easy Clean helps you to avoid accidental input while you clean the computer surfaces. This software disables devices such as the keyboard, touch screen, and touchpad for a preset amount of time so that you can clean all computer surfaces.

1. Start HP Easy Clean in one of the following ways:
  - Select the **Start** menu, and then select **HP Easy Clean**.
  - Select the **HP Easy Clean** icon in the taskbar.
  - Select **Start**, and then select the **HP Easy Clean** tile.
2. Now that your device is disabled for a short period, see [Removing dirt and debris from your computer on page 25](#) for the recommended steps to clean the high-touch, external surfaces on your computer. After you remove the dirt and debris, you can also clean the surfaces with a disinfectant. See [Cleaning your computer with a disinfectant on page 26](#) for guidelines to help prevent the spread of harmful bacteria and viruses.

### Removing dirt and debris from your computer

Here are the recommended steps to clean dirt and debris from your computer.

For computers with wood veneer, see [Caring for wood veneer \(select products only\) on page 27](#).

1. Wear disposable gloves made of latex (or nitrile gloves, if you are latex-sensitive) when cleaning the surfaces.
2. Turn off your device and unplug the power cord and other connected external devices. Remove any installed batteries from items such as wireless keyboards.

---

 **CAUTION:** To prevent electric shock or damage to components, never clean a product while it is turned on or plugged in.

---

3. Moisten a microfiber cloth with water. The cloth should be moist, but not dripping wet.

---

 **IMPORTANT:** To avoid damaging the surface, avoid abrasive cloths, towels, and paper towels.

---

4. Wipe the exterior of the product gently with the moistened cloth.

---

 **IMPORTANT:** Keep liquids away from the product. Avoid getting moisture in any openings. If liquid makes its way inside your HP product, it can cause damage to the product. Do not spray liquids directly on the product. Do not use aerosol sprays, solvents, abrasives, or cleaners containing hydrogen peroxide or bleach that might damage the finish.

---

5. Start with the display (if applicable). Wipe carefully in one direction, and move from the top of the display to the bottom. Finish with any flexible cables, like power cord, keyboard cable, and USB cables.
6. Be sure that surfaces have completely air-dried before turning the device on after cleaning.
7. Discard the gloves after each cleaning. Clean your hands immediately after you remove the gloves.

See [Cleaning your computer with a disinfectant on page 26](#) for recommended steps to clean the high-touch, external surfaces on your computer to help prevent the spread of harmful bacteria and viruses.

## Cleaning your computer with a disinfectant

The World Health Organization (WHO) recommends cleaning surfaces, followed by disinfection, as a best practice for preventing the spread of viral respiratory illnesses and harmful bacteria.

After cleaning the external surfaces of your computer using the steps in [Removing dirt and debris from your computer on page 25](#), [Caring for wood veneer \(select products only\) on page 27](#), or both, you might also choose to clean the surfaces with a disinfectant. A disinfectant that is within HP's cleaning guidelines is an alcohol solution consisting of 70% isopropyl alcohol and 30% water. This solution is also known as rubbing alcohol and is sold in most stores.

Follow these steps when disinfecting high-touch, external surfaces on your computer:

1. Wear disposable gloves made of latex (or nitrile gloves, if you are latex-sensitive) when cleaning the surfaces.
2. Turn off your device and unplug the power cord and other connected external devices. Remove any installed batteries from items such as wireless keyboards.

---

 **CAUTION:** To prevent electric shock or damage to components, never clean a product while it is turned on or plugged in.

---

3. Moisten a microfiber cloth with a mixture of 70% isopropyl alcohol and 30% water. The cloth should be moist, but not dripping wet.

---

 **CAUTION:** Do not use any of the following chemicals or any solutions that contain them, including spray-based surface cleaners: bleach, peroxides (including hydrogen peroxide), acetone, ammonia, ethyl alcohol, methylene chloride, or any petroleum-based materials, such as gasoline, paint thinner, benzene, or toluene.

---

 **IMPORTANT:** To avoid damaging the surface, avoid abrasive cloths, towels, and paper towels.

---

4. Wipe the exterior of the product gently with the moistened cloth.

---

 **IMPORTANT:** Keep liquids away from the product. Avoid getting moisture in any openings. If liquid makes its way inside your HP product, it can cause damage to the product. Do not spray liquids directly on the product. Do not use aerosol sprays, solvents, abrasives, or cleaners containing hydrogen peroxide or bleach that might damage the finish.

---

5. Start with the display (if applicable). Wipe carefully in one direction, and move from the top of the display to the bottom. Finish with any flexible cables, like power cord, keyboard cable, and USB cables.
6. Be sure that surfaces have completely air-dried before turning the device on after cleaning.
7. Discard the gloves after each cleaning. Clean your hands immediately after you remove the gloves.

## Caring for wood veneer (select products only)

Your product might feature high-quality wood veneer. As with all natural wood products, proper care is important for best results over the life of the product. Because of the nature of natural wood, you might see unique variations in the grain pattern or subtle variations in color, which are normal.

- Clean the wood with a dry, static-free microfiber cloth or chamois.
- Avoid cleaning products containing substances such as ammonia, methylene chloride, acetone, turpentine, or other petroleum-based solvents.
- Do not expose the wood to sun or moisture for long periods of time.
- If the wood becomes wet, dry it by dabbing with an absorbent, lint-free cloth.
- Avoid contact with any substance that might dye or discolor the wood.
- Avoid contact with sharp objects or rough surfaces that might scratch the wood.

See [Removing dirt and debris from your computer on page 25](#) for the recommended steps to clean the high-touch, external surfaces on your computer. After you remove the dirt and debris, you can also clean the surfaces with a disinfectant. See [Cleaning your computer with a disinfectant on page 26](#) for sanitizing guidelines to help prevent the spread of harmful bacteria and viruses.

## Packaging and transporting guidelines

Follow these grounding guidelines when packaging and transporting equipment:

- To avoid hand contact, transport products in static-safe tubes, bags, or boxes.
- Protect ESD-sensitive parts and assemblies with conductive or approved containers or packaging.
- Keep ESD-sensitive parts in their containers until the parts arrive at static-free workstations.
- Place items on a grounded surface before removing items from their containers.
- Always be properly grounded when touching a component or assembly.
- Store reusable ESD-sensitive parts from assemblies in protective packaging or nonconductive foam.
- Use transporters and conveyors made of antistatic belts and roller bushings. Be sure that mechanized equipment used for moving materials is wired to ground and that proper materials are selected to avoid static charging. When grounding is not possible, use an ionizer to dissipate electric charges.

## Accessing support information

To find the HP support that you need, use this information.

**Table 4-3 Support information locations**

Service consideration	Path to access information
<p>Records of reported failure incidents stored on the computer</p>	<p><b>Windows®:</b></p> <p>Preoperating system failures are logged in the BIOS Event Log. To view the BIOS Event Log:</p> <ol style="list-style-type: none"> <li>1. Press the power button.</li> <li>2. Immediately and repeatedly press <b>esc</b> when the power button light turns white.</li> </ol> <p><b>NOTE:</b> If you do not press <b>esc</b> at the appropriate time, you must restart the computer and again repeatedly press <b>esc</b> when the power button light turns white to access the utility.</p> <ol style="list-style-type: none"> <li>3. Press <b>f10</b> to enter the BIOS setup.</li> <li>4. Complete one of these tasks: <ul style="list-style-type: none"> <li>• (On commercial products) Under the <b>Main</b> tab, select <b>BIOS event log</b>, and then select <b>View BIOS Event Log</b>.</li> <li>• (On consumer products) Under the <b>Main</b> tab, select <b>System Log</b>.</li> </ul> </li> </ol> <p>Post-operating system failures are logged in the Event Viewer.</p> <ol style="list-style-type: none"> <li>1. Turn on the computer and allow the operating system to open.</li> <li>2. Select the search icon  in the taskbar.</li> <li>3. Type <code>Event Viewer</code>, and then press <b>enter</b>.</li> <li>4. Select the log from the left panel. Details display in the right panel.</li> </ol> <p><b>Chrome™:</b></p> <ol style="list-style-type: none"> <li>1. Go to <a href="https://support.google.com/chrome">support.google.com/chrome</a>.</li> <li>2. Search <code>collect Chrome device logs</code>.</li> </ol>
<p>Technical bulletins</p>	<p>To locate technical bulletins:</p> <ol style="list-style-type: none"> <li>1. Go to <a href="https://www.hp.com">www.hp.com</a>.</li> <li>2. Place the cursor over <b>Problem solving</b> to display more options.</li> <li>3. Select <b>Support &amp; Troubleshooting</b>.</li> <li>4. Type the serial number, product number, or product name to go to the product support page.</li> <li>5. Select <b>Advisories</b> to view technical bulletins.</li> </ol>
<p>Repair professionals</p>	<p>To locate repair professionals:</p> <ol style="list-style-type: none"> <li>1. Go to <a href="https://www.hp.com">www.hp.com</a>.</li> <li>2. Place the cursor over <b>Support resources</b> to display more options.</li> <li>3. Select <b>Authorized service providers</b>.</li> </ol>

**Table 4-3 Support information locations (continued)**

Service consideration	Path to access information
Component and diagnosis information, failure detection, and required action	To locate diagnosis information and actions: <ol style="list-style-type: none"><li data-bbox="703 310 1203 331">1. Go to <a href="http://www.hp.com/go/techcenter/pcdiags">http://www.hp.com/go/techcenter/pcdiags</a>.</li><li data-bbox="703 363 938 384">2. Select <b>Get Support</b>.</li><li data-bbox="703 415 1445 457">3. Near the bottom of the window, select <b>Notebook PCs</b>, and then select your location.</li></ol>

---

# 5 Removal and replacement procedures for Customer Self-Repair parts

This chapter provides removal and replacement procedures for Customer Self-Repair parts.

 **NOTE:** The Customer Self-Repair program is not available in all locations. Installing a part that is not supported by the Customer Self-Repair program can void your warranty. Check your warranty to determine whether Customer Self-Repair is supported in your location.

 **NOTE:** The [HP Support YouTube Channel](#) (in English) has videos that provide step-by-step removal and replacement instructions for many common parts and models.

---

## Component replacement procedures

To remove and replace computer components, use these procedures.

 **NOTE:** Details about your computer, including model, serial number, product key, and length of warranty, are on the service tag at the bottom of your computer.

 **NOTE:** HP continually improves and changes product parts. For complete and current information about supported parts for your computer, go to <https://partsurfer.hp.com/>, select your country or region, and then follow the on-screen instructions.

---

Make special note of each screw size and location during removal and replacement.

## Preparation for disassembly

To remove and replace computer components, use these procedures:

For initial safety procedures, see [Removal and replacement procedures preliminary requirements on page 21](#).

1. Turn off the computer. If you are unsure whether the computer is off or in Hibernation or Sleep mode, turn the computer on, and then shut it down through the operating system.
2. Disconnect the power from the computer by unplugging the power cord from the computer.
3. Disconnect all external devices from the computer.

## Bottom cover

To remove the bottom cover, use this procedure and illustration.

**Table 5-1 Bottom cover descriptions and part numbers**

Description	Spare part number
Glacier silver	P31111-001
Meteor silver	P31112-001

---

Before removing the bottom cover, prepare the computer for disassembly (see [Preparation for disassembly on page 30](#)).

Remove the bottom cover:

---

 **NOTE:** The screw type can vary. It could be either Torx T5 or Phillips.

---

1. Position the computer upside down.
2. Loosen the captive Torx T5 or Phillips screw **(1)** on the bottom cover.

---

 **NOTE:** The bottom cover includes a captive (not removable) screw that causes the cover to pop up when you loosen the screw. After the cover pops up, do not continue to loosen the captive screw.

---

3. Remove the Torx T5 or Phillips P2.0 × 7.0 screw **(2)** from the bottom cover.
4. Remove the two Torx T5 or Phillips P2.0 × 3.0 screws **(3)** from the bottom cover.

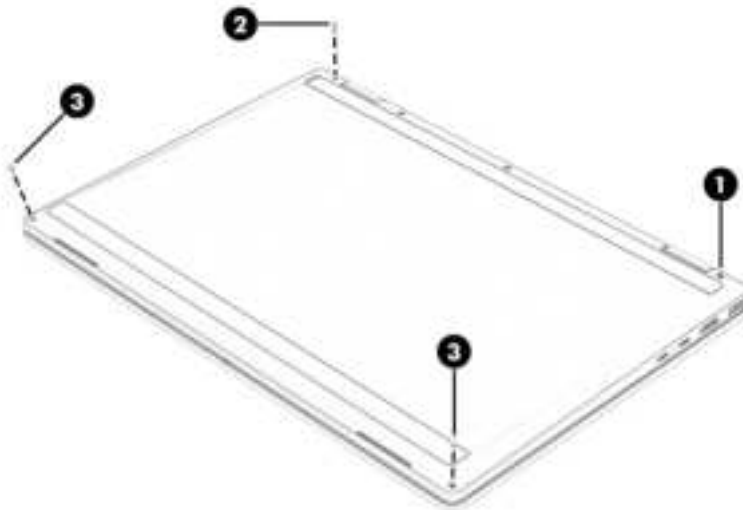

5. Insert a tool **(1)** into the seam near the top left hinge computer and release the cover.

6. Remove the cover (2) from the computer.



To replace the bottom cover, reverse the removal procedures.

When replacing the bottom cover, remove the Feature Byte label from the inside of the old bottom cover and place it on the inside of the new bottom cover. Be sure to keep this label with the computer, as the label is required for any future repairs.

You can locate product labels:

- Laser etched on the old bottom cover.
- In HP System Information by pressing **fn + esc** when you turn on the computer.

---

 **NOTE:** Bottom cover appearance might vary.

---

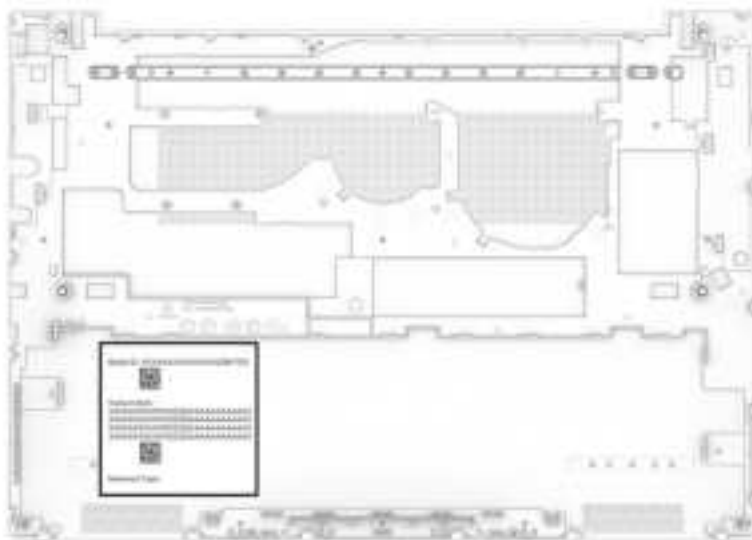

Hand write the product information onto the label of the new bottom cover. Use a ballpoint pen or marker to avoid smudging.

#### Example of label information

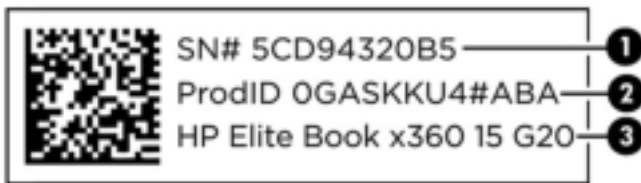

#### New bottom cover label location

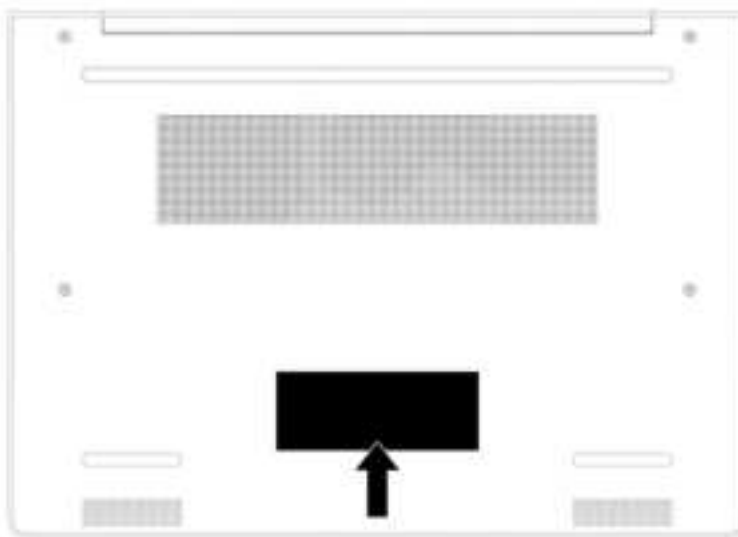

## Battery

The battery removal procedure differs depending on whether you are removing and replacing the existing battery or installing a new battery. To install a new battery, you must use a revive kit.

- To remove and replace the existing battery, see [Removing and reinstalling the same battery on page 33](#).
- To install a new battery, see [Installing a new battery on page 35](#).

### Removing and reinstalling the same battery

To remove the battery and reinstall it, use this procedure and illustration.

**⚠ WARNING!** To avoid personal injury and damage to the product:

- Do *not* puncture, twist, or crack the battery.
- Do *not* cause an external puncture or rupture to the battery, which can cause a short inside the battery that can result in battery thermal runaway.

- Do *not* handle or touch the battery enclosure with sharp objects such as tweezers or pliers, which might puncture the battery.
- Do *not* compress or squeeze the battery case with tools or heavy objects stacked on top of the case. These actions can apply undue force on the battery.
- Do *not* touch the connectors with any metallic surface or object, such as metal tools, screws, or coins, which can cause shorting across the connectors.

---

For additional battery information, see the *Regulatory, Safety, and Environmental Notices*. To access this guide, select the **Search** icon in the taskbar, type `HP Documentation` in the search box, and then select **HP Documentation**.

Before removing the battery, follow these steps:

1. Prepare the computer for disassembly (see [Preparation for disassembly on page 30](#)).
2. Remove the bottom cover (see [Bottom cover on page 30](#)).

---

**WARNING!** To reduce potential safety issues, use only the user-replaceable battery provided with the computer, a replacement battery provided by HP, or a compatible battery purchased from HP.

**IMPORTANT:** Removing a battery that is the sole power source for the computer can cause loss of information. To prevent loss of information, save your work or shut down the computer through Windows before you remove the battery.

---

Remove the battery:

1. Disconnect the battery cable (1) from the system board.

---

**NOTE:** You can disconnect the battery cable from the battery.

2. Remove the six Phillips M2.0 × 3.5 screws (2) that secure the battery to the computer.
3. Remove the battery (3) from the computer.

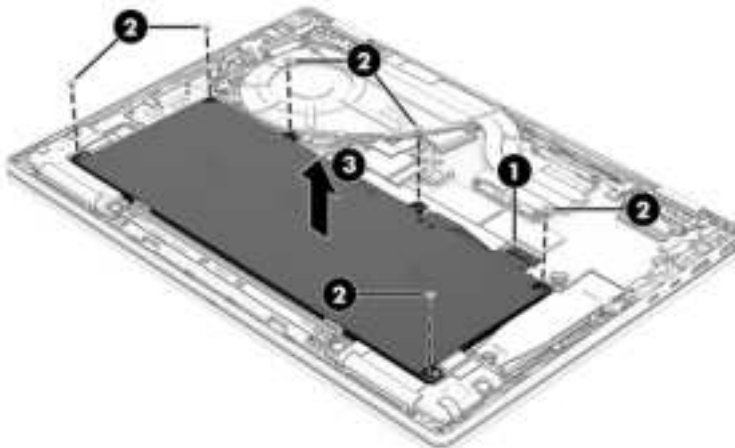

To reinstall the battery, reverse the removal procedures.

---

**NOTE:** When replacing the battery, be sure to completely reassemble the computer and plug in the AC adapter before turning the computer on.

## Installing a new battery

To install a battery, use these procedures and illustrations. You must use a revive kit to remove the old battery and install a new one. The revive kit includes an empty containment tray and a containment tray with a battery preinstalled.

**Table 5-2 Battery description and part number**

Description	Spare part number
Battery, 3 cell, 59 Whr (includes revive kit)	N66215-001
Battery cable (available in the Cable Kit)	P31092-001

Before starting this replacement procedure:

- Ensure other individuals are sufficiently clear of your workspace.
- Ensure your workspace is clear of any flammable material such as paper or oils.
- Locate the nearest ABC dry chemical fire-extinguisher for use in an emergency.

 **WARNING!** This procedure requires removing the battery or disconnecting the battery cable. Use care to avoid bending, twisting, or puncturing the battery regardless of its condition. Failure to follow this replacement guide or to use HP recommended tools might damage the system and/or cause a safety hazard.

- Do *not* remove the battery from the containment tray.
- Do *not* handle or touch the battery enclosure with sharp objects such as tweezers or pliers, which might puncture the battery.
- Do *not* touch the connectors with any metallic surface or object, such as metal tools, screws, or coins, which can cause shorting across the connectors.

Should a part become stuck or difficult to remove when opening a unit where a swollen battery is suspected, or if the battery becomes stuck in the unit, stop, and contact HP Support for assistance. Do not try to remove a battery by force.

 **NOTE:** Screw locations, latch locations, and internal components might vary.

Before removing the battery, follow these steps:

1. Prepare the computer for disassembly (see [Preparation for disassembly on page 30](#)).
2. Remove the bottom cover (see [Bottom cover on page 30](#)).

 **WARNING!** To reduce potential safety issues, use only the user-replaceable battery provided with the computer, a replacement battery provided by HP, or a compatible battery purchased from HP.

 **IMPORTANT:** Removing a battery that is the sole power source for the computer can cause loss of information. To prevent loss of information, save your work or shut down the computer through Windows before you remove the battery.

1. Remove the battery using the revive kit:

- a. Disconnect the battery cable from the system board. The connector location might vary.

---

 **NOTE:** You can disconnect the cable from the battery. The battery spare part kit does not come with the battery cable, so be sure to use the old battery cable or order a new battery cable when replacing the battery.

---

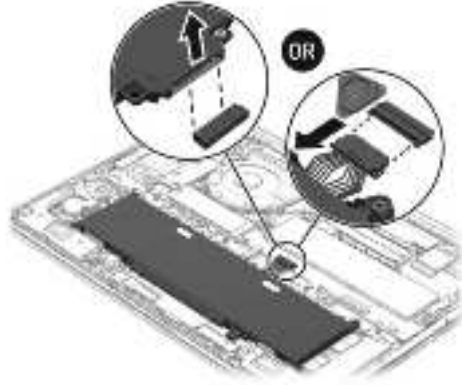

- b. Open the empty battery containment tray.



- c. Remove the paper backing layer from the adhesive on the tray.



- d. Turn the tray **(1)** over so that the adhesive is facing down.
- e. Place the tray **(2)** centered on the battery.
- f. Press down on the indentations on the tray **(3)** to adhere it to the battery.

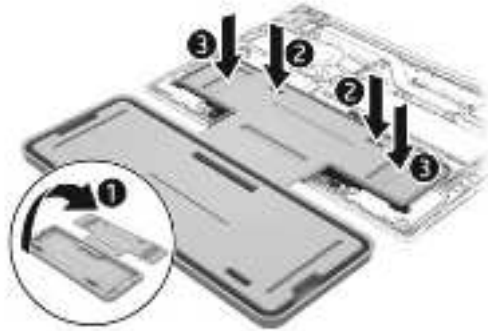

- g. Remove the Phillips screws **(1)** that secure the battery to the computer. Number of screws and screw locations might vary.
- h. Lift the top of the tray **(2)** to remove the battery from the computer.

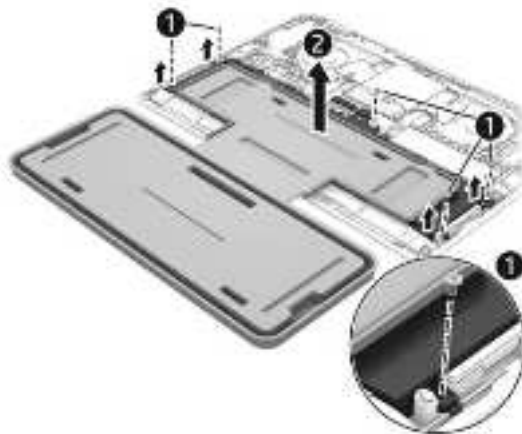

- i. Rotate the battery up and over into the cavity of the containment tray.



---

 **NOTE:** Please recycle responsibly. For more information about recycling programs, see the HP website at <http://www.hp.com/recycle>.

---

2. Install the battery using the revive kit:
  - a. Open the containment tray that includes the new battery.
  - b. Turn the tray (1) over so the battery is facing downward, and then insert the battery (2) into the computer. Adhesive secures the battery to the tray.

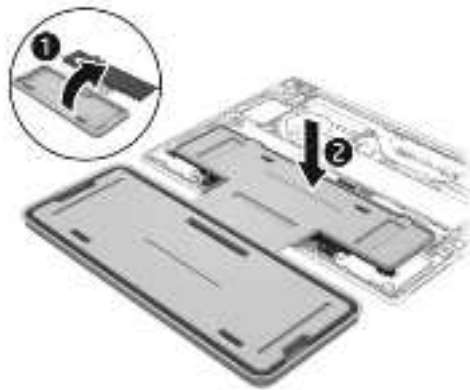

- c. Install the Phillips screws (1) to secure the battery. Number of screws and screw locations might vary.

- d. Lift the containment tray (2) off the battery.



- e. Connect the battery cable to the system board. The connector location might vary.

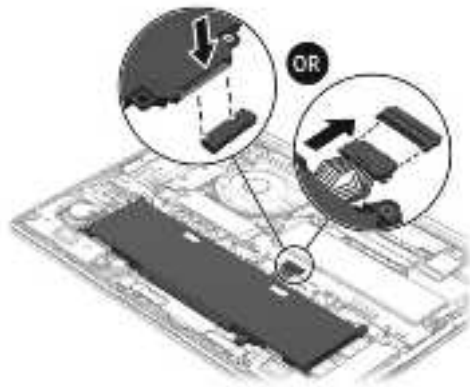

---



 **NOTE:** When replacing the battery, be sure to completely reassemble the computer and plug in the AC adapter before turning the computer on.

---

---

# 6 Removal and replacement procedures for authorized service provider parts

This chapter provides removal and replacement procedures for authorized service provider parts.

-  **IMPORTANT:** Only an authorized service provider should access the components described in this chapter. Accessing these parts can damage the computer or void the warranty.
-  **NOTE:** Details about your computer, including model, serial number, product key, and length of warranty, are on the service tag at the bottom of your computer.
-  **NOTE:** The [HP Support YouTube Channel](#) (in English) has videos that provide step-by-step removal and replacement instructions for many common parts and models.

## Component replacement procedures

To remove and replace computer components, use the procedures described in this section.

-  **NOTE:** HP continually improves and changes product parts. For complete and current information about supported parts for your computer, go to <https://partsurfer.hp.com/>, select your country or region, and then follow the on-screen instructions.

Make special note of each screw size and location during removal and replacement.

## Solid-state drive

To remove the solid-state drive (SSD), use this procedure and illustration.

**Table 6-1 SSD descriptions and part numbers**

Description	Spare part number
1 TB	N77394-005
512 GB	N77392-005
SSD thermal pad	P31093-001

Before removing the SSD, follow these steps:

1. Prepare the computer for disassembly (see [Preparation for disassembly on page 30](#)).
2. Remove the bottom cover (see [Bottom cover on page 30](#)).
3. Disconnect the battery cable from the system board (see [Removing and reinstalling the same battery on page 33](#)).

Remove the SSD:

1. Remove two Phillips M2.0 × 3.0 screws **(1)** that secure the SSD cover.

2. Lift the cover **(2)** off the SSD.

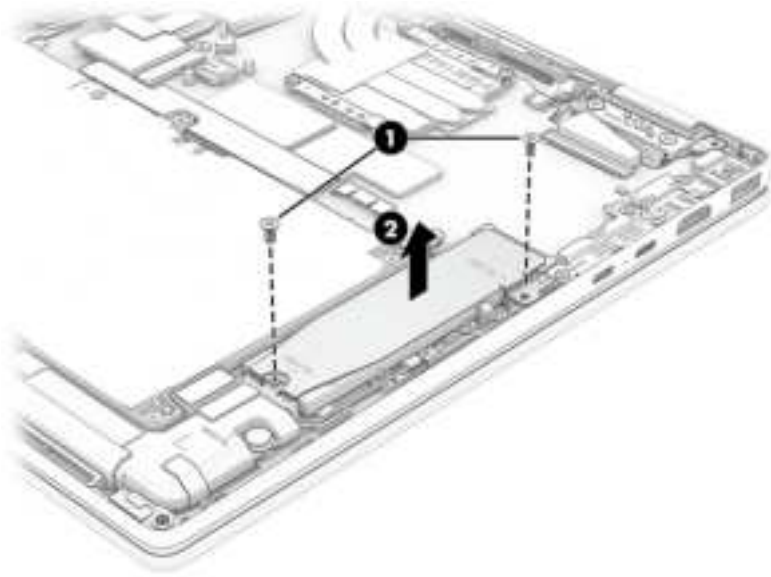

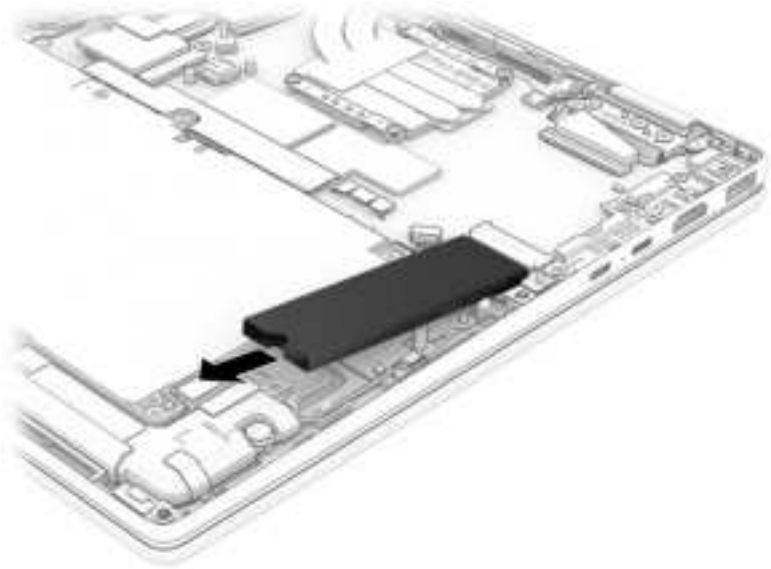

3. Pull the SSD out of the socket.

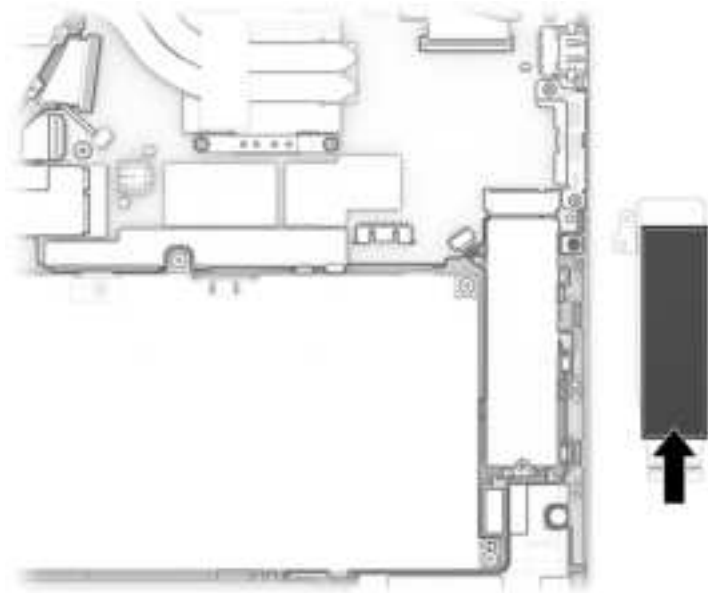

To install an SSD, reverse the removal procedures.

When installing an SSD, be sure a thermal pad is installed on the bottom of the SSD cover.



 **NOTE:** SSDs are designed with a notch to prevent incorrect insertion.

## Speakers

To remove the speakers, use this procedure and illustration.

**Table 6-2 Speaker description and part number**

Description	Spare part number
Speakers (left and right)	P31115-001

Before removing the speakers, follow these steps:

1. Prepare the computer for disassembly (see [Preparation for disassembly on page 30](#)).
2. Remove the bottom cover (see [Bottom cover on page 30](#)).
3. Disconnect the battery cable from the system board (see [Removing and reinstalling the same battery on page 33](#)).
4. Remove the SSD (see [Solid-state drive on page 40](#)).

Remove the speakers:

1. Disconnect the speaker cable **(1)** from the system board.
2. Remove the four Phillips M1.6 × 3.0 screws **(2)** that secure the speakers.
3. Remove the right speaker **(3)**.
4. Remove speaker cable **(4)** from the touchpad bracket.

5. Remove the left speaker (5) from the computer.

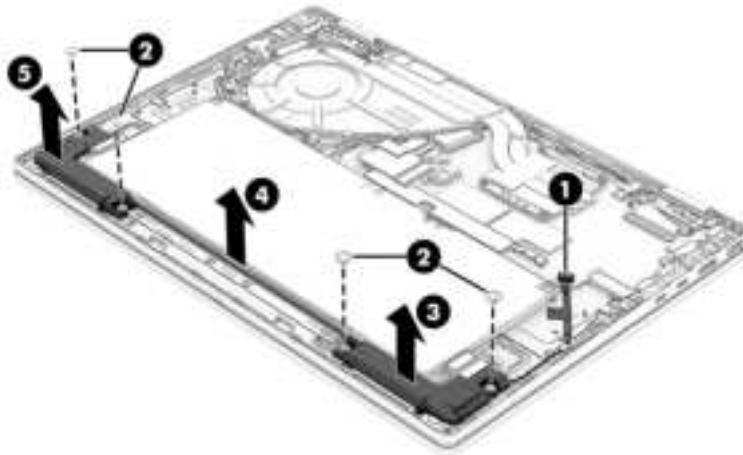

To install the speakers, reverse this procedure.

## WLAN module

To remove the WLAN module, use this procedure and illustration.

**Table 6-3 WLAN module descriptions and part numbers**

Description	Spare part number
MediaTek MT7922 Wi-Fi 6E Bluetooth 5.2	N22541-005
MediaTek MT7925 Wi-Fi 7 Bluetooth 5.4	N64647-005

**IMPORTANT:** To prevent an unresponsive system, replace the wireless module only with a wireless module authorized for use in the computer by the governmental agency that regulates wireless devices in your country or region. If you replace the module and then receive a warning message, remove the module to restore device functionality, and then contact technical support.

Before removing the WLAN module, follow these steps:

1. Prepare the computer for disassembly ([Preparation for disassembly on page 30](#)).
2. Remove the bottom cover (see [Bottom cover on page 30](#)).
3. Disconnect the battery cable from the system board (see [Removing and reinstalling the same battery on page 33](#)).

Remove the WLAN module:

1. Remove the antenna protector (1) from the module.
2. Disconnect the antenna cables (2) from the module terminals.
3. Remove the Phillips M2.0 × 3.0 screw (3) that secures from the WLAN module.

4. Remove the module (4) by pulling it away from the slot at an angle.

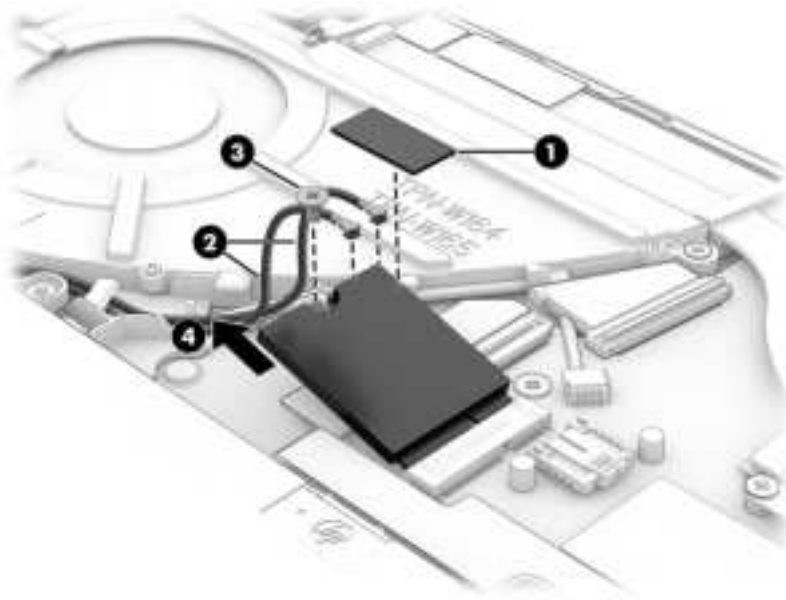

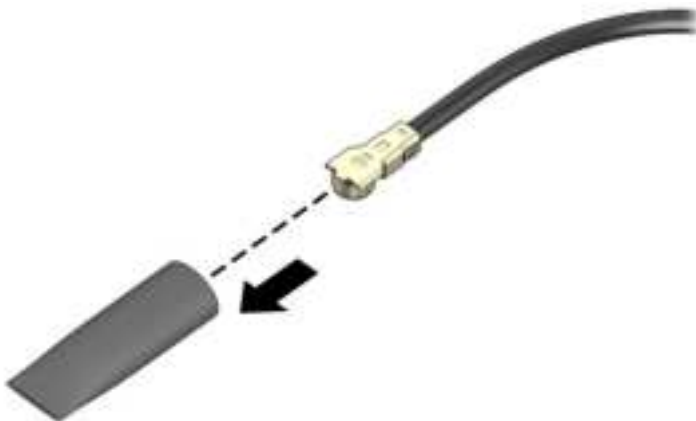

5. If the WLAN antenna is not connected to the terminal on the WLAN module, install a protective sleeve on the antenna connector, as shown in the following illustration.

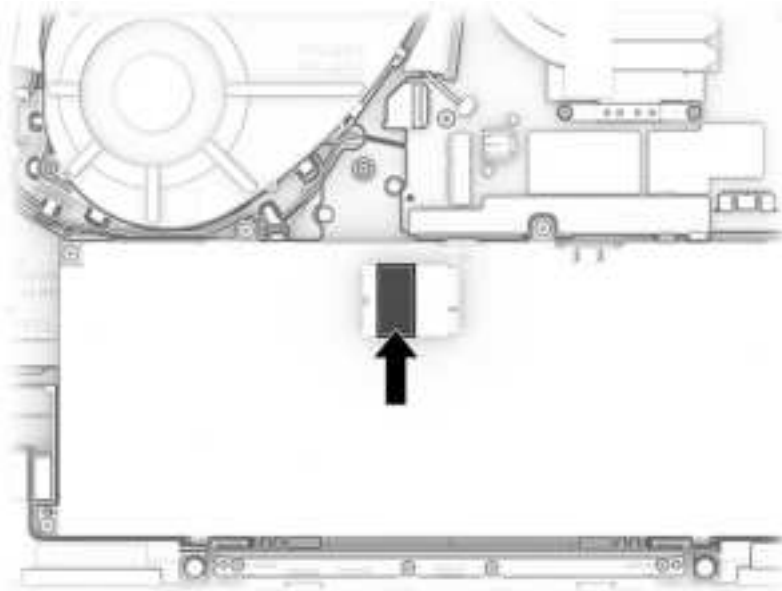

To install the WLAN module, reverse this procedure.

When installing a WLAN module, be sure that a thermal pad is installed on the bottom of the module.



 **NOTE:** WLAN modules are notched to prevent incorrect installation.

## Touchpad

To remove the touchpad, use this procedure and illustration.

**Table 6-4 Touchpad descriptions and part numbers**

Description	Spare part number
Touchpad, glacier silver	P31107-001
Touchpad, meteor silver	P31108-001
Touchpad cable (available in the Cable Kit)	P31092-001

Before removing the touchpad, follow these steps:

1. Prepare the computer for disassembly (see [Preparation for disassembly on page 30](#)).
2. Remove the bottom cover (see [Bottom cover on page 30](#)).
3. Remove the battery (see [Removing and reinstalling the same battery on page 33](#)).

Remove the touchpad:

1. Remove the four Phillips M2.0 × 3.0 screws **(1)** from the touchpad bracket.
2. Lift the speaker cable **(2)** up enough to remove the bracket.

3. Remove the bracket **(3)** from the computer.

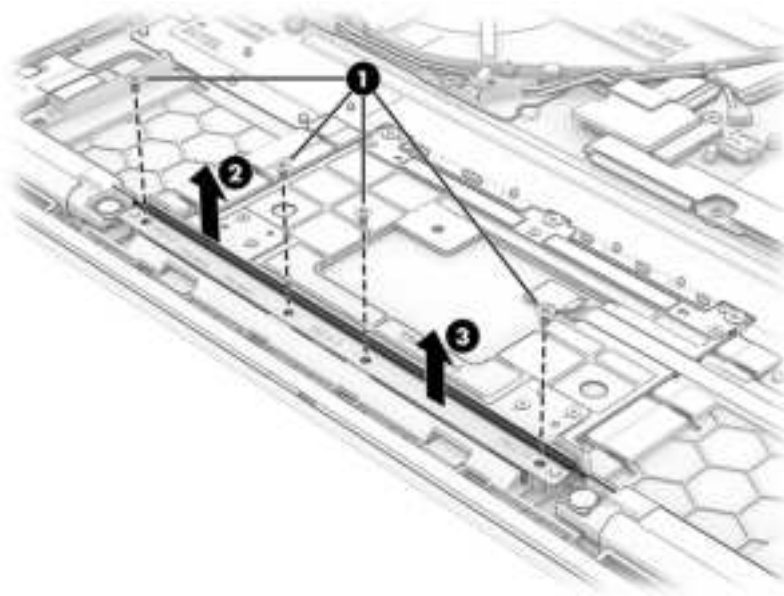

4. Remove any tape that covers the touchpad connector.
5. Disconnect the cable from the ZIF connector **(1)** on the touchpad.
6. Remove the three Phillips M2.0 × 2.0 screws **(2)** from the touchpad.
7. Remove the touchpad **(3)** from the computer.

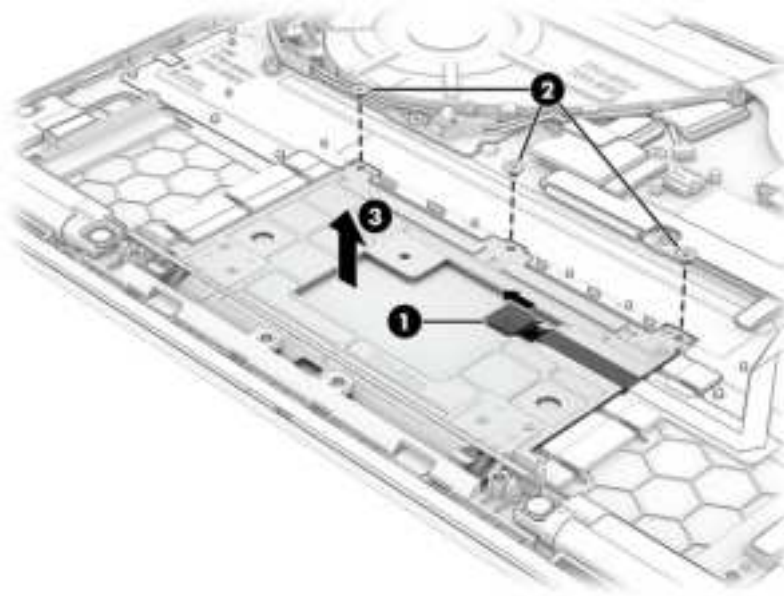

To install the touchpad, reverse the removal procedures.

## I/O board

To remove the I/O board, use this procedure and illustration.

**Table 6-5** I/O board description and part number

Description	Spare part number
I/O board (includes cable)	P31160-001

Before removing the I/O board, follow these steps:

1. Prepare the computer for disassembly (see [Preparation for disassembly on page 30](#)).
2. Remove the bottom cover (see [Bottom cover on page 30](#)).
3. Disconnect the battery cable from the system board (see [Removing and reinstalling the same battery on page 33](#)).

Remove the I/O board:

1. Lift the tape **(1)** off the connector on the board.
2. Disconnect the cable from the ZIF connector **(2)** on the board.
3. Remove the two Phillips M2.0 × 4.0 screws **(3)** from the board.
4. Pull the board **(4)** up and into the computer to remove it.

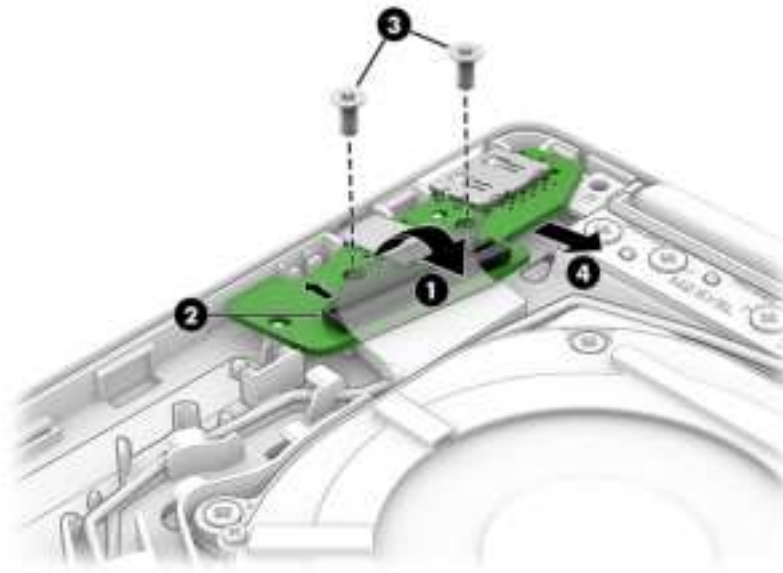

To install the I/O board, reverse this procedure.

## Fan

To remove the fan, use this procedure and illustration.

**Table 6-6** Fan description and part number

Description	Spare part number
Fan	P31113-001

Before removing the fan, follow these steps:

1. Prepare the computer for disassembly (see [Preparation for disassembly on page 30](#)).
2. Remove the bottom cover (see [Bottom cover on page 30](#)).
3. Disconnect the battery cable from the system board (see [Removing and reinstalling the same battery on page 33](#)).

Remove the fan:

1. Remove the cables from the clips around the fan.
2. Disconnect the fan cable **(1)** from the system board.
3. Remove the three Phillips M2.0 × 4.0 screws **(2)** from the fan.
4. Lift the fan **(3)** out of the computer.

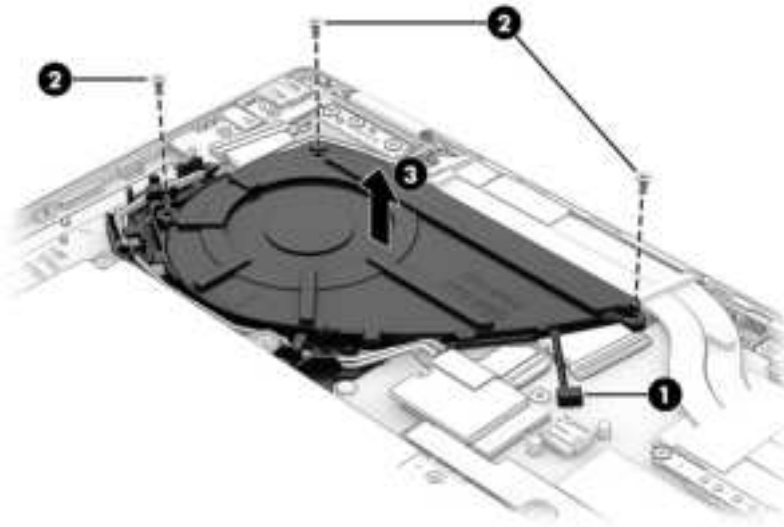

To install the fan, reverse this procedure.

After replacing the fan, use the following procedure to determine proper cable routing around the fan.

1. Connect the I/O board cable to the I/O board **(1)**.
2. Insert the cable into the clips **(2)** in the cable frame around the fan.
3. Connect the cable to the system board **(3)**.

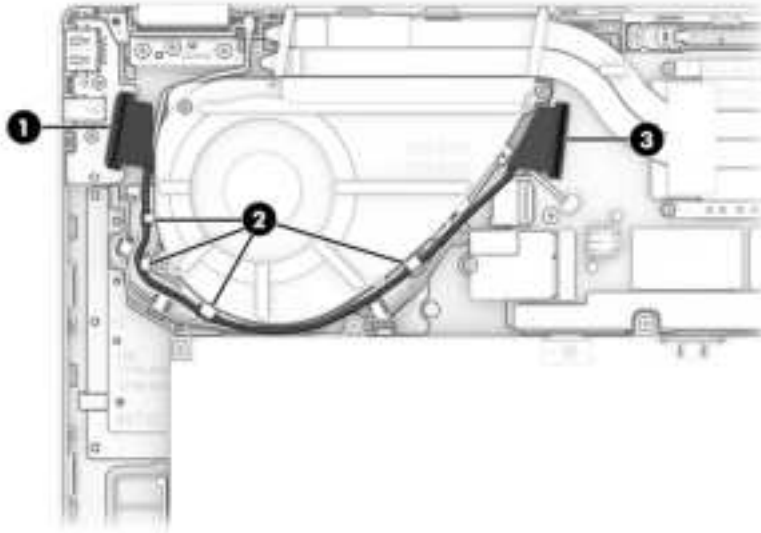

4. Insert the camera cable into the clips **(1)** in the cable frame.
5. Place the antenna cables next to or under the display cable in the same clips **(2)**
6. On the system board side, place the antenna cables against the lower side **(3)** of the cable dividing wall.
7. Connect the antenna cables to the WLAN module **(4)**
8. Place the camera cable against the upper side **(5)** of the cable dividing wall.
9. Connect the cable to the system board **(6)**.

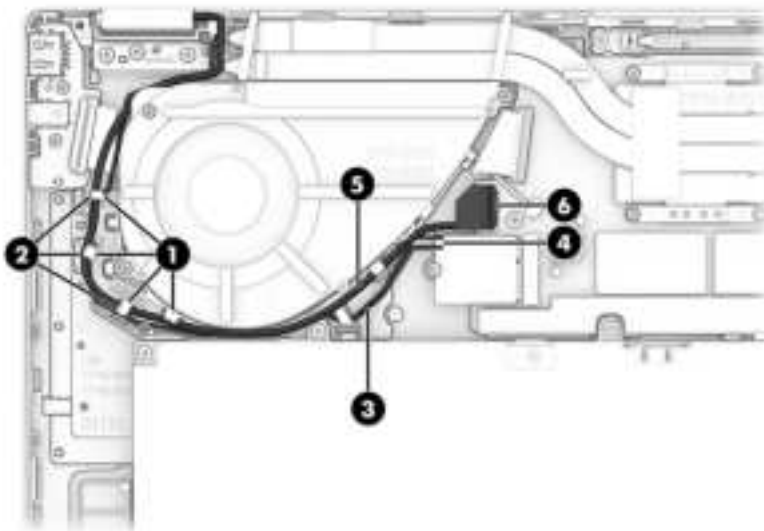

10. Install acid-free tape **(1)** onto the fan and across the cables.
11. Ensure the tape aligns with the right side of the fan boss **(2)**.

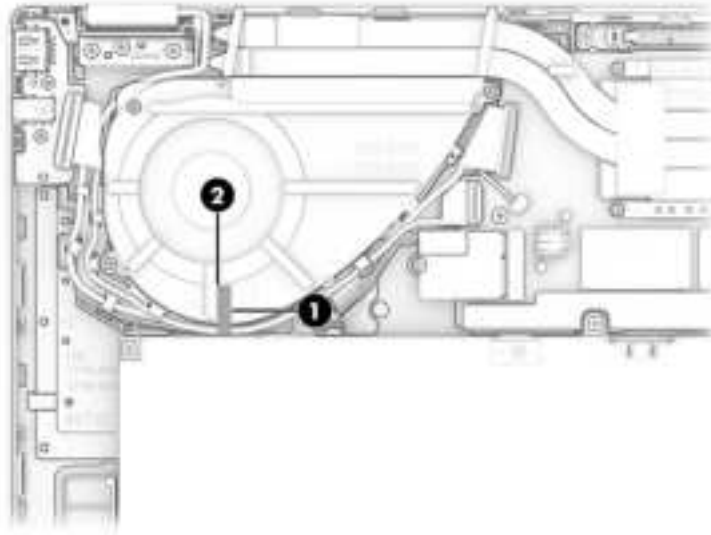

## Heat sink

To remove the heat sink, use these procedures and illustrations.

**Table 6-7** Heat sink description and part number

Description	Spare part number
Heat sink	P31162-001

 **NOTE:** You do not have to remove the heat sink to remove the system board.

Before removing the heat sink, follow these steps:

1. Prepare the computer for disassembly (see [Preparation for disassembly on page 30](#)).
2. Remove the bottom cover (see [Bottom cover on page 30](#)).
3. Disconnect the battery cable from the system board (see [Removing and reinstalling the same battery on page 33](#)).

Remove the heat sink:

1. Remove four Phillips 2.0 × 4.0 screws **(1)** from the heat sink.

 **NOTE:** The heat sink has numbers next to the screws that indicate installation order. When removing the heat sink, remove the screws in reverse order from what is shown on the heat sink. When installing a heat sink, install the screws in the order shown on the heat sink.

2. Remove the heat sink (2).

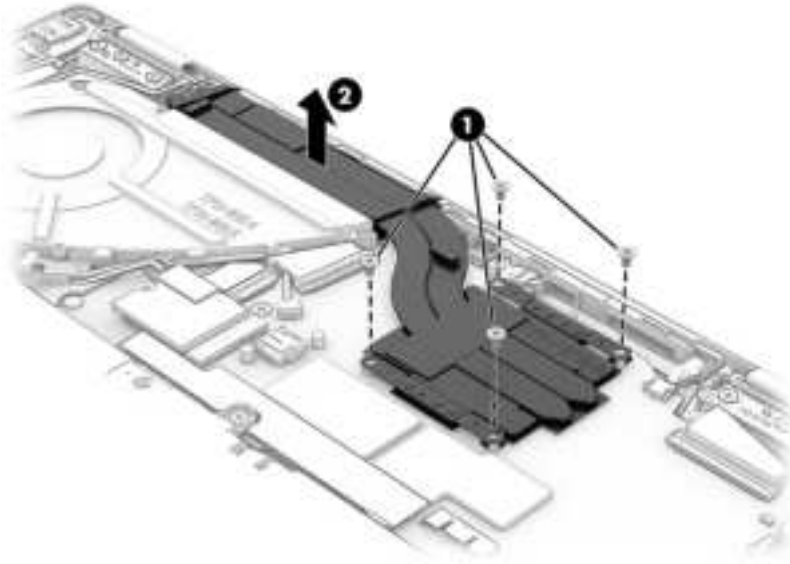

3. Thoroughly clean the thermal paste from the surfaces of the heat sink and the system board components each time the heat sink is removed.

Gray thermal grease (1) and thermal pads (2) are used on the heat sink.

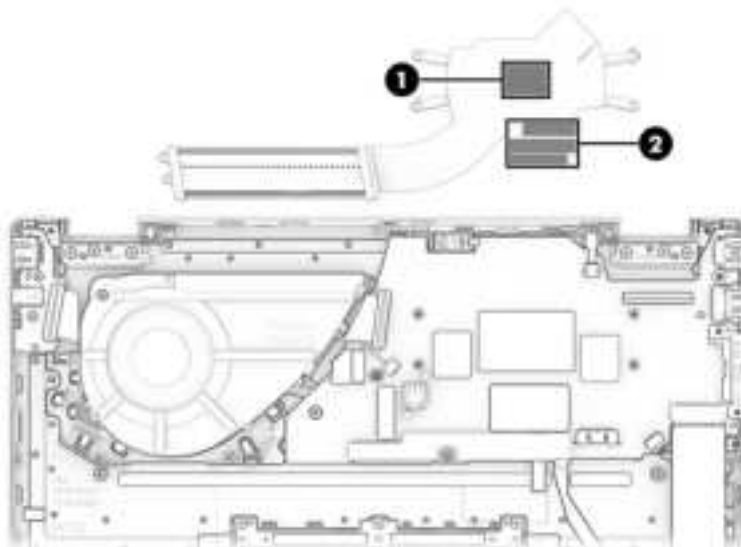

To install the heat sink, reverse this procedure.

## System board

To remove the system board, use these procedures and illustrations.

**Table 6-8 System board descriptions and part numbers**

Description	Spare part number
<b>System board</b> (includes processor and integrated system memory; for use in models with the Windows operating system)	
AMD Ryzen AI 7 HS 350 processor and 32 GB system memory	P31155-601
AMD Ryzen AI 7 HS 350 processor and 24 GB system memory	P31154-601
AMD Ryzen AI 7 HS 350 processor and 16 GB system memory	P31153-601
AMD Ryzen AI 7 350 processor and 32 GB system memory	P31151-601
AMD Ryzen AI 7 350 processor and 24 GB system memory	P31150-601
AMD Ryzen AI 7 350 processor and 16 GB system memory	P31149-601
AMD Ryzen AI 5 HS 340 processor and 16 GB system memory	P31152-601
AMD Ryzen AI 5 340 processor and 16 GB system memory	P31148-601

 **NOTE:** You do not have to remove the heat sink to remove the system board.

Before removing the system board, follow these steps:

1. Prepare the computer for disassembly (see [Preparation for disassembly on page 30](#)).
2. Remove the bottom cover (see [Bottom cover on page 30](#)).
3. Disconnect the battery cable from the system board (see [Removing and reinstalling the same battery on page 33](#)).
4. Remove the solid-state drive (see [Solid-state drive on page 40](#)).
5. Remove the WLAN module (see [WLAN module on page 43](#)).

#### **EVO/ICPS recovery**

If a system recovery fails after replacing the system board, follow the instructions in the service advisory located at [System Recovery Service Advisory](#).

Remove the system board:

1. Remove the cover from the system board.

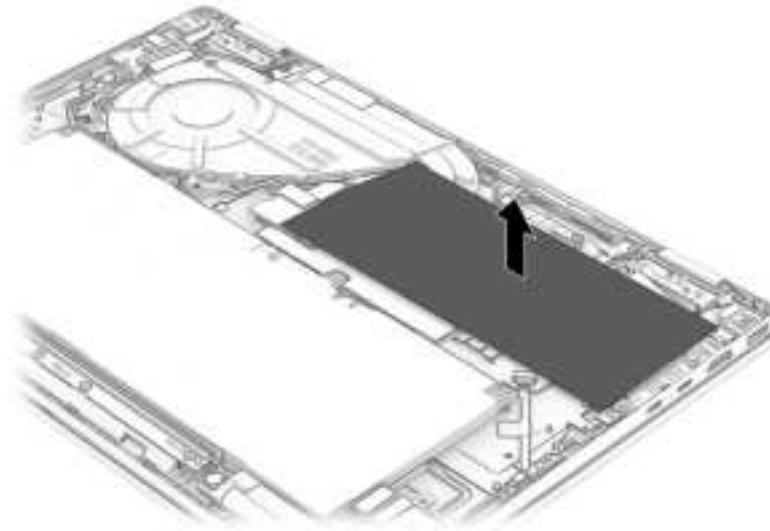

2. Disconnect the following cables from the system board:

---

 **NOTE:** Some connectors are covered by transparent tape.

---

- Camera cable (ZIF) **(1)**
- I/O board cable (ZIF) **(2)**
- Fan cable **(3)**
- IR board cable (ZIF) **(4)**
- Display cable (ZIF) **(5)**
- Speaker cable **(6)**
- Touchpad cable (ZIF) **(7)**
- Keyboard backlight cable (ZIF) **(8)**
- Keyboard cable (ZIF) **(9)**

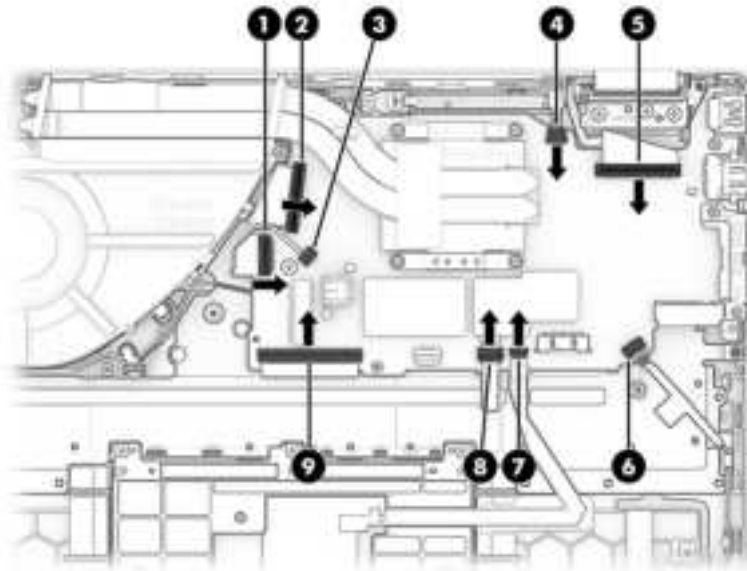

3. Remove the Phillips M2.0 × 2.0 screw **(1)** and the three Phillips M2.0 × 4.0 screws **(2)** from the system board.

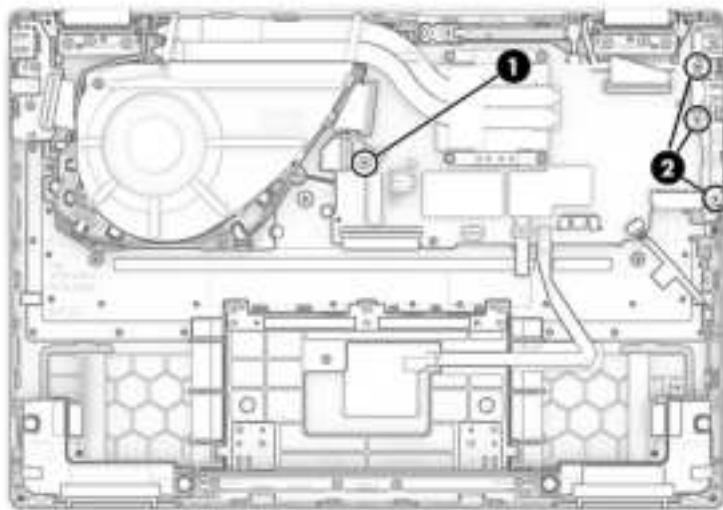

4. Lift the left side of the system board (1) up, and then pull the board (2) to the left to remove it from the computer.

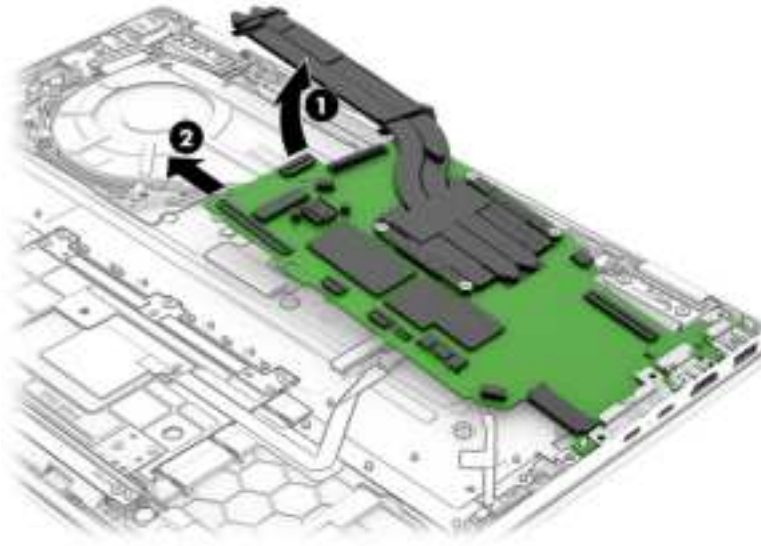

To install a system board, reverse this procedure.

When installing a system board, after connecting the touchpad, keyboard, and keyboard backlight cables to the system board, place protective tape over the connectors.

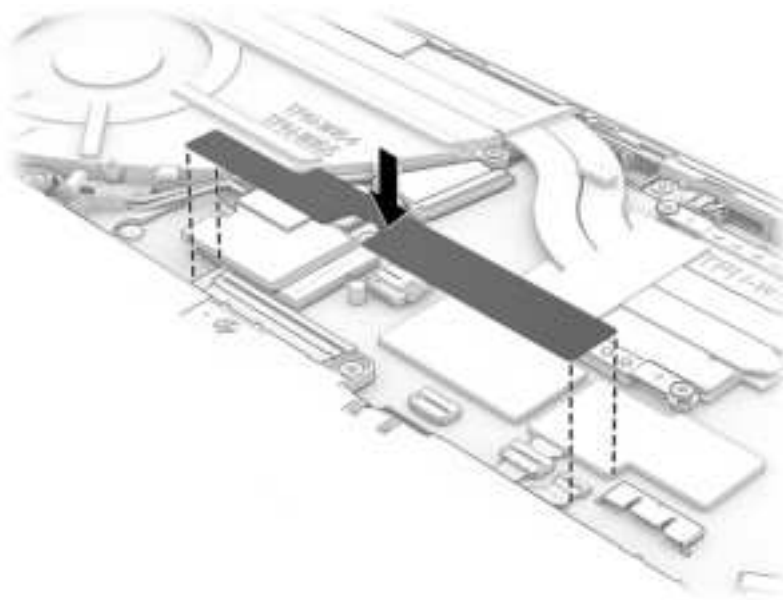

Reinstall the system board cover by positioning the left and bottom sides of the cover up against the right side of the camera connector (1) and the bottom of the WLAN connector (2).

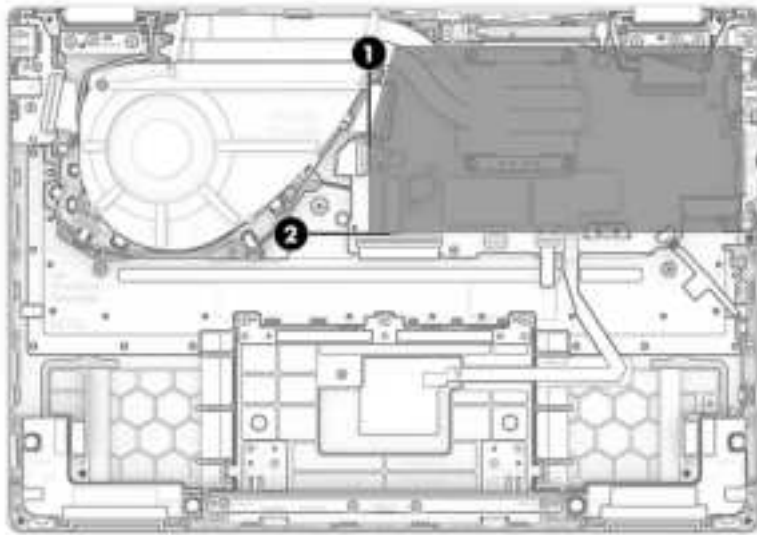

## Infrared (IR) sensor board

To remove the IR sensor board, use this procedure and illustration.

**Table 6-9** IR sensor board description and part number

Description	Spare part number
IR sensor board (includes cable)	P31161-001

Before removing the IR sensor board, follow these steps:

1. Prepare the computer for disassembly (see [Preparation for disassembly on page 30](#)).
2. Remove the bottom cover (see [Bottom cover on page 30](#)).
3. Disconnect the battery cable from the system board (see [Removing and reinstalling the same battery on page 33](#)).
4. Remove the system board (see [System board on page 51](#)).

Remove the IR sensor board:

1. Remove any tape that covers the IR sensor board connector.
2. Disconnect the cable from the ZIF connector **(1)** on the IR sensor board.
3. Remove the Phillips M2.0 x 2.0 screw **(2)** from the board.

4. Remove the board **(3)** from the computer.

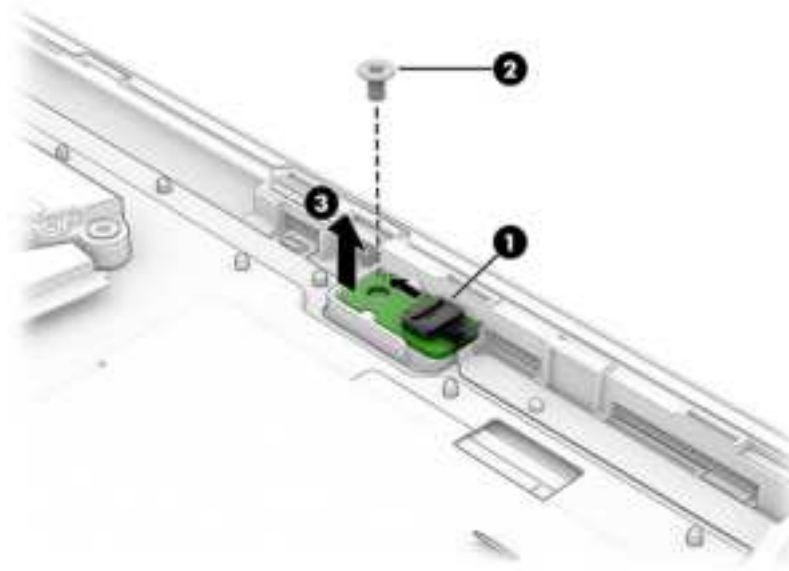

To install the IR sensor board, reverse this procedure.

## Display assembly

To remove and disassemble the display assembly, use these procedures and illustrations.

---

 **NOTE:** The display assembly is only available as spare parts at the subcomponent level. For display assembly spare part information, see the individual removal subsections.

---

Before removing the display panel, follow these steps:

1. Prepare the computer for disassembly (see [Preparation for disassembly on page 30](#)).
2. Remove the bottom cover (see [Bottom cover on page 30](#)).
3. Disconnect the battery cable from the system board (see [Removing and reinstalling the same battery on page 33](#)).

Remove the display assembly:

1. Disconnect the camera cable from the ZIF connector **(1)** on the system board.
2. Remove the plastic antenna protector **(2)** from the WLAN module.
3. Disconnect the antenna cables **(3)** from the WLAN module.
4. Remove the antenna cables and camera cable from the clips **(4)** around the fan.

5. Remove the cables (5) from clip at the top of the computer next to the hinge.

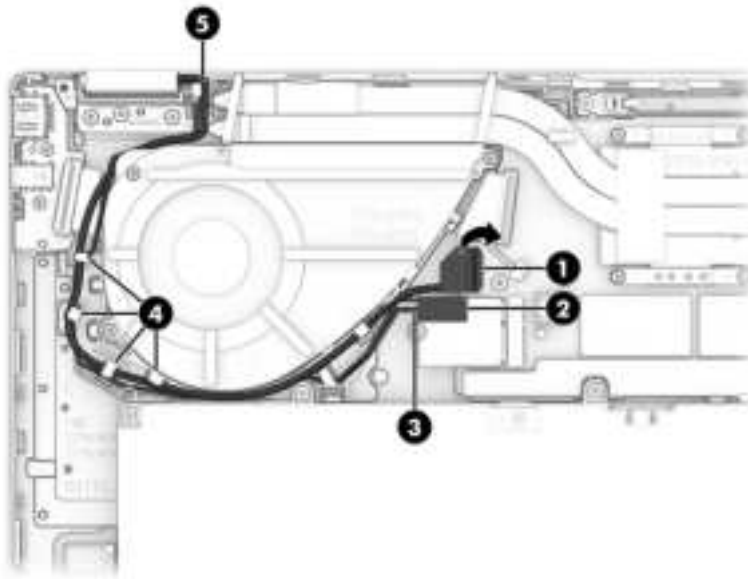

6. Lift the tape (1) off the display connector on the system board.
7. Disconnect the display cable (2).
8. Remove the display cable from the clip (3) at the top of the computer next to the hinge.

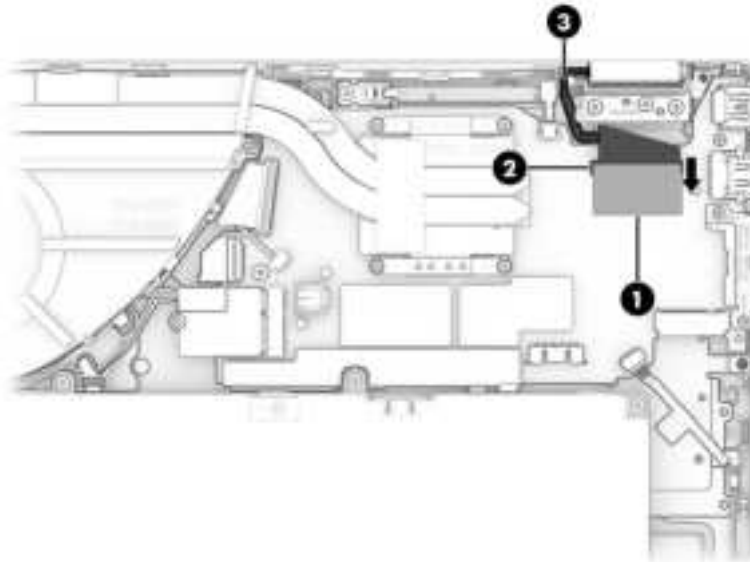

9. Remove the six Phillips M2.5 × 5.0 screws that secure the display assembly to the computer.

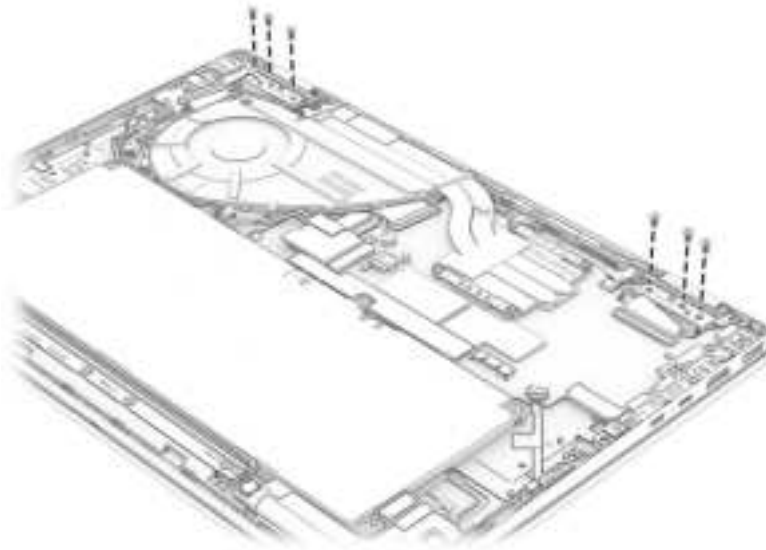

10. Open the display (1).
11. Separate the display (2) from the computer.



12. To remove the display panel:
  - a. Separate the panel (1) from the cover by prying starting in the top middle of the display to release the hooks across the top of the display.
  - b. Use tweezers (2) to grasp the hole in the tape, and then pull the tape (3) out from both sides of the panel.

- c. Separate the panel (4) from the display rear cover.

Display panels are available as spare part number P31157-001 for 2.8K OLED panels and P31156-001 for WUXGA LED panels.



- d. When installing a display panel, use the following illustration to determine tape installation locations on the inside of the display rear cover.

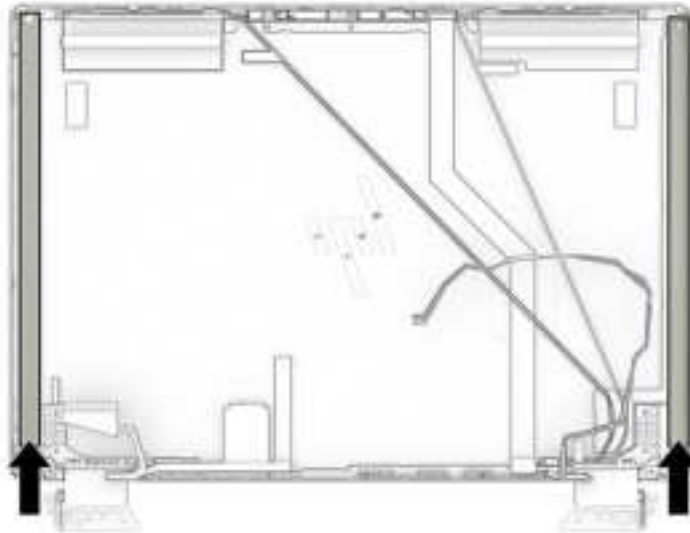

- 13. To remove the touch control board:

- a. (OLED models only) Peel the foil up off the bottom of the display to access the components underneath.

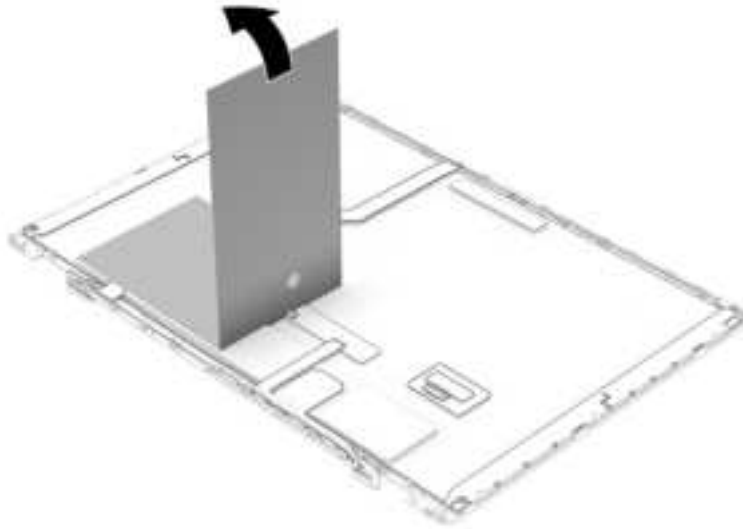

- b. Disconnect the cable from the small ZIF connector **(1)** on the touch board.
- c. Disconnect the cable from the two wide reverse ZIF connectors **(2)** on the touch board.
- d. Pull the stretchable tape **(3)** out from behind the board.
- e. Remove the touch control board **(4)**.

The touch control board is available as spare part number P31105-001.

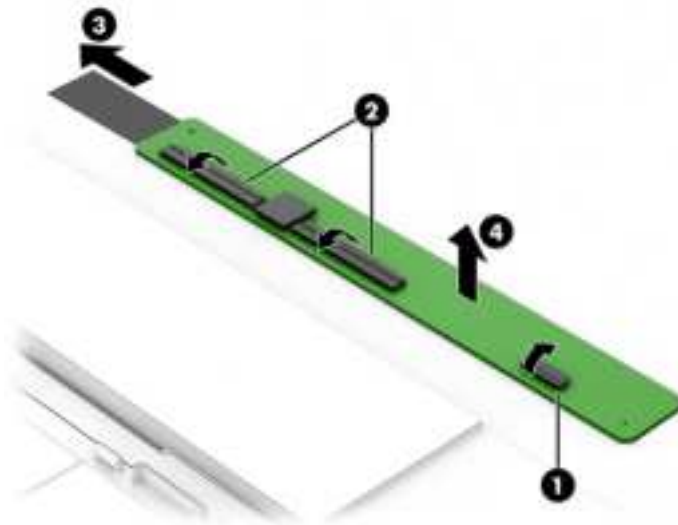

- 14. To remove the OLED board:
  - a. Disconnect the cable from the ZIF connector **(1)** on the board.
  - b. Pull the stretchable tape **(2)** out from behind the board.

- c. Remove the OLED board (3).

The OLED board is available as spare part number P31104-001.

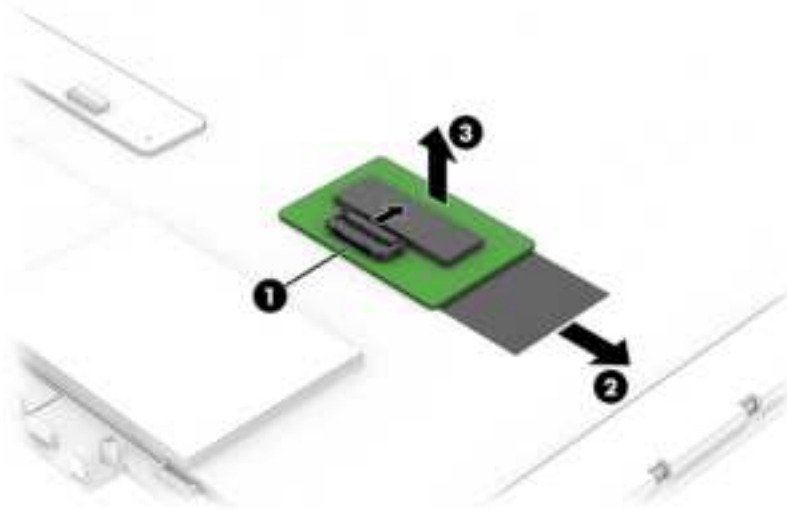

- d. When installing an OLED board, be sure that a thermal pad is installed on the board.

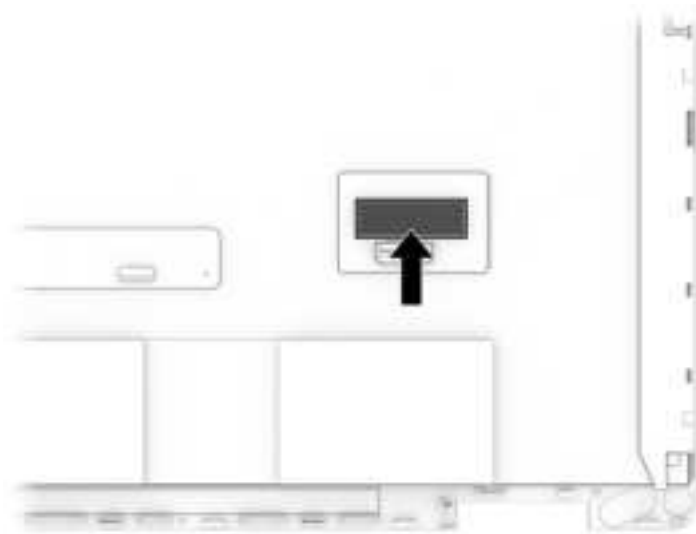

- 15. To remove the display cable:

- a. Peel the conductive tape (1) and clear tape (2) off the connector on the bottom of the panel.

- b. Open the locking bar **(3)**, and then disconnect the cable **(4)** from the panel.

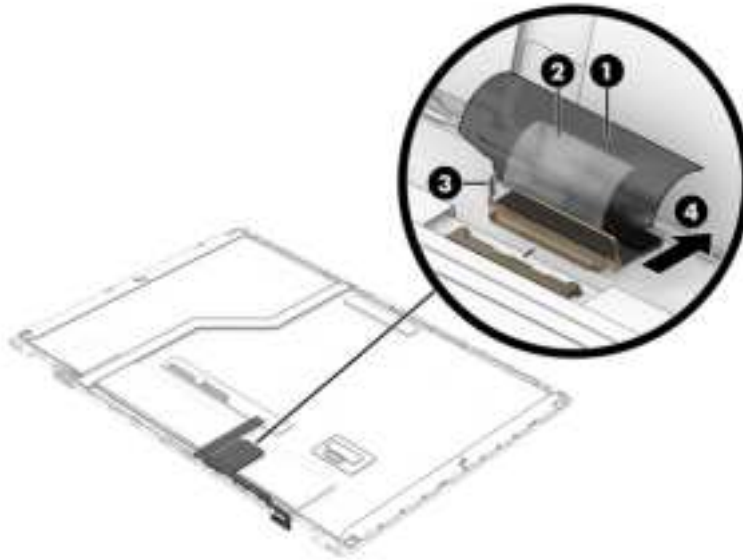

- c. Remove the black tape **(1)** that secures the cable to the display rear cover.
- d. Disconnect cable from ZIF connector **(2)** on the touch board.
- e. Disconnect cable from ZIF connector **(3)** on the OLED board.
- f. Peel the cable **(4)** off the panel.

Display cables are available as spare part number P31091-001.

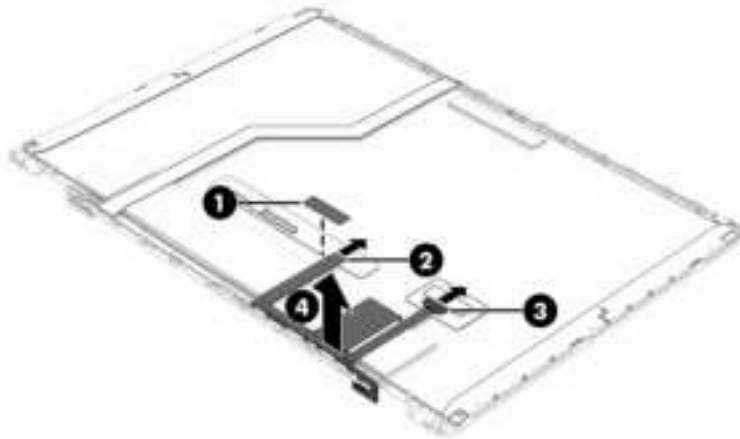

**16.** To remove the camera module:

- a. Disconnect the cable from the ZIF connector **(1)** on the camera module.
- b. Starting on the left side, insert a pry tool **(2)** under the camera module, and then pull the tool to the right **(3)** to release the module.

The camera module is available as spare part number P31109-001.

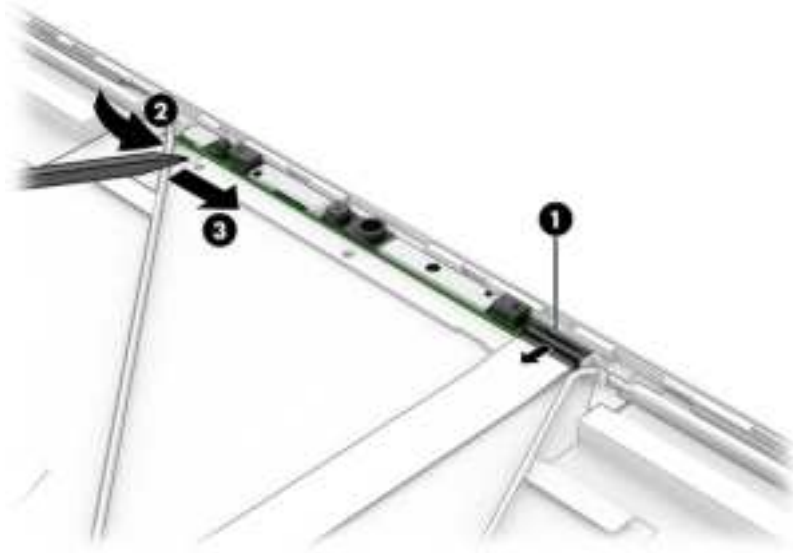

**IMPORTANT:** Camera data rewrite process

To protect sensitive data, Microsoft requires implementation of Enhanced Sign-in Security (ESS) in camera modules in HP Next Gen AI PCs. After replacing the camera module, be sure to reload the camera firmware hash, which requires unlocking Manufacturer Programming Mode (MPM). For more information, go to [hp.com/support](https://hp.com/support) and search for the following: **HP Rehash SOP for Camera with Enhanced Sign-in Security feature**.

17. To remove the camera cable:
  - a. Disconnect the cable from the ZIF connector (1) on the camera module.
  - b. Peel the cable (2) off the inside of the display rear cover.
  - c. Remove the cable (3) from the right hinge.

The camera cable is available in the Cable Kit as spare part number P31092-001.

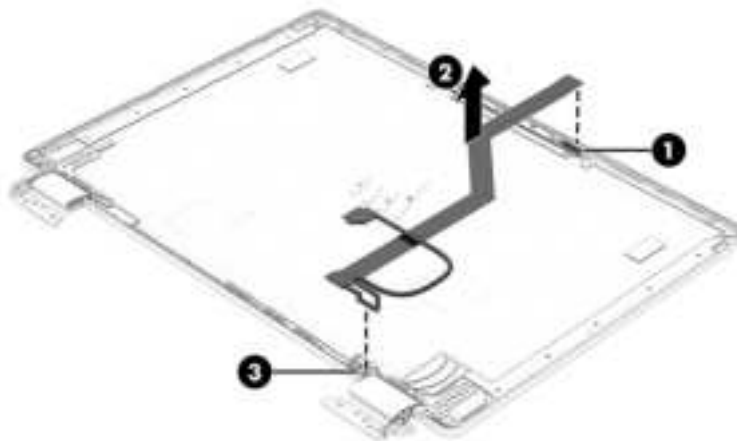

18. To remove the hinges and hinge covers from the display rear cover:

- a. Remove the three Phillips M2.0 × 2.5 screws **(1)** from each hinge.
- b. Remove the hinges **(2)** from the display rear cover.

The display hinges are available as spare part number P31100-001.

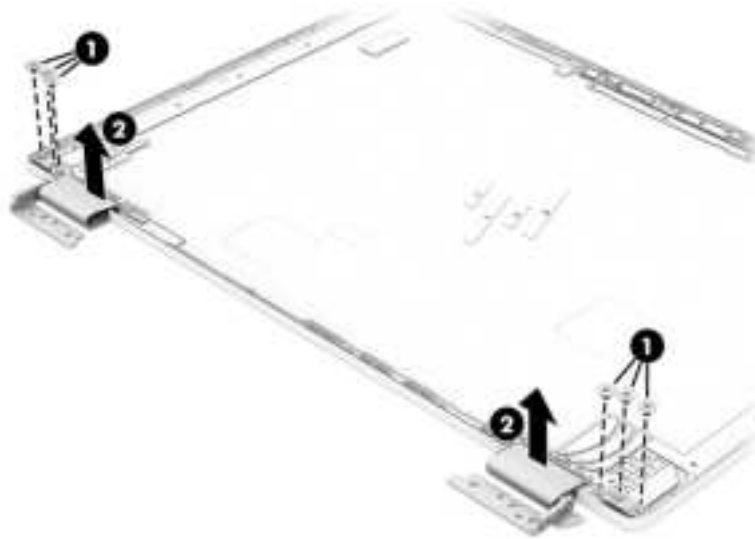

- c. Remove the Phillips M1.6 × 2.5 screw **(1)** from each hinge.
- d. Pull the covers **(2)** off the hinges.

Display hinge covers are available as the following spare part numbers:

P31101-001: Glacier silver

P32366-001: Meteor silver

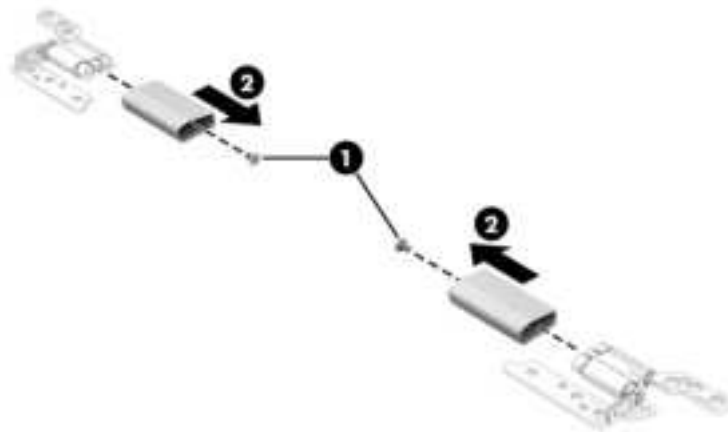

- 19. To remove the wireless antennas and cables:
  - a. Lift the foil **(1)** off the cables.
  - b. Remove the antenna cables **(2)** from the left hinge.

- c. Lift the thin gray tape **(3)** that secures the cables to the display rear cover.
- d. Peel the antennas **(4)** off the display rear cover.

The wireless cables and antennas are available in the Cable Kit as spare part number P31092-001. The wireless cables and antennas are also included in the display rear cover spare part kit.

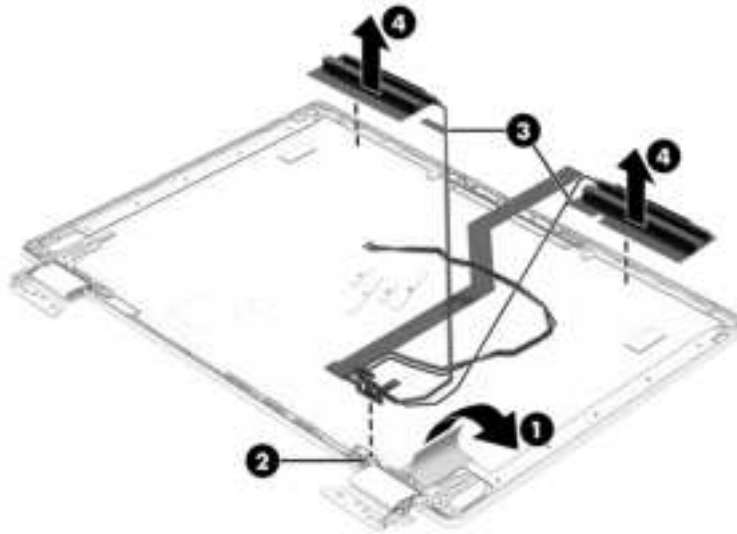

20. To install an OLED panel:

- a. Use the following illustration to identify OLED cable connectors:
  - (1): Touch control board
  - (2): Display panel
  - (3): OLED board
  - (4): System board

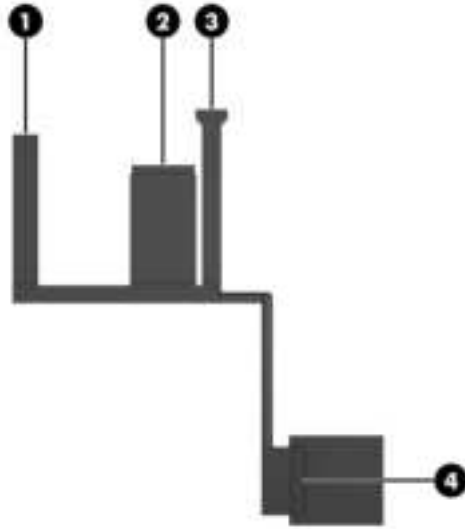

- b. To install the touch control board, install stretchable tape (1) onto the back of the board while aligning the holes (2) in the tape with the holes on both sides of the board.

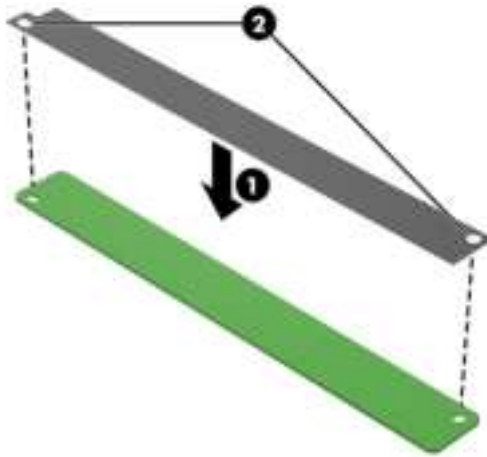

- c. Connect the wide cables to the touch control board.

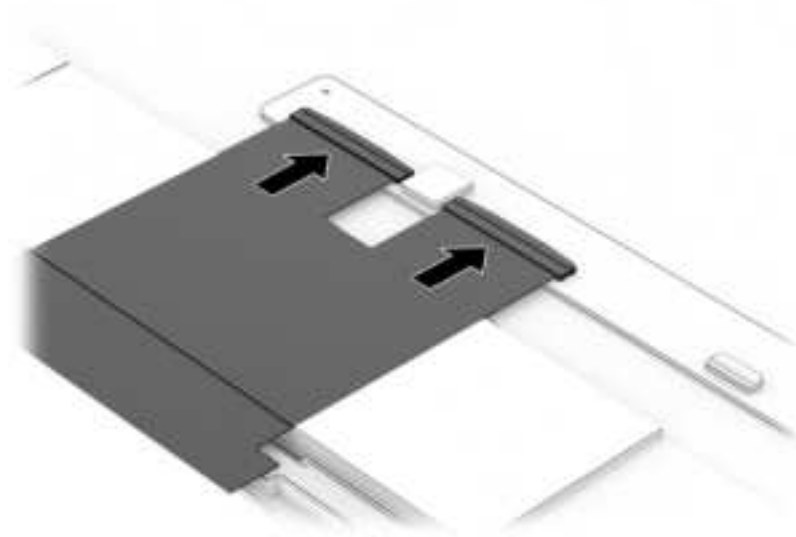

- d. Peel the backing **(1)** off the tape on the back of the touch control board.
- e. Pull the board upward **(2)** so the cables are straight.
- f. While making sure the cables are straight, place the board **(3)** onto the back of the display panel.

---

 **NOTE:** Be sure that the touch control board is placed horizontally (flat) with no tilt.

---

- g. Install the conductive tape onto the bottom right side of the board **(4)** and display panel **(5)**.

---

 **NOTE:** Align the conductive tape with the bare copper area on the bottom right corner of the touch control board.

---

Be sure that the end of the tape is exposed on the left side of the touch control board.

---

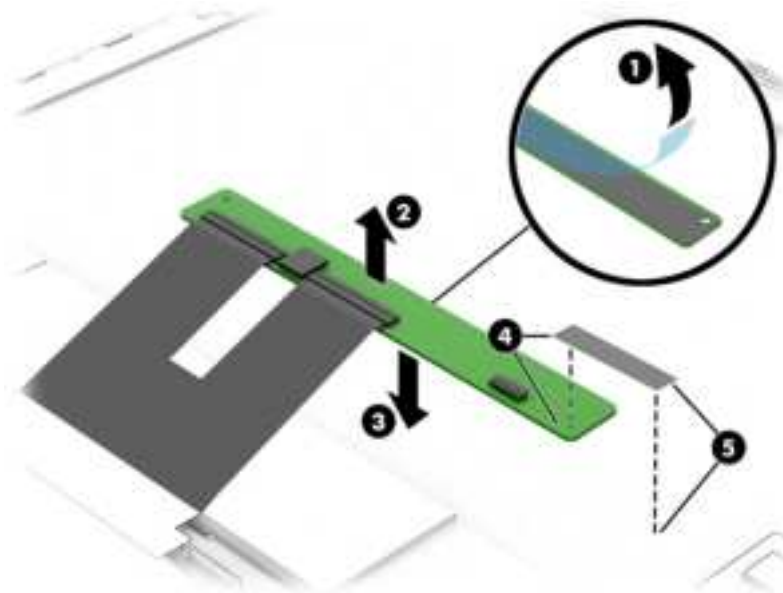

Use the following illustration to determine proper installation. Be sure that:

**(1)** The pull tape is exposed on the left side of the touch control board.

**(2)** The touch control board is installed horizontally without tilt.

**(3)** You attach conductive tape onto the bottom right side of the board. Align the conductive tape with the bare copper area on the bottom right corner of the touch control board.

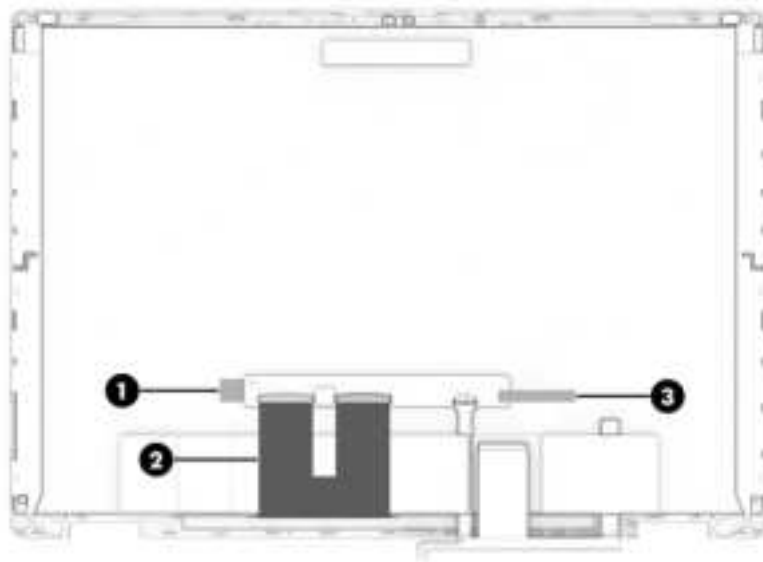

- h. Insert the OLED cable **(1)** into the connector on the back of the display panel.
- i. Rotate the locking bar **(2)** down.
- j. Install the conductive tape **(3)** that comes preinstalled on the connector. Align the tape on the cable with the open solder mask area on the touch control board.

- k. Be sure that the tape (4) covers the open solder mask area on the right end of the touch board.

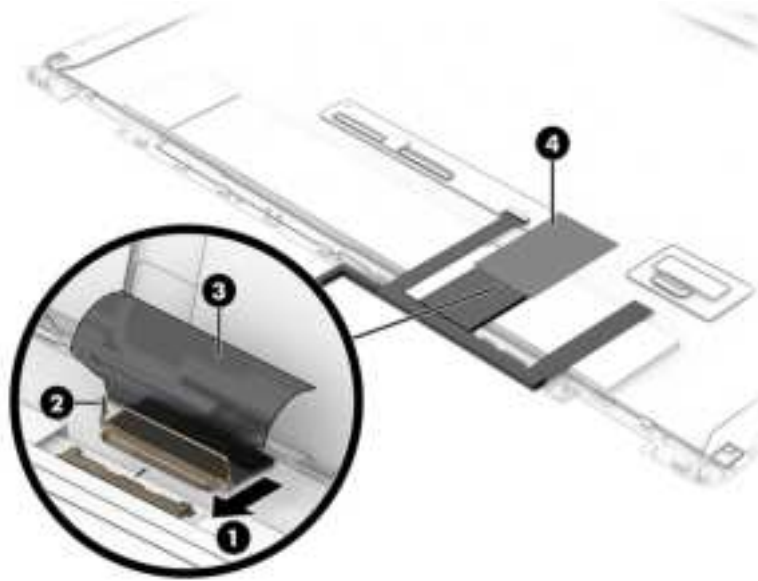

- l. Align the long thermal pad with the edge of the OLED cable, and then install the pad (1) from right to left onto the bottom of the display panel. Connect the OLED cable (2) to the touch board.

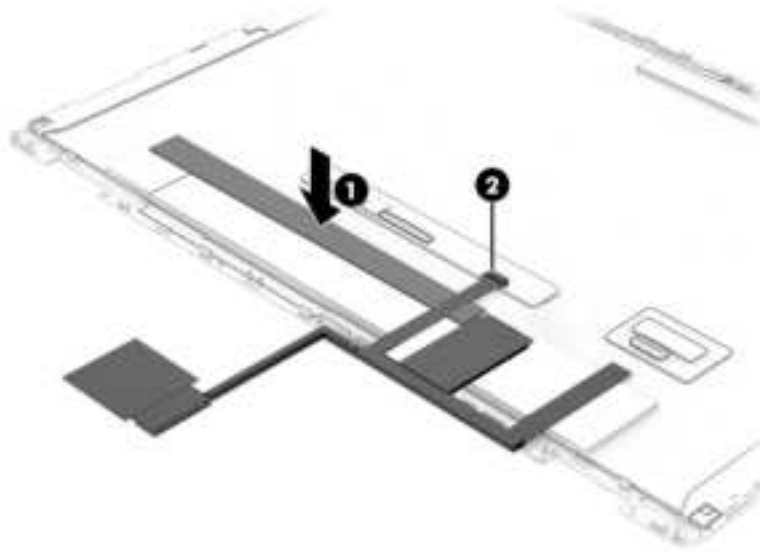

- m. Install stretchable tape onto the bottom of the OLED board up against but not covering the bare copper area behind the OLED board.

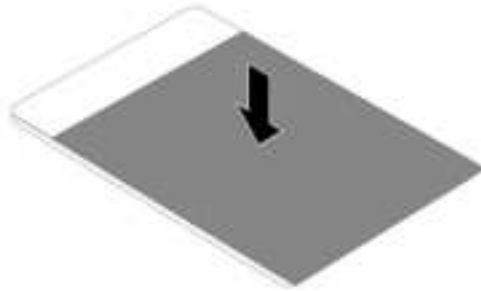

- n. Connect the OLED cable to the OLED board (1).
- o. Install the OLED board (2) onto the panel. Be sure the OLED cable is straightened and flat.
- p. Install the small thermal pad (3) on the upper part of the OLED board up against the white line.

---

 **NOTE:** Be sure that the white tab is visible on the right side of the OLED board.

---

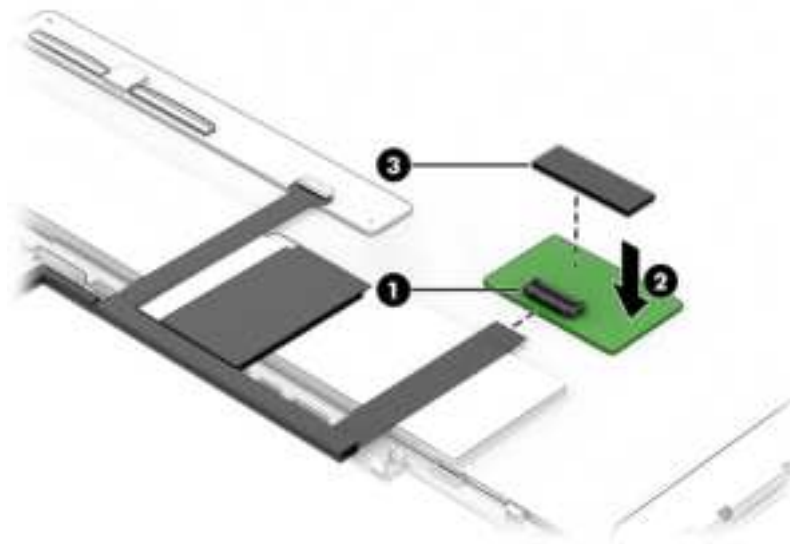

- q. Install foil onto the display panel. Be sure to apply the foil smoothly, as it cannot be tilted or wrinkled. Align the right side of the foil with the seam on the bezel.

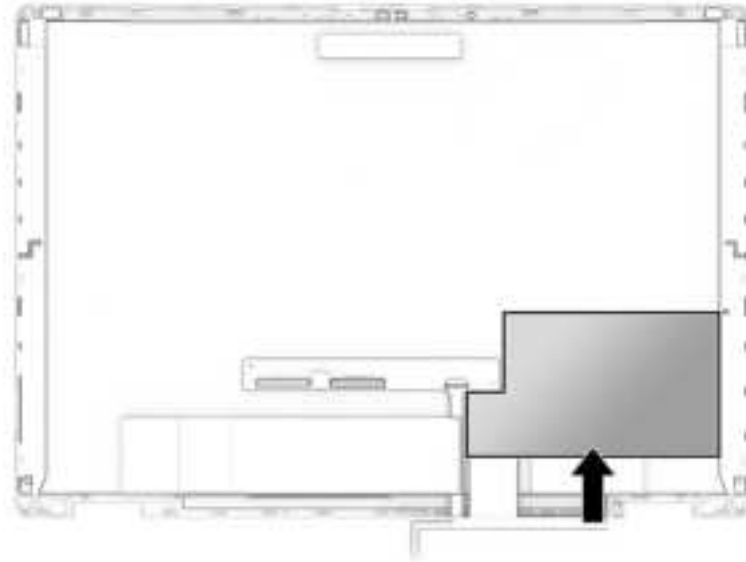

To reassemble and replace the display assembly, reverse these procedures.

After replacing the display, use the following procedure to determine proper cable routing around the fan.

1. Insert the camera cable into the clips **(1)** in the cable frame.
2. Place the antenna cables next to or under the display cable in the same clips **(2)**
3. On the system board side, place the antenna cables against the lower side **(3)** of the cable dividing wall.
4. Connect the antenna cables to the WLAN module **(4)**
5. Place the camera cable against the upper side **(5)** of the cable dividing wall.
6. Connect the cable to the system board **(6)**.

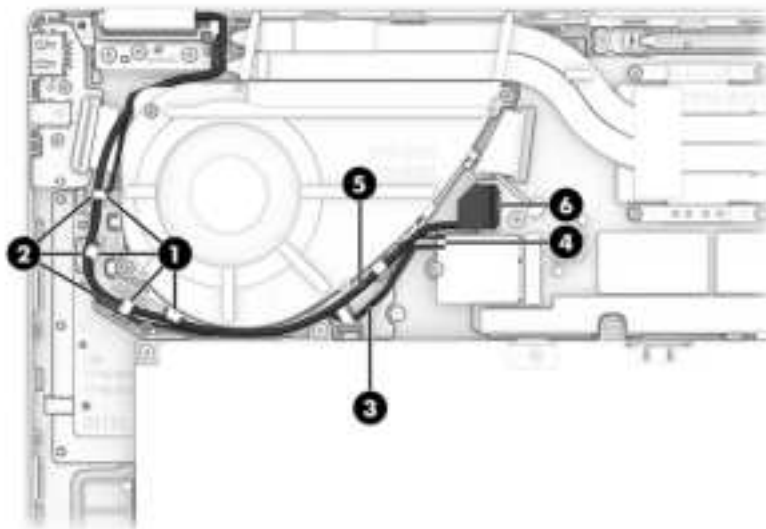

7. Install acid-free tape (1) onto the fan and across the cables.
8. Ensure the tape aligns with the right side of the fan boss (2).

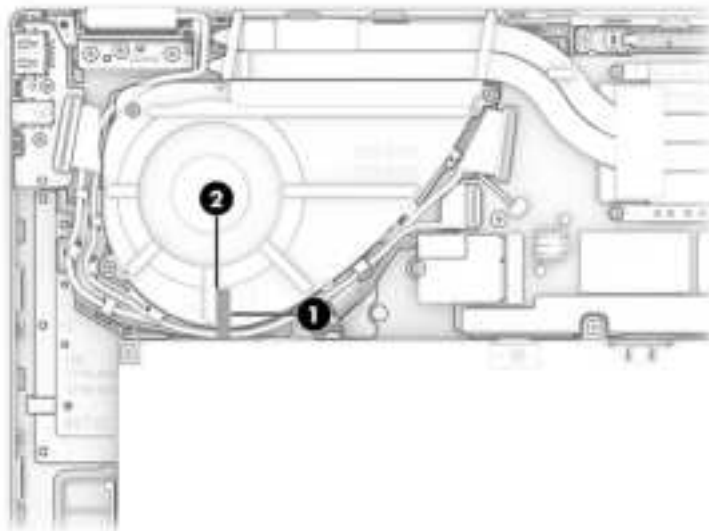

## Top cover with keyboard

The top cover with keyboard remains after removing all other spare parts from the computer. The first table includes the top cover with keyboard spare part numbers. The second table includes keyboard country codes.

**Table 6-10** Top cover with keyboard descriptions and part numbers

Description	Spare part number
Glacier silver	P31158-xx1
Meteor silver	P31159-xx1

**Table 6-11 Spare part country codes**

<b>For use in country or region</b>	<b>Spare part number</b>
Belgium	-A41
Brazil	-201
Bulgaria	-261
Chile	-161
Czech Republic/Slovakia	-FL1
Denmark	-081
Denmark, Finland, and Norway	-DH1
French Canada	-DB1
Finland/Sweden	-B71
France	-051
Germany	-041
Greece	-151
Hungary	-211
Iceland	-DD1
India	-D61
Israel	-BB1
Italy	-061
Japan	-291
The Netherlands	-B31
Northern Africa	-FP1
Norway	-091
Portugal	-131
Romania	-271
Russia	-251
Saudi Arabia	-171
Slovenia	-BA1
South Korea	-AD1
Spain	-071
Switzerland	-BG1
Taiwan	-AB1
Thailand	-281
Turkey	-141
Turkey-F	-541
Ukraine	-BD1

**Table 6-11 Spare part country codes (continued)**

<b>For use in country or region</b>	<b>Spare part number</b>
United Kingdom	-031
United States	-001

---

# 7 Using Setup Utility (BIOS)

Setup Utility, or Basic Input/Output System (BIOS), controls communication between all the input and output devices on the system (such as disk drives, display, keyboard, mouse, and printer). Setup Utility (BIOS) includes settings for the types of devices installed, the startup sequence of the computer, and the amount of system and extended memory.

---

 **NOTE:** To start Setup Utility on convertible computers, your computer must be in notebook mode and you must use the keyboard attached to your notebook.

---

## Starting Setup Utility (BIOS)

You have several ways to access the Setup Utility (BIOS).

---

 **IMPORTANT:** Use extreme care when making changes in Setup Utility (BIOS). Errors can prevent the computer from operating properly.

---

Use one of these options:

- Turn on or restart the computer and quickly press **f10**.
- Turn on or restart the computer, quickly press **esc**, and then press **f10** when the Start menu is displayed.

## Updating Setup Utility (BIOS)

Updated versions of Setup Utility (BIOS) might be available on the HP website. Most BIOS updates on the HP website are packaged in compressed files called *SoftPaqs*. Some download packages contain a file named `Readme.txt`, which contains information regarding installing and troubleshooting the file.

## Determining the BIOS version

To decide whether you need to update Setup Utility (BIOS), first determine the BIOS version on your computer.

To reveal the BIOS version information (also known as *ROM date* and *System BIOS*), use one of these options.

- HP Support Assistant
  1. Perform one of these tasks:
    - Select the **Search** icon in the taskbar, type `support` in the search box, and then select the **HP Support Assistant** app.
    - Select the question mark icon in the taskbar.
  2. Under **My notebook**, select **Specifications**.
- Setup Utility (BIOS)

1. Start Setup Utility (BIOS) (see [Starting Setup Utility \(BIOS\) on page 76](#)).
  2. Select **Main**, and then make note of the BIOS version.
  3. Select **Exit**, select one of the options, and then follow the on-screen instructions.
- In Windows, press **ctrl+alt+s**.

To check for later BIOS versions, see [Preparing for a BIOS update on page 77](#).

## Preparing for a BIOS update

Be sure to follow all prerequisites before downloading and installing a BIOS update.

 **IMPORTANT:** To reduce the risk of damage to the computer or an unsuccessful installation, download and install a BIOS update only when the computer is connected to reliable external power using the HP AC adapter provided with the computer (select products only), a replacement AC adapter provided by HP, or an AC adapter with the power rating specified on the product label. Do not download or install a BIOS update while the computer is running on battery power, docked in an optional docking device, or connected to an optional power source. During the download and installation, follow these instructions:

- Do not disconnect power from the computer by unplugging the power cord from the AC outlet.
- Do not shut down the computer or initiate Sleep.
- Do not insert, remove, connect, or disconnect any device, cable, or cord.

 **NOTE:** If your computer is connected to a network, consult the network administrator before installing any software updates, especially system BIOS updates.

## Downloading a BIOS update

After you review the prerequisites, you can check for and download BIOS updates.

1. Perform one of these tasks:
  - Select the **Search** icon in the taskbar, type `support` in the search box, and then select the **HP Support Assistant** app.
  - Select the question mark icon in the taskbar.
2. Select **Updates**. The **Checking for Updates** window opens, and Windows checks for updates.
3. Follow the on-screen instructions.
4. At the download area, follow these steps:
  - a. Identify the most recent BIOS update and compare it to the BIOS version currently installed on your computer. If the update is more recent than your BIOS version, make a note of the date, name, or other identifier. You might need this information to locate the update later, after it has been downloaded to your hard drive.
  - b. Follow the on-screen instructions to download your selection to the hard drive.

Make a note of the path to the location on your hard drive where the BIOS update is downloaded. You will need to access this path when you are ready to install the update.

## Installing a BIOS update

BIOS installation procedures vary. Follow any instructions that appear on the screen after the download is complete. If no instructions appear, follow these steps.

1. Select the **Search** icon in the taskbar, type `file` in the search box, and then select **File Explorer**.
2. Select your hard drive designation. The hard drive designation is typically Local Disk (C:).
3. Using the hard drive path you recorded earlier, open the folder that contains the update.
4. Double-click the file that has an .exe extension (for example, *filename.exe*).

The BIOS installation begins.

5. Complete the installation by following the on-screen instructions.

---



 **NOTE:** After a message on the screen reports a successful installation, you can delete the downloaded file from your hard drive.

---

---

## 8 Backing up, restoring, and recovering

You can use Windows tools or HP software to back up your information, create a restore point, reset your computer, create recovery media, or restore your computer to its factory state. Performing these standard procedures can return your computer to a working state faster.

- 
-  **IMPORTANT:** If you are performing recovery procedures on a tablet, the tablet battery must be at least 70% charged before you start the recovery process.
  -  **IMPORTANT:** For a tablet with a detachable keyboard, connect the tablet to the keyboard base before beginning any recovery process.
- 

### Backing up information and creating recovery media

These methods of creating recovery media and backups are available on select products only.

#### Using Windows tools for backing up

HP recommends that you back up your information immediately after initial setup. You can do this task either using Windows Backup locally with an external USB flash drive or using online tools.

- 
-  **NOTE:** If computer storage is 32 GB or less, Microsoft System Restore is disabled by default.
- 

#### Using the HP Cloud Recovery Download Tool to create a recovery USB flash drive (select products only)

You can use the HP Cloud Recovery Download Tool to create an HP Recovery bootable USB flash drive.

For details:

- Go to <http://www.hp.com>, search for HP Cloud Recovery, and then select the result that matches the type of computer that you have and follow the on-screen instructions.

- 
-  **NOTE:** In select countries, if you cannot create the HP Recovery USB flash drive yourself, contact support. Go to <http://www.hp.com/support>, select your country or region, and then follow the on-screen instructions.

-  **IMPORTANT:** HP recommends that you follow the [Restoring and recovery methods on page 80](#) to restore your computer before you obtain and use the HP USB flash drive. Using a recent backup can return your machine to a working state sooner than using the HP USB flash drive. After the system is restored, reinstalling all the operating system software released since your initial purchase can be a lengthy process.
- 

### Restoring and recovering your system

You have several tools available to recover your system both within and outside of Windows if the desktop cannot load.

HP recommends that you attempt to restore your system using the [Restoring and recovery methods on page 80](#).

## Creating a system restore

System Restore is available in Windows. The System Restore software can automatically or manually create restore points, or snapshots, of the system files and settings on the computer at a particular point.

When you use System Restore, it returns your computer to its state at the time you made the restore point. Your personal files and documents should not be affected.

## Restoring and recovery methods

After you run the first method, test to see whether the issue still exists before you proceed to the next method, which might now be unnecessary.

1. Run a Microsoft System Restore.
2. Run Reset this PC.

---

 **NOTE:** The options **Remove everything** and then **Fully clean the drive** can take several hours to complete and leave no information on your computer. It is the safest way to reset your computer before you recycle it.

---

3. Recover using the HP Recovery USB flash drive. For more information, see [Recovering using the HP Recovery USB flash drive on page 80](#).

For more information about the first two methods, see the Get Help app:

- Select the **Start** button, select **All apps**, select the **Get Help** app, and then enter the task you want to perform.

---

 **NOTE:** You must be connected to the internet to access the Get Help app.

---

## Recovering using the HP Recovery USB flash drive

You can use the HP Recovery USB flash drive to recover the operating system and drivers that were installed at the factory. On select products, you can create recovery media on a bootable USB flash drive using the HP Cloud Recovery Download Tool.

For details, see [Using the HP Cloud Recovery Download Tool to create a recovery USB flash drive \(select products only\) on page 79](#).

---

 **NOTE:** In select countries, if you cannot create the HP Recovery USB flash drive yourself, contact support. Go to <http://www.hp.com/support>, select your country or region, and then follow the on-screen instructions.

---

To recover your system:

- Insert the HP Recovery USB flash drive, and then restart the computer.

---

 **NOTE:** HP recommends that you follow the [Restoring and recovery methods on page 80](#) to restore your computer before you obtain and use the HP USB flash drive. Using a recent backup can return your machine to a working state sooner than using the HP USB flash drive. After the system is restored, reinstalling all the operating system software released since your initial purchase can be a lengthy process.

---

## Changing the computer boot order

If your computer does not restart using the HP Recovery USB flash drive, you can change the computer boot order, which is the order of devices listed in BIOS for startup information.

---

 **IMPORTANT:** For a tablet with a detachable keyboard, connect the tablet to the keyboard base before beginning these steps.

---

To change the boot order:

1. Insert the HP Recovery USB flash drive.
2. Access the system **Startup** menu.
  - For computers or tablets with keyboards attached, turn on or restart the computer or tablet, quickly press **esc**, and then press **f9** for boot options.
  - For tablets without keyboards, turn on or restart the tablet, and then quickly press and hold one of the following buttons:
    - Volume up
    - Volume down

Then select **f9**.
3. Select the USB flash drive to boot from, and then follow the on-screen instructions.

## Using HP Sure Recover (select products only)

Select computer models are configured with HP Sure Recover, a PC operating system (OS) recovery solution built into the hardware and software. HP Sure Recover can fully restore the HP OS image without installed recovery software.

Using HP Sure Recover, an administrator or user can restore the system and install:

- Latest version of the operating system
- Platform-specific device drivers
- Software applications, in the case of a custom image

To access the latest documentation for HP Sure Recover, go to <http://www.hp.com/support>. Follow the on-screen instructions to find your product and locate your documentation.

---

## 9 Using HP PC Hardware Diagnostics

You can use the HP PC Hardware Diagnostics utility to determine whether your computer hardware is running properly. The three versions are HP PC Hardware Diagnostics Windows, HP PC Hardware Diagnostics UEFI (Unified Extensible Firmware Interface), and (for select products only) Remote HP PC Hardware Diagnostics UEFI, a firmware feature.

### Using HP PC Hardware Diagnostics Windows (select products only)

HP PC Hardware Diagnostics Windows is a Windows-based utility that allows you to run diagnostic tests to determine whether the computer hardware is functioning properly. The tool runs within the Windows operating system to diagnose hardware failures.

If HP PC Hardware Diagnostics Windows is not installed on your computer, you must download and install it. To download HP PC Hardware Diagnostics Windows, see [Downloading HP PC Hardware Diagnostics Windows on page 83](#).

### Using an HP PC Hardware Diagnostics Windows hardware failure ID code

When HP PC Hardware Diagnostics Windows detects a failure that requires hardware replacement, a 24-digit failure ID code is generated for select component tests. For interactive tests, such as keyboard, mouse, or audio and video palette, you must perform troubleshooting steps before you can receive a failure ID.

You have several options after you receive a failure ID:

- Select **Next** to open the Event Automation Service (EAS) page, where you can log the case.
- Scan the QR code with your mobile device, which takes you to the EAS page, where you can log the case.
- Select the box next to the 24-digit failure ID to copy your failure code and send it to support.

### Accessing HP PC Hardware Diagnostics Windows

After HP PC Hardware Diagnostics Windows is installed, you can access it from HP Support Assistant or the Start menu.

#### Accessing HP PC Hardware Diagnostics Windows from HP Support Assistant

After HP PC Hardware Diagnostics Windows is installed, follow these steps to access it from HP Support Assistant:

1. Complete one of the following tasks:
  - Select the **Search** icon in the taskbar, type `support` in the search box, and then select the **HP Support Assistant** app.
  - Select the question mark icon in the taskbar.
2. Select **Fixes & Diagnostics**.

3. Select **Run hardware diagnostics**, and then select **Launch**.
4. When the tool opens, select the type of diagnostic test that you want to run, and then follow the on-screen instructions.

---

 **NOTE:** To stop a diagnostic test, select **Cancel**.

---

## Accessing HP PC Hardware Diagnostics Windows from the Start menu (select products only)

After HP PC Hardware Diagnostics Windows is installed, follow these steps to access it from the Start menu:

1. Select the **Start** button, and then select **All apps**.
2. Select **HP PC Hardware Diagnostics Windows**.
3. When the tool opens, select the type of diagnostic test that you want to run, and then follow the on-screen instructions.

---

 **NOTE:** To stop a diagnostic test, select **Cancel**.

---

## Downloading HP PC Hardware Diagnostics Windows

The HP PC Hardware Diagnostics Windows downloading instructions are provided in English only. You must use a Windows computer to download this tool because only .exe files are provided.

### Downloading the latest HP PC Hardware Diagnostics Windows version from HP

To download HP PC Hardware Diagnostics Windows from HP, follow these steps:

1. Go to <http://www.hp.com/go/techcenter/pcdiags>. The HP PC Diagnostics home page is displayed.
2. Select **Diagnose PC Hardware issues in Windows**, scroll down to the expanded window that appears, and then select **Download**.
3. A pop-up that asks what you want to do with the file opens. Select **Open** or **Save As**. The latest version of the diagnostics tool opens or downloads to the selected location.

### Downloading the HP PC Hardware Diagnostics Windows from the Microsoft Store

You can download the HP PC Hardware Diagnostics Windows from the Microsoft Store:

1. Select the Microsoft Store app on your desktop or select the **Search** icon in the taskbar, and then type `Microsoft Store` in the search box.
2. Type `HP PC Hardware Diagnostics Windows` in the **Microsoft Store** search box.
3. Follow the on-screen directions.

The tool downloads to the selected location.

## Downloading HP Hardware Diagnostics Windows by product name or number (select products only)

You can download HP PC Hardware Diagnostics Windows by product name or number.

---

 **NOTE:** For some products, you might have to download the software to a USB flash drive by using the product name or number.

---

1. Go to <http://www.hp.com/support>.
2. Select **Software and Drivers**, select your type of product, and then enter the product name or number in the search box that is displayed.
3. In the **Diagnostics** section, select **Download**, and then follow the on-screen instructions to select the specific Windows diagnostics version to be downloaded to your computer or USB flash drive.

The tool downloads to the selected location.

## Installing HP PC Hardware Diagnostics Windows

To install HP PC Hardware Diagnostics Windows, navigate to the folder on your computer or the USB flash drive where the .exe file downloaded, double-click the .exe file, and then follow the on-screen instructions.

## Using HP PC Hardware Diagnostics UEFI

HP PC Hardware Diagnostics Unified Extensible Firmware Interface (UEFI) allows you to run diagnostic tests to determine whether the computer hardware is functioning properly. The tool runs outside the operating system so that it can isolate hardware failures from issues that are caused by the operating system or other software components.

---

 **NOTE:** For some products, you must use a Windows computer and a USB flash drive to download and create the HP UEFI support environment because only .exe files are provided. For more information, see [Downloading HP PC Hardware Diagnostics UEFI to a USB flash drive on page 85](#).

---

If your PC does not start in Windows, you can use HP PC Hardware Diagnostics UEFI to diagnose hardware issues.

## Using an HP PC Hardware Diagnostics UEFI hardware failure ID code

When HP PC Hardware Diagnostics UEFI detects a failure that requires hardware replacement, a 24-digit failure ID code is generated.

For assistance in solving the problem, complete one of these tasks:

- Select **Contact HP**, accept the HP privacy disclaimer, and then use a mobile device to scan the failure ID code that appears on the next screen. The HP Customer Support - Service Center page appears with your failure ID and product number automatically filled in. Follow the on-screen instructions.
- Contact support, and provide the failure ID code.

## Starting HP PC Hardware Diagnostics UEFI

To start HP PC Hardware Diagnostics UEFI, follow this procedure.

1. Turn on or restart the computer, and quickly press [esc](#).
2. Press [f2](#).

The BIOS searches three places for the diagnostic tools, in the following order:

- a. Connected USB flash drive

---

 **NOTE:** To download the HP PC Hardware Diagnostics UEFI tool to a USB flash drive, see [Downloading the latest HP PC Hardware Diagnostics UEFI version on page 86](#).

---

- b. Hard drive
- c. BIOS

3. When the diagnostic tool opens, select the type of diagnostic test that you want to run, and then follow the on-screen instructions.

## Starting HP PC Hardware Diagnostics UEFI through HP Hotkey Support software (select products only)

This section describes how to start HP PC Hardware Diagnostics UEFI through HP Hotkey Support software.

---

 **NOTE:** You must disable fast boot to access HP PC Hardware Diagnostics UEFI from the HP System Information application.

To disable fast boot:

1. Turn on or restart the computer, and when the HP logo appears, press [f10](#) to enter Computer Setup.
2. Select **Advanced**, and then select **Boot Options**.
3. Clear **Fast Boot**.
4. Select **Save Changes and Exit**, and then select **Yes**.

---

To start HP PC Hardware Diagnostics UEFI through HP Hotkey Support software, follow this procedure:

1. From the **Start** menu, open the HP System Information Application or press [fn+esc](#).
2. In HP System Information screen, select **Run System Diagnostics**, select **Yes** to run the application, and then select **Restart**.

---

 **IMPORTANT:** To prevent loss of data, save your work in all open apps before restarting your computer.

 **NOTE:** When the restart is complete, the computer opens the HP PC Hardware Diagnostics UEFI Application. Proceed with the troubleshooting tests.

---

## Downloading HP PC Hardware Diagnostics UEFI to a USB flash drive

Downloading HP PC Hardware Diagnostics UEFI to a USB flash drive can be useful in some situations.

- HP PC Hardware Diagnostics UEFI is not included in the preinstallation image.
- HP PC Hardware Diagnostics UEFI is not included in the HP Tool partition.

- The hard drive is damaged.

---

 **NOTE:** The HP PC Hardware Diagnostics UEFI downloading instructions are provided in English only, and you must use a Windows computer to download and create the HP UEFI support environment because only .exe files are provided.

---

## Downloading the latest HP PC Hardware Diagnostics UEFI version

To download the latest HP PC Hardware Diagnostics UEFI version to a USB flash drive, follow these steps:

1. Go to <http://www.hp.com/go/techcenter/pcdiags>. The HP PC Diagnostics home page is displayed.
2. Select **Diagnose PC Hardware Issues outside of the OS**, scroll down to the expanded window that appears, and then select **Download**.
3. A pop-up that asks what you want to do with the file opens. Select **Open** or **Save As**. The latest version of the diagnostics tool opens or downloads to the selected location.

## Downloading HP PC Hardware Diagnostics UEFI by product name or number (select products only)

You can download HP PC Hardware Diagnostics UEFI by product name or number (select products only) to a USB flash drive.

---

 **NOTE:** For some products, you might have to download the software to a USB flash drive by using the product name or number.

---

1. Go to <http://www.hp.com/support>.
2. Enter the product name or number, select your computer, and then select your operating system.
3. In the **Diagnostics** section, follow the on-screen instructions to select and download the specific UEFI Diagnostics version for your computer.

## Using Remote HP PC Hardware Diagnostics UEFI settings (select products only)

Remote HP PC Hardware Diagnostics UEFI is a firmware (BIOS) feature that downloads HP PC Hardware Diagnostics UEFI to your computer. It can then run the diagnostics on your computer, and it might upload results to a preconfigured server.

For more information about Remote HP PC Hardware Diagnostics UEFI, go to <http://www.hp.com/go/techcenter/pcdiags>, select **Diagnose Other Potential Issues**, scroll down to **Remote PC Hardware Diagnostics UEFI**, and then select **Learn More**.

## Downloading Remote HP PC Hardware Diagnostics UEFI

Remote HP PC Hardware Diagnostics UEFI is also available as a SoftPaq that you can download to a server.

## Downloading the latest Remote HP PC Hardware Diagnostics UEFI version

You can download the latest Remote HP PC Hardware Diagnostics UEFI version to a USB flash drive.

1. Go to <http://www.hp.com/go/techcenter/pcdiags>. The HP PC Diagnostics home page is displayed.

2. Select **Diagnose PC Hardware Issues outside of the OS**, scroll down to the expanded window that appears, and then select **Download**.
3. A pop-up that asks what you want to do with the file opens. Select **Open** or **Save As**. The latest version of the diagnostics tool opens or downloads to the selected location.

## Downloading Remote HP PC Hardware Diagnostics UEFI by product name or number

You can download Remote HP PC Hardware Diagnostics UEFI by product name or number.

 **NOTE:** For some products, you might have to download the software by using the product name or number.

1. Go to <http://www.hp.com/support>.
2. Select **Software and Drivers**, select your type of product, enter the product name or number in the search box that is displayed, select your computer, and then select your operating system.
3. In the **Diagnostics** section, follow the on-screen instructions to select and download the **Remote UEFI** version for the product.

## Customizing Remote HP PC Hardware Diagnostics UEFI settings

Using the Remote HP PC Hardware Diagnostics setting in Computer Setup (BIOS), you can perform several customizations.

- Set a schedule for running diagnostics unattended. You can also start diagnostics immediately in interactive mode by selecting **Execute Remote HP PC Hardware Diagnostics UEFI**.
- Set the location for downloading the diagnostic tools. This feature provides access to the tools from the HP website or from a server that has been preconfigured for use. Your computer does not require the traditional local storage, such as a hard drive or USB flash drive, to run remote diagnostics.
- Set a location for storing the test results. You can also set the user name and password that you use for uploads.
- Display status information about the diagnostics run previously.

To customize Remote HP PC Hardware Diagnostics UEFI settings, follow these steps:

1. Turn on or restart the computer, and when the HP logo appears, press **f10** to enter Computer Setup.
2. Select **Advanced**, and then select **Settings**.
3. Make your customization selections.
4. Select **Main**, then select **Save Changes and Exit** to save your settings.

Your changes take effect when the computer restarts.

# 10 Specifications

This chapter provides specifications for your computer system.

## Computer specifications

This section provides specifications for your computer. When you travel with your computer, the computer dimensions and weights, as well as input power ratings and operating specifications, provide helpful information.

**Table 10-1** Computer specifications

	Metric	U.S.
<b>Dimensions</b>		
Width	313.0 mm	12.32 in
Depth	218.5 mm	8.6 in
Height (front)	11.35 mm	0.45 in
Height (rear)	14.65 mm	0.58 in
Max height	16.95 mm	0.67 in
<b>Weight</b>		
OLED display	1410.0 g	3.11 lb
LED display	1550.0 g	3.42 lb
<b>Input power</b>		
Operating voltage and current	5 V DC @ 3 A / 9 V DC @ 3 A / 12 V DC @ 5 A / 15 V DC @ 4.33 A / 20 V DC @ 3.25 A - 65 W USB-C	
	5 V DC @ 3 A / 9 V DC @ 3 A / 10 V DC @ 5 A / 12 V DC @ 5 A / 15 V DC @ 4.33 A / 20 V DC @ 3.25 A - 65 W USB-C	
<b>Temperature</b>		
Operating	5°C to 35°C	41°F to 95°F
Nonoperating	-20°C to 60°C	-4°F to 140°F
<b>Relative humidity</b> (noncondensing)		
Operating	10% to 90%	
Nonoperating	5% to 95%	
<b>Maximum altitude</b> (unpressurized)		
Operating	-15 m to 3,048 m	-50 ft to 10,000 ft

**Table 10-1 Computer specifications (continued)**

	Metric	U.S.
Nonoperating	-15 m to 12,192 m	-50 ft to 40,000 ft

 **NOTE:** Applicable product safety standards specify thermal limits for plastic surfaces. The device operates well within this range of temperatures.

## Display specifications

This section provides specifications for your display.

**Table 10-2 Display specifications**

	Metric	U.S.
Active diagonal size	35.6 cm	14.0 in
Resolution	2880 × 1800 (2.8K) 1920 × 1200 (WUXGA)	
Surface treatment	BrightView	
Brightness	400 nits	
Viewing angle	UWVA	
Backlight	OLED (2.8K) LED (WUXGA)	
Display panel interface	eDP	

## Solid-state drive specifications

This section provides specifications for your solid-state drives.

**Table 10-3 Solid-state drive specifications**

	512 GB*	1 TB*	2 TB*
<b>Dimensions</b>			
Height	1.0 mm	1.0 mm	1.0 mm
Length	50.8 mm	50.8 mm	50.8 mm
Width	28.9 mm	28.9 mm	28.9 mm
Weight	< 10 g	< 10 g	< 10 g
<b>Interface type</b>			
Ready time, maximum (to not busy)	< 1.0 ms	< 1.0 ms	< 1.0 ms
Access times, logical	0.1 ms	0.1 ms	0.1 ms
<b>Transfer rate</b>			
Sequential read	up to 2150 MBps	Up to 300,000 IOPs	Up to 300,000 IOPs

**Table 10-3 Solid-state drive specifications (continued)**

	<b>512 GB*</b>	<b>1 TB*</b>	<b>2 TB*</b>
Random read	Up to 300,000 IOPs	Up to 300,000 IOPs	Up to 300,000 IOPs
Sequential write	up to 1550 MBps	up to 1550 MBps	up to 2500 MBps
Random write	Up to 100,000 IOPs	Up to 100,000 IOPs	Up to 125,000 IOPs
<b>Total logical sectors</b>	1,000,215,216	1,500,336,388	2,985,523,121
<b>Operating temperature</b>	<b>0°C to 70°C</b> (32°F to 158°F)	<b>0°C to 70°C</b> (32°F to 158°F)	<b>0°C to 70°C</b> (32°F to 158°F)

\*1 GB = 1 billion bytes when referring to hard drive storage capacity. Actual accessible capacity is less. Actual drive specifications might differ slightly.



**NOTE:** Certain restrictions and exclusions apply. Contact support for details.

# 11 Power cord set requirements

This chapter provides power cord requirements for countries and regions.

The wide-range input feature of the computer permits it to operate from any line voltage from 100 V AC to 120 V AC, or from 220 V AC to 240 V AC.

The three-conductor power cord set included with the computer meets the requirements for use in the country or region where the equipment is purchased.

Power cord sets for use in other countries or regions must meet the requirements of the country and region where the computer is used.

## Requirements for all countries

These power cord requirements are applicable to all countries and regions.

- The length of the power cord set must be at least **1.0 m** (3.3 ft) and no more than **2.0 m** (6.5 ft).
- All power cord sets must be approved by an acceptable accredited agency responsible for evaluation in the country or region where the power cord set will be used.
- The power cord sets must have a minimum current capacity of 10 A and a nominal voltage rating of 125 V AC or 250 V AC, as required by the power system of each country or region.
- The appliance coupler must meet the mechanical configuration of an EN 60 320/IEC 320 Standard Sheet C13 connector for mating with the appliance inlet on the back of the computer.

## Requirements for specific countries and regions

To determine power cord requirements for specific countries and regions, use this table.

**Table 11-1** Power cord requirements for specific countries and regions

Country/region	Accredited agency	Applicable note number
Argentina	IRAM	1
Australia	SAA	1
Austria	OVE	1
Belgium	CEBEC	1
Brazil	ABNT	1
Canada	CSA	2
Chile	IMQ	1
Denmark	DEMKO	1
Finland	FIMKO	1
France	UTE	1

**Table 11-1 Power cord requirements for specific countries and regions (continued)**

Country/region	Accredited agency	Applicable note number
Germany	VDE	1
India	BIS	1
Israel	SII	1
Italy	IMQ	1
Japan	JIS	3
Netherlands	KEMA	1
New Zealand	SANZ	1
Norway	NEMKO	1
The People's Republic of China	CCC	4
Saudi Arabia	SASO	7
Singapore	PSB	1
South Africa	SABS	1
South Korea	KTL	5
Sweden	SEMKO	1
Switzerland	SEV	1
Taiwan	BSMI	6
Thailand	TISI	1
United Kingdom	ASTA	1
United States	UL	2

1. The flexible cord must be Type HO5VV-F, three-conductor, 0.75 mm<sup>2</sup> conductor size. Power cord set fittings (appliance coupler and wall plug) must bear the certification mark of the agency responsible for evaluation in the country or region where it will be used.
2. The flexible cord must be Type SVT/SJT or equivalent, No. 18 AWG, three-conductor. The wall plug must be a two-pole grounding type with a NEMA 5-15P (15 A, 125 V AC) or NEMA 6-15P (15 A, 250 V AC) configuration. CSA or C-UL mark. UL file number must be on each element.
3. The appliance coupler, flexible cord, and wall plug must bear a T mark and registration number in accordance with the Japanese Dentori Law. The flexible cord must be Type VCTF, three-conductor, 0.75 mm<sup>2</sup> or 1.25 mm<sup>2</sup> conductor size. The wall plug must be a two-pole grounding type with a Japanese Industrial Standard C8303 (7 A, 125 V AC) configuration.
4. The flexible cord must be Type RVV, three-conductor, 0.75 mm<sup>2</sup> conductor size. Power cord set fittings (appliance coupler and wall plug) must bear the CCC certification mark.
5. The flexible cord must be Type HO5VV-F three-conductor, 0.75 mm<sup>2</sup> conductor size. KTL logo and individual approval number must be on each element. Approval number and logo must be printed on a flag label.
6. The flexible cord must be Type HVCTF three-conductor, 1.25 mm<sup>2</sup> conductor size. Power cord set fittings (appliance coupler, cable, and wall plug) must bear the BSMI certification mark.

7. For 127 V AC, the flexible cord must be Type SVT or SJT 3-conductor, 18 AWG, with plug NEMA 5-15P (15 A, 125 V AC), with UL and CSA or C-UL marks. For 240 V AC, the flexible cord must be Type H05VV-F three-conductor, 0.75 mm<sup>2</sup> or 1.00 mm<sup>2</sup> conductor size, with plug BS 1363/A with BSI or ASTA marks.

---

## 12 Swelling or deformation of notebook battery

To protect your hardware from potential damage, HP recommends that if you are experiencing battery swelling, stop using the notebook until you can replace the battery.

You can contact HP to understand what battery replacement options are available. To learn more about Lithium-ion batteries and the factors that can accelerate battery swelling, see [https://support.hp.com/us-en/document/ish\\_6824662-6824706-16](https://support.hp.com/us-en/document/ish_6824662-6824706-16).

### Swollen notebook batteries

You might notice that your notebook battery has become somewhat deformed or swollen over time. In some cases, the battery swelling might be significant enough to impact other components of the system including the touchpad, keyboard, and chassis.

### Swollen battery is not a safety issue

A swollen battery does not present a safety issue. It is the result of the generation of gases per the normal degradation of the battery cell over time.

HP has worked closely with our battery cell suppliers and third-party industry experts to help minimize the potential for HP batteries to swell over time and to identify that swollen batteries are not a safety issue.

### Discontinue using a swollen battery

To protect your hardware from potential damage, HP recommends that, if you are experiencing battery swelling, you stop using the notebook until the battery can be replaced.

You can contact <https://www.hp.com/go/contacthp> to understand what battery replacement options are available.

### Replace a swollen battery

If a battery is under warranty, HP will replace the battery per the terms and conditions of the HP Worldwide Limited Warranty or applicable HP Care Packs.

For batteries no longer under warranty, contact HP to purchase a genuine HP replacement battery.

### Minimize battery swelling

Multiple factors can accelerate battery swelling.

To help mitigate battery swelling over time, you can use either HP Adaptive Battery Optimizer (consumer notebooks) or HP Battery Health Manager (commercial notebooks) settings to improve battery longevity and performance for various use scenarios.

## HP Adaptive Battery Optimizer (consumer notebooks)

HP Adaptive Battery Optimizer technology can help mitigate the factors that cause the battery to swell. It is available on select HP OMEN, HP Spectre, HP Pavilion, and HP ENVY notebook computers.

HP Adaptive Battery Optimizer has been available on select gaming notebooks since 2019 and select consumer notebooks since 2020. To learn more about enabling HP Adaptive Battery Optimizer on your HP notebook, see <https://support.hp.com/us-en/document/c06310986>.

## HP Battery Health Manager (commercial notebooks)

HP Battery Health Manager provides an easy-to-manage solution to help mitigate factors that cause the battery to swell. It is available on select HP ProBook and HP EliteBook notebook computers.

HP Battery Health Manager is available on select commercial notebooks manufactured since 2016. To learn more about HP Battery Health Manager, see [https://support.hp.com/us-en/document/ish\\_4449597-3519507-16](https://support.hp.com/us-en/document/ish_4449597-3519507-16).

---

# 13 Recycling

When a nonrechargeable or rechargeable battery has reached the end of its useful life, do not dispose of the battery in general household waste. Follow the local laws and regulations in your area for battery disposal.

HP encourages customers to recycle used electronic hardware, HP original print cartridges, and rechargeable batteries. For more information about recycling programs, see the HP website at <http://www.hp.com/recycle>.

# Index

## Symbols/Numerics

360 modes, identifying 14

## A

AC adapter and battery light, identifying 6  
AC adapters, spare part numbers 19  
action key, identifying 12  
audio-out (headphone)/audio-in (microphone) combo jack, identifying 5  
audio, product description 2

## B

backup, creating 79  
backups 79  
battery  
    illustrated 17  
    spare part number 17  
battery swelling 94  
BIOS  
    determining version 76  
    downloading an update 77, 78  
    starting the Setup Utility 76  
    updating 76  
Bluetooth label 14  
boot order, changing 81  
bottom components 13  
bottom cover  
    illustrated 17  
    removal 30  
    spare part number 17, 30  
buttons  
    left touchpad 9, 10  
    power 13  
    right touchpad 9, 10

## C

camera  
    identifying 8  
    illustrated 19  
    spare part number 19  
camera light, identifying 8  
camera privacy cover, identifying 8  
caps lock light 11

caring for your computer 25  
cautions  
    electrostatic discharge 21, 22  
cleaning your computer 25  
    caring for wood veneer 27  
    disinfecting 26  
    HP Easy Clean 25  
    removing dirt and debris 25  
components  
    bottom 13  
    display 7  
    keyboard area 9  
    left side 6  
    lights 10  
    rear 13  
    right side 5  
    touchpad 9  
computer major components 16  
computer specifications 88  
connectors  
    power 6, 7  
control zone 9

## D

display  
    specifications 88, 89  
display assembly  
    subcomponents 18  
display back cover  
    illustrated 19  
    spare part number 19  
display cable  
    illustrated 19  
    spare part number 19  
display components 7  
display panel  
    illustrated 18  
    product description 1  
    spare part number 18

## E

electrostatic discharge (ESD) 21, 22  
    preventing damage 21-23  
esc key, identifying 12

## F

fan  
    illustrated 17  
    removal 47  
    spare part number 17, 47  
fn key, identifying 12  
fn lock light, identifying 11

## G

graphics, product description 1  
grounding methods 21-23  
guidelines  
    packaging 21, 27  
    transporting 21, 27  
    workstation 21

## H

hard drive  
    product description 2  
    specifications 88  
HDMI port  
    identifying 6  
heat sink  
    illustrated 17  
    removal 50  
    spare part number 17  
    spare part numbers 50  
hinge  
    illustrated 19  
    spare part number 19  
HP PC Hardware Diagnostics UEFI  
    downloading 85  
    failure ID code 84  
    HP Hotkey Support software 85  
    starting 84, 85  
    using 84  
HP PC Hardware Diagnostics Windows  
    accessing 82, 83  
    downloading 83  
    failure ID code 82  
    installing 84  
    using 82  
HP Recovery media recovery 80  
HP Sure Recover 81

## I

- I/O board
  - removal 46
  - spare part number 46
- illustrated parts catalog 16
- internal microphones, identifying 8
- IR sensor board
  - illustrated 17
  - removal 56
  - spare part number 17, 56

## J

- jacks
  - audio-out (headphone)/audio-in (microphone) 5

## K

- keyboard
  - product description 3
- keyboard country codes 73
- keys
  - action 12
  - esc 12
  - fn 12
  - Windows 12
  - Windows Copilot 12

## L

- labels
  - Bluetooth 14
  - regulatory 14
  - serial number 14
  - service 14
  - wireless certification 14
  - WLAN 14
- left control zone, identifying 9
- left side components 6
- lights
  - AC adapter and battery 6
  - camera 8
  - caps lock 11
  - fn lock 11
  - microphone mute 11
  - mute 11
  - power 11
  - touchpad 9
- low blue light mode 7

## M

- magnetic pen attachment area, identifying 5

- memory module
  - product description 2
- microphone
  - product description 2
- microphone mute light, identifying 11
- model name 1
- mute light, identifying 11

## O

- OLED board
  - illustrated 19
  - spare part number 19
- operating system, product description 4

## P

- packaging guidelines 21, 27
- pointing device, product description 3
- ports
  - HDMI 6
  - product description 3
  - USB 5, 6
  - USB Type-C power connector and port with HP Sleep and Charge and DisplayPort output 6, 7
- power connector
  - identifying 6, 7
- power cord
  - requirements for all countries 91
  - requirements for specific countries and regions 91
  - set requirements 91
- power cords, spare part numbers 19
- power key, identifying 13
- power light, identifying 11
- power requirements, product description 3
- primary storage
  - product description 2
- processor
  - product description 1
- product description
  - audio 2
  - display panel 1
  - graphics 1
  - hard drive 2
  - keyboard 3
  - memory module 2
  - microphone 2

- operating system 4
- pointing device 3
- ports 3
- power requirements 3
- primary storage 2
- processors 1
- product name 1
- security 3
- serviceability 4
- solid-state drive 2
- video 2
- wireless 2
- product name 1
- product name and number, computer 14

## R

- rear components 13
- recovery 79
  - discs 80
  - media 80
  - USB flash drive 80
- recovery media 79
  - creating using HP Cloud Recovery Download Tool 79
  - creating using Windows tools 79
- regulatory information
  - regulatory label 14
  - wireless certification labels 14
- Remote HP PC Hardware Diagnostics UEFI settings
  - customizing 87
  - using 86
- removal and replacement procedures 30, 40
  - solid-state drive 40
- restoring 79
- restoring and recovery methods 80
- right control zone, identifying 9
- right side components 5

## S

- Screw Kit, spare part number 19
- security, product description 3
- serial number, computer 14
- service labels, locating 14
- serviceability, product description 4
- solid-state drive
  - illustrated 17
  - product description 2

- removal and replacement 40
- spare part number 17
- specifications 89
- speaker
  - illustrated 17
  - removal 42
  - spare part number 17
  - spare part numbers 42
- speakers 14
- special keys
  - identifying 11
  - using 11
- specifications
  - computer 88
  - display 88, 89
  - hard drive 88
  - solid-state drive 89
- static electricity 21, 22
- support information 27
- swelling or deformation of
  - notebook battery 94
- system board
  - illustrated 17
  - removal 51
  - spare part number 17
  - spare part numbers 51
- system restore 80
- system restore point, creating 79

**T**

- top cover
  - illustrated 17
- top cover with keyboard
  - spare part number 17
  - spare part numbers 73
- touch control board
  - illustrated 19
  - spare part number 19
- touchpad
  - illustrated 17
  - removal 45
  - settings 9
  - spare part number 17
  - spare part numbers 45
- touchpad buttons
  - identifying 9, 10
- touchpad components 9
- touchpad light, identifying 9
- touchpad settings, adjusting 9
- touchpad zone, identifying 9, 10
- transporting guidelines 21, 27
- traveling with the computer 14

**U**

- USB board
  - illustrated 17
  - spare part number 17
- USB port, identifying 5, 6
- USB Type-C power connector and port with HP Sleep and Charge and DisplayPort output, identifying 6, 7

**V**

- vents, identifying 13, 14
- video, product description 2

**W**

- wake-on-voice 7
- Windows
  - backup 79
  - recovery media 79
  - system restore point 79
- Windows Copilot key, identifying 12
- Windows key, identifying 12
- Windows tools, using 79
- wireless antennas
  - illustrated 19
  - spare part number 19
- wireless antennas, identifying 8
- wireless certification label 14
- wireless, product description 2
- WLAN antennas, identifying 8
- WLAN device 14
- WLAN label 14
- WLAN module
  - removal 43
  - spare part number 43
- workstation guidelines 21