

Hardware Quick Reference

LANCOM 1780EW-4G+

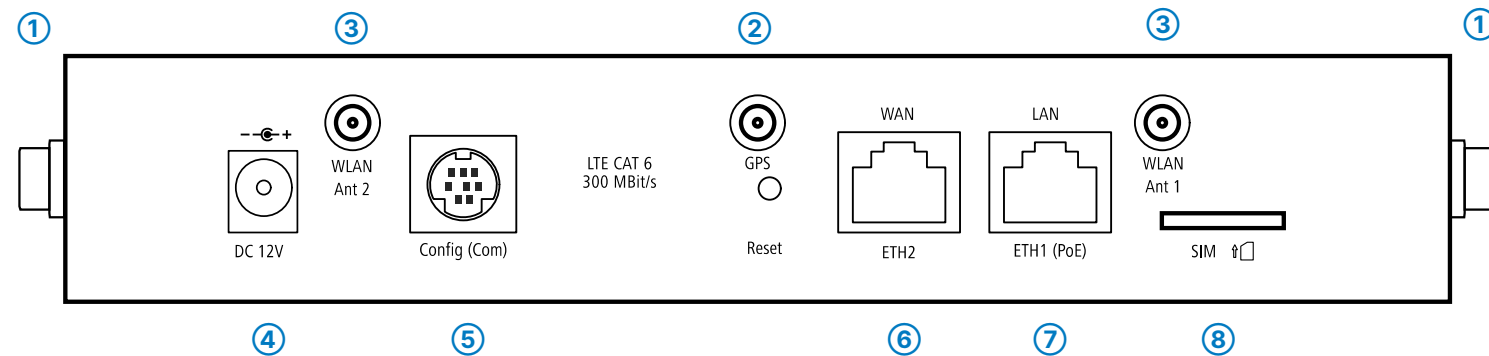

- 1 LTE / 4G antennas**
Connect the two supplied cellular antennas to the connectors located at the device's sides.
- 2 GPS antenna (optional)**
Connect the GPS antenna (free of charge) to the connector GPS (see included voucher).
- 3 WLAN antennas**
Screw the two supplied WLAN antennas onto the connectors WLAN Ant 1 and WLAN Ant 2. The desired MIMO behaviour can be configured under > Physical WLAN Settings > Radio > Antenna grouping
- 4 Power**
When connecting the cable to the device, turn the bayonet connector 90° clockwise until it clicks into place. Use only the supplied power adapter.

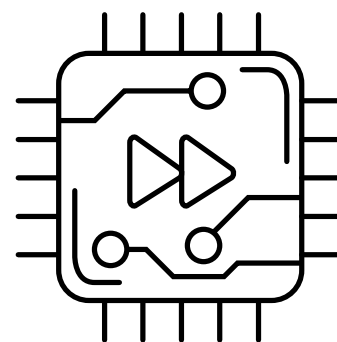
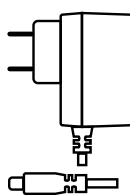
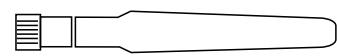
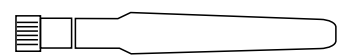

- 5 Serial interface**
Configuring the device via the serial interface requires a serial configuration cable (available as an accessory).
- 6 WAN interface**
Use the cable with the green-colored connectors to connect the interface ETH2 to your WAN modem.
- 7 Ethernet interface**
Use the cable with the kiwi-colored connectors to connect the interface ETH1 (PoE) to your PC or a LAN switch.
- 8 Optional: SIM card**
Slide the SIM card into the slot using the marker to ensure that the card is the right way round. Ensure that the SIM card clicks into place on insertion. To remove the card from the device again, press the card lightly into the device. Let go to release the SIM card from the slot.

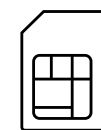
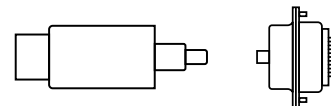

Before initial startup, please make sure to take notice of the information regarding the intended use in the enclosed installation guide!

Operate the device only with a professionally installed power supply at a nearby power socket that is freely accessible at all times.

The SIM card may only be inserted or removed when the device is switched off. Inserting or removing the SIM card when the device is switched on can destroy the 4G module!

Antennas may only be mounted or replaced when the device is switched off. Mounting or removing the antennas when the device is switched on can destroy the 4G or Wi-Fi modules!



Please observe the following when setting up the device

- The power plug of the device must be freely accessible.
- For devices to be operated on the desktop, please attach the adhesive rubber footpads
- Do not rest any objects on top of the device
- Keep all ventilation slots on the side of the device clear of obstruction
- In case of wall mounting, use the drilling template as supplied
- Rack installation with the optional LANCOM Rack Mount (separately available)
- In the case of separately purchased antennas, ensure that the permissible transmission power of the system is not exceeded. The operator of the system is responsible for compliance with the limits.

Mounting & connecting

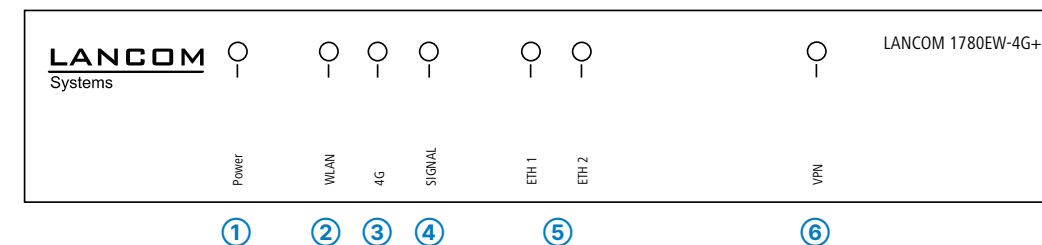

1 Power		3 4G	
Off	Device switched off	Off	Cellular interface disabled
Green, permanently	Device operational, resp. device paired / claimed and LANCOM Management Cloud (LMC) accessible	Green, permanently	Connection to cellular network active
Green / orange, blinking	Configuration password not set. Without a configuration password, the configuration data in the device is unprotected.	Green, flickering	Cellular data transmission
1x green inverse blinking*	Connection to the LMC active, pairing OK, device not claimed	Orange, permanently	Logon to cellular network successful
2x green inverse blinking*	Pairing error, resp. LMC activation code not available	Orange, blinking	Logging on to cellular network
3x green inverse blinking*	LMC not accessible, resp. communication error	Red, permanently	Hardware error/module unavailable
		Red / green, blinking	SIM card error (PIN)
		Red / orange, blinking	Uploading module firmware
2 WLAN		4 SIGNAL	
Off	No Wi-Fi network defined or Wi-Fi module deactivated. The Wi-Fi module is not transmitting beacons.	Off	No cellular reception
Green, permanently	At least one Wi-Fi network is defined and Wi-Fi module activated. The Wi-Fi module is transmitting beacons.	Green, permanently	Good signal strength, greater than or equal to -70 dB
Green, inverse flashing	Number of flashes = number of connected Wi-Fi stations and P2P wireless connections, followed by a pause (default). Alternatively the frequency of the flashing can indicate signal strength over the defined P2P link or the signal strength between the access point and the device operating in client mode.	Orange, permanently	Medium signal strength, field strength between -86 dB and -71 dB
Green, blinking	DFS scanning or other scan procedure	Orange, blinking	Low signal strength, field strength less than -87 dB
Red, blinking	Hardware error in Wi-Fi module	5 ETH	
		Off	No networking device attached
		Green, permanently	Connection to network device operational, no data traffic
		Green, flickering	Data transmission
		6 VPN	
		Off	VPN connection inactive
		Green, permanently	VPN connection active
		Green, blinking	Establishing VPN connections

*1) The additional power LED statuses are displayed in 5-seconds rotation if the device is configured to be managed by the LANCOM Management Cloud.

This product contains separate open-source software components which are subject to their own licenses, in particular the General Public License (GPL). The license information for the device firmware (LCOS) is available on the device's WEBConfig interface under "Extras > License information". If the respective license demands, the source files for the corresponding software components will be made available on a download server upon request.

Hereby, LANCOM Systems GmbH | Adenauerstrasse 20/B2 | D-52146 Wuersele, declares that this device is in compliance with Directives 2014/30/EU, 2014/53/EU, 2014/35/EU, 2011/65/EU, and Regulation (EC) No. 1907/2006. The full text of the EU Declaration of Conformity is available at the following internet address: www.lancom-systems.com/doc

**1) Please respect the restrictions which apply in your country when setting up an antenna system (in particular the antenna gain and transmission power). For information about calculating the correct antenna setup, please refer to www.lancom-systems.com.

Hardware	
Power supply	12 V DC, external power adapter 230 V with bayonet connector to secure against disconnection
Power consumption	Approx. 13 W via external power adapter (value refers to the overall power for the router and power adapter); about 14 W via PoE (IEEE 802.3at)
Environment	Temperature range 0–35 °C; humidity 0–95 %, non-condensing. Temperature range 0–40 °C when mounted vertically on a LANCOM wall mount with cables running to the side.
Housing	Robust synthetic housing, rear connectors, ready for wall mounting, Kensington lock; measures 210 × 45 × 140 mm (W x H x D)
Number of fans	None; fanless design, no rotating parts, high MTBF

Interfaces	
WAN, LAN	10 / 100 / 1000 Base-TX, autosensing, auto node hub
Serial Interface	Serial configuration interface / COM port (8-pin Mini-DIN): 9,600–115,000 baud, suitable for optional connection of analog/GPRS modems. Supports internal COM-port server and provides transparent asynchronous serial-data transfer via TCP.
WLAN: Ant 1, Ant 2	Two reverse SMA connectors for external LANCOM AirLancer antennas or for antennas from other vendors**
4G: Ant 1, Ant 2	Two SMA connectors for the supplied dipole rod antennas (LTE, UMTS), compatible LANCOM AirLancer Extender antennas for 4G or 3G, or from other manufacturers**
GPS	SMA jack for connecting an optionally available GPS antenna

WAN protocols	
Ethernet	PPPoE, Multi-PPPoE, ML-PPP, GRE, EoGRE, PPTP (PAC or PNS), L2TPv2 (LAC or LNS) and IPoE (with or without DHCP), RIP-1, RIP-2, VLAN, IPv6 over PPP (IPv6 and IPv4 / IPv6 Dual Stack Session), IP(v6)oE (Autoconfiguration, DHCPv6 or static)

Data transmission in cellular networks	
Supported standards	UMTS, HSxPA, HSPA+, LTE, LTE Advanced
Supported cellular network bands	Band 1 (2100 MHz), band 2 (1900 MHz), band 3 (1800 MHz), band 4 (2100 MHz), band 5 (800 MHz), band 7 (2600 MHz), band 8 (900 MHz), band 12 (700 MHz), band 13 (700 MHz), band 20 (800 MHz), band 25 (1900 MHz), band 26 (800 MHz), band 29 (700 MHz), band 30 (2300 MHz), band 41 (2500 MHz)
Max. transmission power	+23 dBm
GPS	Positioning with the additional GPS antenna (optional)

Package content	
Cables	2 Ethernet cables, 3 m (LAN: kiwi-colored connectors; WAN: green connectors)
Antennas	Two 3dBi dipole dualband antennas; two LTE / 4G antennas for LTE / UMTS
Power adapter	External power supply adapter 230 V, 12 V / 1.5 A DC/S, barrel connector 2.1 / 5.5 mm bayonet, LANCOM item no. 111301 (EU, 230 V), LANCOM item no. 111302 (UK, 230 V)