



18V LITHIUM ION

# CORDLESS 2-IN-1 NAIL & STAPLE GUN

## INSTRUCTION MANUAL

### SPECIFICATIONS

Input:	18V
Firing Rate:	20/min
Max. Capacity:	90 x Narrow Crown Staples 90 x C1 Brad Nails
Staple Size:	18gauge 16-22mm
Nail Size:	18gauge 15-32mm
Weight:	2.0kg

[ozito.com.au](http://ozito.com.au)

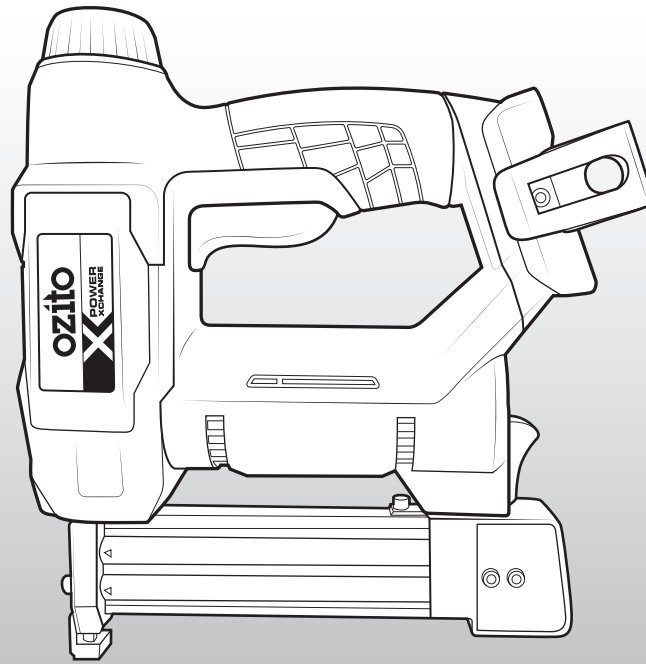

### STANDARD EQUIPMENT

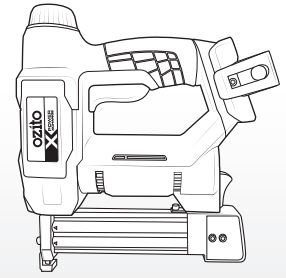

Cordless Staple/Nail Gun

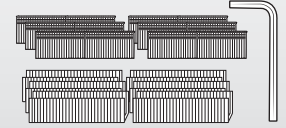

250 x 18 Gauge 32mm C1 Series Brad Nails, 300 x 18 Gauge 16mm Narrow Crown Staples & Hex Key

**5 YEAR**  
REPLACEMENT WARRANTY

**PXNGS-018**

## WARRANTY

IN ORDER TO MAKE A CLAIM UNDER THIS WARRANTY YOU MUST RETURN THE PRODUCT TO YOUR NEAREST BUNNINGS WAREHOUSE WITH YOUR BUNNINGS REGISTER RECEIPT. PRIOR TO RETURNING YOUR PRODUCT FOR WARRANTY PLEASE TELEPHONE OUR CUSTOMER SERVICE HELPLINE:

**Australia 1800 069 486**  
**New Zealand 0508 069 486**

TO ENSURE A SPEEDY RESPONSE PLEASE HAVE THE MODEL NUMBER AND DATE OF PURCHASE AVAILABLE. A CUSTOMER SERVICE REPRESENTATIVE WILL TAKE YOUR CALL AND ANSWER ANY QUESTIONS YOU MAY HAVE RELATING TO THE WARRANTY POLICY OR PROCEDURE.

### WARNING

The following actions will result in the warranty being void.

- If the tool has been operated on a supply voltage other than that specified on the tool.
- If the tool shows signs of damage or defects caused by or resulting from abuse, accidents or alterations.
- Failure to perform maintenance as set out within the instruction manual.
- If the tool is disassembled or tampered with in any way.

The benefits provided under this warranty are in addition to other rights and remedies which are available to you at law.

Our goods come with guarantees that cannot be excluded at law. You are entitled to a replacement or refund for a major failure and for compensation for any other reasonably foreseeable loss or damage. You are also entitled to have the goods repaired or replaced if the goods fail to be of acceptable quality and the failure does not amount to a major failure.

Generally you will be responsible for all costs associated with a claim under this warranty, however, where you have suffered any additional direct loss as a result of a defective product you may be able to claim such expenses by contacting our customer service helpline above.

### 5 YEAR REPLACEMENT WARRANTY

Your Product is guaranteed for a period of 60 months from the original date of purchase and is intended for DIY (Do It Yourself) use only. If a product is defective it will be replaced in accordance with the terms of this warranty. **Lithium Ion batteries and chargers are covered by a 36 month warranty** and are excluded from the warranty extension. Warranty excludes consumable parts.

# KNOW YOUR PRODUCT

## CORDLESS 2-IN-1 NAIL & STAPLE GUN

- |                          |                            |
|--------------------------|----------------------------|
| 1. Force Adjustment Dial | 7. Cartridge               |
| 2. On/Off Trigger        | 8. Safety Striker Guard    |
| 3. Sure Grip Handle      | 9. Nose Piece              |
| 4. Battery Seating       | 10. Status Indicator Light |
| 5. Belt Clip             | 11. Hex Key Storage        |
| 6. Cartridge Latch       |                            |

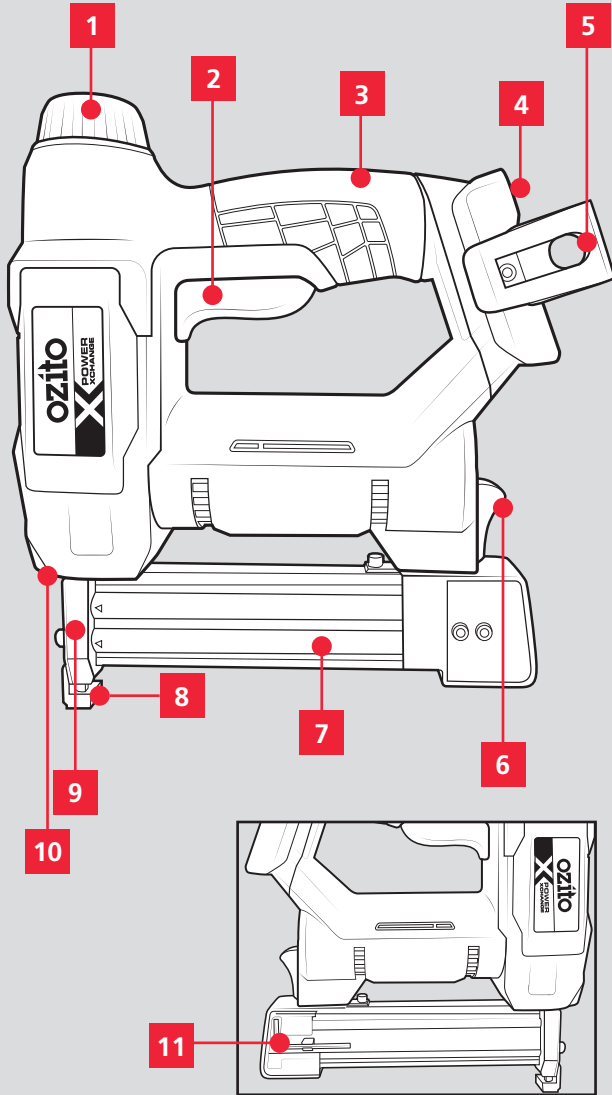

## BATTERY & CHARGER

This tool is compatible with all batteries & chargers from the Ozito Power X Change range.

### ONLINE MANUAL

Scan this QR Code with your mobile device to take you to the online manual.



# SETUP & PREPARATION

## 1. FITTING THE BATTERY

### Installing The Battery Pack

1. Slide the battery into the tool base until it clicks into place.

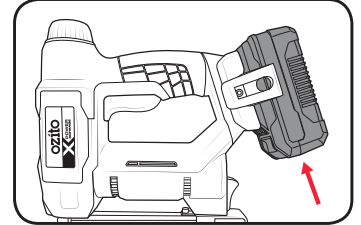

### Removing The Battery Pack

1. Hold down the battery release button and then slide the battery out.

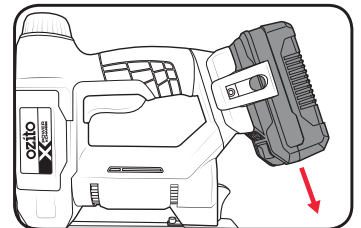
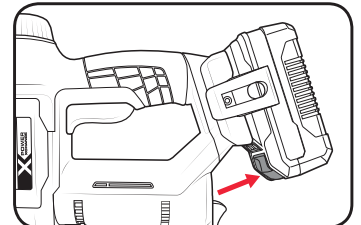

**5 YEAR**  
REPLACEMENT WARRANTY

## 2. NAIL/STAPLE SELECTION

### Fastener Selection

Accessories to suit this Staple Nail Gun can be purchased from Bunnings Warehouse.

Fastener	Common Applications
Staples	Insulation, Upholstery, Weather Stripping, Wall Decorations, Crafts, Covering Cornices, Webbing, Light Fabrics, Carpeting, Wire Mesh, Plastic or Canvas Coverings, Roofing Paper, Felt.
Nails	Trim Moulding, Panelling, Picture Frames, Model Work, Any Finish Nailing Application.

### Staple Measurements

This tool accepts staples with the measurements below:

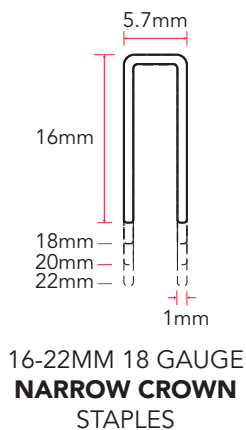

### Nail Measurements

This tool accepts nails with the measurements below:

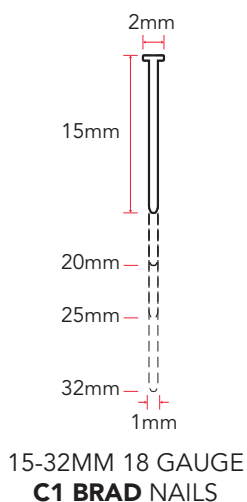

## 3. LOADING THE CARTRIDGE



**WARNING!** ENSURE THE BATTERY IS REMOVED BEFORE PERFORMING ANY OF THE FOLLOWING TASKS.

### Loading Staples

This staple nailer only accepts Narrow Crown 18 gauge 16-22mm staples. Other types of staples, including paper staples, will jam the unit. For best results, load a full row of staples before use.

1. Press the cartridge latch down and pull the magazine slider out of the tool.

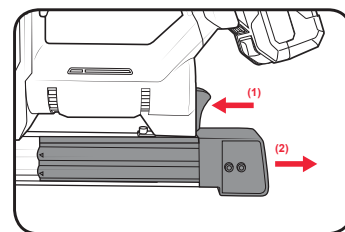

3. Insert a row of staples into the opening behind the nose piece. **Be sure to align them to the upper left corner of the cartridge.**

**Note:** Rows of more than 90 staples do not fit in the staple nail gun.

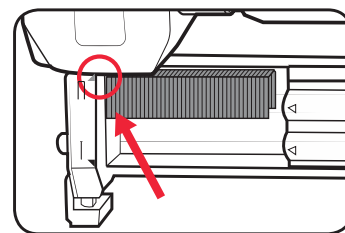

4. Push the magazine slider back into the unit until it clips into place.

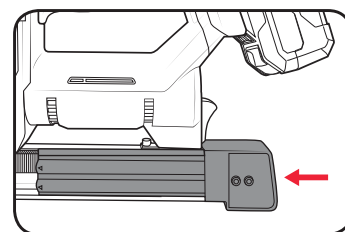

# OPERATION

## Loading Nails

This staple nailer only accepts 15-32mm 18 gauge C1 Brad nails. Other types of nails will jam the unit. For best results, load a full row of nails before use.

1. Press the cartridge latch down and pull the magazine slider out of the tool.

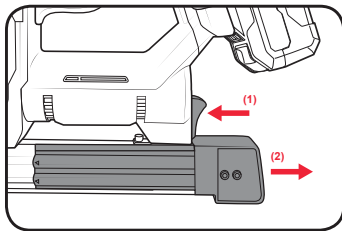

2. Insert a row of nails into the opening behind the nose piece. **Be sure to align them to the lower left corner of the cartridge.**

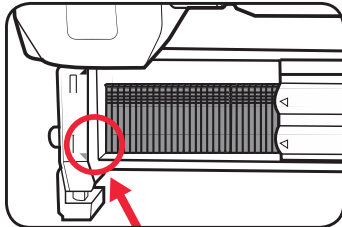

**Note:** Rows of more than 90 nails do not fit in the staple nail gun.

**Note:** Ensure nails are positioned correctly in the cartridge and not crooked or upside down.

3. Push the loaded magazine back into the unit until it clips into place.

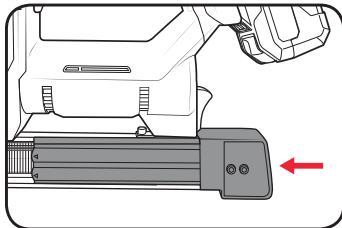

## 4. CONTROLS



**WARNING!** ALWAYS USE BOTH HANDS WHEN USING THE TOOL..

### Firing A Staple or Nail

The Safety Striker System is a two step process where a staple or nail will only fire when the safety striker guard is pushed against the material to be fastened.

1. With one hand, push down on the back of the tool to press the safety striker guard and nose piece down onto the work surface to be fastened.

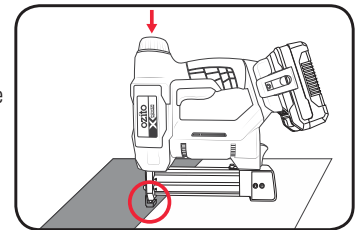

2. To fire the staple nail gun, squeeze the on/off trigger with your other hand.

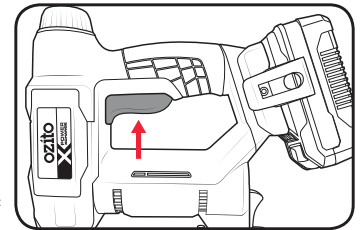

**Note:** Nails will be discharged off centre, to the right side of the nail gun. Test fire on scrap piece of wood to get the exact placement of the nail relative to the gun before use.

### Staple/Nail Firing Force Adjustment

Some jobs require a lighter touch than others; reducing the force that staples or nails are fired at reduces the chance of damaging thinner more delicate surfaces.

**Note:** Always test the setting on a piece of scrap material after making any adjustments.

1. To adjust the force of the staple nail gun, turn the dial clockwise to increase the strength.

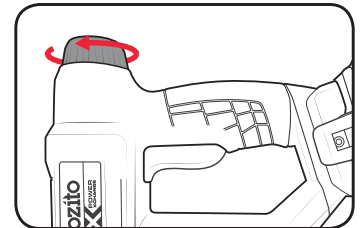

2. Turn the dial anti-clockwise to decrease the strength.

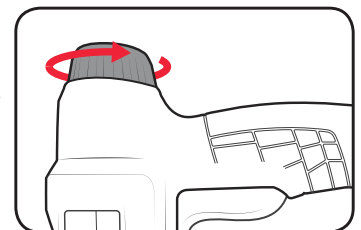

**Note:** If the nail/staple is not fully penetrating into the workpiece, firmly hold down the nail gun with two hands while firing.

## 5. TROUBLESHOOTING



**WARNING!** ENSURE THE TOOL IS SWITCHED OFF AND THE BATTERY IS REMOVED BEFORE PERFORMING ANY OF THE FOLLOWING TASKS.

### Jammed Staple or Nail

1. Press the cartridge latch down and pull the magazine slider out of the tool.
2. Using a pair of pliers, remove any jammed staples or nails.

3. With the magazine still open, tap the safety striker guard against a surface to dislodge any loose staples.

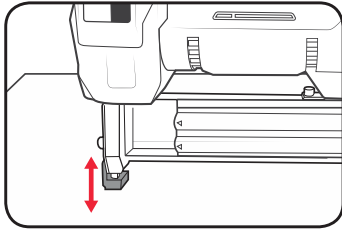

4. If the tool is still jammed, remove the rubber safety striker guard by pulling downward while wiggling side to side.

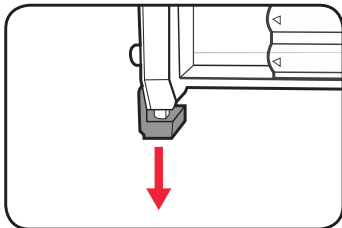

5. Use the hex key to loosen the bolts on the top of the tool.

**Note:** The bolts do not need to be completely unfastened to remove the nose plates.

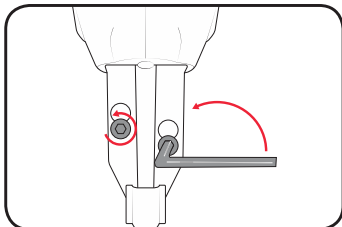

6. Slide the two nose plates down to align the holes with the bolts, then pull off, over the bolts.

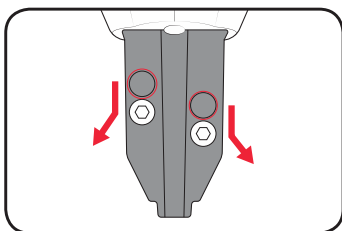

7. Gently lift up the tongue and dislodge any jammed fasteners with tweezers or needle nosed pliers.

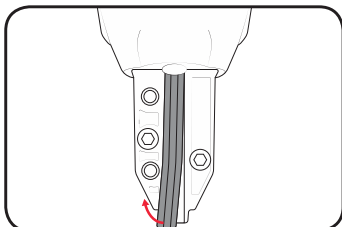

8. To reassemble, fit in the reverse order ensuring the nose plates are flush with the mounting plate and the safety pin is placed correctly between the two nose plates. Tighten the bolts and reattach the rubber guard.

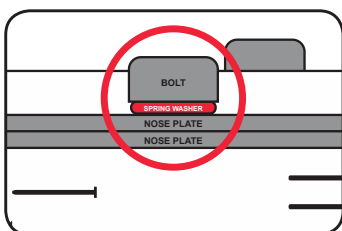

**Note:** Ensure that the spring washers are positioned between the bolt head and nose plate.

## MAINTENANCE



**WARNING!** BEFORE CLEANING OR CARRYING OUT ANY MAINTENANCE PROCEDURE, ENSURE THAT THE BATTERIES HAVE BEEN REMOVED.

### Short Battery Runtime

Ensure the battery is properly charged. It will take 4-5 charging cycles before the battery reaches optimum charge and run time.

When not in use, the staple nail gun should be stored in a dry, frost free location, keep out of children's reach.

If the housing of the staple nail gun requires cleaning, do not use solvents. Use of a cloth only is recommended. Never immerse any part of the staple nail gun into liquid.

**Note:** Ozito Industries will not be responsible for any damage or injuries caused by repair of the staple nail gun by an unauthorised person or by mishandling.

## DESCRIPTION OF SYMBOLS

<b>V</b>	Volts	<b>mm</b>	Millimeters
<b>A</b>	Amperes	<b>/min</b>	Per minute
	Wear ear & eye protection		Regulatory Compliance Mark (RCM)
	Read instruction manual		Warning

## CARING FOR THE ENVIRONMENT



Power tools that are no longer usable should not be disposed of with household waste but in an environmentally friendly way. Please recycle where facilities exist. Check with your local council authority for recycling advice.



Recycling packaging reduces the need for landfill and raw materials. Reuse of recycled material decreases pollution in the environment. Please recycle packaging where facilities exist. Check with your local council authority for recycling advice.

## SPARE PARTS

Spare parts can be ordered from the Special Orders Desk at your local Bunnings Warehouse.

For further information, or any parts not listed here, visit [www.ozito.com.au](http://www.ozito.com.au) or contact Ozito Customer Service:

Australia 1800 069 486

New Zealand 0508 069 486

E-mail: [enquiries@ozito.com.au](mailto:enquiries@ozito.com.au)

# ELECTRICAL SAFETY

 **WARNING!** When using mains-powered tools, basic safety precautions, including the following, should always be followed to reduce risk of fire, electric shock, personal injury and material damage.

Read the whole manual carefully and make sure you know how to switch the tool off in an emergency, before operating the tool.

Save these instructions and other documents supplied with this tool for future reference.

The charger has been designed for 230V and 240V only. Always check that the power supply corresponds to the voltage on the rating plate.

**Note:** The supply of 230V and 240V on Ozito tools are interchangeable for Australia and New Zealand.

 This tool's charger is double insulated; therefore no earth wire is required.

Note: Double insulation does not take the place of normal safety precautions when operating this tool. The insulation system is for added protection against injury resulting from a possible electrical insulation failure within the tool.

If the supply cord is damaged, it must be replaced by an electrician or a power tool repairer in order to avoid a hazard.

Using an Extension Lead

Always use an approved extension lead suitable for the power input of this tool. Before use, inspect the extension lead for signs of damage, wear and ageing. Replace the extension lead if damaged or defective.

When using an extension lead on a reel, always unwind the lead completely. Use of an extension lead not suitable for the power input of the tool or which is damaged or defective may result in a risk of fire and electric shock.

The power supply for this product's charger should be protected by a residual current device (rated at 30mA or less). A residual current device reduces the risk of electric shock.

# GENERAL POWER TOOL SAFETY WARNINGS

 **WARNING!** Read all safety warnings and all instructions. Failure to follow the warnings and instructions may result in electric shock, fire and/or serious injury. Save all warnings and instructions for future reference. The term "power tool" in the warnings refers to your mains-operated (corded) power tool or battery-operated (cordless) power tool.

## 1. Work area safety

- Keep work area clean and well lit.** Cluttered or dark areas invite accidents.
- Do not operate power tools in explosive atmospheres, such as in the presence of flammable liquids, gases or dust.** Power tools create sparks which may ignite the dust or fumes.
- Keep children and bystanders away while operating a power tool.** Distractions can cause you to lose control.

## 2. Electrical safety

- Power tool plugs must match the outlet.** Never modify the plug in any way. Do not use any adapter plugs with earthed (grounded) power tools. Unmodified plugs and matching outlets will reduce risk of electric shock.
- Avoid body contact with earthed or grounded surfaces, such as pipes, radiators, ranges and refrigerators.** There is an increased risk of electric shock if your body is earthed or grounded.
- Do not expose power tools to rain or wet conditions.** Water entering a power tool will increase the risk of electric shock.
- Do not abuse the cord.** Never use the cord for carrying, pulling or unplugging the power tool. Keep cord away from heat, oil, sharp edges or moving parts. Damaged or entangled cords increase the risk of electric shock.
- When operating a power tool outdoors, use an extension cord suitable for outdoor use.** Use of a cord suitable for outdoor use reduces the risk of electric shock.

## 3. Personal safety

- Stay alert, watch what you are doing and use common sense when operating a power tool.** Do not use a power tool while you are tired or under the influence of drugs, alcohol or medication. A moment of inattention while operating power tools may result in serious personal injury.
- Use personal protective equipment.** Always wear eye protection. Protective equipment such as dust mask, non-skid safety shoes, hard hat, or hearing protection used for appropriate conditions will reduce personal injuries.
- Prevent unintentional starting.** Ensure the switch is in the off-position before connecting to power source and/or battery pack, picking up or carrying the tool. Carrying power tools with your finger on the switch or energising power tools that have the switch on invites accidents.

- Remove any adjusting key or wrench before turning the power tool on.** A wrench or a key left attached to a rotating part of the power tool may result in personal injury.
  - Do not overreach.** Keep proper footing and balance at all times. This enables better control of the power tool in unexpected situations.
  - Dress properly.** Do not wear loose clothing or jewellery. Keep your hair, clothing and gloves away from moving parts. Loose clothes, jewellery or long hair can be caught in moving parts.
  - If devices are provided for the connection of dust extraction and collection facilities, ensure these are connected and properly used.** Use of dust collection can reduce dust-related hazards.
  - Do not let familiarity gained from frequent use of tools allow you to become complacent and ignore tool safety principles.** A careless action can cause severe injury within a fraction of a second.
- ## 4. Power tool use and care
- Do not force the power tool.** Use the correct power tool for your application. The correct power tool will do the job better and safer at the rate for which it was designed.
  - Do not use the power tool if the switch does not turn it on and off.** Any power tool that cannot be controlled with the switch is dangerous and must be repaired.
  - Disconnect the plug from the power source and/or the battery pack from the power tool before making any adjustments, changing accessories, or storing power tools.** Such preventive safety measures reduce the risk of starting the power tool accidentally.
  - Store idle power tools out of the reach of children and do not allow persons unfamiliar with the power tool or these instructions to operate the power tool.** Power tools are dangerous in the hands of untrained users.
  - Maintain power tools.** Check for misalignment or binding of moving parts, breakage of parts and any other condition that may affect the power tool's operation. If damaged, have the power tool repaired before use. Many accidents are caused by poorly maintained power tools.
  - Keep cutting tools sharp and clean.** Properly maintained cutting tools with sharp cutting edges are less likely to bind and are easier to control.
  - Use the power tool, accessories and tool bits etc. in accordance with these instructions, taking into account the working conditions and the work to be performed.** Use of the power tool for operations different from those intended could result in a hazardous situation.
  - Keep handles and grasping surfaces dry, clean and free from oil and grease.** Slippery handles and grasping surfaces do not allow for safe handling and control of the tool in unexpected situations.
- ## 5. Service
- Have your power tool serviced by a qualified repair person using only identical replacement parts.** This will ensure that the safety of the power tool is maintained.

# STAPLE NAIL GUN SAFETY WARNINGS

 This appliance is not intended for use by persons (including children) with reduced physical, sensory or mental capabilities, or lack of experience and knowledge, unless they have been given supervision or instruction concerning use of the appliance by a person responsible for their safety.

- Always assume that the tool contains fasteners.** Careless handling of the nailer or stapler can result in unexpected firing of fasteners and personal injury.
- Do not point the tool towards yourself or anyone nearby.** Unexpected triggering will discharge the fastener causing an injury.
- Do not actuate the tool unless the tool is placed firmly against the workpiece.** If the tool is not in contact with the workpiece, the fastener may be deflected away from your target.
- Disconnect the tool from the power source when the fastener jams in the tool.** While removing a jammed fastener, the tacker may be accidentally activated if it is plugged in.
- Do not use this nailer or stapler for fastening electrical cables.** It is not designed for electric cable installation and may damage the insulation of electric cables thereby causing electric shock or fire hazards.
- Always use both hands to operate the tool.** Your secondary hand should be used to press the back of the tool firmly down onto the surface to be fastened.