

# MAVEN 140IS

HOME IRONING STATION

LE SYSTÈME DE REPASSAGE POUR LA MAISON

EL SISTEMA HOGAREÑO DE PLANCHADO

INSTRUCTION MANUAL

GUIDE D'UTILISATION

MANUAL DE INSTRUCCIONES



THE MAVEN 140IS  
HOME IRON STATION  
INSTRUCTION MANUAL  
ENGLISH

## RELIABLE. RIGHT THERE WITH YOU.

At Reliable, we do what we love, and take pride in doing it right. You want what's best for the people, places and things that matter in your life - from where you live to what you wear. So do we. From the start, we approach every product with a craftsman's attention to detail and passion for making it right. Quality, functionality, design and customer service play an equally important part in delivering what's right for you.

For your safety and to fully enjoy the advantages of this product, please take a few minutes to read all the important safeguards and care instructions. Keep this manual handy and review the product warranty for your reference.

THANK YOU FOR YOUR PURCHASE. PLEASE SHARE YOUR RELIABLE PRODUCT EXPERIENCE BY POSTING AN ONLINE REVIEW ON THE WEBSITE FROM WHICH YOU PURCHASED. WE GREATLY APPRECIATE IT!



# IMPORTANT SAFEGUARDS - SAVE THESE INSTRUCTIONS IN A SAFE PLACE FOR FUTURE REFERENCE

## READ ALL INSTRUCTIONS BEFORE USE

When using your Maven 140IS home ironing station, basic safety precautions should always be followed. Please read the following instructions carefully as they provide important information concerning how to install, use and care for this product. The appliance is designed for domestic use and may only be operated in accordance with these instructions. The appliance generates high temperature steam. Always handle with care and warn other users of potential danger.

## DANGER TO CHILDREN



- This appliance is not suitable for use by people - including children - with reduced physical, sensorial or mental capabilities; by people with little or no experience or awareness of the appliance, unless carefully supervised or trained in the use of the appliance by a person responsible for their safety.
- It is necessary to supervise children to make sure that they do not play with the appliance.
- When disposing of the appliance as waste, it must be made inoperative by removing the power cord. Also remember to make any parts of the potentially hazardous parts of the appliance safe, as there is a risk that children may use them as playthings.
- Packaging elements must not be left in reach of children as they are potentially hazardous.

## ELECTRICAL DANGER



- Make sure that the power voltage of the appliance corresponds to that of your electricity.
- Always connect the appliance to a properly grounded socket.
- Never leave the appliance unattended when it is plugged in; unplug it after every use and before servicing.
- Always switch off the appliance using the main switch and unplug it from the socket before refilling it.
- Make sure that your hands are dry before using or adjusting the appliance switches, touching the plug or power connections.

## DANGER FROM OTHER CAUSES



- Never leave the appliance exposed to the elements (rain, sun, etc.).
- Never place the appliance on or near sources of heat.
- Make sure that the power cord does not come into contact with hot surfaces.
- Never point steam jets in the direction of people, animals or plants or towards appliances that contain electrical parts (e.g., oven interiors).
- Never direct steam jets onto the appliance itself.
- Never immerse the body of the appliance, plug or power cord in water or other liquids; clean them with a damp cloth.
- Never use the appliance if the power cord or plug are damaged or if the appliance is faulty/damaged.
- All repairs, including the replacement of the power cord, must only be carried out by Reliable corporation or technicians authorized by Reliable.
- This appliance has been designed for domestic use only and may not be used for commercial or industrial purposes. This appliance is for household use only.
- During use, the appliance contains pressurized steam: Improper use can be dangerous. The appliance is designed for domestic use only, as stated in the manual. The manufacturer cannot accept any liability for damage cause by improper or incorrect use of the appliance.
- When the appliance is not in use, always lock the steam dispensing button.

## SCALDING DANGER

- If the steam button is pressed before the boiler has reached the optimum temperature, then water instead of steam could come out of the nozzle.
- Never touch hot surfaces while using the product. Leave attachments to cool before replacing them.
- Even when the appliance is not in operation, unplug it from the power outlet and leave it to cool before inserting or removing single parts or before cleaning it.

### **NEVER OPEN THE CAP ON THE BOILER TANK DURING USE. BEFORE UNSCREWING THE CAP ON THE BOILER TANK, PROCEED AS FOLLOWS:**

- Switch off the appliance using the main switch.
- Release the remaining pressure from the boiler tank: using the steam button on the handle, point the jet into a suitable container.
- Leave the appliance to cool for a few minutes; slowly loosen the boiler tank cap partway and wait for a few seconds
- Unplug the power cord from the power outlet.

# RECOMMENDATIONS

## DO'S

1. Check that the main voltage stated on the rating plate corresponds to the local electricity supply.
2. Unwind and straighten the power cord and supply cord before use.
3. Place the appliance on a firm and steady surface.
4. The iron must be used and rested on a stable surface
5. Avoid the power cord or steam hose touching the soleplate.
6. Insert the anti-cal cartridge before use.
7. The plug of the power cord must be removed from the electrical outlet before the water reservoir is filled with water
8. Keep the anti-cal cartridge and granules away from children at all times.
9. Keep electrical appliances out of reach of children. Do not let them use the appliances without supervision.
10. When placing the appliance on its stand, ensure that the surface on which the stand is placed is stable.
11. If the power cord or supply cord is damaged, the manufacturer, its service agent or a similarly qualified person must replace it in order to avoid a hazard.
12. Empty the water tank after use.
13. Do not allow children to play with the appliance.
14. This appliance can be used by children aged 8 years and above and persons with reduced physical, sensory or mental capabilities or persons that lack experience and knowledge if they are being supervised and instructed in the use of the appliance in a safe way and understand the hazards involved.
15. Keep the iron and its cord out of reach of children less than 8 years of age when it is on or cooling down.
16. Always turn the iron OFF before plugging or unplugging the iron from the electrical outlet. Never pull on the cord to disconnect the iron from the electrical outlet; instead, grasp the plug and pull on the plug to disconnect the iron.
17. Always disconnect the iron from the electrical outlet before filling the iron with water, emptying the water from the iron and when the iron is not in use.
18. Burns can occur from touching hot metal parts, hot water, or steam. Use caution when you turn a STEAM IRON upside down - there might be hot water in the reservoir.
19. If an extension cord is absolutely necessary, a cord with an ampere rating equal to or greater than the maximum rating of the iron shall be used. A cord rated for less amperage can result in a risk of fire or electric shock due to overheating. Care shall be taken to arrange the cord so that it cannot be pulled or be tripped over.

# CAUTION

## DONT'S

1. Do not allow children to touch the appliance when ironing.
2. Do not leave the appliance unattended when it is connected to a main supply outlet.
3. Do not use an extension power cord set unless it corresponds with your local manufacturing standards.
4. Do not add perfume, vinegar or anything other than water into the water tank; this can seriously damage the appliance.
5. Do not immerse the appliance in water or any other liquids.
6. Do not use the appliance if it is damaged or performs abnormally.
7. Do not use the appliance if it has been dropped, if there are visible signs of damage or if it is leaking.
8. Do not touch the iron rest during or just after ironing. It is hot!
9. Do not roll the power cord or supply cord around the iron unit or base for storage until it has cooled down completely.
10. Do not attempt to open the water tank or dismantle any part of the appliance, there are no serviceable parts inside.
11. Do not open the water inlet cover during use. See instructions for the safe refilling of the water tank.
12. Cleaning and user maintenance should not be done by children without supervision.
13. Do not touch the surfaces marked with this symbol during or just after ironing. The appliance will be hot! (Please refer to the following figure 1 and figure 2)
14. Do not let the cord touch hot surfaces. Let the iron cool completely before putting the iron away. Coil the cord loosely around the iron when storing.
15. Do not operate the iron with a damaged cord or in the event the iron has been dropped or damaged. To avoid the risk of electric shock, do not disassemble the iron. Take it to a qualified serviceman for examination and repair. Incorrect assembly might result in a risk of electric shock when the iron is used after reassembly.
16. To avoid a circuit overload, do not operate an iron on the same circuit with another high wattage appliance.

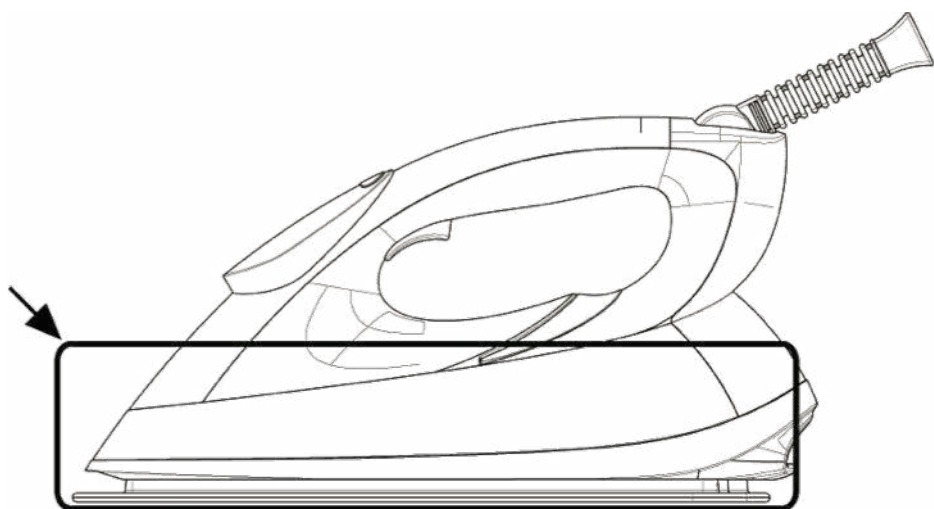

**CAUTION: Hot Surface!**

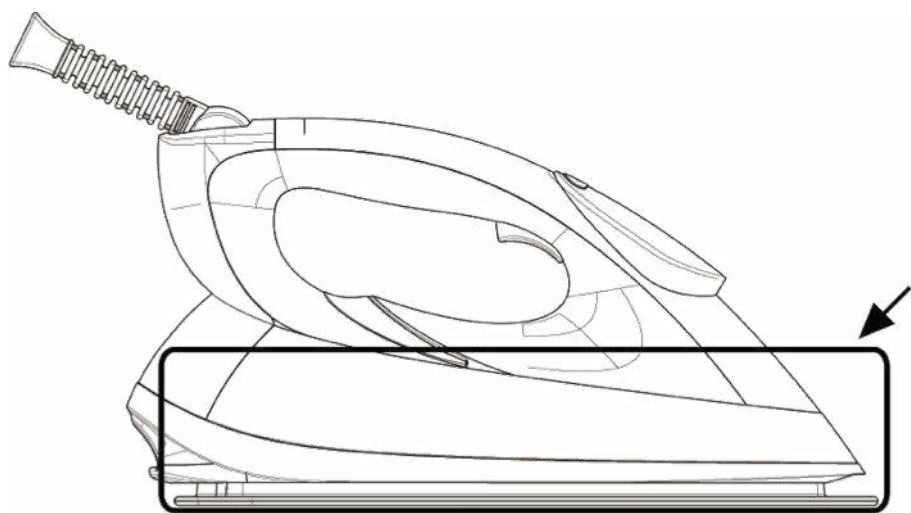





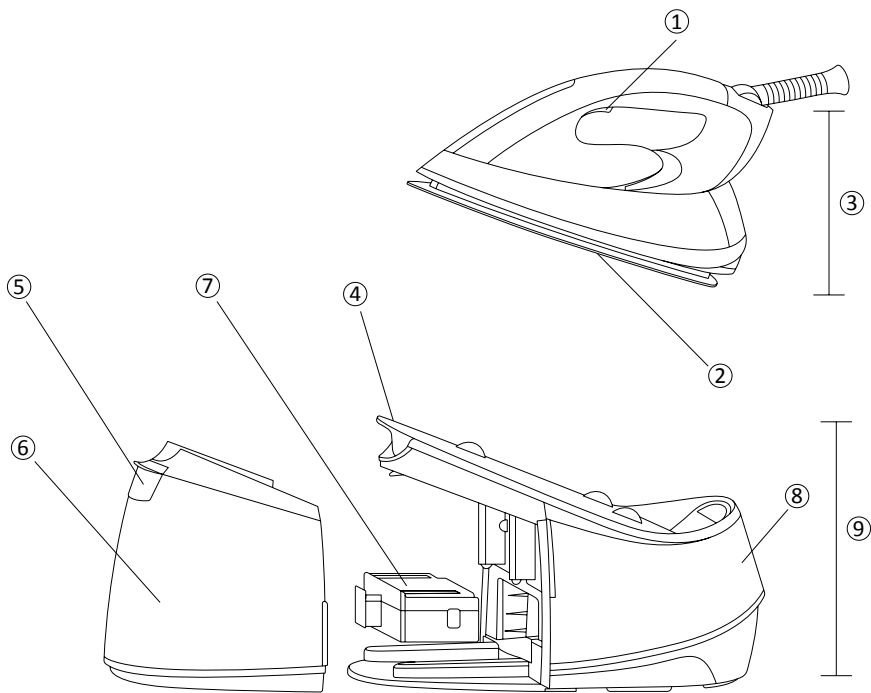

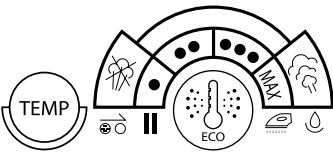

**CAUTION: Hot Surface!**

# MAVEN 140IS KEY FEATURES



1. Steam Trigger	7. Anti-scale Cartridge
2. Soleplate	8. Control Panel
3. Iron Unit	9. Base Unit
4. Carry Lock	
5. Water Inlet Cover	
6. Water Tank	

# CONTROL PANEL

		No Steam Indicator
		Steam Level Indicator
		Anti-scale Cartridge Indicator
		Temperature Settings
		Temp Mode Indicator
		Auto Shut Off Indicator
		Self-clean Indicator
		Low Water Indicator

## BEFORE THE FIRST USE

1. Remove any protective films or stickers from the appliance
2. Unwind and straighten the power cord.
3. Remove the cover from the new anti-scale cartridge.
4. Immerse new anti-scale cartridge into water for 5 minutes before first use for improved performance (Figure 1)

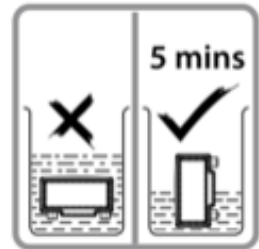

FIGURE 1

Note: When using the steam function for the first time, do not use on your laundry. Some residue may remain inside the appliance. Iron an old towel for the first time and press the steam trigger to ensure the residue is completely released.

## USING YOUR APPLIANCE

1. This appliance is designed for use with normal tap water. Other liquids might damage the appliance.
2. Connect the appliance to a suitable main supply outlet.
3. Start ironing after the icons on the display panel stop flashing. This indicates the required temperature has been reached and the appliance is ready to use.
4. Always disconnect the appliance from the main power supply after use.

## IMPORTANT:

During first time use, it may take 10-30 seconds for steam to start. This may take longer if cartridge is not completely soaked.

Your unit may make “chugging” noises upon initial use. This is normal. It is simply the water drawing into the unit. As noted above, this chugging may take 10-30 seconds when first using your Maven 140IS. Hold down the steam button to assist with the water drawing process. If your unit requires more water, refill your water tank.

We recommend you change your descaling cartridge every 3 to 6 months. If user does not place the anti-scale cartridge correctly, the unit may not be able to generate steam.

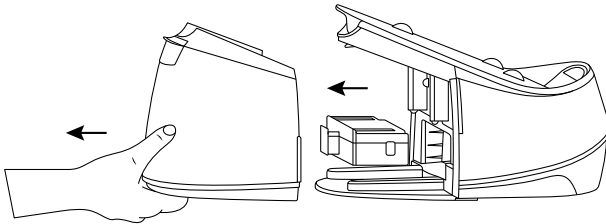

# FILLING THE WATER TANK

1. Disconnect the power cord from the electric outlet.
2. Pull out the water tank (Figure 2).
3. Open the water inlet cover and fill tank with water until the maximum level (Figure 3).
4. Put the water tank back and make sure that it is firmly positioned in place (Figure 4).

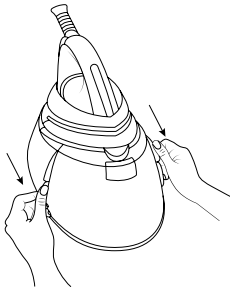

**FIGURE 2**

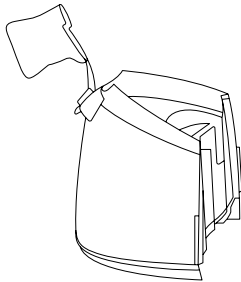

**FIGURE 3**

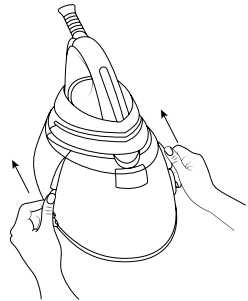

**FIGURE 4**

# CARRY LOCK

The appliance is equipped with a carry lock. You can carry the appliance with one hand using the handle of the iron unit when the iron is locked to the base (Figure 5). To release the iron unit from the base, turn the carry lock to the unlocked position.

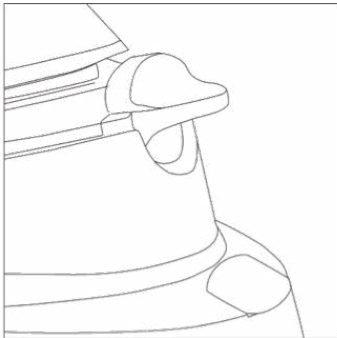

**FIGURE 2**

**Locked Position**

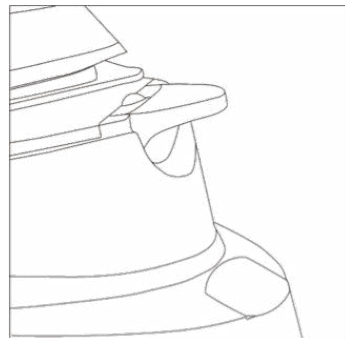



**FIGURE 3**

**Unlocked Position**

# PROGRAMMED TEMPERATURE

## Auto Mode

The appliance is equipped with a programmed temperature feature which allows it to iron all ironable fabrics without adjusting the temperature of the iron. It is the default mode of this appliance.

	Fabrics with these symbols are ironable, for example, Polyester, Silk, Viscose, Wool, Cotton and Linen.
	Fabrics with this symbol are not ironable, for example, Polypropylene, Elastane and Acrylic Fabric.

The ECO indicator will light up when the lowest temperature is being used.



# SETTING THE TEMPERATURE

The appliance has different temperature settings for different kinds of fabrics. Press the function button to turn on the appliance. The appliance will start in auto mode. If you want to switch to another ironing temperature, press the function key and the temperature display will loop through the following sequence:

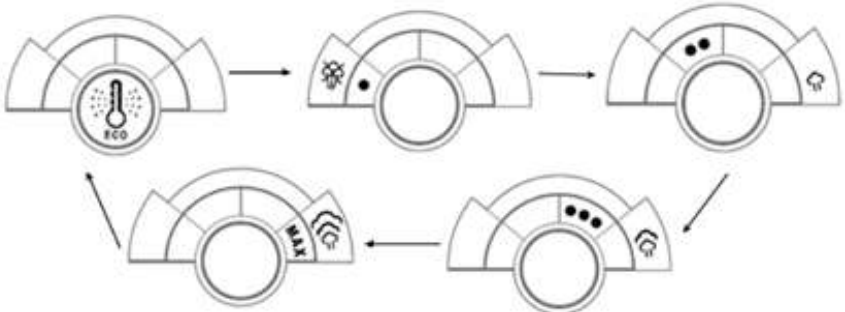
'auto mode' -> 'Dot 1' -> 'Dot 2' -> 'Dot 3' -> 'Dot 4' -> 'Max'



**IMPORTANT** Before starting to iron, read the garment labels and follow the manufacturer's ironing instructions.





TEMPERATURE CONTROL SETTINGS		
		
Acetate Elastane Polyamide	Polyester Silk Viscose Wool	Cotton Linen

If you are not sure about the fabric is made of, use the auto mode or start ironing at a low temperature.

## AUTO STEAM FUNCTION

The appliance will automatically adjust the steam output to the selected temperature. The function provides the right amount of steam for each temperature to achieve the best results.

# PROGRAMMED TEMPERATURE

<p>The appliance will start at eco mode after plug-in, touch the temp button to switch to other ironing temperatures and select your desired temperature to begin. A “Beep” sound will be heard when the function button is being touched.</p>	
<p>Depending on which temperature setting that you have selected, the corresponding temperature symbol on the control panel will be flashing. When the iron is ready for use, the temperature symbol stops flashing and stays on steadily.</p>	
<p><b>Important note: The first time you use the iron, the pump will take a few seconds to generate steam. During this time, you may hear a “pumping” sound. This is normal and will occur before the iron is ready to use.</b></p>	
<p>Steam ironing is available for all temperature settings except ‘Dot 1’. You can press and hold the steam trigger to generate steam for steam ironing. A beep will be heard when the steam trigger is pressed and the respective steam indicator for ‘Auto Mode’, ‘Dot 2’, ‘Dot 3’ and ‘Max’ will flash, indicating it is generating steam. Release the steam trigger to stop generating steam.</p>	
<p>Adjust the temperature setting of the appliance by pressing the temp button.</p>	
<p>After use, Touch and hold the temp button for 4 seconds to shut off the power. Auto Shut off/shut off Indicator flashes during this period.</p>	
<p>After every use, follow the instructions in “Draining the water tank”.It is recommended to drain the water inside water tank after use.</p>	

# VERTICAL STEAMING

You can remove wrinkles from garments, curtains and fabrics in hanging positions.

1. Select your desired steam temperature setting.
2. Hold the iron in a vertical position (Figure 7) 15 to 30 centimeters away from the garment.
3. Press the steam trigger.

**Warning:** Do not apply steam to clothes or fabrics that are being worn by humans or pets. The temperature of the steam is very high.

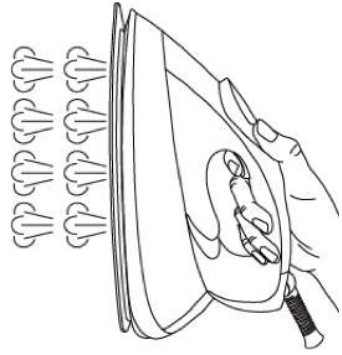
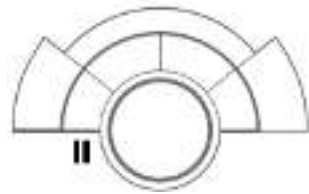

**FIGURE 7**

# SAFETY AUTO SHUT-OFF FUNCTION

The auto shut-off function will operate automatically when the iron is immobile or the function button or steam trigger have not been pressed for 10 minutes.

1. A beep will be heard and the auto shut-off indicator will be flashing (Figure 8) to indicate the appliance is in auto shut-off mode.
2. To reactivate the iron, touch and hold the function button for 1 second. The control panel will resume to its previous temperature setting and start heating up. It takes about 60 seconds for the iron to be ready for use.



**FIGURE 8**

**Note:** The appliance is not switched completely when it is in auto shut-off mode. Press and hold the function button to turn the appliance off completely, and unplug from the main power supply outlet.

# DRAINING THE WATER TANK

Disconnect the iron from the main supply outlet

1. Pull out the water tank (Figure 9).
2. Open the Water Inlet Cover and drain the water tank (Figure 10).
3. Put the water tank back and make sure that it is firmly positioned in place (Figure 11)



FIGURE 9



FIGURE 10



FIGURE 11

# ANTI-SCALE CARTRIDGE

This appliance has an anti-scale cartridge to prolong its lifespan.

1. When the anti-scale cartridge indicator lights up, it indicates the anti-scale cartridge needs to be changed. It is very important to change the cartridge before continuing to iron.
2. Remove the cover from the new anti-scale cartridge.
3. Immerse the new anti-scale cartridge into water for 5 minutes (Figure 13) before first use for better performance.
4. Press to release the cartridge from the appliance and pull out the old cartridge from the appliance (Figure. 14)  
**Caution: The cartridge can be very hot due to the heat heat from the soleplate. Make sure the cartridge has cooled down before pressing it.**
5. Insert the new anti-scale cartridge (Figure 15)



FIGURE 12



FIGURE 13



FIGURE 14



FIGURE 15

**Note:** If the anti-scale cartridge is not installed, or installed incorrectly, you will not be able to use the appliance.



**FIGURE 16**

**Note:** If the prompt light appears a long time or does not shut off, remove the anti-scale cartridge when the product is powered on and reinstall the new anti-scale cartridge. Unplug the unit from power, press the steam button and plug the unit back in. The symbol will then disappear.

## SELF CLEANING

This function removes the scale and mineral build-up from the steam chamber. The appliance will remain in the best condition if this function is performed at least once a month or more often, depending on the hardness of water used.

1. When the self-clean indicator lights up with a beep, it indicates that the appliance needs to undergo a self-cleaning (Figure 17).
2. Fill the water tank to the max level (See 'FILLING THE WATER TANK') and plug in the appliance.
3. Press the function (temp) button followed by the steam trigger and hold both buttons for 3 seconds. The appliance will then enter self-cleaning mode with a beep sound.
4. Press the function (temp) to proceed with self-cleaning. Press the steam trigger to resume ironing. (Note: when self-cleaning is confirmed, you will not be able to terminate it until the process is completed).
5. Hold the iron about 15 centimeters above the sink in the ironing position. Loose material and water will come out through the steam holes (Figure 18). The appliance will resume the previous ironing setting when this is complete.
6. Iron with a damp cloth to remove any deposits on the soleplate. Remove any water stains that may have formed on the soleplate.
7. Press and hold the function (temp) button to turn the appliance off and unplug from the main power supply outlet.



**FIGURE 17**



**FIGURE 18**

## CLEANING AND MAINTENANCE

1. Disconnect the power cord from the main power supply.
2. Use a damp cloth to remove deposits from the soleplate and exterior parts of the iron.
3. Never use sharp or rough objects to remove deposits from the sole plate.

## STORAGE

1. Make sure the water is completely drained from the water tank
2. Place the iron unit on the base.
3. Turn the carry lock to the lock position.
4. You can carry the appliance with one hand by the handle of the iron unit when the iron is locked on the base.

## IRONING TIPS

1. Sort out articles to be ironed according to types of fabric. This will minimize the frequency of temperature adjustments.
2. Test iron a small area on the backside or inside the garment if you are unsure about the type of fabric. Start with a low temperature and increase gradually.
3. Wait 2 minutes between temperature adjustments while ironing heat sensitive fabrics.

# TROUBLESHOOTING

If your steam station does not work well, check the following points:

PROBLEM	CAUSE	SOLUTION
The unit does not work	There is not enough heat	Wait for unit to heat up
	It is not plugged in	Plug unit in
	The anti-scale cartridge is not installed/installed improperly	Install the scale cartridge properly
	Socket doesn't work	Plug into a functioning socket
No steam coming out when pressing the steam trigger	Water tank empty	Fill water tank
	The appliance is still heating up	Wait for unit to heat up
	Steam ironing is not available	Press the function button for a higher temperature setting
Sole-plate doesn't heat well	Incorrect fabric setting	Press the function button for a higher temperature setting
Loud noise	First time use	This is normal
	Water tank is empty	Fill water tank

Reliable Corporation (“Reliable”) warrants to original purchaser of its products that every product sold by Reliable (a “Reliable Product”) is free from defects in material and workmanship for a period of one year from the date of purchase if properly used and maintained. Subject to the conditions and limitations set forth below, Reliable will either repair or replace any part of a Reliable Product that proves defective by reason of improper workmanship or materials. If the defective Reliable Product is no longer available and cannot be repaired effectively or replaced with an identical model, Reliable shall replace the defective Reliable Product with a current Reliable Product of equal or greater value. Repaired parts or replacement products will be provided by Reliable on an exchange basis, and will be either new or refurbished to be functionally equivalent to new. If Reliable is unable to repair or replace a Reliable Product, it will refund the current value of that Reliable Product at the time the warranty claim is made.

This limited warranty does not cover any damage to a Reliable Product that results from improper installation, accident, abuse, misuse, natural disaster, insufficient or excessive electrical supply, abnormal mechanical or environmental conditions, wear and tear resulting from normal use of the product, or any unauthorized disassembly, repair, or modification. This limited warranty does not extend to any indirect, consequential or incidental damages that may be suffered by a user or from the use of a Reliable Product, including without limitation, any liability for third party claims for damage, and is limited to the amount paid by the original purchaser Reliable Product with respect to which this limited warranty protection applies. This limited warranty does not apply with respect to products that have been altered or which are missing serial numbers or for products not purchased directly from Reliable or a dealer authorized by us to sell Reliable Products.

This limited warranty is the only warranty that applies to any Reliable Product, supersedes any and all terms that may be contained in any other document or purchase order and may not be altered or amended except expressly in writing by Reliable.

To obtain a repair or replacement under the terms of this warranty, please contact our customer service group at 1-800-268-1649 or at [support@reliablecorporation.com](mailto:support@reliablecorporation.com). You will be required to submit an original receipt via fax or e-mail. The receipt must reflect that you are the original purchaser, the product was bought directly from us or from an authorized Reliable dealer and that the warranty claim is being made within the warranty period. You will be issued a return authorization number (RA#) and asked to ship the defective product together with proof of purchase and RA#, prepaid insured to the following address:

Reliable Corporation, 5-100 Wingold Avenue, Toronto, ON M6B 4K7. Freight collect shipments will be refused. The risk of loss or damage in transit will be borne by the customer. Once Reliable receives the defective product, it will initiate the repair or replacement process.

If you have any questions regarding this warranty, you may write to:

Reliable Corporation  
100 Wingold Avenue, Unit 5  
Toronto, Ontario  
Canada M6B 4K7  
[www.reliablecorporation.com](http://www.reliablecorporation.com)



1 800 268 1649  
[www.reliablecorporation.com](http://www.reliablecorporation.com)