

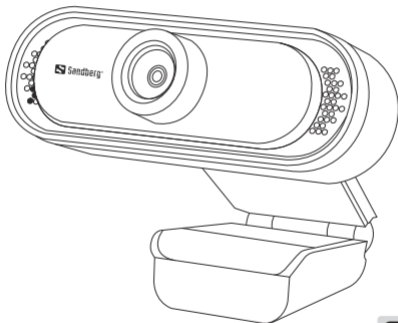

# USB Webcam 1080P Saver

Quick guide

333-96



[www.sandberg.world](http://www.sandberg.world)

## Overview

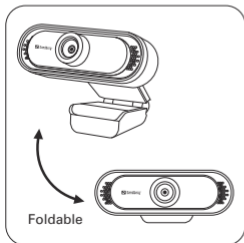
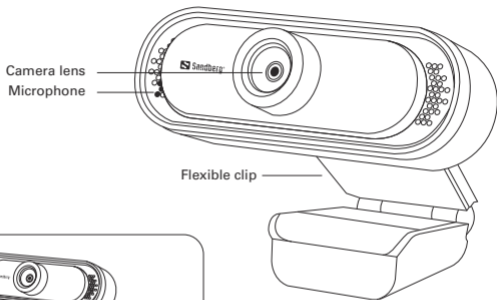

## Connection

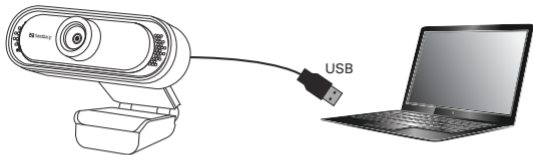

## Mounting

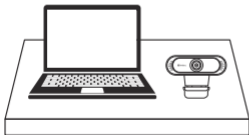

On a Desk

OR

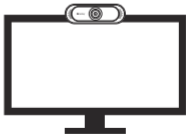

On a PC Monitor

## Function

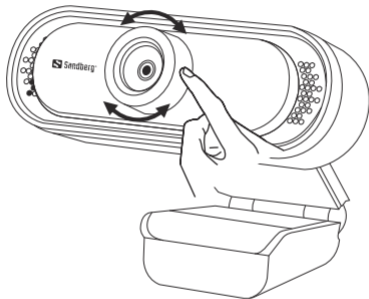

Focus adjustment

