

Thank you for purchasing a Sealey Welder. Manufactured to a high standard this product will, if used according to these instructions and properly maintained, give you years of trouble free performance.



IMPORTANT: BEFORE USING THIS PRODUCT, PLEASE READ THE INSTRUCTIONS CAREFULLY. MAKE CAREFUL NOTE OF SAFETY INSTRUCTIONS, WARNINGS AND CAUTIONS. THIS PRODUCT SHOULD ONLY BE USED FOR ITS INTENDED PURPOSE. FAILURE TO DO SO MAY CAUSE DAMAGE OR PERSONAL INJURY, AND WILL INVALIDATE THE WARRANTY. RETAIN THESE INSTRUCTIONS FOR FUTURE USE.

1. SAFETY INSTRUCTIONS

1.1. ELECTRICAL SAFETY

- WARNING!** It is the responsibility of the owner and the operator to read, understand and comply with the following:
You must check all electrical products, before use, to ensure that they are safe. You must inspect power cables, plugs, sockets and any other connectors for wear or damage. You must ensure that the risk of electric shock is minimised by the installation of appropriate safety devices. A Residual Current Circuit Breaker (RCCB) should be incorporated in the main distribution board. We also recommend that a Residual Current Device (RCD) is used. It is particularly important to use an RCD with portable products that are plugged into a supply which is not protected by an RCCB. If in any doubt consult a qualified electrician. You may obtain a Residual Current Device by contacting your Sealey dealer. You must also read and understand the following instructions concerning electrical safety.
- 1.1.1. The **Electricity at Work Act 1989** requires that all portable electrical appliances, if used on business premises, are tested by a qualified electrician, using a Portable Appliance Tester (PAT), at least once a year.
- 1.1.2. The **Health & Safety at Work Act 1974** makes owners of electrical appliances responsible for the safe condition of those appliances and the safety of the appliance operators. **If in any doubt about electrical safety, contact a qualified electrician.**
- 1.1.3. Ensure that the insulation on all cables and on the appliance is safe before connecting it to the power supply. See 1.1.1. and 1.1.2. and use a Portable Appliance Tester.
- 1.1.4. Ensure that cables are always protected against short circuit and overload.
- 1.1.5. Inspect power supply cables and plugs regularly for wear or damage and check all connections to ensure that none is loose.
- 1.1.6. Important: Ensure that the voltage marked on the appliance matches the power supply to be used and that the supply is correctly fused.
- 1.1.7. **DO NOT** pull or carry the appliance by the power cable.
- 1.1.8. **DO NOT** pull the plug from the socket by the cable.
- 1.1.9. **DO NOT** use worn or damaged cables, plugs or connectors. Have any faulty item repaired or replaced immediately by a qualified electrician.
- 1.1.10. **INVMIG200** is a single phase machine and must be run from a minimum 32A supply. **To achieve maximum output this model will require a 32A fused supply. We recommend you discuss the installation of an industrial round pin plug and socket with a qualified electrician.**

1.2. GENERAL SAFETY

- ▲ DANGER! Unplug the welder from the mains power supply before performing maintenance or service.**
- ✓ Keep the welder and cables in good condition. Take immediate action to repair or replace damaged parts.
- ✓ Use genuine parts and accessories only. Unapproved parts may be dangerous and will invalidate the warranty.
- ✓ Use an air hose to regularly blow out any dirt from the liner and keep the welder clean for best and safest performance.
- ✓ Check and spray the gas cup and contact tip regularly with anti-spatter spray, which is available from your Sealey dealer.
- ✓ Locate the welder in a suitable work area. Ensure that the area has adequate ventilation as welding fumes are harmful.
- ✓ Keep work area clean, tidy and free from unrelated materials. Also ensure that the work area has adequate lighting and that a fire extinguisher is to hand.
- WARNING! Use a welding head shield to protect eyes and avoid exposing skin to ultraviolet rays given off by electric arc. Wear safety welding gauntlets.**
- ✓ Remove ill fitting clothing, remove ties, watches, rings and other loose jewellery and contain long hair.
- ✓ Ensure that the workpiece is correctly secured before operating the welder.
- ✓ Avoid unintentional contact with workpiece. Accidental or uncontrolled use of the torch may be dangerous and will wear the nozzle.
- ✓ Keep unauthorised persons away from the work area. Any persons working within the area must wear protective head shield and gloves.
- ✓ Operators must receive adequate training before using the welder.
- ✓ Stand correctly, keeping a good footing and balance, and ensure that the floor is not slippery. Wear non-slip shoes.
- ✓ Turn machine OFF when not in use.
- X **DO NOT** operate the welder if it or its cables are damaged and **DO NOT** attempt to fit any unapproved torch or other parts to the welder unit.
- X **DO NOT** get welder wet or use in damp or wet locations or areas where there is condensation.
- ▲ DANGER! DO NOT weld near flammable materials, solids, liquids, or gases, and DO NOT weld containers or pipes which have held such products. Avoid operating on materials cleaned with chlorinated solvents or near such solvents.**
- X **DO NOT** stand welder on a metal workbench, car bodywork or similar object.
- X **DO NOT** touch any live metal parts of the torch or electrode while the machine is switched on.
- X **DO NOT** pull the welder by the cable or the torch and **DO NOT** bend or strain cables. Protect cables from sharp or abrasive items and **DO NOT** stand on them. Protect from heat. Long lengths of slack must be gathered and neatly coiled. **DO NOT** place cables where they could endanger other people.
- X **DO NOT** touch the torch or workpiece immediately after welding as they will be very hot. Allow to cool.
- X **DO NOT** operate welder while under the influence of drugs, alcohol or intoxicating medication, or if tired.
- ✓ When not in use store the welder in a safe, dry, childproof area.

1.3. GAS SAFETY

- ✓ Store gas cylinders in a vertical position only and ensure that the storage area is correctly secured.
- x **DO NOT** store gas cylinders in areas where temperature exceeds 50°C. **DO NOT** use direct heat on a cylinder. Always keep gas cylinders cool.
- x **DO NOT** attempt to repair or modify any part of a gas cylinder or valve and **DO NOT** puncture or damage a cylinder.
- x **DO NOT** obscure or remove any official cylinder labels. Always check the gas identity before use. Avoid getting gas cylinders oily or greasy.
- x **DO NOT** lift a cylinder by the cap, guard or valve. Always keep caps and guards in place and close valve when not in use.

2. INTRODUCTION & SPECIFICATION

2.1. Manufactured with a pressed steel outer casing giving this unit a weight of only 21kg. Inverter welders offer many advantages over traditional transformer type welders. This 4-in-1 welder uses state-of-the-art technology to achieve TIG/MIG/arc and spot welding. Automatic Arc-Force circuitry makes this unit suitable for arc welding a variety of rods including rutile, basic and stainless from Ø1.6mm to Ø4.0mm. Fan cooled DC power supply for MIG and TIG, suitable to weld steel, stainless steel, copper, nickel, titanium and their alloys. Rotary switch to allow operator to switch between MIG, TIG and arc welding modes. Features high frequency start to enable fast and responsive striking of the arc. Thermal overload protection which automatically switches unit off when it exceeds maximum temperature. Fully functional front panel with self explanatory pictures for each dial and switch, making this easier and accessible to use. Features LED display which displays voltage and/or current depending on welding mode selected. Wire feed control used to control the speed of wire fed through the torch during welding. Spot welding time control allows adjustment from 1-8 seconds. Burn back time control allows the operator to manually choose desired length of electrode wire which protrudes from torch after welding. Polarity change terminals allow the operator to change polarity of welding torch depending on whether the applications are MIG welding or flux-cored welding. Includes 3mtr MIG torch, 2.5mtr earth cable, gas hose and regulator and 0.6/0.8 contact tips.

2.2. **IMPORTANT:** These instructions contain information you require to prepare your machine for welding, together with a maintenance section. If you have no previous experience the instructions are not intended to show you how to become a welder. Should you have no experience, we recommend that you seek training from an expert source. MIG welding is relatively easy to perform, but does require a steady hand and time practising under supervision with scrap metal as it is only with continued practice that you will achieve the desired results.

Model No:	INVMIG200
Duty Cycle, MIG:	20% @ 200A, 60% @ 115A
TIG:	20% @ 200A, 60% @ 115A
Arc (MMA):	20% @ 170A, 60% @ 100A
Electrode Capacity:	Ø1.6 - 4.0mm
Maximum Wire Spool:	5kg
Absorbed Power:	9.3kW
Supply:	230V ac
Insulation:	F
Protection:	IP21S
Weight:	21kg

3. PREPARATION FOR MIG WELDING

NOTE: The main (On/Off) switch is located on the rear plate of the machine. The power indicator light (fig.1.2) is lit when the welder is live.

3.1. Switch selector switch to position 'MIG' (right hand) position (fig.1.1).

3.2. COUPLING TO GAS CYLINDER.

ATTACHING THE REGULATOR. (fig.2) Whichever gas you are using it is advisable to 'crack' the cylinder valve before attaching the regulator. This means opening and closing the valve very quickly in order to blow away any dust and dirt that may have accumulated in the gas outlet. Stand to one side whilst doing this.

3.2.1. **CO₂ GAS.** Ensure that the threads on the gas bottle are undamaged and free of oil and grease before attaching the regulator. (Oil or grease in the presence of high pressure gases can be explosive.) Ensure that the regulator has an undamaged gasket fitted. The regulator will screw directly to the threads on the gas bottle. Tighten with a wrench.

3.2.2. **ARGON GAS OR ARGON MIXTURES.** Cylinders containing argon gas and argon mixtures have a female thread and will require the use of a Bull Nose Adaptor to attach the regulator to the cylinder as indicated in fig.2. Ensure that the threads on the gas bottle are undamaged and free of oil and grease before attaching the regulator. (Oil or grease in the presence of high pressure gases can be explosive.) Fit the Bull Nose Adaptor to the cylinder first and tighten with a wrench.

3.2.3. Slide a hose clip over each end of the gas hose supplied. Push one end of the hose onto the regulator outlet and the other end over the gas inlet spigot on the back of the welder. Tighten the clips to ensure a good seal.

3.2.4. Close the regulator valve by turning it anticlockwise before opening the cylinder valve. Stand to one side when opening the cylinder valve.

3.2.5. Set the regulator flow rate to 5-8 litres/min depending on the material to be welded, and whether there are draughts which are strong enough to disturb the gas flow.

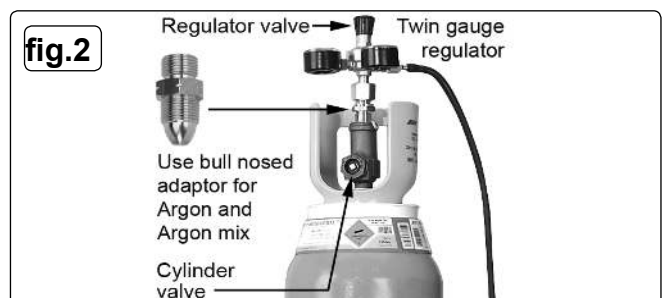

- 3.3. **CONNECTING THE TORCH CABLE TO THE WELDER.** Align the pins on the Euro connector with the socket on the welder front panel as shown in fig.3. Push the connector into the socket and rotate the locking ring (A) clockwise so that it draws the plug into the socket as shown in fig.4.

Note: damage to torches and cables is not covered by warranty.

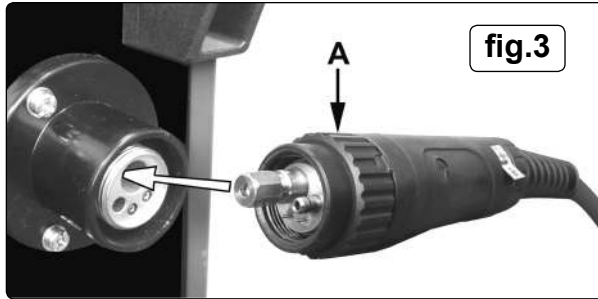

- 3.4. **FITTING A REEL OF WIRE (FIG.5).** INVMIG200 will accept up to a 5kg reel of wire. Ensure that the wire diameter used is matched by the correct groove size in the drive wheel and the correct tip size on the torch as well as the correct torch liner. Failure to do this could cause the wire to slip and/or bind.

- 3.4.1. Remove the retaining knob (D) from the end of the spindle (A) by turning the knob 90° anticlockwise and pulling it outwards. Remove the spring (C) and the retaining disc (B) from the end of the spindle also. Slide the reel of wire over the spindle and hold it against the back plate so that the hole in the reel rests on the flange (E). Ensure that the wire is coming off the top of the reel in the direction of the wire drive unit as shown in fig.6.

- 3.4.2. Retain hand pressure on the reel to keep it on the flange and slide the retaining disc (B) over the end of the spindle and into the hole in the reel. Note that the disc (B) has a hexagonal hole in it which fits onto the hexagonal portion of the spindle. Keep the disc under hand pressure to retain the reel. Place the spring (C) over the spigot of the retaining knob (D). Match the indented end of the spigot to the hole in the end of the spindle. Push the knob spigot into the end of the spindle, against spring pressure and turn it through 90° to lock it in place.

- 3.5. **FEEDING WIRE THROUGH TO TORCH.** Open the wire feed mechanism by pushing the locking/wire tension knob (fig.7.1) down to the right allowing the pressure roller carrier (fig 7.2) to spring up revealing the feed roller. Ensure that the required feed groove (0.6 or 0.8) is in line with the wire path. See Section 3.7. on how to reverse or change the roller.

- 3.5.1. Release the wire from the reel and cut off any bent portion ensuring that there are no burrs left on the end of the wire. **Keep the wire under tension at all times to prevent it uncoiling.**

- 3.5.2. Straighten about 40-50mm of wire and push it gently through the flexible metal sheathed cable (fig7.3) and through the 0.6mm or 0.8mm feed roller groove and on into the torch cable liner.

- 3.5.3. Push down the pressure roller carrier onto the wire feed roller and hold it down. Lift up the locking/wire tension knob so that it enters the slot in the pressure roller carrier and snaps into the indent in its top surface (fig.7). Rotate the tension knob to a medium setting i.e. between 2 and 3.

- 3.5.4. Remove gas cup (fig.8.2) and contact tip (fig.8.1) from end of torch as follows:

- Take torch in left hand with the torch tip facing to the right.
 - Grasp gas cup firmly in your right hand.
 - Turn gas cup clockwise only and pull it off end of torch tip.
- ⚠ **WARNING!** do not turn gas cup anti-clockwise, as this will damage the internal spring.
- Unscrew copper contact tip (right hand thread) to remove.

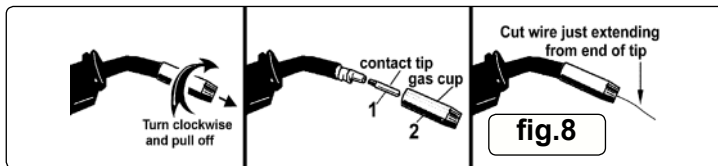

- 3.5.5. Check welder is switched off and that the earth clamp is away from the torch tip. Connect the welder to the mains power supply and set the voltage switch (fig1.6) to '1'.

- 3.5.6. Set the wire speed knob (fig1.7) to position 5 or 6. Keep the torch cable as straight as possible and press the torch switch. The wire will feed through the torch.

- 3.5.7. a) Take torch in left hand, slide the contact tip over the wire and screw back into place.
b) Grasp gas cup in right hand, push onto torch head and turn clockwise only. Do not turn gas cup anti-clockwise, as this will damage the internal spring.
c) Cut wire so that it is just protruding from the cup.

- 3.6. **SETTING WIRE TENSION.** Adjust the wire tension by rotating the wire tension knob. Turn clockwise to increase the tension and anticlockwise to decrease the tension. See fig 9.1.

IMPORTANT: Too little or too much tension will cause problematic wire feed and result in poor welding.

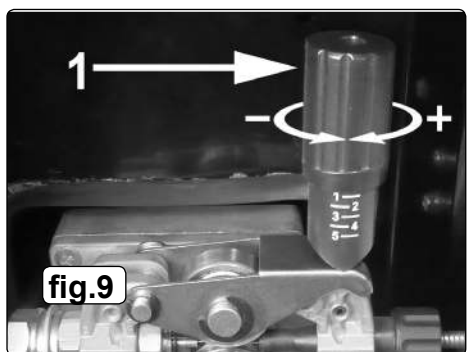
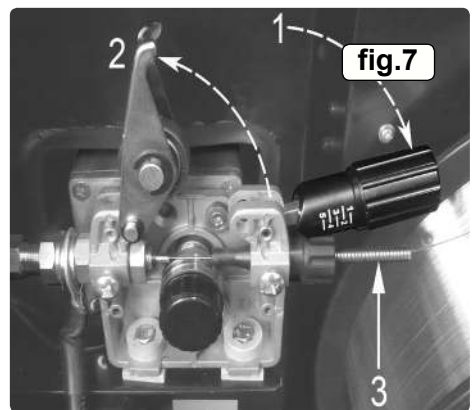
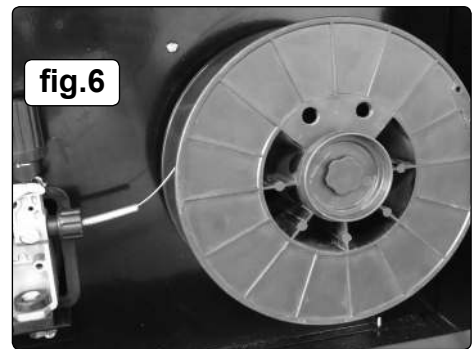
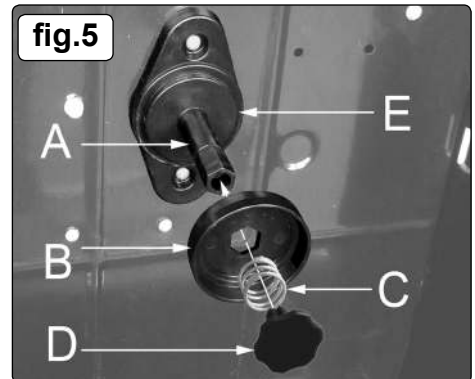

3.6.1 Tension between rollers is checked by slowing down the wire between gloved fingers. If top feed roller skids the tension is correct. Use as low a tension as possible; too high a tension could crush the wire and result in a blown fuse.

3.7. TURNING/CHANGING THE DRIVE ROLLER. (See figs.7 and 10.) Ensure that the wire diameter (0.6/0.8mm) used is matched by the correct groove size in the drive wheel and the correct tip size on the torch as well as the correct torch liner. Failure to do so could cause the wire to slip and/or bind.

- 3.7.1. Referring to fig.7, open the wire feed mechanism by pushing the locking/wire tension knob (1) down to the right allowing the pressure roller carrier (2) to spring up revealing the feed roller.
- 3.7.2. Referring to figure 10, move knob (C) and put to one side.
- 3.7.3. The roller carrier (A) is keyed to the main drive shaft and the drive roller (B) is keyed to the carrier, see below. Place a finger onto the end of the drive shaft to prevent the carrier moving and slide the drive roller off the carrier with your other hand.
- 3.7.4. The size of each wire feed groove is printed on the edge of the roller on the same side as the groove.
- 3.7.5. Turn the roller over to use the other groove or use a roller with different sized grooves as required. The groove to be used should be positioned furthest away from you to be in line with the drive path.

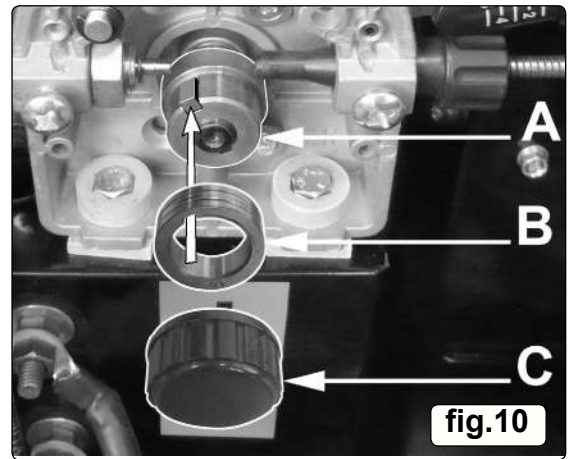

- 3.7.6. Check that the key in the carrier (A) is properly seated in its slot. Ensure that the slot on the inside face of the drive roller (B) is aligned with the key and slide the roller back onto the carrier.
- 3.7.7. Screw the black roller retaining knob (C) back on to the end of the drive shaft and tighten.

3.8. CONVERTING TO GASLESS WELDING. When delivered, your welder is set up for gas welding with the torch cable connected to the positive (+) terminal and the earthing cable connected to the negative (-) terminal. (fig.11)

- 3.8.1. **To weld without gas (using flux cored wire) you must reverse the polarity and connect the torch cable to the negative (-) terminal and the earthing cable to the positive (+) terminal (fig.11). Ensure that the machine is switched off and unplugged from the mains supply before carrying out this task.**
- 3.8.2. Safely disconnect the gas.
- 3.8.3. Fit a 1.0mm tip to the torch.
- 3.8.4. Mount the flux cored wire reel and feed it through to the torch.



4. MIG/MAG WELDING

A spool of welding wire is positioned on the welder's spool holder and automatically fed through an insulated liner in the torch to the tip. The torch assembly consists of a switch, liner, gas hose, and control cable. The switch activates the wire feed roller and the gas flow. Conversely, releasing the switch stops the wire feed and gas flow. The weld current is transferred to the electrode (the wire) from the contact tip at the end of the torch. A gas cup fits over the contact tip to direct the gas flow towards the weld ensuring that the arc welding process is shielded from oxidising air contaminants. The shielding gas also assists heating of the weld materials. (The welder can also be used in gasless mode using flux cored wire). The torch is connected to the positive side of a DC rectifier, and the negative clamp is attached to the workpiece.

IMPORTANT: Should you have no welding experience, we recommend you seek training from an expert source to ensure your personal health & safety. Good MIG welding may be achieved only with continued, supervised practice.

4.1. PREPARATION FOR WELDING

IMPORTANT: BEFORE YOU COMMENCE, MAKE SURE THE MACHINE IS SWITCHED OFF AT THE MAINS. IF WELDING A CAR, DISCONNECT THE BATTERY OR FIT AN ELECTRONIC CIRCUIT PROTECTOR. WE STRONGLY RECOMMEND THE USE OF SEALEY "PROSAF/12V OR 24V" IN ORDER TO PROTECT SOPHISTICATED ELECTRONICS. ENSURE YOU HAVE READ & UNDERSTOOD THE ELECTRICAL SAFETY INSTRUCTIONS IN CHAPTER 1.

4.1.1. Connecting the Earth Lead.

To ensure a complete circuit, the earth lead must be securely attached to the workpiece that is to be welded.

- a) Best connection is obtained by grinding clean the point of contact on the workpiece before connecting the earth clamp.
- b) The weld area must also be free of paint, rust, grease, etc.
- c) When welding a vehicle, be sure the vehicle battery is disconnected or fit an Electronic Circuit Protector available from your Sealey dealer.

4.1.2. **Voltage Switch (fig1.6)** Set the switch to position 1 or 2 for welding up to 2mm thickness. Use settings 3, 4, 5, 6. for thicker welds. The selected voltage is displayed by indicator fig1.7.

4.1.3. **Setting the welder controls.** In principle, the lower the power required, the slower the wire speed. See setting chart for voltage and corresponding wire speeds. Note: these settings are only a guide and will vary according to the operators experience.

4.1.4. Welding mild steel

To weld mild steel you can use CO₂ gas for most tasks where spatter and the high build up of weld do not pose a problem. Welding with a long arc reduces penetration and widens the arc. This in turn results in more spatter. A long welding arc can be appropriate for welding butt joints in thin materials. Welding with a short arc, at the same weld settings, results in greater penetration and a narrower weld and reduces the amount of spatter. To achieve a consistent spatter free and flat weld, you must use an argon/CO₂ mixture.

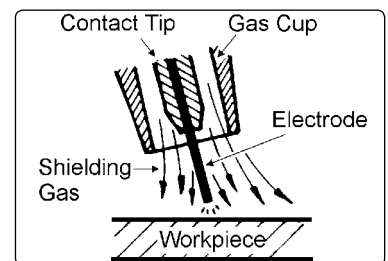

Wire: 0.6mm Steel Argon/CO ₂ Mix						
Voltage Step:	1	2	3	4	5	6
Wire Speed:	5	6	7	8	9	10
Settings shown as Guide Only						

4.1.5. **To weld aluminium use:**

- Argon gas,
- 0.8mm Contact Tip (MIG927),
- 0.8mm Aluminium Wire, (MIG/2KAL08).

A clean torch liner is essential, as any contamination of the aluminium wire will produce a poor weld.

4.1.6. **Overload Protection.** Thermostatic overload protection is provided. When an overload has occurred, leave the unit to cool. The thermostat will automatically reset the unit when the temperature has returned within limits.

4.1.7. **Burn Back Timer.** The INVMIG200 is fitted with a variable Burn Back Timer, the control knob of which is situated inside the case, above the wire feed assembly. The function of this timer is to leave a controlled amount of welding wire protruding after the weld current switches off. This prevents the wire melting onto the electrode.

4.1.8. The interval can be adjusted by moving the knob shown in fig.12.

4.1.9. **Spot Welding.** Spot welding may be carried out as shown in fig.13. It will be necessary to fit a spot welding gas cup. (Sealey part No. 168.200162)

- (a) Overlapping metal sheets with a maximum thickness of 0.8 mm may be welded as indicated.
- (b) Alternatively they may be welded edge to surface as indicated.
- (c) For thicker sheet pre drilled holes holes may be employed.

4.1.10. Use the wire feed control in conjunction with the spot weld timer (fig.1.9). To activate the timer turn the knob clockwise.

4.1.11. **If not being used, the spot weld timer must be set in the OFF position.**

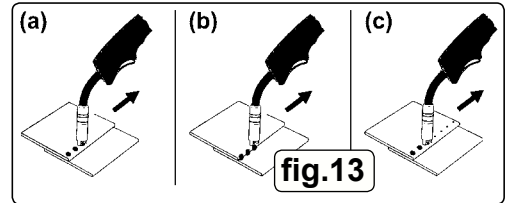

5. MMA (ARC) WELDING

For arc welding the selector switch needs to be in the Arc (left hand) setting. (fig.1.2)

- WARNING! Before using as an arc welder, ensure that the torch connector plug is disconnected from both positive (+) and negative (-) output sockets. (fig.1.11)**
- WARNING! Ensure that the inverter is not plugged into the mains power supply before connecting or disconnecting cables. For electrical installation, see Safety Instructions (Section 1).**
- WARNING! Failure to follow the electrical safety instructions may affect the operating performance and could damage the built-in safety system which, in turn, could result in personal injury or fatality and will invalidate the warranty.**

5.1. WELDING CABLE ELECTRODE HOLDER CONNECTION

NOTE: Arc welding cables are not supplied with machine. Sealey part no: INVMMMA2 is suitable. Before connecting cables it is important to refer to the electrode manufacturer's instructions on the electrode packaging which will indicate the correct polarity connection for the electrode, together with the most suitable current to use.

5.2. ARC WELDING

In principle, when arc welding the electrode holder is normally connected to the "POSITIVE" (+) terminal (fig.1.11).

5.3. WELDING RETURN CABLE- (WORK CLAMP) CONNECTION

The work clamp cable is connected to the terminal not occupied by the electrode holder cable. The clamp is connected to:

- a) The workpiece, or
- b) A metallic work bench. The connection must be as close to the proposed weld as possible.

- WARNING! Cable connectors must be turned fully into the quick plugs to ensure a good electrical contact. Loose connections will cause overheating, rapid deterioration and loss in efficiency. DO NOT use welding cables over 10m in length. With the exception of a metallic workbench DO NOT connect the return cable to any metallic structure which is not part of the workpiece, as this will jeopardise weld quality and may be dangerous.**

6. PREPARATION

- 6.1. The welding current must be regulated according to the diameter of the electrode in use and the type of joint to be welded. See diameter/current chart to the right. Welding current is controlled by the amperage regulator (fig.1.5).
- 6.2. Further consideration must be given to the location of the weld, for example: Welds that are performed on a horizontal surface require a higher voltage than those performed on a vertical or overhead surface.
- 6.3. The mechanical character of the weld will be determined not only by the current used, but also by the diameter and quality of the electrode, the length of the arc and the speed and position of the user. The condition of the electrode is an important factor and it must never be wet or damp.
- 6.4. Ensure that the workpiece is correctly secured before operating the inverter.

Electrode Diameter (mm)	Welding Current (Amps)
Min Max
1.6	25 50
2	40 80
2.5	60 110
3.2	80 160
4	120 200

For Guidance Only

7. WELDING PROCEDURE

- WARNING! Ensure that you read, understand and follow the safety instructions. Place the welding mask in front of your face before striking the arc.**
- 7.1. **ARC WELDING**
 - 7.1.1. Strike the electrode tip on the workpiece as if you were striking a match.
 - WARNING! DO NOT hit the electrode on the workpiece, as this may damage the electrode.**
 - 7.1.2. As soon as the arc is struck, maintain a distance from the workpiece equal to the diameter of the electrode. Keep this distance as constant as possible for the duration of the weld. As you advance along the workpiece the angle of the electrode must be maintained at between 20° and 30°. See fig.13.
 - 7.1.3. At the finish of the weld, bring the end of the electrode backward in order to fill the weld crater and then quickly lift the electrode from the weld pool to extinguish the arc.
- WARNING! Hot metal such as electrode stubs and workpieces should never be handled without gloves.**

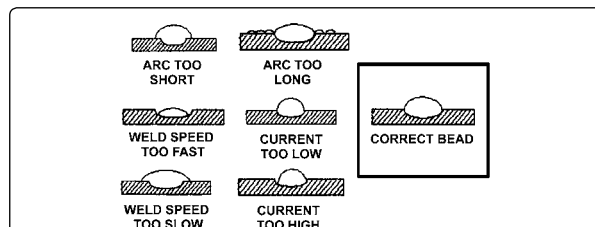
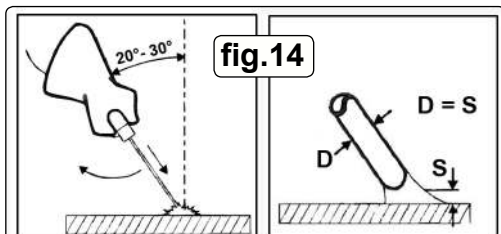

8. TIG WELDING

- 8.1. The selector switch (fig.1.1) should be set to the TIG (middle) position.
 8.2. **NOTE:** The INVMIG200 is not supplied with TIG leads. Sealey part no: INV TIG2 is suitable.
 8.3. **TIG CONNECTIONS.**

TIG TORCH CABLE. Dinse plug at the end of the torch cable will be connected to the **negative socket (-)** on the front panel (see fig.1.11).

WORK CLAMP CABLE. Dinse plug at the end of the clamp cable will be connected to the **positive socket (+)** on front panel
Please note that the way the welding cables are connected to the inverter for ordinary MMA welding may be different from the way the cables are connected for standard TIG welding. Whilst most stick electrodes are connected to the positive terminal certain types need to be connected to the negative terminal. It is therefore essential that the user refers to the manufacturer's instructions for the electrodes to ensure that the correct polarity is selected.

- 8.4. **PREPARATION AND CHOICE OF ELECTRODE.** In order to produce a good weld it is important to choose an electrode of the correct diameter for the current to be used. For a general guide to the settings to be used with particular diameters of electrodes please refer to the tables below. The electrode will normally protrude from the ceramic nozzle by 2 to 3mm but in order to gain access to inaccessible areas such as internal corners the electrode can be made to protrude by up to 8mm. The chosen electrode should be sharpened axially on a grinding wheel as indicated in the diagram to the right. The tip should be perfectly concentric in order to avoid arc deviations. The condition of the electrode should be regularly inspected to maintain it in peak condition.

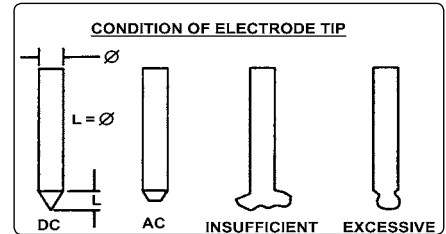

- 8.5. **PREPARATION OF THE WORKPIECE.** For a good weld it is important that the workpiece is cleaned thoroughly so that no oxides, oil, grease or solvents remain on the surface of the material.
 8.6. **TIG WELDING PARAMETERS.**

TIG WELDING PARAMETERS FOR STAINLESS STEEL.

Thickness (mm)	Current (A)	Electrode (diam mm)	Nozzle (diam mm)	Argon (L/min)	Filler Rod (diam mm)
0.5 - 0.8	15 - 30	1	6.5	3	---
1	30 - 60	1	6.5	3 - 4	1
1.5	70 - 100	1.6	9.5	3 - 4	1.5
2	90 - 110	1.6	9.5	4	1.5 - 2.0
2.5	110 - 130	1.6	9.5	5	1.5 - 2.0
3	120 - 150	1.6 - 2.4	9.5	5 - 6	2 - 3

TIG WELDING PARAMETERS FOR DEOXIDISED COPPER.

Thickness (mm)	Current (A)	Electrode (diam mm)	Nozzle (diam mm)	Argon (L/min)	Filler Rod (diam mm)
0.5 - 0.8	20 - 30	1	6.5	4	---
1	80 - 100	1.6	9.5	6	1.5
1.5	110 - 140	1.6	9.5	6	1.5

9. RATINGS PLATE

The ratings plate on the inverter gives the following data:

- Rating of internal protection provided by casing.
- Symbol for power supply line: 1= Single-phase AC.
- Symbol for internal structure of the welding machine.
- Manufacturers Details and Model No.
- Manufacturers Serial Number for welding machine identification.
- MMA Output.
- MIG Output
- TIG Output
- U_0 : Maximum no load voltage.
 I_2, U_2 : Current and corresponding normalised voltage that the welding machine can supply during welding.
 X: Welding ratio based on a 10 minute duty cycle. 30% indicates 3 minutes welding and 7 minutes rest, 100% indicates continuous welding.
 A/V-A/V: Shows the range of adjustment for the welding current (minimum - maximum) at the corresponding arc voltage.
- Power Supply
 U_1 : Alternating voltage and power supply frequency of welding machine (allowed limit $\pm 10\%$)
 I_{1max} : Maximum current absorbed by the line.
 I_{1eff} : Effective current supplied.
- The EUROPEAN standard relating to the safety and construction of arc welding machines.

		10A/20.4V~170A/26.8V		
		X	60%	100%
MMA	I_2	170A	100A	75A
	U_2	26.8V	24V	23V
MIG	I_2	200A	115A	90A
	U_2	18V	14.8V	13.6V
TIG	I_2	200A	115A	90A
	U_2	24V	19.75V	18.5V

COOLING METHOD: FAN COOLING | DEGREE OF PROTECTION: IP21S | INSULATION GRADE: F

10. DUTY CYCLE

When the machine reaches the end of its duty cycle and overheats, the thermostatic switch opens to allow the internal components to cool. This is denoted by the yellow LED (fig 1.3) illuminating. Allow the machine to cool and resume use when the light goes out.

11. MAINTENANCE

- WIRE FEED UNIT** Check the wire feed unit at regular intervals. The feed roller wire guide plays an important part in obtaining consistent results. Poor wire feed affects welding. Clean the rollers weekly, especially the feed roller groove, removing all dust deposits.
- TORCH** Protect the torch cable assembly from mechanical wear. Clean the liner from the machine forwards by using compressed air. If the liner is clogged it must be replaced.
- CHANGING FEED ROLLER** (See Section 3.7)
- CONTACT TIP** The contact tip is a consumable item and must be replaced when the hole becomes enlarged or oval. The contact tip **MUST** be kept free from spatter to ensure an unimpeded flow of gas. Refer to fig.8 and section 3.5.4 for removal and replacement.
- GAS CUP** The gas cup must also be kept clean and free from spatter. Build up of spatter inside the gas cup can cause a short circuit at the contact tip which will result in either the fuse blowing on the printed circuit card, or expensive machine repairs. To keep the contact tip free from spatter, we recommend the use of Sealey anti-spatter spray (MIG/722308) available from your Sealey Dealer. Refer to fig.8 and section 3.5.4 for removal and replacement.

- 11.6. **REPLACING THE LINER** Wind the wire back on to the spool and secure it. Unscrew the torch from the machine and undo the brass nut. The liner should now be visible. Pull it out and replace with a new one.
- 11.7. Remove the casing periodically and, with a low pressure air flow (max 1bar or 15psi), remove dust from inside the machine.
- 11.8. Do not direct compressed air onto the electronic circuit boards, these should be cleaned with a very soft brush.
- 11.9. Ensure that all electrical connections are tight and check the wiring for damage to the insulation.
- 11.10. Ensure that the casing is correctly replaced and secured before attempting to use the inverter.
- 11.11. Keep the outside of the machine clean by wiping with a soft, dry cloth.

For any other service or maintenance, contact your local Sealey service agent.

12. ELECTROMAGNETIC COMPATIBILITY

- 12.1. THIS EQUIPMENT IS IN CONFORMITY WITH THE EUROPEAN STANDARD ON THE ELECTROMAGNETIC COMPATIBILITY OF ARC WELDING EQUIPMENT AND SIMILAR PROCESSES (e.g. ARC AND PLASMA CUTTING)
- 12.2. **Protection against interference. (E.M.C.)** The emission limits in this standard may not, however, provide full protection against interference to radio and television reception when the equipment is used closer than 30m to the receiving antenna. In special cases, when highly susceptible apparatus is being used in close proximity, additional mitigation measures may have to be employed in order to reduce the electromagnetic emissions. At the same time there could occur some potential difficulties in having electromagnetic compatibility in a non-industrial environment (e.g. in residential areas). Therefore it is most important that the equipment is used and installed according to the following instructions.
- 12.3. **Installation and use.** The user is responsible for installing and using the equipment according to these instructions. If electromagnetic disturbances are detected, then it shall be the responsibility of the user of the equipment to resolve the situation with the technical assistance of the supplier. In some cases this remedial action may be as simple as earthing the circuit (see Note). In other cases it could involve constructing an electromagnetic screen, enclosing the welding power source and the work, complete with associated input filters. In all cases the electromagnetic disturbances shall be reduced to the point where they are no longer troublesome.
Note: The welding/cutting circuit may or may not be earthed for safety reasons. Changing the earthing arrangements should only be authorised by a person who is competent to assess whether the changes will increase the risk of injury, e.g. by allowing parallel welding/cutting circuit return paths which may damage the earth circuits of other equipment. Further guidance is given in IEC 974-13 'Arc Welding Equipment - Installation and Use.'
- 12.4. **Assessment of area.** Before installing the equipment the user shall make an assessment of potential electromechanical problems in the surrounding area. The size of the surrounding area to be considered will depend on the structure of the building and other activities that are taking place. The surrounding area may extend beyond the boundaries of the premises.
The following shall be taken into account :
 - a) Other supply cables, control cables, signalling and telephone cables, above, below and adjacent to the welding equipment.
 - b) Radio and television transmitters and receivers.
 - c) Computer and other control equipment.
 - d) Safety critical equipment, e.g. security monitoring of industrial equipment.
 - e) The health of people in the vicinity, e.g. persons fitted with a pacemaker or hearing aid.
 - f) Equipment used for calibration or measurement.
 - g) The immunity of other equipment in the environment. The user shall ensure that other equipment being used in the environment is compatible. This may require additional protective measures.
 - h) The time of day that welding and other activities are to be carried out.
- 12.5. **Mains supply.** The equipment should be connected to the mains supply according to these instructions. If interference occurs, it may be necessary to take additional precautions such as filtering of the mains supply. Consideration should also be given to shielding the supply cable of permanently installed equipment in metallic conduit or equivalent. This shielding should be connected to the power source so that good electrical contact is maintained between the conduit and the welding power source enclosure.
- 12.6. **Maintenance of the equipment.** The equipment should be routinely maintained according to these instructions. All access and service covers should be closed and properly fastened when the welding equipment is in operation. The welding equipment should not be modified in any way except for those changes and adjustments covered in these instructions. In particular, the spark gaps of any arc striking and stabilising devices should be adjusted and maintained according to the instructions.
- 12.7. **Cables.** The welding/cutting cables should be kept as short as possible and should be positioned close together, running at or close to the floor level.
- 12.8. **Equipotential bonding.** Bonding of all metallic components in the welding/cutting installation and adjacent to it should be considered. However, metallic components bonded to the workpiece will increase the risk that the operator could receive a shock by touching these metallic components and the electrode at the same time. The operator should be insulated from all such bonded metallic components.
- 12.9. **Earthing of the workpiece.** Where the workpiece is not bonded to earth for electrical safety, nor connected to earth because of its size and position, e.g. ship's hull or building steelwork, a connection bonding the workpiece to earth may reduce emissions in some, but not all instances. Care should be taken to prevent the earthing of the workpiece increasing the risk of injury to others or damage to other electrical equipment. Where necessary, the connection of the workpiece to earth should be made by a direct connection to the workpiece, but in some countries where direct connection is not permitted, the bonding should be achieved by a suitable capacitance, selected according to national regulations.
- 12.10. Selective screening and shielding of other cables and equipment in the surrounding area may alleviate problems of interference. Screening of the entire welding/cutting installation may be considered for special applications.

Parts support is available for this product. To obtain a parts listing and/or diagram, please log on to:
www.sealey.co.uk, email: sales@sealey.co.uk or phone:01284 757500.



Environmental Protection.

Recycle unwanted materials instead of disposing of them as waste. All tools, accessories and packaging should be sorted, taken to a recycle centre and disposed of in a manner which is compatible with the environment.

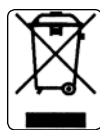

WEEE Regulations.

Dispose of this product at the end of its working life in compliance with the EU Directive on Waste Electrical and Electronic Equipment. When the product is no longer required, it must be disposed of in an environmentally protective way. Contact your local solid waste authority for recycling information.

NOTE: It is our policy to continually improve products and as such we reserve the right to alter data, specifications and component parts without prior notice.

IMPORTANT: No liability is accepted for incorrect use of this product.

WARRANTY: Guarantee is 12 months from purchase date, proof of which will be required for any claim.

INFORMATION: For a copy of our latest catalogue and promotions call us on 01284 757525 and leave your full name and address, including postcode.



Sole UK Distributor, Sealey Group,
Kempson Way, Suffolk Business Park,
Bury St. Edmunds, Suffolk,
IP32 7AR



01284 757500



www.sealey.co.uk



01284 703534



sales@sealey.co.uk