

SENA

English

105 Motorcycle Bluetooth® Communication System

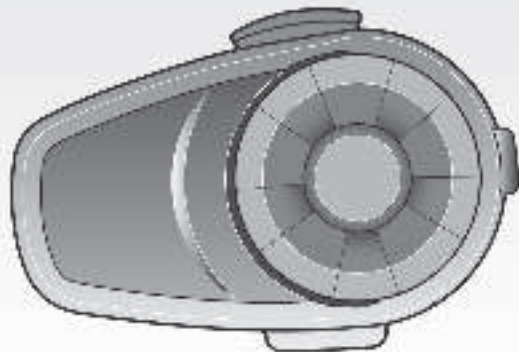

The firmware version 3.0.x indicates that this manual is applicable to all firmware updates within the version 3.0 series.

**WARNING**

To minimize the risk of serious injury, death or product damage, read this User's Guide and the Quick Start Guide before using the product for the first time. Go to sena.com to access these documents if they are missing or unreadable. Keep both Guides for future reference.

© 1998–2025 Sena Technologies, Inc. All rights reserved.

Sena Technologies, Inc. reserves the right to make any changes and improvements to its product without providing prior notice.

Sena™ is a trademark of Sena Technologies, Inc. or its subsidiaries in the USA and other countries. SF1™, SF2™, SF4™, SFR™, SRL™, SRL2™, SRL3™, SRL-EXT™, SRL-Mesh™, Momentum™, Momentum INC™, Momentum Lite™, Momentum Pro™, Momentum INC Pro™, Momentum EVO™, Cavalry™, CAVALRY 2™, Latitude SR™, Latitude SX™, Latitude S1™, 30K™, 33i™, 60S™, 50S™, 50R™, 50C™, 5S™, 5R™, 5R LITE™, 20S EVO™, 20S™, 10S™, 10C™, 10C PRO™, ProRide EVO™, 10C EVO™, 10U™, 10Upad™, 10R™, ACS10™, ACS-RAM™, BiKom 20™, B10™, B20™, E30™, J30™, C1™, C10™, C20™, CAST™, 3S™, 3S PLUS™, SMH5™, SMH5-FM™, SMH5 MultiCom™, SMH10™, SMH10R™, SPH10™, SPH10H-FM™, Savage™, Prism Tube WiFi™, Prism™, Bluetooth Audio Pack for GoPro®, IMPULSE™, FURY™, R1™, R1 EVO™, R1 EVO CS™, R2™, R2 EVO™, R2X™, M1™, M1 EVO™, S1™, RUMBA™, RC1™, RC3™, RC4™, STRYKER™, Handlebar Remote™, Wristband Remote™, PHANTOM™, PowerPro Mount™, Powerbank™, FreeWire™, WiFi Docking Station™, WiFi Sync Cable™, WiFi Adapter™, +mesh™, +Mesh Universal™, MeshPort Blue™, MeshPort Red™, MeshPort Black™, Econo™, OUTLANDER M™, OUTRUSH™, OUTRUSH R™, OUTSTAR™, OUTSTAR S™, OUTFORCE™, OUTRIDE™, OUTRUSH M™, EcoCom™, Parani A10™, Parani A20™, Parani M10™, pi™, Snowtalk™, Snowtalk2™, SR10™, SR10i™, SM10™, SPIDER RT1™, SPIDER ST1™, SURGE™, TALKIE™, U1™, X1™, X1 Pro™, X1S™, EXPAND™, EXPAND BOOM™, EXPAND MESH™, Bluetooth Mic & Intercom™, Tufftalk™, Tufftalk Lite™, Tufftalk M™, NAUTITALK Bosun™, NAUTITALK N2R™ are trademarks of Sena Technologies, Inc. or its subsidiaries. These trademarks may not be used without the express permission of Sena.

GoPro® is a registered trademark of Woodman Labs of San Mateo, California. Sena Technologies, Inc. (“Sena”) is not affiliated with Woodman Labs, Inc. The Sena Bluetooth Pack for GoPro® is an aftermarket accessory specially designed and manufactured by Sena Technologies, Inc. for the GoPro® Hero3 and Hero4 allowing for Bluetooth capabilities.

The Bluetooth® word mark and logos are owned by the Bluetooth SIG, Inc. and any use of such marks by Sena is under license. iPhone, iPod touch are registered trademarks of Apple Inc. Zumo™ is a trademark of Garmin Ltd. or its subsidiaries. TomTom™ is the trademark or registered trademark owned by TomTom International B.V. Other trademarks and tradenames are those of their respective owners.

CONTENTS

1	INTRODUCTION	4
2	PACKAGE CONTENTS	5
3	INSTALLING THE 10S ON YOUR HELMET	7
3.1	Installing the Main Unit.....	7
3.2	Installing the Speakers.....	9
3.3	Installing the Microphones.....	10
4	GETTING STARTED	13
4.1	Button Operation.....	13
4.2	Powering On and Off.....	13
4.3	Charging.....	13
4.4	Low Battery Warning.....	14
4.5	Checking the Battery Level.....	14
4.6	Volume Adjustment.....	15
4.7	Sena Softwares.....	15
5	PAIRING THE 10S WITH BLUETOOTH DEVICES	16
5.1	Phone Pairing.....	16
5.2	Second Mobile Phone Pairing.....	16
5.3	Intercom Pairing.....	17
6	MOBILE PHONE, GPS	19
6.1	Mobile Phone Call Making and Answering.....	19
6.2	Speed Dialing.....	19
6.3	GPS Navigation.....	20
7	STEREO MUSIC	21
7.1	By Bluetooth Wireless Stereo.....	21
7.2	Music Sharing.....	22
8	INTERCOM	22
8.1	Two-way Intercom.....	22
8.2	Three-way Intercom.....	23
8.3	Four-way Intercom.....	25
9	THREE-WAY CONFERENCE PHONE CALL WITH INTERCOM PARTICIPANT	26
10	GROUP INTERCOM	27
11	UNIVERSAL INTERCOM	28
11.1	Universal Intercom Pairing.....	29
11.2	Two-way Universal Intercom.....	29
11.3	Three-way Universal Intercom.....	30
11.4	Four-way Universal Intercom.....	31
12	FUNCTION PRIORITY	33
13	CONFIGURATION SETTING	33
13.1	Headset Configuration Setting.....	33
13.2	Software Configuration Setting.....	34
14	REMOTE CONTROL	37
14.1	Pairing with the Handlebar Remote.....	37
14.2	Using the Handlebar Remote.....	37
15	FIRMWARE UPGRADE	38
16	TROUBLESHOOTING	39
16.1	Intercom Failure.....	39
16.2	Intercom Reconnection.....	39
16.3	Fault Reset.....	39
16.4	Factory Reset.....	40

1 INTRODUCTION

Thank you for choosing the Sena 10S, Motorcycle Bluetooth Communication System. With the 10S, you can call hands-free on your Bluetooth mobile phone, listen to stereo music or voice instructions of GPS navigations wirelessly, and have intercom conversations in full duplex with a passenger or other motorcycle riders.

Please read this User's Guide carefully before using the headset. Also check www.sena.com for the latest version of the User's Guide and additional information related to Sena Bluetooth products.

The 10S features:

- Bluetooth 5
- Multi-way intercom up to 4 connections
- Intercom range: 1.0 mi (1.6 km)*
- Smartphone App for iPhone and Android
- Universal Intercom™
- Music Sharing
- Intuitive voice prompts
- Advanced Noise Control™
- Easy operation by versatile Jog Dial
- Can be used while charging on road trips
- Water resistant for use in inclement weather
- Optional Handlebar Remote support (not included)
- Firmware upgradeable

.....
* in open terrain

2 PACKAGE CONTENTS

- **Headset Main Unit**



- **Clamp Unit**

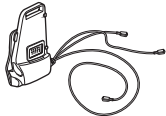

- **Glued Surface Mounting Adapter**



Speaker

- **Speakers (2)**



- **Hook and Loop Fasteners for Speakers (4)**



- **Speaker Pads (Thick) (2)**



- **Speaker Pads (Thin) (2)**



Wired Microphone

- **Wired Microphone**



- **Hook and Loop Fastener for Wired Microphone**



Wired Boom Microphone

- **Wired Boom Microphone**



- **Hook and Loop Fastener for Wired Microphone**



- **Microphone Sponges (2)**



- **Boom Microphone Holder**



- **Hook and Loop Fastener for Boom Microphone Holder**



Others

- **USB Power & Data Cable**

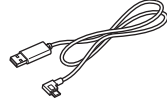

- **Allen Wrench**



3 INSTALLING THE 10S ON YOUR HELMET

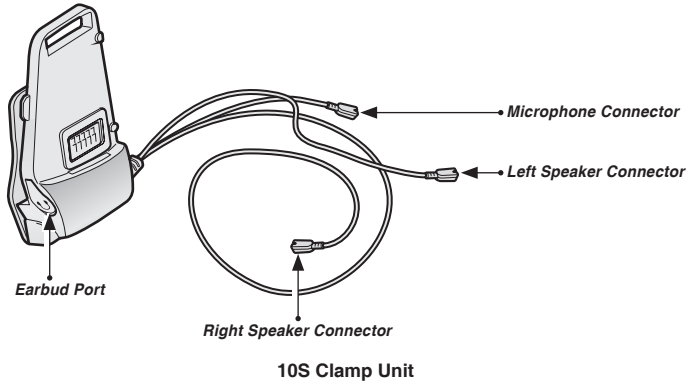

3.1 Installing the Main Unit

3.1.1 Using the Clamp Unit

1. Loosen the two screws on the back plate of the clamp unit with the included allen wrench.

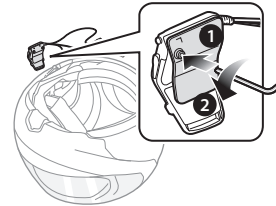

2. Insert the back plate of the clamp unit between the internal padding and external shell of the left side of the helmet.

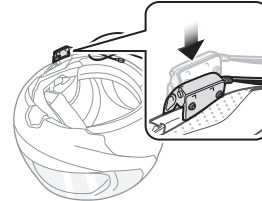

3. Tighten the two screws until the clamp unit is fastened firmly to the helmet.

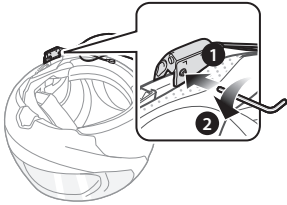

4. Attach the main unit to the clamp unit until you hear a click. The main unit is now fastened to the clamp unit.

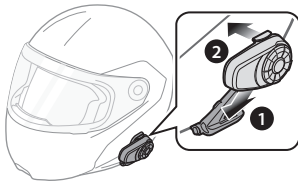

3.1.2 Using the Glued Surface Mounting Adapter

If you cannot install the clamp unit on the helmet, you can use the glued surface mounting adapter to attach the clamp unit to the surface of the helmet.

1. Clean the area on the left side of the helmet where you will attach the glued surface mounting adapter with a moistened towel and dry thoroughly.
2. Peel off the cover of adhesive tape of the glued surface mounting adapter and attach it to the helmet.

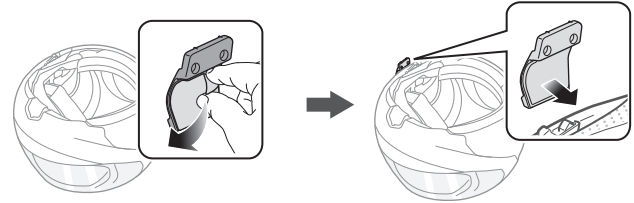

3. Make sure that the glued surface mounting plate sticks on the helmet firmly. Maximum adhesion occurs after 24 hours.
4. Attach the clamp unit on the glued surface mounting adapter using two screws.

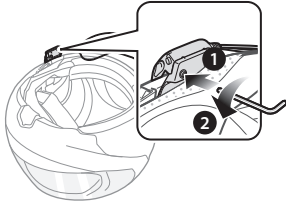
**CAUTION:**

Sena recommends using the clamp unit. The glued surface mounting adapter is provided for convenience, but is not the recommended mounting method. Sena is not responsible for its use.

5. Attach the main unit to the glued surface mounting adapter until you hear a click. The main unit is now fastened to the clamp unit.

3.2 Installing the Speakers

1. Peel off each cover of the hook and loop fasteners for speakers to expose the adhesive surface. Then, attach the fasteners to the ear pockets inside the helmet.

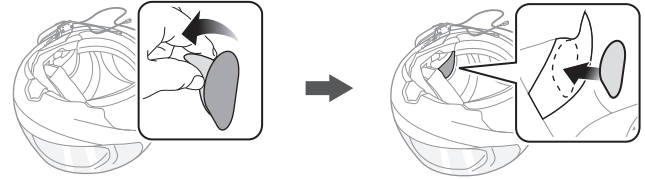

2. Attach the speakers to the hook and loop fasteners for speakers inside the helmet.

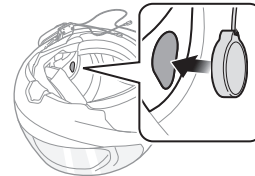

- Align the arrows on the clamp unit and speaker cables and insert speaker cables into each speaker connector.

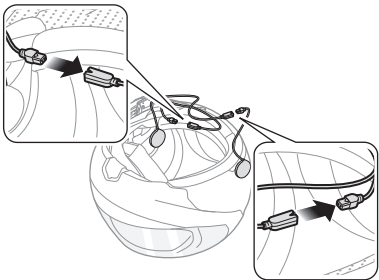

Note:

- Three cables connect to the clamp unit. The longest is the cable for the right speaker. The second longest cable is for the left speaker. The shortest cable is for the microphone.
- If the helmet has deep ear pockets, you can use the speaker pads to bring the speakers closer to your ears.

3.3 Installing the Microphones

3.3.1 Using the Wired Boom Microphone

- Peel off the cover of the hook and loop fastener for wired boom microphone to expose the adhesive tape. Then, attach the hook and loop fastener on the inside surface of the left external shell.

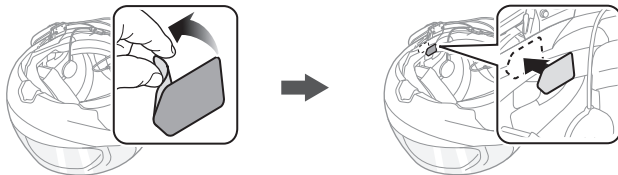

2. Attach the wired boom microphone's mounting plate to the hook and loop fastener.

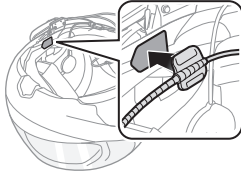

Note:

1. After you install the wired boom microphone, make sure you reinstall the helmet's internal padding.
2. You can use the boom microphone holder after attaching the hook and loop fastener for boom microphone holder on it to ensure secure installation.

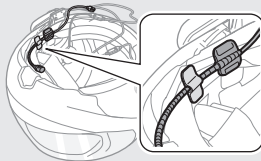

3. Make sure that the microphone's receiver is located near your mouth.

4. Adjust the head of the microphone so that the tab is facing away from your mouth.

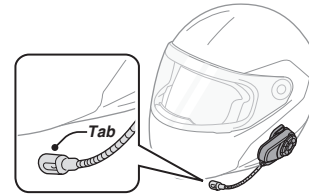

5. Align the arrows on the clamp unit and microphone cables and insert the microphone cable into the microphone connector.

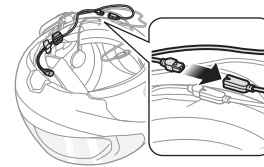

Note:

Three cables connect to the main unit. The longest is the cable for the right speaker. The second longest cable is for the left speaker. The shortest cable is for the microphone.

3.3.2 Using the Wired Microphone

If you have a full face helmet, you can use the wired microphone.

1. Peel off the cover of the hook and loop fastener for wired microphone to expose the adhesive tape. Then, attach the hook and loop fastener on the inside of the helmet's chin guard.

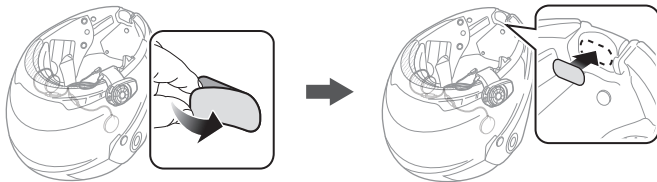

2. Attach the wired microphone to the hook and loop fastener for wired microphone.

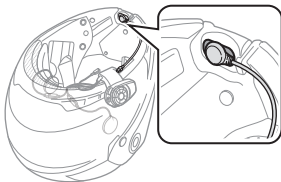

3. Align the arrows on the clamp unit and microphone cables and insert the microphone cable into the microphone connector.

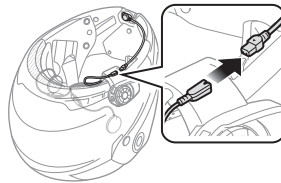

Note:

1. After connecting all cables, store any excess cables behind the internal padding of helmet to prevent wires from becoming damaged.
2. Three cables connect to the main unit. The longest is the cable for the right speaker. The second longest cable is for the left speaker. The shortest cable is for the microphone.

CAUTION:

When you remove the headset, make sure that you first detach all cables from the clamp unit. Then it is safe to remove the main unit and clamp unit in order.

4 GETTING STARTED

4.1 Button Operation

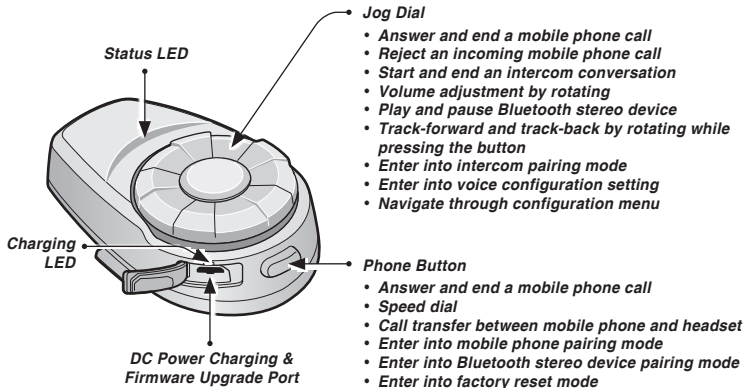

10S Headset Buttons

4.2 Powering On and Off

To power on the headset, press the Phone Button and the Jog Dial at the same time while hearing ascending beeps and a voice prompt, “Hello.” To power off the headset, press the Phone Button and the Jog Dial at the same time while hearing descending beeps and a voice prompt, “Goodbye.”

4.3 Charging



WARNING

When charging the battery, use only the approved charger provided by the manufacturer. Use of a non-approved charger may cause fire, explosion, leakage, and other hazards which may also reduce the life time or performance of the battery.

You can charge the headset by connecting the supplied USB power & data cable into a computer's USB port or USB wall charger. The charging LED turns red while charging and turns blue when fully charged. It takes about 2.5 hours to be completely charged.

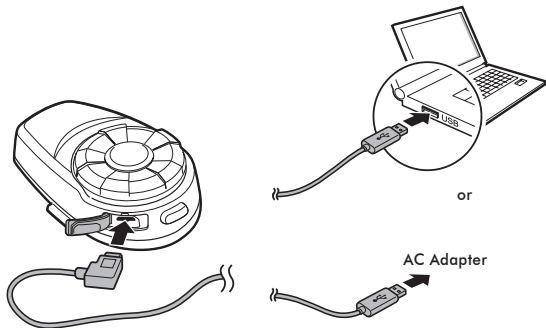
**Note:**

Any 3rd party USB charger can be used with Sena products if the charger is approved by either the FCC, CE, or IC.

4.4 Low Battery Warning

When the battery is low, the blinking blue LED in stand-by mode turns to red and you will hear mid-toned triple beeps and a voice prompt, “Low battery.”

4.5 Checking the Battery Level

4.5.1 LED Indicator

When the headset is powering on, the red LED flashes rapidly indicating the battery level.

4 flashes = High, 70 ~ 100%

3 flashes = Medium, 30 ~ 70%

2 flashes = Low, 0 ~ 30%

Note:

1. The battery performance may be reduced over time with usage.
2. Battery life may vary depending on conditions, environmental factors, functions of the product in use, and devices used with it.

4.6 Volume Adjustment

You can easily adjust the volume by rotating the Jog Dial. You will hear a beep when the volume reaches the maximum or minimum level. The volume is set and maintained independently at different levels for each audio source even when you reboot the headset. For example, once you set the volume for mobile phone hands-free, it will not change even if you adjust the volume for your Bluetooth MP3 music. However, if you adjust the volume during stand-by mode, it will affect volume levels of every audio source.



WARNING

Use of the product at a high volume for a long period of time may damage your eardrums or hearing ability. Keep the volume at a modest level to prevent damage.

4.7 Sena Softwares

4.7.1 Sena Device Manager

The **Sena Device Manager** allows you to upgrade the firmware and configure its settings directly from your PC or Apple computer. Download the **Sena Device Manager** from sena.com.

4.7.2 Sena Motorcycles App

By simply pairing your phone with your headset, you can use the **Sena Motorcycles App** for quicker and easier set up and management.

- Download
 - Android: Google Play Store > **Sena Motorcycles**
 - iOS: App Store > **Sena Motorcycles**

5 PAIRING THE 10S WITH BLUETOOTH DEVICES

Before using the 10S Bluetooth headset with any other Bluetooth devices for the first time, you will need to pair them together. You can pair the 10S with Bluetooth mobile phones, Bluetooth stereo devices such as MP3 players, or motorcycle specific Bluetooth GPS navigation, and with other Sena Bluetooth headsets. The pairing operation is required only once for each Bluetooth device. The headset remains paired with the devices and automatically reconnects to them when they are within range. You will hear a high-toned single beep and a voice prompt whenever the headset reconnects to the paired device: **“Phone connected”** to a mobile phone, **“Media connected”** to a Bluetooth stereo device.

5.1 Phone Pairing

1. Press and hold the Phone Button for 5 seconds until you hear a voice prompt, **“Phone pairing.”**
2. Search for Bluetooth devices on your smartphone. Select the 10S in the list of devices detected on your phone.

Note:

When you turn on the 10S for the first time or reboot it after a factory reset, the 10S will automatically enter phone pairing mode.

5.2 Second Mobile Phone Pairing

1. To pair the second mobile phone, press and hold the Jog Dial for 5 seconds until the red LED flashes rapidly and you hear a voice prompt, **“Intercom pairing.”**
2. Within 2 seconds, tap the Phone Button again, then the LED flashes blue rapidly and you will hear a voice prompt, **“Second mobile phone pairing.”**
3. Search for Bluetooth devices on your mobile phone. Select the Sena 10S in the list of the devices detected on the mobile phone.
4. Enter 0000 for the PIN. Some mobile phones may not ask for the PIN.
5. The mobile phone confirms that the pairing has completed and the 10S is ready to use. You will hear a voice prompt, **“Your headset is paired.”**

5.3 Intercom Pairing

Up to three other people can be paired with the headset for Bluetooth intercom conversations.

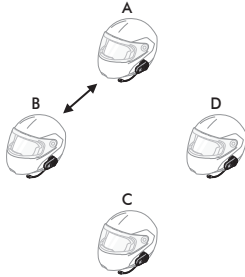



Pairing A & B

5.3.1 Using the Smart Intercom Pairing (SIP)

SIP allows you to quickly pair with your friends for intercom communication by scanning the QR code on the Sena Motorcycles App without remembering the button operation.

1. Pair the mobile phone with the headset.
2. Open the Sena Motorcycles App and tap  (**Smart Intercom Pairing Menu**).

3. Scan the **QR code** displayed on your friend (B)'s mobile phone.
 - Your friend (B) can display the QR code on the mobile phone by tapping  > **QR code** () on the Sena Motorcycles App.



4. Tap **Save** and check that your friend (B) is paired with you (A) correctly.
5. Tap **Scan** () and repeat steps 3-4 to pair with Intercom Friends (C) and (D).

Note:

The **Smart Intercom Pairing (SIP)** is not compatible with Sena products that use **Bluetooth 3.0 or below**.

5.3.2 Using the Button

The 10S can be paired with up to three other headsets for Bluetooth intercom conversation.

1. Turn on the two 10S headsets (A and B) that you would like to pair with each other.
2. Press and hold the Jog Dial of the headset A and B for 5 seconds until red LEDs of the both units start to flash rapidly. You will hear a voice prompt, “**Intercom pairing.**”
3. Tap the Jog Dial on any one of the two headsets A and B, and wait until the LEDs of both headsets turn to blue and intercom connection is automatically established. The two 10S headsets A and B are paired with each other for intercom conversation. If the pairing process is not completed within one minute, the 10S will return to stand-by mode.
4. You can make other pairing between headsets A and C, and between headsets A and D by following the same procedure as above.
5. The intercom pairing queue is ‘**Last-Come, First-Served**’. If a headset has multiple paired headsets for intercom conversations, the last paired headset is set as **first intercom friend**. The previous intercom friend becomes **second intercom friend**, and **third intercom friend**.

Note:

*For example, after the pairing procedures listed above, headset D is the **first intercom friend** of headset A. Headset C is the **second intercom friend** of headset A, and headset B is the **third intercom friend** of headset A.*

6 MOBILE PHONE, GPS

6.1 Mobile Phone Call Making and Answering

1. When you have an incoming call, simply tap the Phone Button or the Jog Dial to answer the call.
2. You can also answer the incoming call by loudly speaking any word of your choice if Voice Activated Phone Answering (VOX Phone) is enabled, unless you are connected to intercom.
3. To end a call, tap the Phone Button or press the Jog Dial for 2 seconds until you hear a mid-toned single beep, or wait for the called person to end the call.
4. To reject a call, press the Jog Dial for 2 seconds until you hear a beep while the phone is ringing.
5. There are several ways to make a phone call:
 - Enter numbers on your mobile phone's keypad and make a call. Then the call is automatically transferred to the headset.
 - Tap the Phone Button in stand-by mode to activate the voice dialer of your mobile phone. For this, the voice dialing function must be available on the mobile phone. Refer to *your mobile phone manual* for further instruction.

Note:

1. If you have two phones connected to your headset and you have an incoming call from the second phone during the call of the first phone, then you may still receive the call from the second phone. In this case, the call from the first phone is on waiting mode. If you end a call, then it will automatically guide you to the first phone call.
2. If you have a mobile phone and a GPS connected to your headset, you may not be able to listen to the GPS voice instruction during the phone call.

6.2 Speed Dialing

You can quickly make a phone call by using the voice speed dial menu.

1. To enter into the voice speed dial menu, double tap the Phone Button and you will hear a mid-toned single beep and a voice prompt, “**Speed dial.**”
2. Rotate the Jog Dial clockwise or counter-clockwise to navigate between the menus. You will hear voice prompts for each menu item.

3. Tap the Phone Button or the Jog Dial to select a voice menu among the followings:

- | | |
|-------------------------------|-------------------------|
| (1) Last number redial | (4) Speed dial 3 |
| (2) Speed dial 1 | (5) Cancel |
| (3) Speed dial 2 | |

4. After selecting the last number redial menu, you will hear a voice prompt, “**Last number redial.**” Then, to redial the last phone call number, tap the Phone Button or the Jog Dial.
5. To call one of the speed dials, rotate the Jog Dial clockwise or counter-clockwise to navigate between the menus until you hear a voice prompt, “**Speed dial (#).**” Then, tap the Phone Button or the Jog Dial.
6. If you want to exit the speed dial immediately, rotate the Jog Dial until you hear a voice prompt, “**Cancel**”, and tap the Phone Button or the Jog Dial. If you do not press any button within 15 seconds, the 10S will exit the voice speed dial menu and go back to stand-by mode.

Note:

1. Make sure that you connect the mobile phone and the headset to use the speed dial function.
2. You need to assign speed dial numbers before using the speed dial (please refer to section 13.2.1, “Speed Dial”).

6.3 GPS Navigation

6.3.1 GPS Pairing

1. Press and hold the Jog Dial for 5 seconds until you will hear a voice prompt saying “**Intercom pairing.**”
2. Within 2 seconds, double tap the Phone Button and you will hear the voice prompt saying “**GPS pairing.**”
3. Search for Bluetooth devices on the GPS navigation. Select the Sena 10S in the list of the devices detected on the GPS.
4. Enter 0000 for the PIN.

Note:

When Audio Multitasking is enabled, if you pair your GPS device via GPS Pairing, its instructions will not interrupt your intercom conversations, but will overlay with them.

7 STEREO MUSIC

7.1 By Bluetooth Wireless Stereo

The Bluetooth audio device must be paired with the 10S by following the *section 5.1, "Phone Pairing"* procedure. The 10S supports the Audio/Video Remote Control Profile (AVRCP), so if your Bluetooth audio device also supports the AVRCP, you can use the 10S to remotely control music playback. Not only can you adjust the volume but you can also use functions such as play, pause, next track and previous track.

1. To play or pause music, press and hold the Jog Dial for 1 second until you hear a double beep.

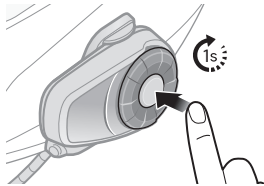

2. To adjust the volume, rotate the Jog dial.

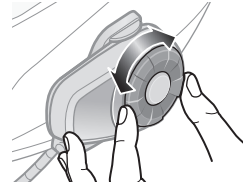

3. To track forward or track back, rotate while pressing the Jog Dial clockwise or counter clockwise.

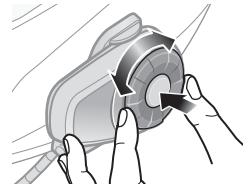

7.2 Music Sharing

You can start sharing music with an intercom friend using Bluetooth stereo music during a two-way intercom conversation (please refer to *section 8.1, "Two-way Intercom"*). When you terminate music sharing, you can go back to the intercom conversation. To start or terminate sharing music, press the Jog Dial for 1 second during an intercom conversation until you hear a double beep. To track forward or track back, rotate while pressing the Jog Dial clockwise or counter-clockwise.

Note:

1. Both you and your intercom friend can remotely control music playback such as track forward and track back.
2. Music sharing will be paused when you are using your mobile phone or listening to GPS instructions.
3. When Audio Multitasking is enabled, if an intercom call is made when you are listening to music, music sharing will not work.

8 INTERCOM

Please make sure your intercom devices are paired as described in *section 5.3, "Intercom Pairing."*

8.1 Two-way Intercom

8.1.1 Starting Two-way Intercom

You can start an intercom conversation with one of any intercom friends by tapping the Jog Dial. Tap the Jog Dial once to intercom with the **first intercom friend**, tap the Jog Dial twice to intercom with the **second intercom friend**, and tap the Jog Dial three times to intercom with the **third intercom friend**.

8.1.2 Ending Two-way Intercom

You can end an intercom conversation by using the Jog Dial. Press and hold the Jog Dial for 1 second to end any intercom. Or, you can single tap to end intercom with the **first intercom friend**, double tap to end intercom with the **second intercom friend**, and triple tap to end intercom with the **third intercom friend**.



8.2 Three-way Intercom

8.2.1 Starting Three-way Intercom

You (A) can have a three-way conference intercom with two other 10S friends (B & C) by establishing two intercom connections simultaneously. While a three-way conference intercom is in progress, mobile phone connection of all three participants is temporarily disconnected. However, as soon as the conference intercom terminates or one of the participants leaves the intercom, all mobile phones automatically reconnect to their headsets. If you have an incoming mobile phone call during the conference intercom, terminate the conference intercom to automatically reconnect and receive the phone call.

1. You (A) need to be paired with two other friends (B & C) for three-way conference intercom.

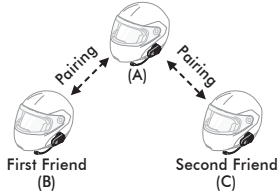

2. Start an intercom conversation with one of the two friends in your intercom group. For example, you (A) may start an intercom conversation with the intercom friend (B). Or intercom friend (B) may start an intercom call with you (A).

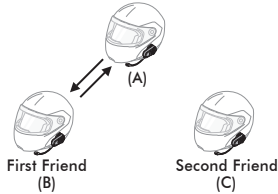

3. You (A) can call the second intercom friend (C) by double tapping the Jog Dial, or the second intercom friend (C) may join the intercom by making an intercom call to you (A).

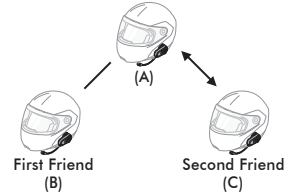

4. Now you (A) and two 10S intercom friends (B & C) are having a three-way conference intercom.

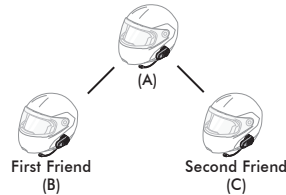

8.2.2 Ending Three-way Intercom

You can completely terminate the conference intercom or just disconnect an intercom connection with one of your active intercom friends.

1. Press the Jog Dial for 3 seconds until you hear a beep to terminate three-way conference intercom completely. It terminates both intercom connections with (B) and (C).
2. Tap or double tap the Jog Dial to disconnect intercom connection with one of the two intercom friends accordingly. For example, by single tapping the Jog Dial, you can terminate the intercom connection with just the first intercom friend (B). However, you still have the intercom connection with your second intercom friend (C).

Jog Dial Operation	Result
Press for 3 seconds	Disconnect (B) & (C)
Single tap	Disconnect (B)
Double tap	Disconnect (C)

End Three-way Intercom

8.3 Four-way Intercom

8.3.1 Starting Four-way Intercom

You can have four-way conference intercom with three other 10S users by adding one more intercom participant to the three-way intercom. While you are having a three-way intercom as above in *section 8.2, "Three-way Intercom"*, a new participant (D), who is an intercom friend of your intercom friend (C), may join the conference intercom by making an intercom call to your intercom friend (C). Please note that in this case, the new participant (D) is an intercom friend of (C), not of you (A).

8.3.2 Ending Four-way Intercom

As same in the case of three-way intercom, you can completely get out of the four-way conference intercom or just disconnect a single intercom connection.

1. Press the Jog Dial for 3 seconds until you hear a beep to terminate four-way conference intercom. It terminates the intercom connections between you (A), and your intercom friends (B) and (C).

2. Tap or double tap the Jog Dial to disconnect the intercom connection with one of the two intercom friends accordingly. However, when you disconnect the second friend (C) by double tapping the Jog Dial, you will be disconnected with the third participant (D) as well. This is because the third participant (D) is connected with you via the second friend (C).

Jog Dial Operation	Result
Press for 3 seconds	Disconnect (B), (C) & (D)
Single tap	Disconnect (B)
Double tap	Disconnect (C) & (D)

End Four-way Intercom

Note:

Multiple headsets are connected during multi-way intercom. With various signals interfering each other, the intercom distance of multi-way intercom is relatively shorter than that of two-way intercom.

9 THREE-WAY CONFERENCE PHONE CALL WITH INTERCOM PARTICIPANT

1. When you have an incoming mobile phone call during an intercom conversation, you will hear a ringtone. You can choose whether to 1) *answer the mobile phone call and stop the intercom conversation, or 2) reject the phone call and stay on the intercom conversation.*
 - 1) To answer the phone call and stop the intercom conversation, tap the Phone Button or the Jog Dial. The VOX Phone feature does not work if you are connected to intercom. When you hang up the phone call, the intercom will automatically be recovered.
 - 2) To reject the phone call and stay on the intercom conversation, press the Jog Dial for 2 seconds until you hear a beep.

Unlike other motorcycle Bluetooth headsets, this prevents a user from being dropped out of an intercom conversation by an incoming mobile call.

2. When you have an incoming intercom call during a mobile phone call, you will hear 4 high-toned beeps, alerting you that there is an incoming intercom call. You will also hear a voice prompt, **“Intercom requested.”** In this case, the intercom call does not override the mobile call because intercom has lower priority than mobile call. You have to hang up the mobile phone call to make or receive an intercom call.
3. You can have a three-way conference phone call by adding an intercom friend to the mobile phone conversation. During a mobile phone conversation, tap the Jog Dial to invite one of the intercom friends to the mobile phone line. To disconnect the intercom first and go back to your private mobile phone call, terminate the intercom by tapping the Jog Dial. To end the mobile phone call first and maintain the intercom conversation, tap the Phone Button, or press the Jog Dial for 2 seconds, or wait for the person on the mobile phone line to end the call.

10 GROUP INTERCOM

Group Intercom allows you to instantly create a multi-way conference intercom with three other most recently paired headsets.

1. Go through intercom pairing with up to three headsets you want to have Group Intercom with.
2. Press the Jog Dial for 3 seconds to begin Group Intercom. The LED will flash green and you will hear a voice prompt, **“Group intercom.”**
3. To terminate Group Intercom, press the Jog Dial for 3 seconds during Group Intercom. You will hear a voice prompt, **“Group intercom terminated.”**

11 UNIVERSAL INTERCOM

You can have an intercom conversation with non-Sena Bluetooth headsets using the Universal Intercom function. Non-Sena Bluetooth headsets can be connected to the Sena Bluetooth headset if they support the Bluetooth Hands-Free Profile (HFP). The working distance may differ depending on the performance of Bluetooth headset that it is connected to. In general, it is shorter than normal intercom distance since it uses the Bluetooth Hands-Free Profile. The Universal Intercom affects both the phone call connection and the multipoint connection (mostly used for GPS connections for riders). You cannot use a multipoint connection device while you are using the Universal Intercom in case as below.

1. If a non-Sena headset does not support a multipoint connection, it cannot use a phone call connection while using the Universal Intercom.
2. As for Sena headsets, the Universal Intercom affects the multipoint connection.
3. If non-Sena headset (already paired as Universal Intercom with Sena) is turned on, then the multipoint connection is automatically deactivated. And the non-Sena headset is automatically connected to Sena headset as a Universal Intercom. So you cannot use multipoint connection devices such as GPS, while a non-Sena headset is turned on.
4. Even though you disconnect the non-Sena headset as a Universal Intercom, it will not automatically restore the multipoint connection. To restore the multipoint connection, you should turn off the non-Sena headset first, then try to connect to multipoint device manually from the device screen or simply reboot the device so that it automatically connects to the Sena headset.

11.1 Universal Intercom Pairing

The 10S can be paired with non-Sena Bluetooth headsets for Bluetooth intercom conversation. You can pair the 10S with only one non-Sena Bluetooth headset so if you pair with a different non-Sena Bluetooth headset, the previous pairing will be removed.

1. Turn on the 10S and a non-Sena Bluetooth headset that you want to pair with.
2. Press the Jog Dial for 10 seconds to enter the configuration menu. Rotate the Jog Dial until you hear a voice prompt, **“Universal intercom pairing.”** Tap the Phone Button to enter into Universal Intercom Pairing mode and the blue LED will flash rapidly and you will hear multiple beeps.
3. Perform the operation required for hands-free pairing on the non-Sena Bluetooth headset (refer to *the User’s Guide for the headsets* you want to use). The 10S will automatically pair with a non-Sena Bluetooth headset when each are in pairing mode.

11.2 Two-way Universal Intercom

You can initiate the Universal Intercom connection with non-Sena Bluetooth headsets using the same intercom connection method as you would between other Sena headsets. You may single tap the Jog Dial to begin an intercom conversation with the first intercom friend, double tap with the second intercom friend, and triple tap with the third intercom friend.

Non-Sena Bluetooth headsets may initiate the Universal Intercom connection, by activating the voice dialer or using the redialing operation. You may also disconnect the existing connection by using the operation to end a call (refer to *the User’s Guide of the headsets* for voice dialer, redialing, and ending a call).

11.3 Three-way Universal Intercom

You may make a three-way Universal Intercom connection with two 10Ss and one non-Sena Bluetooth headset. If the intercom connection is made, all headsets connected cannot use the mobile phone call function since the connection between the headset and the phone is disconnected temporarily. If you disconnect the intercom call, the mobile phone connection is made again automatically so that you can use a mobile phone call function.

1. You (A) need to be paired with a non-Sena Bluetooth headset (B) and another 10S headset (C) for the three-way conference intercom.

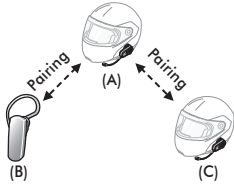

2. Start an intercom conversation with non-Sena Bluetooth headset (B) in your intercom group. For example, you (A) may start an intercom conversation with non-Sena Bluetooth headset (B). The non-Sena Bluetooth headset (B) may also start an intercom call with you (A).

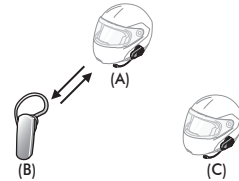

3. The other 10S (C) may join the intercom by making an intercom call to you (A).

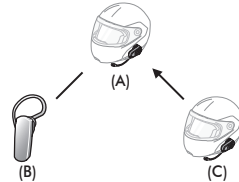

4. Now you (A), non-Sena Bluetooth headset (B), and the other 10S (C) are having a three-way conference intercom.

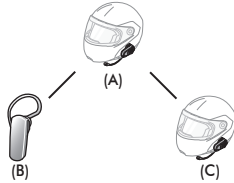

5. You may disconnect three-way Universal Intercom using the same way as you do in normal three-way intercom. Please refer to *section 8.2.2, "Ending Three-way Intercom."*

11.4 Four-way Universal Intercom

You may make a four-way Universal Intercom connection with a couple of different configurations, 1) *three 10Ss and one non-Sena Bluetooth headset* or 2) *two 10Ss and two non-Sena Bluetooth headsets*.

You may have a couple of other Four-way Universal Intercom configurations, 1) *your headset (A), a non-Sena Bluetooth headset (B), another 10S (C), and a non-Sena Bluetooth headset (D)*, 2) *your headset (A), a non-Sena Bluetooth headset (B), and two other 10S headsets (C and D)*. You may make the four-way Universal Intercom call the same way as a normal four-way intercom call.

11.4.1 Four-way Universal Intercom Case 1

Two 10S headsets (A and C) and two non-Sena Bluetooth headsets (B and D)

1. You (A) may start an intercom conversation with the non-Sena Bluetooth headset (B).

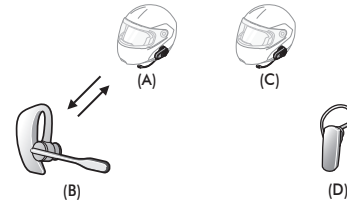

2. The other 10S (C) may join the intercom by making an intercom call to you (A).

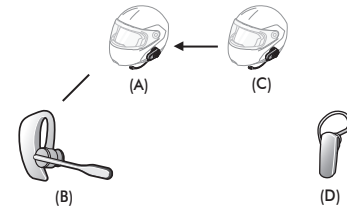

3. The non-Sena Bluetooth headset (D) may join the conference intercom by making an intercom call to the 10S (C).

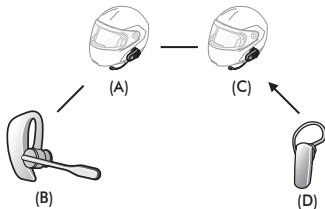

4. Now two 10S headsets (A & C) and two non-Sena Bluetooth headsets (B & D) are connected with the four-way Universal Intercom.

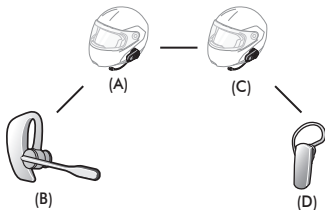

You may disconnect a four-way Universal Intercom using the same way as you do in a normal four-way intercom. Please refer to *section 8.3.2, "Ending Four-way Intercom."*

11.4.2 Four-way Universal Intercom Case 2

Three 10S headsets (A, C and D) and one non-Sena Bluetooth headset (B). The procedure is the same as case 1 described in *section 11.4.1, "Four-way Universal Intercom Case 1."*

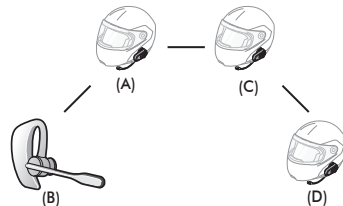

12 FUNCTION PRIORITY

The 10S operates in the following order of priority:

- (highest)** Mobile phone
 Intercom
 Music sharing by Bluetooth stereo music
- (lowest)** Bluetooth stereo music

A lower priority function is always interrupted by a higher priority function.

Note:

If you select music as the audio source priority, the order of priority will change as below:

- (highest)** Mobile phone
 Bluetooth stereo music
 Intercom
- (lowest)** Music sharing by Bluetooth stereo music

13 CONFIGURATION SETTING

13.1 Headset Configuration Setting

1. To enter configuration menu, press and hold the Jog Dial for 10 seconds until you will also hear a voice prompt, “**Configuration menu.**”
2. Rotate the Jog Dial to navigate between the menus. You will hear voice prompts for each menu item as below.
3. You can execute the command by tapping the Phone Button.

Configuration Menu	Tap Phone Button
Delete All Pairings	Execute
Remote Control Pairing	Execute
Universal Intercom Pairing	Execute
Exit Configuration	Execute

13.2 Software Configuration Setting

You can change the settings of the headset through the Sena Device Manager or the Sena Motorcycles App.

13.2.1 Speed Dial

Assign phone numbers for speed dialing to make a phone call quickly.

13.2.2 Language

You can select the device language. The selected language is maintained even when the headset is rebooted.

13.2.3 Audio Source Priority (Default: Intercom)

Audio Source Priority allows you to select the priority between the intercom and music (which includes GPS app instructions and message notifications) from a smartphone. If the intercom is selected as the audio source priority, your music will be interrupted during an intercom conversation. If music is selected as the audio source priority, intercom conversations will be interrupted while your music is heard.

Note:

Audio Source Priority is active only when Audio Multitasking is disabled.

13.2.4 VOX Phone (Default: Enable)

If this feature is enabled, you can answer incoming calls by voice. When you hear a ringtone for an incoming call, you can answer the phone by saying a word such as “**Hello**” loudly or by blowing air into the microphone. VOX phone is temporarily disabled if you are connected to intercom. If this feature is disabled, you have to tap the Phone Button to answer an incoming call.

13.2.5 VOX Intercom (Default: Disable)

If this feature is enabled, you can initiate an intercom conversation with the last connected intercom friend by voice. When you want to start intercom, say a word such as **“Hello”** loudly or blow air into the microphone. If you start an intercom conversation by voice, the intercom terminates automatically when you and your intercom friend remain silent for 20 seconds. However, if you manually start an intercom conversation by tapping the Jog Dial, you have to terminate the intercom conversation manually. However, if you start intercom by voice and end it manually by tapping the Jog Dial, you will not be able to start intercom by voice temporarily. In this case, you have to tap the Jog Dial to restart the intercom. This is to prevent repeated unintentional intercom connections by strong wind noise. After rebooting the headset, you can start intercom by voice again.

13.2.6 VOX Sensitivity (Default: 3)

Vox Sensitivity can adjust the sensitivity of Vox Phone and Vox Intercom. **Level5** is the highest sensitivity setting and **level 1** is the lowest.

13.2.7 HD Voice (Default: Enable)

HD Voice allows you to communicate in high-definition during phone calls. This feature increases the quality so that the audio will be crisp and clear during phone call conversations.

If this feature is enabled, incoming phone calls will interrupt intercom conversations and audio from the SR10 will not be heard during intercom conversations. Three-Way Conference Phone Call with Intercom Participant will not be available if HD Voice is enabled.

Note:

1. Refer to the manufacturer of your Bluetooth device that will be connected to the headset to see if it supports HD Voice.
2. HD Voice is active only when Audio Multitasking is disabled.

13.2.8 HD Intercom (Default: Enable)

HD Intercom enhances the two-way intercom audio from normal quality to HD quality. HD Intercom will become temporarily disabled when you enter into a multi-way intercom. If this feature is disabled, the two-way intercom audio will change to normal quality.

Note:

1. The intercom distance of HD Intercom is relatively shorter than that of normal intercom.
2. HD intercom is active only when Audio Multitasking is disabled.

13.2.9 Voice Prompts (Default: Enable)

You can disable voice prompts by software configuration setting, but the following voice prompts are always on.

- headset configuration setting menu, battery level indicator, speed dial

13.2.10 Sidetone (Default: Disable)

Sidetone is audible feedback of your own voice. It helps you to naturally speak at the correct level according to varying helmet noise conditions. If this feature is enabled, you can hear what you are speaking during an intercom conversation or a phone call.

13.2.11 Advanced Noise Control™ (Always On)

The background noise is reduced during an intercom conversation.

13.2.12 Audio Multitasking™ (Default: Disable)

Audio Multitasking allows you to hear the audio from two features simultaneously. When Audio Multitasking is enabled, intercom conversation can be overlaid with audio from the music or GPS app instructions from a smartphone in the background with reduced volume. Increasing or decreasing the volume of the audio in the foreground will also increase or decrease the volume of the overlaid audio in the background. The volume of the foreground audio can be adjusted using the headset. How much background audio that is heard can be adjusted using the Sena Motorcycles App. HD Intercom, HD Voice, and Audio Source Priority become disabled temporarily when Audio Multitasking is enabled.

Note:

1. *Audio Multitasking will be activated during a two-way intercom conversation with a headset that also supports this feature.*
2. *When Audio Multitasking is disabled, the background audio source will return to its independent volume level.*
3. *For Audio Multitasking to work properly, you need to power the headset off and on. Please restart the headset.*

13.2.13 Background Volume (Default: Level 5)

The Background Volume can be adjustable only when the Audio Multitasking turns on. Level 9 is the highest volume and 0 is the lowest.

14 REMOTE CONTROL

You can remotely control the 10S via Bluetooth using the Handlebar Remote (sold separately). This eliminates the need to take off your hand for button operations. Your 10S and the Handlebar Remote must be paired together before use.

14.1 Pairing with the Handlebar Remote

1. Turn on the 10S and the Handlebar Remote.
2. Press the Jog Dial for 10 seconds to enter the configuration menu. Rotate the Jog Dial until you hear a voice prompt saying, **“Remote control pairing.”** Press the Phone Button to enter into Remote Control Pairing mode and the red LED will flash rapidly and you will hear multiple beeps.
3. On the Handlebar Remote, press the Rear Button for 5 seconds until its LED flashes red and blue. The 10S will automatically perform pairing with the Handlebar Remote in pairing mode. You will hear a voice prompt, **“Remote control connected”**, when they are successfully connected.

14.2 Using the Handlebar Remote

Handlebar Remote button operations on various functions are described in the table below.

Type	Function	Handlebar Remote	LED
Basic Function	Volume adjustment	Move the Joystick up or down	-
	Configuration menu	Press the Front Button for 10 seconds	-
Bluetooth Pairing	Mobile phone pairing	Press the Joystick for 5 seconds	Blue & red alternatively flashing
	Second mobile phone pairing	Press the Front Button for 5 seconds	Blue flashing
		Tap the Rear Button within 2 seconds	
	Media selective pairing	Press the Joystick for 5 seconds	Red flashing
		Tap the Front Button within 2 seconds	
	Phone selective pairing	Press the Joystick for 5 seconds	Blue flashing
Tap the Rear Button within 2 seconds			
GPS Pairing	Press the Front Button for 5 seconds	-	
	Double tap the Rear Button within 2 seconds		

Type	Function	Handlebar Remote	LED
Mobile Phone	Answer/End phone call	Tap the Rear Button	-
	Voice dial	Tap the Rear Button	-
	Speed dial	Double tap the Rear Button	-
	Reject incoming call	Press the Front Button for 2 seconds	-
Intercom	Intercom pairing	Press the Front Button for 5 seconds	Red flashing
		Tap the Front Button of any one of the two headsets	
	Start/End each intercom	Tap the Front Button	-
	End all intercoms	Press the Front Button for 3 seconds	-
	Start Group intercom	Press the Front Button for 3 seconds	Green flashing
	End Group intercom	Press the Front Button for 3 seconds	-
Music	Play/Pause Bluetooth music	Press the Joystick for 1 second	-
	Track forward/back	Move the Joystick left or right for 1 second	-

Handlebar Remote Button Operation Table

15 FIRMWARE UPGRADE

The 10S supports firmware upgrades. You can update the firmware using the Sena Device Manager (please refer to *section 4.7.1, "Sena Device Manager"*).

16 TROUBLESHOOTING

16.1 Intercom Failure

When you try to start an intercom conversation with an intercom friend who is unavailable within range or already having a conference intercom with other riders or a mobile phone call, you will hear low-toned double beeps signifying an intercom busy signal. In this case, you have to try again later.

16.2 Intercom Reconnection

If your intercom friend goes out of range while having an intercom conversation, you may hear static noise and eventually the intercom will be disconnected. In this case, the 10S automatically tries to reconnect the intercom every 8 seconds and you will hear high-toned double beeps until the intercom is reestablished. If you do not want to make a reconnection, tap the Jog Dial to stop the attempt.

16.3 Fault Reset

When the 10S is not working properly or is in faulty status for any reason, you may reset by pushing the pin-hole reset button. Insert a paper clip into the reset pin-hole and press the reset button for a second with light pressure. The 10S will be switched off. Restart the system and try again. This will not restore the headset to factory default settings.

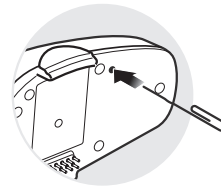

16.4 Factory Reset

1. To restore the 10S to factory default settings, press and hold the Phone Button for 10 seconds until the LED shows solid red and you hear **“Factory reset.”**
2. Within 10 seconds, press the Jog Dial to confirm reset. The headset will be restored to factory setting and switched off automatically. You will hear, **“Headset reset, goodbye.”**
3. If you press the Phone Button or leave the Jog Dial for 10 seconds, the reset attempt is cancelled and the headset returns to stand-by mode. You will hear a voice prompt, **“Cancelled.”**

