

SIEMENS

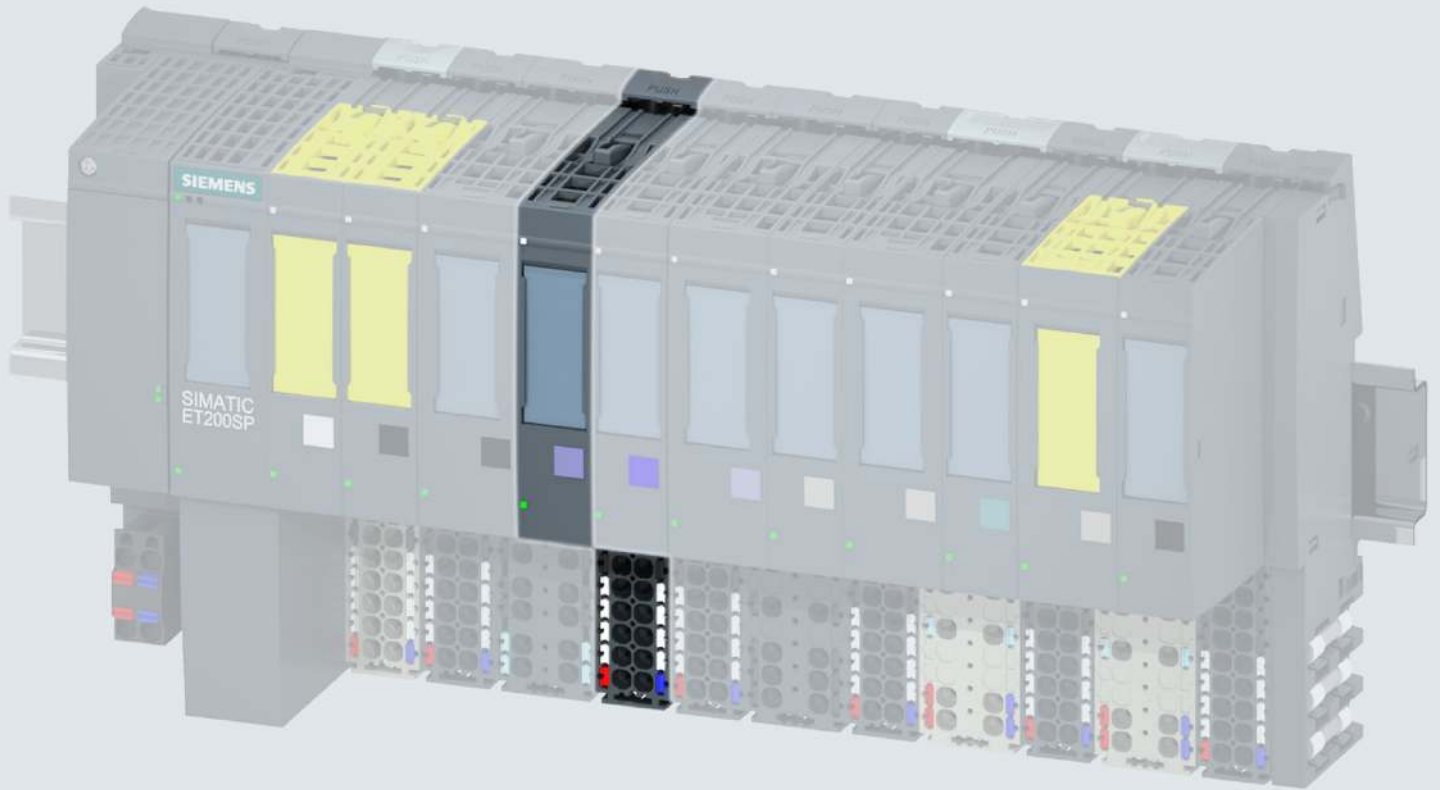

Manual

SIMATIC

ET 200SP

Analog input module
AI 8xRTD/TC 2-wire HF (6ES7134-6JF00-0CA1)

Edition

07/2021

support.industry.siemens.com

SIEMENS

SIMATIC

ET 200SP Analog input module AI 8xRTD/TC 2-wire HF (6ES7134-6JF00-0CA1)



Equipment Manual

Preface	1
ET 200SP Documentation Guide	2
Product overview	3
Wiring	4
Parameters/address space	5
Interrupts/diagnostics alarms	6
Technical specifications	7
Parameter data record	A
Representation of analog values	B

Legal information

Warning notice system

This manual contains notices you have to observe in order to ensure your personal safety, as well as to prevent damage to property. The notices referring to your personal safety are highlighted in the manual by a safety alert symbol, notices referring only to property damage have no safety alert symbol. These notices shown below are graded according to the degree of danger.

 DANGER
indicates that death or severe personal injury will result if proper precautions are not taken.
 WARNING
indicates that death or severe personal injury may result if proper precautions are not taken.
 CAUTION
indicates that minor personal injury can result if proper precautions are not taken.
NOTICE
indicates that property damage can result if proper precautions are not taken.

If more than one degree of danger is present, the warning notice representing the highest degree of danger will be used. A notice warning of injury to persons with a safety alert symbol may also include a warning relating to property damage.

Qualified Personnel

The product/system described in this documentation may be operated only by **personnel qualified** for the specific task in accordance with the relevant documentation, in particular its warning notices and safety instructions. Qualified personnel are those who, based on their training and experience, are capable of identifying risks and avoiding potential hazards when working with these products/systems.

Proper use of Siemens products

Note the following:

 WARNING
Siemens products may only be used for the applications described in the catalog and in the relevant technical documentation. If products and components from other manufacturers are used, these must be recommended or approved by Siemens. Proper transport, storage, installation, assembly, commissioning, operation and maintenance are required to ensure that the products operate safely and without any problems. The permissible ambient conditions must be complied with. The information in the relevant documentation must be observed.

Trademarks

All names identified by ® are registered trademarks of Siemens AG. The remaining trademarks in this publication may be trademarks whose use by third parties for their own purposes could violate the rights of the owner.

Disclaimer of Liability

We have reviewed the contents of this publication to ensure consistency with the hardware and software described. Since variance cannot be precluded entirely, we cannot guarantee full consistency. However, the information in this publication is reviewed regularly and any necessary corrections are included in subsequent editions.

Table of contents

1	Preface	5
1.1	Open Source Software	5
1.2	Security information	5
2	ET 200SP Documentation Guide	7
3	Product overview	13
3.1	Properties	13
4	Wiring	17
4.1	Wiring and block diagram	17
5	Parameters/address space	21
5.1	Measurement types and measuring ranges	21
5.2	Parameters	25
5.3	Explanation of parameters	30
5.4	Scalable measuring range	37
5.4.1	Configuration	39
5.4.2	Evaluating data record 235	40
5.5	Address space	43
6	Interrupts/diagnostics alarms	45
6.1	Status and error displays	45
6.2	Interrupts	47
6.3	Diagnostics alarms	49
7	Technical specifications	51
A	Parameter data record	59
A.1	Dependencies when configuring with GSD file	59
A.2	Parameter assignment and structure of parameter data record	63
A.3	Errors when transferring the data record	72
A.4	Switchable wire break check	73

B	Representation of analog values	75
B.1	Measured values for wire break and reference channel mode	76
B.2	Representation of input ranges	78
B.3	Representation of analog values in voltage measuring ranges	79
B.4	Representation of analog values for resistance-type sensors	80
B.5	Representation of analog values for thermal resistors	81
B.6	Representation of analog values for thermocouples	83

Preface

1.1 Open Source Software

Open-source software is used in the firmware of the I/O modules. Open Source Software is provided free of charge. We are liable for the product described, including the open-source software contained in it, pursuant to the conditions applicable to the product. Siemens accepts no liability for the use of the open source software over and above the intended program sequence, or for any faults caused by modifications to the software.

For legal reasons, we are obliged to publish the original text of the license conditions and copyright notices. Please read the information relating to this on the Internet (<https://support.industry.siemens.com/cs/ww/en/view/109739516>).

See also

GNU_V5.3.1_201805 (<https://support.industry.siemens.com/cs/ww/en/view/109757558>)

1.2 Security information

Siemens provides products and solutions with industrial security functions that support the secure operation of plants, systems, machines and networks.

In order to protect plants, systems, machines and networks against cyber threats, it is necessary to implement – and continuously maintain – a holistic, state-of-the-art industrial security concept. Siemens' products and solutions constitute one element of such a concept.

Customers are responsible for preventing unauthorized access to their plants, systems, machines and networks. Such systems, machines and components should only be connected to an enterprise network or the internet if and to the extent such a connection is necessary and only when appropriate security measures (e.g. firewalls and/or network segmentation) are in place.

For additional information on industrial security measures that may be implemented, please visit (<https://www.siemens.com/industrialsecurity>).

Siemens' products and solutions undergo continuous development to make them more secure. Siemens strongly recommends that product updates are applied as soon as they are available and that the latest product versions are used. Use of product versions that are no longer supported, and failure to apply the latest updates may increase customers' exposure to cyber threats.

To stay informed about product updates, subscribe to the Siemens Industrial Security RSS Feed visit (<https://www.siemens.com/industrialsecurity>).

The documentation for the SIMATIC ET 200SP distributed I/O system is arranged into three areas.

This arrangement enables you to access the specific content you require.

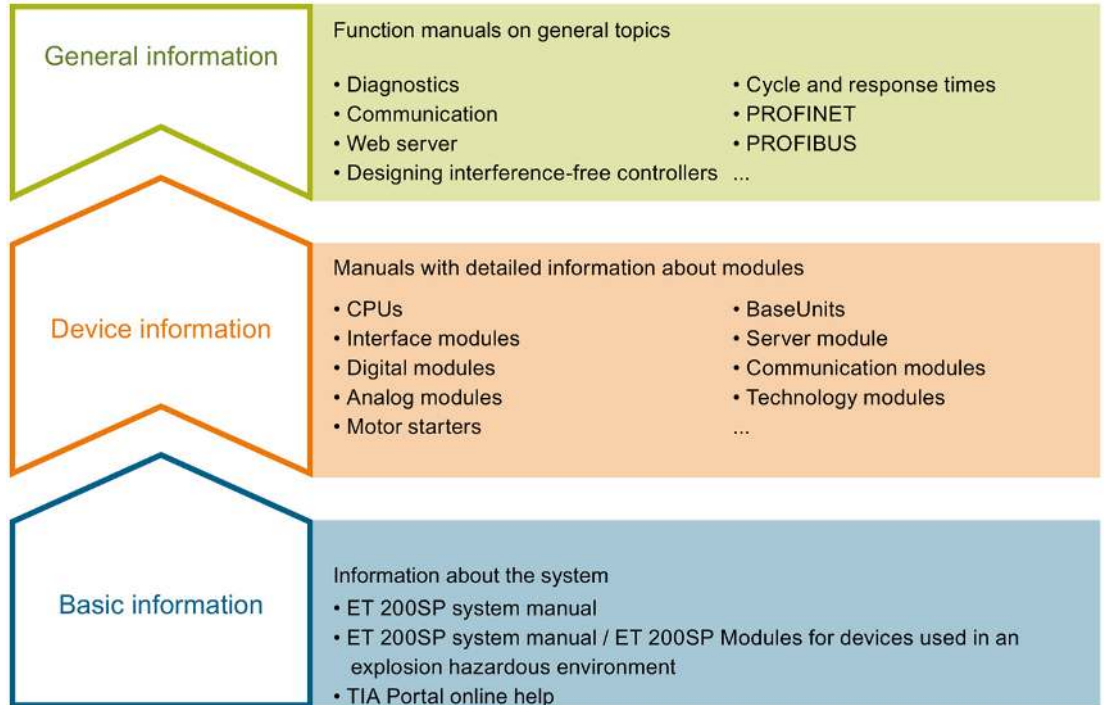

Basic information

The System Manual and Getting Started describe in detail the configuration, installation, wiring and commissioning of the SIMATIC ET 200SP distributed I/O system. The STEP 7 online help supports you in the configuration and programming.

Device information

Product manuals contain a compact description of the module-specific information, such as properties, wiring diagrams, characteristics and technical specifications.

General information

The function manuals contain detailed descriptions on general topics regarding the SIMATIC ET 200SP distributed I/O system, e.g. diagnostics, communication, Web server, motion control and OPC UA.

You can download the documentation free of charge from the Internet (<https://support.industry.siemens.com/cs/ww/en/view/109742709>).

Changes and supplements to the manuals are documented in a Product Information.

You can download the product information free of charge from the Internet (<https://support.industry.siemens.com/cs/us/en/view/73021864>).

Manual Collection ET 200SP

The Manual Collection contains the complete documentation on the SIMATIC ET 200SP distributed I/O system gathered together in one file.

You can find the Manual Collection on the Internet (<https://support.automation.siemens.com/WW/view/en/84133942>).

"mySupport"

With "mySupport", your personal workspace, you make the best out of your Industry Online Support.

In "mySupport", you can save filters, favorites and tags, request CAx data and compile your personal library in the Documentation area. In addition, your data is already filled out in support requests and you can get an overview of your current requests at any time.

You must register once to use the full functionality of "mySupport".

You can find "mySupport" on the Internet (<https://support.industry.siemens.com/My/ww/en>).

"mySupport" - Documentation

With "mySupport", your personal workspace, you make the best out of your Industry Online Support.

In "mySupport", you can save filters, favorites and tags, request CAx data and compile your personal library in the Documentation area. In addition, your data is already filled out in support requests and you can get an overview of your current requests at any time.

You must register once to use the full functionality of "mySupport".

You can find "mySupport" on the Internet (<https://support.industry.siemens.com/My/ww/en/documentation>).

"mySupport" - CAx data

In the CAx data area of "mySupport", you can access the latest product data for your CAx or CAe system.

You configure your own download package with a few clicks.

In doing so you can select:

- Product images, 2D dimension drawings, 3D models, internal circuit diagrams, EPLAN macro files
- Manuals, characteristics, operating manuals, certificates
- Product master data

You can find "mySupport" - CAx data on the Internet (<https://support.industry.siemens.com/my/ww/en/CAxOnline>).

Application examples

The application examples support you with various tools and examples for solving your automation tasks. Solutions are shown in interplay with multiple components in the system - separated from the focus on individual products.

You will find the application examples on the Internet (<https://support.industry.siemens.com/cs/ww/en/ps/ae>).

TIA Selection Tool

With the TIA Selection Tool, you can select, configure and order devices for Totally Integrated Automation (TIA).

This tool is the successor of the SIMATIC Selection Tool and combines the known configurators for automation technology into one tool.

With the TIA Selection Tool, you can generate a complete order list from your product selection or product configuration.

You can find the TIA Selection Tool on the Internet (<https://support.industry.siemens.com/cs/ww/en/view/109767888>).

SIMATIC Automation Tool

You can use the SIMATIC Automation Tool to perform commissioning and maintenance activities simultaneously on various SIMATIC S7 stations as a bulk operation independent of TIA Portal.

The SIMATIC Automation Tool provides a multitude of functions:

- Scanning of a PROFINET/Ethernet system network and identification of all connected CPUs
- Address assignment (IP, subnet, gateway) and station name (PROFINET device) to a CPU
- Transfer of the date and the programming device/PC time converted to UTC time to the module
- Program download to CPU
- RUN/STOP mode switchover
- CPU localization by means of LED flashing
- Reading out of CPU error information
- Reading of the CPU diagnostics buffer
- Reset to factory settings
- Firmware update of the CPU and connected modules

You can find the SIMATIC Automation Tool on the Internet (<https://support.industry.siemens.com/cs/ww/en/view/98161300>).

PRONETA

SIEMENS PRONETA (PROFINET network analysis) allows you to analyze the plant network during commissioning. PRONETA features two core functions:

- The topology overview automatically scans the PROFINET and all connected components.
- The IO check is a fast test of the wiring and the module configuration of a plant, incl. fail-safe inputs and outputs.

You can find SIEMENS PRONETA on the Internet (<https://support.industry.siemens.com/cs/ww/en/view/67460624>).

SINETPLAN

SINETPLAN, the Siemens Network Planner, supports you in planning automation systems and networks based on PROFINET. The tool facilitates professional and predictive dimensioning of your PROFINET installation as early as in the planning stage. In addition, SINETPLAN supports you during network optimization and helps you to exploit network resources optimally and to plan reserves. This helps to prevent problems in commissioning or failures during productive operation even in advance of a planned operation. This increases the availability of the production plant and helps improve operational safety.

The advantages at a glance

- Network optimization thanks to port-specific calculation of the network load
- Increased production availability thanks to online scan and verification of existing systems
- Transparency before commissioning through importing and simulation of existing STEP 7 projects
- Efficiency through securing existing investments in the long term and the optimal use of resources

You can find SINETPLAN on the Internet (<https://www.siemens.com/sinetplan>).

Product overview

3.1 Properties

Article number

6ES7134-6JF00-0CA1

View of the module

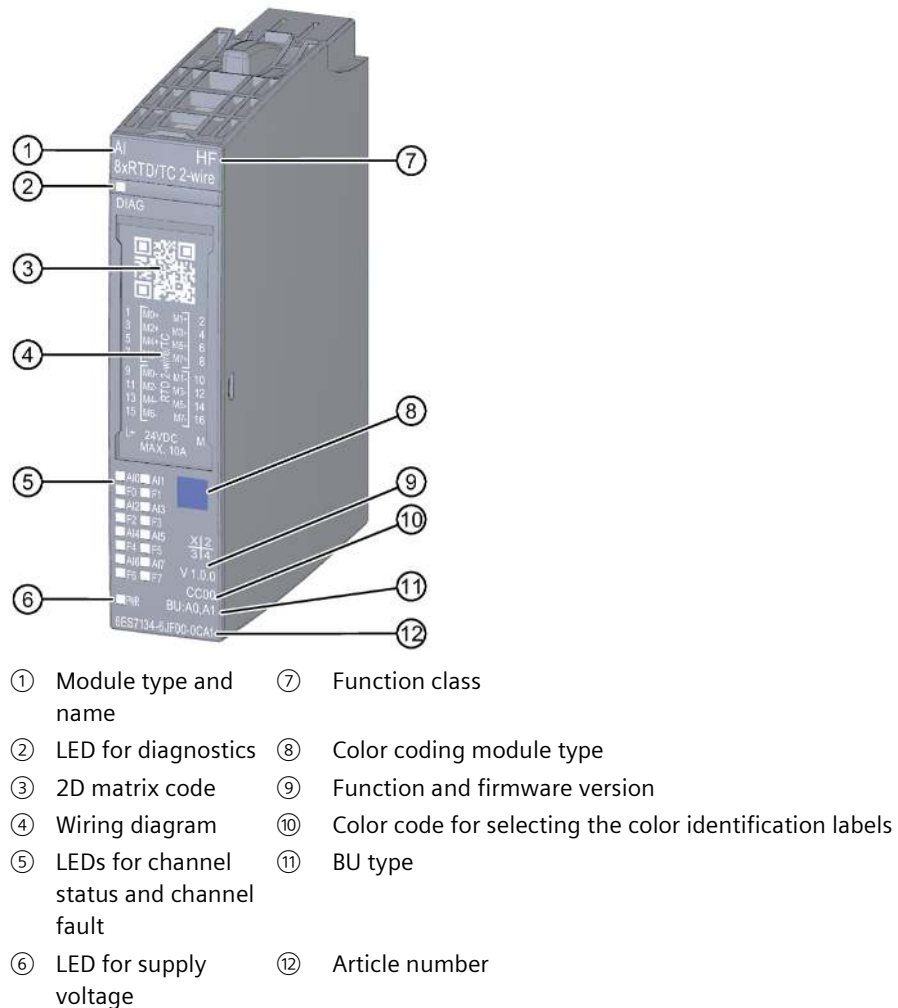

Figure 3-1 View of the module AI 8xRTD/TC 2-wire HF

Properties

The module has the following technical properties:

- Analog input module with 8 inputs
- 4 measurement types, can be set per channel
 - Thermal resistor (RTD)
 - Thermocouple (TC)
 - Resistor
 - Voltage
- Resolution: Up to 16 bits including sign
 - Can be extended to max. 3 decimal places via the scalable measuring range for the measuring types RTD and TC.
- Configurable diagnostics for each channel
- Hardware interrupt on limit violation can be set per channel (two high and two low limits per channel)
- Adjustable compensation
 - RTD: Compensation of the line resistance for a 2-wire connection
 - TC: external or internal temperature compensation
- interference frequency suppression, adjustable

The module supports the following functions:

Table 3- 1 Version dependencies of the functions

Function	HW version	FW version	STEP 7		GSD file	
			TIA Portal	V5.x	PROFINET IO	PROFIBUS DP
Firmware update	FS01	V2.0.0 or higher	V13 or higher	V5.5 SP3 or higher with HSP 0227 V3.0 or higher	X	X
Identification data I&M0 to I&M3	FS01	V2.0.0 or higher	V13 or higher	V5.5 SP3 or higher with HSP 0227 V3.0 or higher	X	X
Reconfiguration in RUN	FS01	V2.0.0 or higher	V13 or higher	V5.5 SP3 or higher with HSP 0227 V3.0 or higher	X	X
Value status (PROFINET IO only)	FS01	V2.0.0 or higher	V13 or higher	V5.5 SP3 or higher with HSP 0227 V3.0 or higher	X	-
Calibration in runtime	FS01	V2.0.0 or higher	V13 or higher	V5.5 SP3 or higher with HSP 0227 V3.0 or higher	X	X
Scalable measuring range	FS01	V2.0.0 or higher	V13 or higher	V5.5 SP3 or higher with HSP 0227 V2.0 or higher	X	X ¹
Configurable conductor resistance	FS01	V2.0.0 or higher	V13 or higher	V5.5 SP3 or higher with HSP 0227 V3.0 or higher	X	X ¹
Switchable wire-break check	FS01	V2.0.0 or higher	V13 or higher	V5.5 SP3 or higher with HSP 0227 V3.0 or higher	X	X
Extended interference frequency suppression <ul style="list-style-type: none"> • 60 Hz (18.75 ms) • 50 Hz (22.5 ms) • 16.6 Hz (67.5 ms) 	FS01	V2.1.0 or higher	V16 or higher with HSP 0357	As of V5.5 SP3 with HSP0227 as of V12.0	X	X ¹

¹ Due to the limited number of parameters of a maximum of 244 bytes per ET 200SP station with a PROFIBUS GSD configuration, the configuration options are restricted. The parameter can only be parameterized later via data record 128.

Accessories

The following accessories must be ordered separately:

- Labeling strips
- Color identification labels
- Reference identification label
- Shield connection

See also

You can find additional information on the accessories in the ET 200SP distributed I/O system (<http://support.automation.siemens.com/WW/view/en/58649293>) system manual.

Wiring

4.1 Wiring and block diagram

This section includes the block diagram of the AI 8xRTD/TC 2-wire HF module with the terminal assignments.

You can find information on wiring the BaseUnit in the ET 200SP distributed I/O system (<https://support.automation.siemens.com/WW/view/en/58649293>) system manual.

Note

- The load group of the module must begin with a light-colored BaseUnit. Keep this in mind also during the configuration.
 - When using floating sensors, bridge the m- connections and connect to ground / FE. This increases the immunity of the module.
Bridging and connecting are not necessary for disabled and disconnected inputs.
-

Note**Compensation of the conductor resistance for RTD or resistance measurement**

For compensation of the conductor resistance, a fixed value for the parasitic conductor resistance of the entire measuring loop can be entered via the corresponding parameter.

Wiring: 2-wire connection for thermocouples, resistance-type sensors or thermal resistors (RTD)

The following figure shows the block diagram and an example of the terminal assignment of the analog input module AI 8xRTD/TC 2-wire HF on the BaseUnit BU type A0/A1.

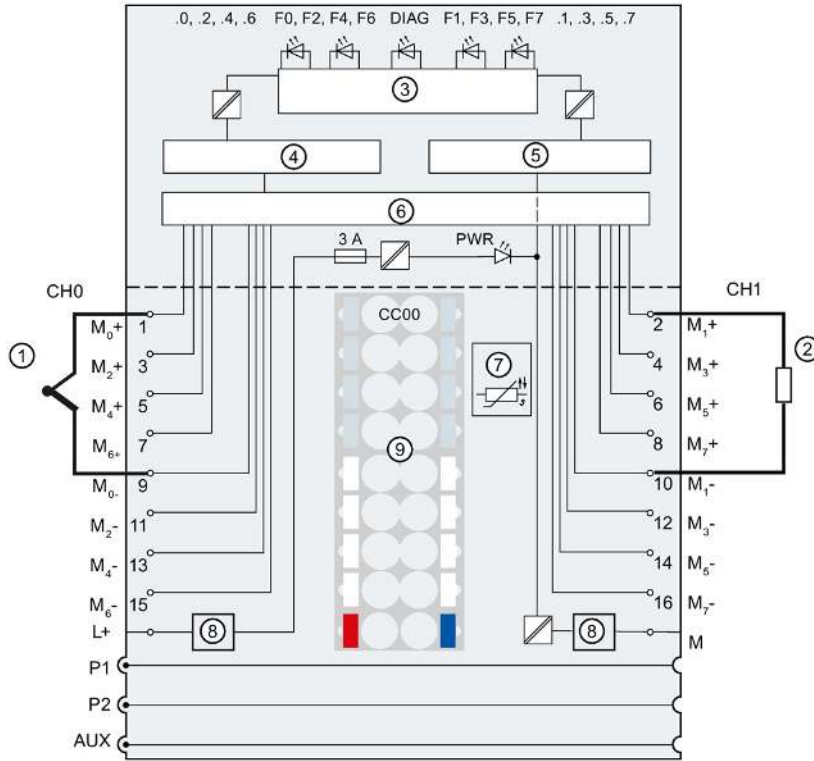

- | | | | |
|---|-------------------------------------------------------------------------------|-----------------|-------------------------------------------------------------------------------------------------------------------------------------------------|
| ① | 2-wire connection of thermocouples | M _{n+} | Measuring line positive, channel n |
| | | M _{n-} | Measuring line negative, channel n |
| ② | 2-wire connection of resistance-type sensors or thermal resistors (RTD) | L+ | 24 V DC (infeed only with light-colored BaseUnit) |
| ③ | Backplane bus interface | P1, P2, AUX | Internal self-assembling voltage buses
Connection to left (dark-colored BaseUnit)
Connection to left interrupted (light-colored BaseUnit) |
| ④ | Analog-to-digital converter (ADC) | DIAG | Diagnostics LED (green, red) |
| ⑤ | Constant current power supply | .0 to .7 | Channel status LED (green) |
| ⑥ | Multiplexer | PWR | Power LED (green) |
| ⑦ | Temperature recording for BU type A1 only | F0 to F7 | Channel fault LED (red) |
| ⑧ | Filter connection supply voltage (available with light-colored BaseUnit only) | | |
| ⑨ | Color-coded label with color code CC00 (optional) | | |

Figure 4-1 Connection- and block diagram for connection of thermocouples, resistance-type sensors or thermal resistors (RTD)

Parameters/address space

5.1 Measurement types and measuring ranges

The following table describes the measuring range and the temperature coefficients you can configure for each measurement type:

Table 5- 1 Measurement types and measuring ranges

Measurement type	Measuring range	Temperature coefficient
Deactivated	–	–
Voltage	±50 mV / ±80 mV / ±250 mV / ±1 V	
Resistor (2-wire connection)	150 Ω / 300 Ω / 600 Ω / 3 kΩ / 6 kΩ	–
	PTC	-
Thermal resistor RTD (2-wire connection)	Climatic / Standard Pt 100 Pt 200 Pt 500 Pt 1000	Pt 0.00385 / Pt 0.003916 / Pt 0.003902 / Pt 0.00392 / Pt 0.00385055
	Climatic / Standard Ni 100 Ni 120 Ni 200 Ni 500 Ni 1000	Ni 0.00618 / Ni 0.00672
	Climatic ¹ / Standard ¹ Ni 1000	Ni 0.005
Thermocouple (TC)	Type E, N, J, K, L, S, R, B, T, C, U, TXK (acc. to GOST)	-

¹ For sensors LG-Ni 1000 from Siemens Building Ltd (Landis & Stäfa).

Special features when using PTC resistors

PTCs are suitable for monitoring temperature and as thermal protection devices for complex drives or transformer windings.

- Choose "Resistor (2-wire)" and "PTC" in the parameter assignment.
- Connect the PTC to the 2-wire connection technology.
- Use the PTC resistors, type A (PTC thermistor) in accordance with DIN/VDE 0660, part 302.
- If "Underflow" diagnostics is enabled, a "Violation of low limit" diagnostics is generated for resistance values $< 18 \Omega$, indicating a short-circuit.
- Sensor data for the PTC resistor:

Table 5-2 Using PTC resistors

Property	Technical specifications	Comment
Switching points	Behavior with rising temperature	
	$< 550 \Omega$	Normal range: • SIMATIC S7: Bit 0 = "0", Bit 2 = "0" (in the PII)
	550 Ω to 1650 Ω	Prewarning range: • SIMATIC S7: Bit 0 = "0", Bit 2 = "1" (in the PII)
	$> 1650 \Omega$	Response range: • SIMATIC S7: Bit 0 = "1", Bit 2 = "0" (in the PII)
	Behavior with falling temperature	
	$> 750 \Omega$	Response range: • SIMATIC S7: Bit 0 = "1", Bit 2 = "0" (in the PII)
	750 Ω to 540 Ω	Prewarning range: • SIMATIC S7: Bit 0 = "0", Bit 2 = "1" (in the PII)
	$< 540 \Omega$	Normal range: • SIMATIC S7: Bit 0 = "0", Bit 2 = "0" (in the PII)
	Reaction to short-circuit	
	$< 18 \Omega$	• SIMATIC S7: Bit 7 (IB x+1) = "1", Bit 0 = "0" and Bit 2 = "0"
(RRT-5) °C (RRT+5) °C (RRT+15) °C Measuring voltage/ voltage at the PTC	Max. 550 Ω min. 1330 Ω min. 4000 Ω Max. 7.5 V ¹	TNF = Rated response temperature of the sensor (according to DIN/VDE 0660)

¹ Below 23 k Ω

Assignment in the process image input (PII) with SIMATIC S7

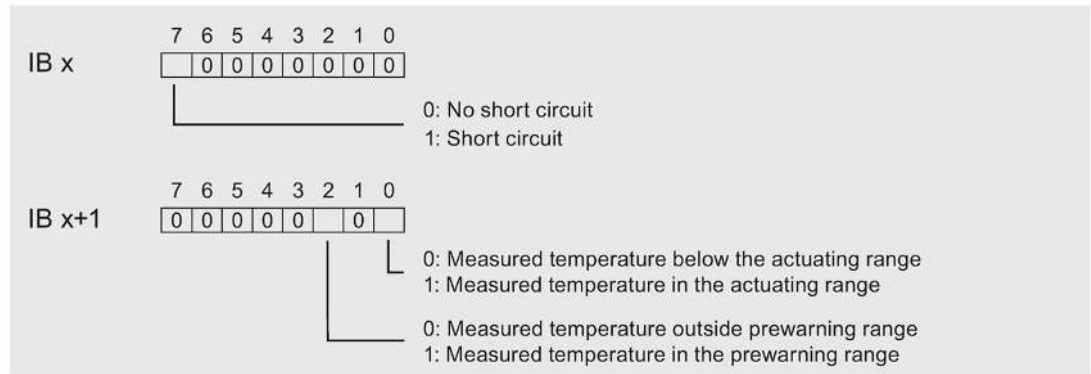

Figure 5-1 Assignment in the process image input (PII)

Notes on programming

- Bits 0+2 are relevant for evaluation in the process image input. You can monitor, for example, the temperature of a motor using bits 0+2.
- Bits 0+2 in the process image input cannot be saved. During parameter assignment, take into consideration that a motor, for example, starts up in a controlled manner (via an acknowledgment).
- Bits 0+2 can never be set at the same time; they are set one after the other.

NOTICE**No measurement is possible in the following cases:**

- When I/O modules are pulled out
- When supply voltage to the I/O module fails
- When there is a wire break or short-circuit in the measuring lines

You should therefore always evaluate the diagnostic entries of AI 8xRTD/TC 2-wire HF for safety reasons.

Example

The diagram shows the temperature curve and the associated switching points.

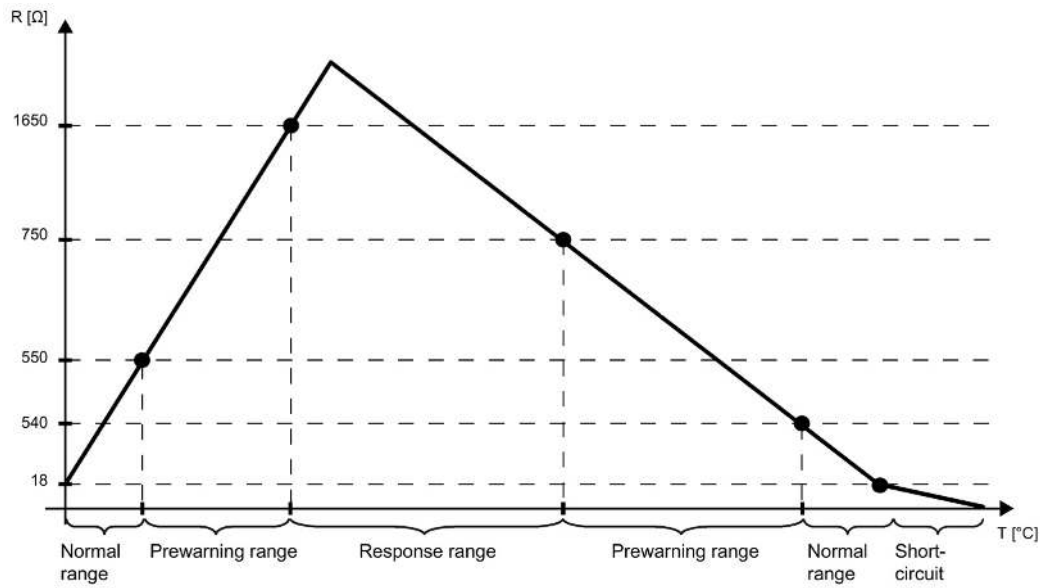

Figure 5-2 Temperature curve with prewarning range

See also

Technical specifications (Page 51)

5.2 Parameters

Parameters of the AI 8xRTD/TC 2-wire HF

Specify the module properties with the various parameters in the course of your STEP 7 configuration. The following table lists the configurable parameters. The effective range of the configurable parameters depends on the type of configuration. The following configurations are possible:

- Central operation with an ET 200SP CPU
- Distributed operation on PROFINET IO in an ET 200SP system
- Distributed operation with PROFIBUS DP in an ET 200SP system

When assigning parameters in the user program, use the WRREC instruction to transfer the parameters to the module by means of data records; see section Parameter assignment and structure of parameter data record (Page 63). The following parameter settings are possible:

Table 5-3 Configurable parameters and their defaults (GSD file)

Parameters	Value range	Default	Reconfiguration in RUN	Scope with configuration software, e.g. STEP 7 (TIA Portal)	
				GSD file PROFINET IO	GSD file PROFIBUS DP
Diagnostics: Missing supply voltage L+	<ul style="list-style-type: none"> • Disable • Enable 	Disable	Yes	Channel	Channel ¹
Diagnostics: Reference junction	<ul style="list-style-type: none"> • Disable • Enable 	Disable	Yes	Channel	Module
Diagnostics: Overflow	<ul style="list-style-type: none"> • Disable • Enable 	Disable	Yes	Channel	Module
Diagnostics: Underflow	<ul style="list-style-type: none"> • Disable • Enable 	Disable	Yes	Channel	
Diagnostics: Wire break	<ul style="list-style-type: none"> • Disable • Enable 	Disable	Yes	Channel	Channel
Type/range of measurement	<ul style="list-style-type: none"> • Deactivated • Voltage ± 50 mV • Voltage ± 80 mV • Voltage ± 250 mV • Voltage ± 1 V 	Thermal resistor (2-wire connection) Pt 100 standard range	Yes	Channel	Channel

5.2 Parameters

Parameters	Value range	Default	Reconfiguration in RUN	Scope with configuration software, e.g. STEP 7 (TIA Portal)	
	Resistor (2-wire connection) <ul style="list-style-type: none"> • 150 Ω • 300 Ω • 600 Ω • 3 kΩ • 6 kΩ 				
Type/range of measurement	Resistor (2-wire connection) PTC	Thermal resistor (2-wire connection) Pt 100 standard range	Yes	Channel	Channel
Type/range of measurement	Thermal resistor (2-wire connection) <ul style="list-style-type: none"> • Pt 100 climatic range • Pt 200 climatic range • Pt 500 climatic range • Pt 1000 climatic range 	Thermal resistor (2-wire connection) Pt 100 standard range	Yes	Channel	Channel
	Thermal resistor (2-wire connection) <ul style="list-style-type: none"> • Pt 100 standard range • Pt 200 standard range • Pt 500 standard range • Pt 1000 standard range 				
Type/range of measurement	Thermal resistor (2-wire connection) <ul style="list-style-type: none"> • Ni 100 climatic range • Ni 120 climatic range • Ni 200 climatic range • Ni 500 climatic range • Ni 1000 climatic range 	Thermal resistor (2-wire connection) Pt 100 standard range	Yes	Channel	Channel
	Thermal resistor (2-wire connection) <ul style="list-style-type: none"> • Ni 100 standard range • Ni 120 standard range • Ni 200 standard range • Ni 500 standard range • Ni 1000 standard range 				

Parameters	Value range	Default	Reconfiguration in RUN	Scope with configuration software, e.g. STEP 7 (TIA Portal)	
Type/range of measurement	Thermocouple <ul style="list-style-type: none"> • Type B (PtRh-PtRh) • Type N (NiCrSi-NiSi) • Type E (NiCr-CuNi) • Type R (PtRh-Pt) • Type S (PtRh-Pt) • Type J (Fe-CuNi) • Type L (Fe-CuNi) • Type T (Cu-CuNi) • Type K (NiCr-NiAl) • Type U (Cu-CuNi) • Type C (WRe-WRe) • Type TXK 	Thermal resistor (2-wire connection) Pt 100 standard range	Yes	Channel	Channel
Temperature coefficient	<ul style="list-style-type: none"> • Pt 0.00385055 • Pt 0.003916 • Pt 0.003902 • Pt 0.00392 • Pt 0.00385 • Ni 0.00618 • Ni 0.00672 • LG-Ni 0.005 	Pt 0.00385055	Yes	Channel	Channel
Temperature unit	<ul style="list-style-type: none"> • Degrees Celsius • Degrees Fahrenheit • Kelvin 	Degrees Celsius	Yes	Channel	Module
Reference junction ⁵	<ul style="list-style-type: none"> • No reference channel mode • Reference channel of the module • Internal reference junction⁶ • Reference channel of group 0 to 3 • Fixed reference temperature 	No reference channel mode	Yes	Channel	Channel
Smoothing	<ul style="list-style-type: none"> • None • Weak • Medium • Strong 	None	Yes	Channel	Channel

5.2 Parameters

Parameters	Value range	Default	Reconfiguration in RUN	Scope with configuration software, e.g. STEP 7 (TIA Portal)	
Interference frequency suppression ³	<ul style="list-style-type: none"> • 60 Hz (50 ms) • 50 Hz (60 ms) ² • 16.6 Hz (180 ms) • 60 Hz (18.75 ms) ⁷ • 50 Hz (22.5 ms) ^{2,7} • 16.6 Hz (67.5 ms) ⁷ 	50 Hz (60 ms)	Yes	Channel	Module
Scalable measuring range	<ul style="list-style-type: none"> • Disable • Enable 	Disable	Yes	Channel	-
Measuring range resolution	<ul style="list-style-type: none"> • 2 decimal places • 3 decimal places 	2 decimal places	Yes	Channel	-
Measuring range center	<ul style="list-style-type: none"> • Value within the nominal range of the measuring range 	0	Yes	Channel	-
Conductor resistance	<ul style="list-style-type: none"> • 0 to 50000 mΩ 	0	Yes	Channel	-
Hardware interrupt high limit 1 ⁴	<ul style="list-style-type: none"> • Disable • Enable 	Disable	Yes	Channel	-
High limit 1 ⁴	<ul style="list-style-type: none"> • Value 	8500	Yes	Channel	-
Hardware interrupt low limit 1 ⁴	<ul style="list-style-type: none"> • Disable • Enable 	Disable	Yes	Channel	-
Low limit 1 ⁴	<ul style="list-style-type: none"> • Value 	-2000	Yes	Channel	-
Hardware interrupt high limit 2 ⁴	<ul style="list-style-type: none"> • Disable • Enable 	Disable	Yes	Channel	-
High limit 2 ⁴	<ul style="list-style-type: none"> • Value 	8500	Yes	Channel	-
Hardware interrupt low limit 2 ⁴	<ul style="list-style-type: none"> • Disable • Enable 	Disable	Yes	Channel	-

Parameters	Value range	Default	Reconfiguration in RUN	Scope with configuration software, e.g. STEP 7 (TIA Portal)	
Low limit 2 ⁴	<ul style="list-style-type: none"> Value 	-2000	Yes	Channel	-
Potential group	<ul style="list-style-type: none"> Use potential group of the left module (dark-colored BaseUnit) Enable new potential group (light-colored BaseUnit) 	Use potential group of the left module (dark-colored BaseUnit)	No	Module	Module

- ¹ Diagnostics: Missing supply voltage L+: Detection per module or alarm per channel
- ² Interference frequency suppression: Interfering signals at 400 Hz are automatically included in the filtering at 50 Hz.
- ³ The settings in the "Interference frequency suppression" parameter have a direct effect on the conversion time of the channel. The analog value is therefore also affected by additionally set filtering via the "Smoothing" parameter.
- ⁴ Due to the limited number of parameters of a maximum of 244 bytes per ET 200SP station with a PROFIBUS GSD configuration, the configuration options are restricted. The parameter length of the I/O module is 24 bytes with PROFIBUS GSD configuration. If necessary, however, you can set these parameters via data record 128, see appendix "Parameter Data Record".
- ⁵ Only for configuration with PROFIBUS GSD file: The set reference junction is used with the additional parameter "Kx Reference junction activated" in the case of "Enable". In the case of "Disable", "No reference channel mode" is used for RTD and "Fixed reference temperature" is used for TC.
- ⁶ Thermocouple types B and C are not suitable for reference junction temperatures below 0 °C on account of their defined characteristic curve as of 0 °C.
- ⁷ By selecting this interference frequency suppression with shorter integration time, the attenuation of the interference frequency that can be achieved is reduced (see Technical Specifications).

Note

Unused channels

"Deactivate" unused inputs in the parameter assignment to shorten the cycle time of the module.

A deactivated input always returns the value 7FFF_H.

Note

For user calibration with a calibration device, deactivate the "Wire-break check" parameter or function.

5.3 Explanation of parameters

Diagnostics: Missing supply voltage L+

Enabling of the diagnostics for missing or insufficient supply voltage L+.

Diagnostics: Reference junction

Enabling of the reference junction diagnostics if the reference temperature of the reference junction needs to be determined for the TC channel being operated.

Reference junction using the PROFINET GSD file

A BaseUnit with an internal temperature sensor (BU..T), the reference channel of group 0, 1, 2, 3, or channel 0 of the I/O module, if it has been configured as "Thermal resistor Pt100 climatic range Degrees Celsius", can be used as reference junction for the TC measurement.

A possible parameter assignment is represented below:

Table 5-4 RTD channel

Setting	Description
No reference channel mode	The temperature value at channel 0 can be used as a reference value for the entire module.
Reference channel of group 0, 1, 2, 3	<p>The channel acts as a transmitter for the reference junction temperature of a group. The distribution is performed via the interface module.</p> <p>The RTD channel must be parameterized as follows:</p> <ul style="list-style-type: none"> • Measurement type/measuring range "Thermal resistance Pt100 climate range" • Temperature unit "Degrees Celsius"

Table 5- 5 TC channel

Setting	Description
Reference channel of the module	<p>The corresponding TC channel uses channel 0 of the same module as the reference junction temperature.</p> <p>This channel must be parameterized as follows, otherwise the reference junction diagnostics is triggered:</p> <ul style="list-style-type: none"> • Measurement type/measuring range "Thermal resistance Pt100 climate range" • Temperature unit "Degrees Celsius" • Reference junction "No reference channel mode"
Internal reference junction	<p>The reference junction temperature is read by an internal temperature sensor on the BaseUnit. Diagnostics: Reference junction is triggered if there is an incorrect BaseUnit type.</p>
Reference channel of group 0, 1, 2, 3	<p>The channel acts as a receiver for the reference junction temperature of a group.</p> <p>The RTD channel must be parameterized as sender as follows:</p> <ul style="list-style-type: none"> • Measurement type/measuring range "Thermal resistance Pt100 climate range" • Temperature unit "Degrees Celsius" • Reference junction: Must be the same reference channel of the group
Fixed reference temperature	<p>The reference temperature of the thermocouple is set to 0 °C. As a result, no temperature compensation is performed.</p>

Note

Shared Device and "Reference channel of group 0, 1, 2, 3"

If the transmitter and receiver for the reference junction temperature of a group are assigned to different IO controllers, then both IO controllers must be performing data exchange with the IO device to ensure error-free operation of the temperature compensation.

Reference junction using the PROFIBUS GSD file

A BaseUnit with an internal temperature sensor (BU..T), the reference channel of group 0, 1, 2, 3, or channel 0 of the I/O module, if it has been configured as "Thermal resistor Pt100 climatic range Degrees Celsius", can be used as reference junction for the TC measurement.

The set temperature unit (e.g. Degrees Celsius) is valid for the entire module with temperature compensation "Reference channel of the module" and "Reference channel of group 0, 1, 2, 3".

Table 5-6 RTD channel

Setting	Description
No reference channel mode	The temperature value at channel 0 can be used as a reference value for the entire module.
Reference channel of group 0, 1, 2, 3	The channel acts as a transmitter for the reference junction temperature of a group. The distribution is performed via the interface module. The RTD channel must be parameterized as follows: <ul style="list-style-type: none"> • Measurement type/measuring range "Thermal resistance Pt100 climate range" • Temperature unit "Degrees Celsius"

Setting	Description
Channel x Reference junction activated	<ul style="list-style-type: none"> • Disable: Channel x is configured with the setting "No reference channel mode". • Enable: Channel x is configured with the setting selected for the "Reference junction" parameter.

Table 5- 7 TC channel

Setting	Description
Reference channel of the module	The corresponding TC channel uses channel 0 of the same module as the reference junction temperature. This channel must be parameterized as follows, otherwise the reference junction diagnostics is triggered: <ul style="list-style-type: none"> • Measurement type/measuring range "Thermal resistance Pt100 climate range" • Temperature unit "Degrees Celsius" • Reference junction "No reference channel mode"
Internal reference junction	The reference junction temperature is read by an internal temperature sensor on the BaseUnit. Diagnostics: Reference junction is triggered if there is an incorrect BaseUnit type.
Reference channel of group 0, 1, 2, 3	The channel acts as a receiver for the reference junction temperature of the group. The RTD channel must be parameterized as sender as follows: <ul style="list-style-type: none"> • Measurement type/measuring range "Thermal resistance Pt100 climate range" • Temperature unit "Degrees Celsius" • Reference junction: Must be the same reference channel of the group
Fixed reference temperature	The reference temperature of the thermocouple is set to 0 °C. As a result, no temperature compensation is performed.

Setting	Description
Channel x Reference junction activated	<ul style="list-style-type: none"> • Disable: Channel x is configured with the setting "Fixed reference temperature". • Enable: Channel x is configured with the setting selected for the "Reference junction" parameter.

Diagnostics: Overflow

Enabling of the diagnostics when the measured value exceeds the overrange.

Diagnostics: Underflow

Enabling of the diagnostics if the measured value falls below the underrange.

Diagnostics: Wire break

Enabling of the diagnostics if the module has no current flow or the current is insufficient for measurement at the correspondingly assigned input.

Type/range of measurement

See the section Measurement types and measuring ranges (Page 21).

Temperature coefficient

The temperature coefficient depends on the chemical composition of the material. In Europe, only one value is used per sensor type (default value).

The temperature coefficient (α value) indicates by how much the resistance of a specific material changes relatively if the temperature increases by 1 °C.

The other values facilitate a sensor-specific setting of the temperature coefficient and enhance accuracy.

Temperature unit

Selection between Degrees Celsius, Fahrenheit and Kelvin as the temperature unit for the selected measuring range.

Smoothing

The individual measured values are smoothed using filtering. The smoothing can be set in 4 levels.

Smoothing time = number of module cycles (k) x cycle time of the module.

The following figure shows how many module cycles it takes for the smoothed analog value to approach 100%, depending on the configured smoothing. This specification is valid for all signal changes at the analog input.

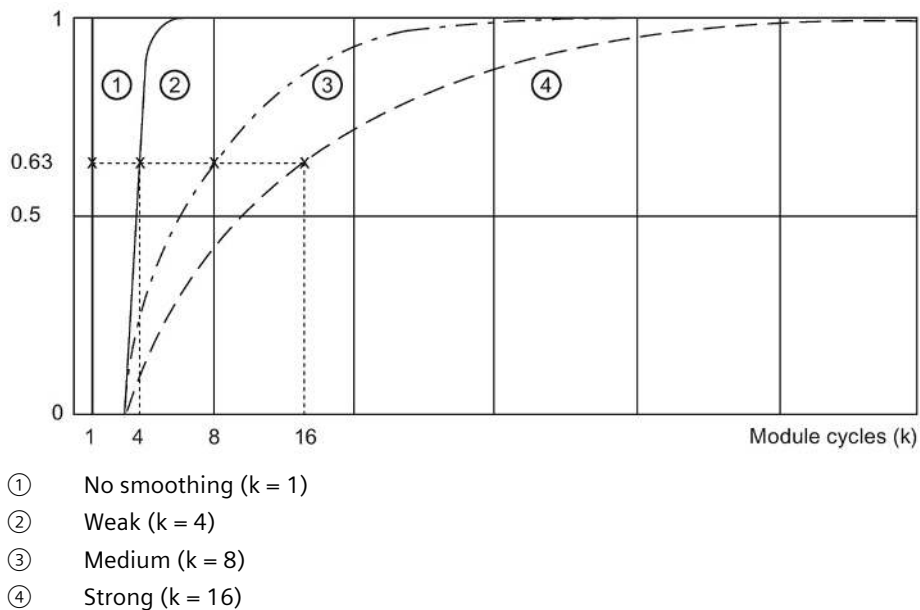

Figure 5-3 Smoothing for AI 8xRTD/TC 2-wire HF

Interference frequency suppression

Suppresses the interferences affecting analog input modules that are caused by the frequency of the AC voltage network used.

The frequency of the AC voltage network is likely to have a negative effect on measured values particularly with measurement in the low voltage range and on thermocouples. With this parameter, the user specifies the line frequency that is predominant in the plant.

Scalable measuring range

See the Scalable measuring range (Page 37) section.

Measuring range resolution

See the Scalable measuring range (Page 37) section.

Measuring range center

See the Scalable measuring range (Page 37) section.

Conductor resistance

Parameters for the measurement types resistor and thermal resistor.

Used to compensate for the conductor resistance without having to interfere with the sensor wiring.

If the "Conductor resistor" parameter is configured higher than a value 0 mΩ, the module then automatically uses the factory calibration data.

Hardware interrupt enable

Enabling of a hardware interrupt if the high limit 1/2 or the low limit 1/2 is violated.

Low limit 1/2

Specify a threshold which triggers a hardware interrupt when violated.

High limit 1/2

Specify a threshold which triggers a hardware interrupt when violated.

Potential group

Specify whether a light-colored BaseUnit with incoming supply voltage or a dark-colored BaseUnit is located in this slot (see ET 200SP distributed I/O system (<https://support.industry.siemens.com/cs/ww/en/view/58649293>) system manual).

A potential group consists of a group of directly adjacent I/O modules within an ET 200SP station, which are supplied via a common supply voltage.

A potential group begins with a light-colored BaseUnit through which the required voltage is supplied for all modules of the potential group. The light-colored BaseUnit interrupts the three self-assembling voltage buses P1, P2 and AUX to the left neighbor.

All additional I/O modules of this potential group are plugged into dark-colored BaseUnits. You take the potential of the self-assembling voltage buses P1, P2 and AUX from the left neighbor.

A potential group ends with a dark-colored BaseUnit, which is followed by a light-colored BaseUnit or server module in the station configuration.

5.4 Scalable measuring range

Function

The scalable measuring range is a limited section of a measuring range supported by the module.

It allows you to increase the resolution for a configurable section.

- The function is enabled with the "Scalable measuring range" parameter.
- The "Measuring range resolution" parameter determines the resolution to 2 or 3 decimal places for a configurable section of the measuring range.
- The "Measuring range center" parameter determines the temperature over which the scalable measuring range is symmetrically spanned.

Note

The scalable measuring range is available for the temperature measuring ranges of thermal resistors (RTD) standard and thermocouples. The measuring ranges for voltage, resistor and thermal resistor climatic are not supported.

The scalable measuring range is valid for the following ranges:

- Nominal range
- Underrange
- Overrange

Value ranges

Table 5- 8 Value ranges

Scalable measuring range	Measuring range resolution		Values hex.
	2 decimal places	3 decimal places	
Overflow	> 325.11	> 32.511	7FFF _H
High limit	325.11	32.511	7EFF _H
Measuring range center	0	0	0 _H
Low limit	-325.12	-32.512	8100 _H
Underflow	<-325.12	<-32.512	8000 _H

To obtain an absolute temperature, the measuring range center in the application program (as offset) must be calculated with the value of the user data of the scalable measuring range.

The measuring range center is always output in the user data as the value "0". The user data are correspondingly mapped to the bipolar input ranges in S7 format. Underflow / overflow is also formed in accordance with the limits of S7.

5.4 Scalable measuring range

Rules

- The measuring range center must be within the nominal range of the underlying measuring range. It is specified in integers.
- The scalable measuring range is spanned symmetrically over the measuring range center. Depending on the resolution, various value ranges result (①, ②).
- The scalable measuring range is limited by underflow and overflow of the underlying measuring range:
 - It is clipped at the underflow when it falls below the limit.
 - It is clipped at the overflow when it exceeds the limit (③).

Example

The following example illustrates the effect of scalable measuring ranges:

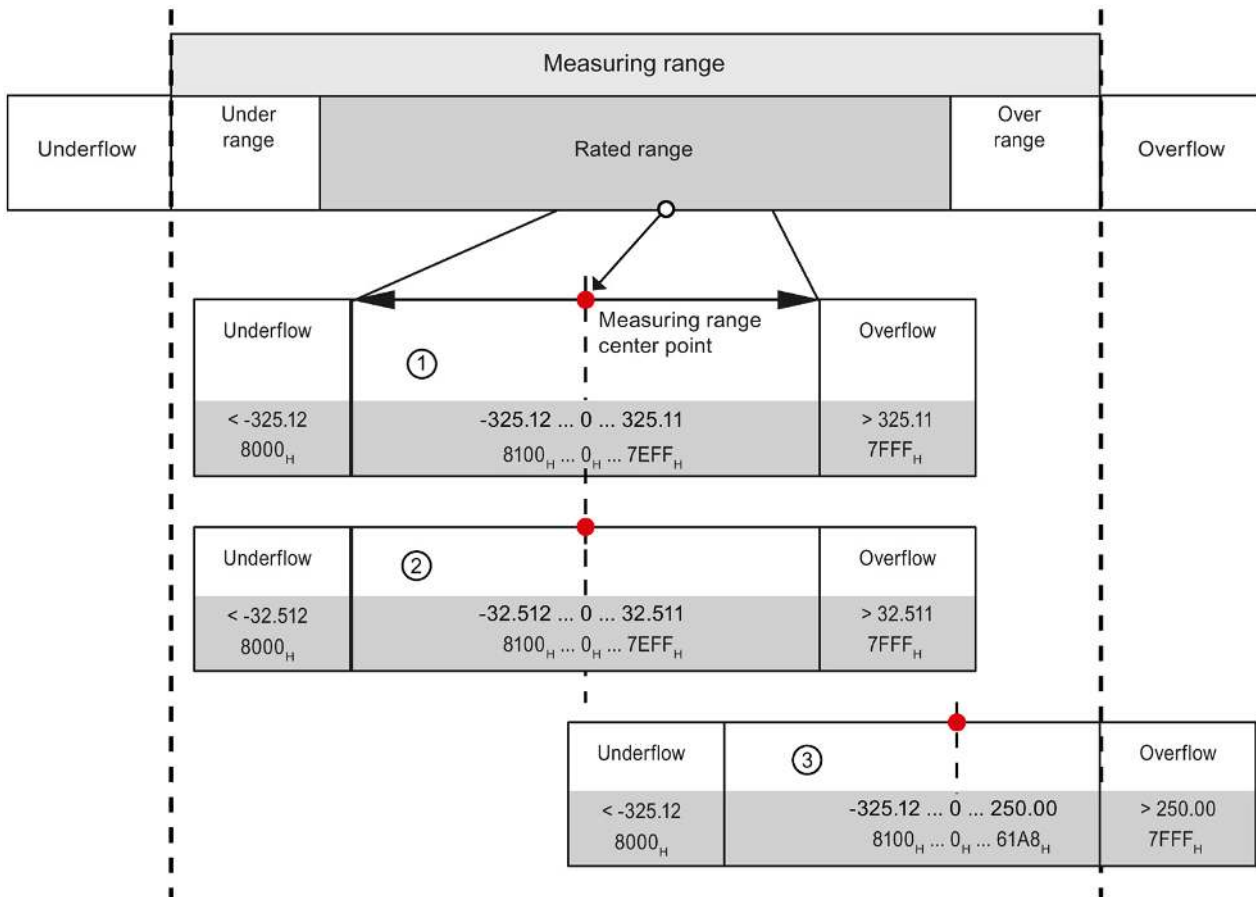

- ① Scalable measuring range with 2 decimal places in hexadecimal S7 format
- ② Scalable measuring range with 3 decimal places in hexadecimal S7 format
- ③ Scalable measuring range which is cut off at the overflow of the underlying measuring range (clipping)

Figure 5-4 Examples of scalable measuring ranges

5.4.1 Configuration

Requirement

You must select a valid temperature measuring range for configuration.

Configuration

The function is activated using the "Scalable measuring range" parameter.

The following figure shows an example of a configuration in STEP 7:

Measurement

Measurement type: Thermal resistor (2-wire) ▾

Measuring range: Pt 100 standard range ▾

Temperature coefficient: Pt 0.00385055 ▾

Temperature unit: Degrees Celsius ▾

Scalable measuring range

Active

Measuring range resolution: 2 decimal places ▾

Measuring range center: 50 °C

Maximum (scalable measuring range): 375.11 °C

Minimum (scalable measuring range): -243.00 °C

Figure 5-5 Configuration for the scalable measuring range

Reference

You will find more information on the configuration in the STEP 7 online help.

5.4.2 Evaluating data record 235

Evaluation in the user program

In the user program, you can evaluate the status and the limits of the scalable measuring range with data record 235, which may result by reaching underflow/overflow.

Structure of data record 235

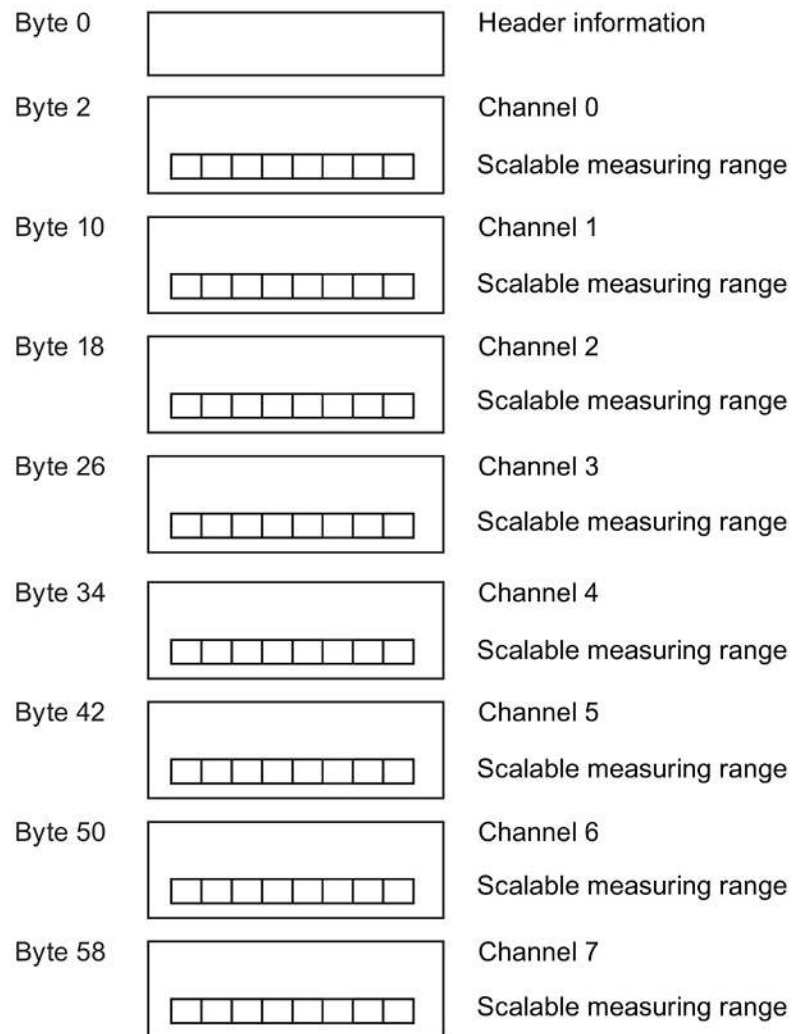

Figure 5-6 Structure of data record 235

Header information

The figure below shows the structure of the header information.

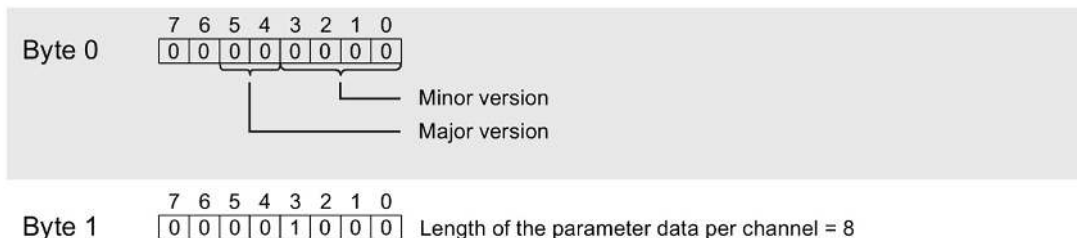

Figure 5-7 Header information of data record 235

Parameters

The figure below shows the structure of the parameter.

If the corresponding bit is set to "1", the parameter is activated.

* $x = 2 + (\text{channel number} \times 8)$

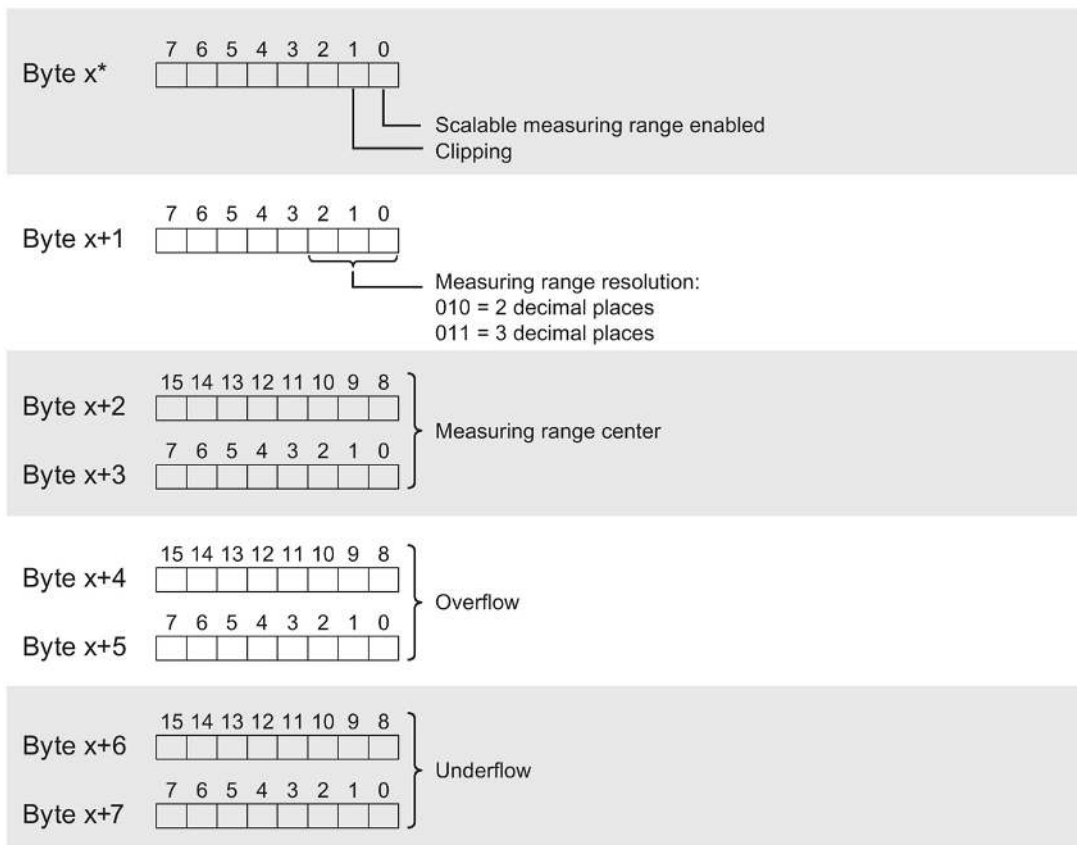

Figure 5-8 Structure of data record 235 - channel parameter byte x to x+7

Description of the parameters

Table 5- 9 Description of the parameters from data record 235

Parameter	Description
Scalable measuring range enabled	1 = Function is active for this channel.
Clipping	1 = Scalable measuring range cut off at the overflow / underflow of the underlying measuring range (see Figure (Page 38)).
Resolution	2 or 3 decimal places
Measuring range center	Temperature in whole °C / °F / K ("working point" for the scaling)
Overflow/underflow	Limits of the scalable measuring range

Example

The following example shows the values for a thermal resistor Pt 100 Standard, °C:

Table 5- 10 Example of a thermal resistor Pt 100 Standard

Hex. value	Dec. value	Evaluation of data record 235
00 _H	0	V0.0
08 _H	8	8 bytes
03 _H	3	Scalable measuring range active and clipped (clipping)
02 _H	2	Resolution: 2 decimal places
02EE _H	750	Measuring range center: 750 °C
61A8 _H	25000	Overflow (Maximum): 250.00 + 750 = 1000.00 °C Scalable measuring range is clipped at the overflow.
8100 _H	-32512	Underflow (Minimum): -325.12 + 750 = 424.88 °C

See also

Scalable measuring range (Page 37)

5.5 Address space

Address space of the analog input module AI 8×RTD/TC 2-wire HF

The figure below shows the assignment of the address space for AI 8×RTD/TC 2-/3-/4-wire HF.

Assignment in the process image input (PII)

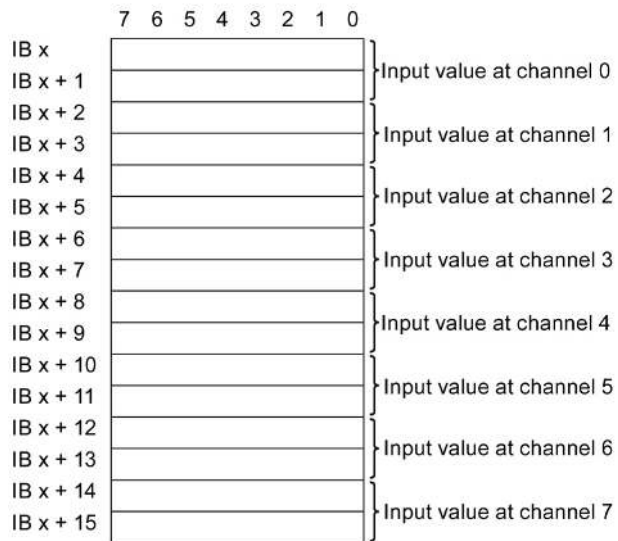

Figure 5-9 Address space AI 8×RTD/TC 2-wire HF without value status

Address space of the analog input module AI 8xRTD/TC 2-wire HF, QI

The figure below shows the assignment of the address space for AI 8xRTD/TC 2-/3-/4-wire HF, QI. The addresses for the value status are only available if the value status is enabled.

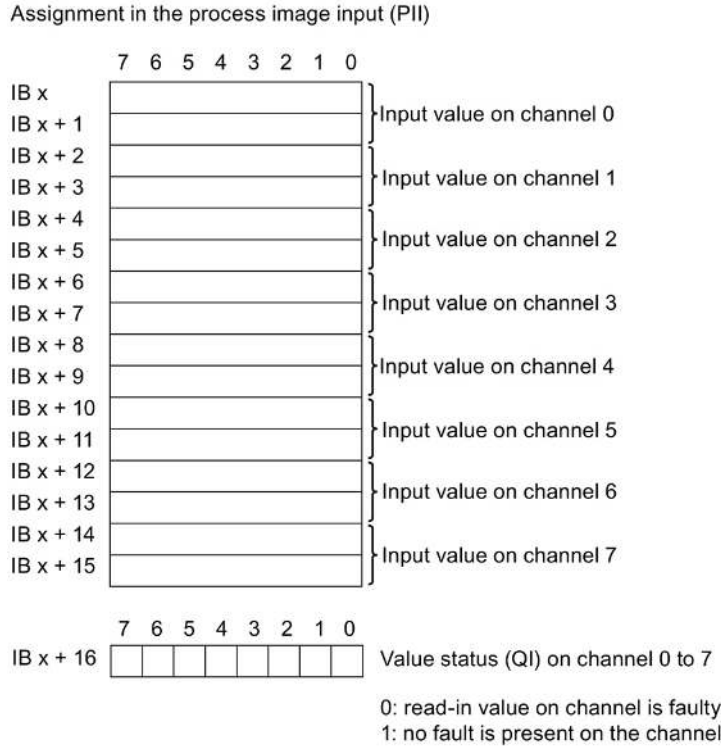

Figure 5-10 Address space of the AI 8xRTD/TC 2-wire HF with value status

Configuration options of the AI 8xRTD/TC 2-wire HF

The following configurations are possible:

- Configuration 1: Without value status
- Configuration 2: With value status

Evaluating the value status (as of firmware version V1.1.0)

An additional byte is occupied in the input address space if you enable the value status for the analog module. Bits 0 to 7 in this byte are assigned to a channel and provide information on the validity of the analog value.

Bit = 1: No fault is present on the channel.

Bit = 0: The channel is disabled or the wiring or the value created on the channel, etc. is incorrect.

Interrupts/diagnostics alarms

6.1 Status and error displays

LED displays

The figure below shows the LED displays of the AI 8xRTD/TC 2-wire HF:

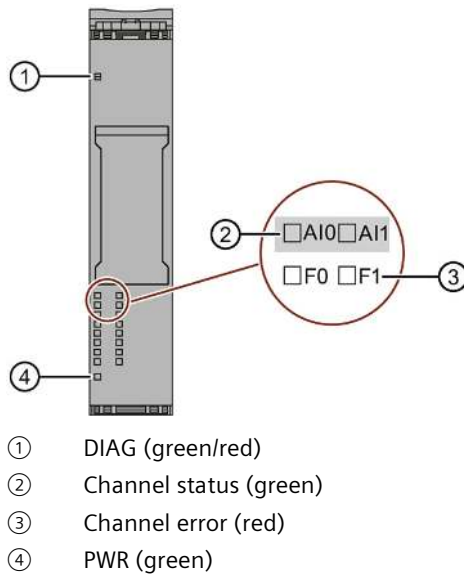





Figure 6-1 LED display

Meaning of the LED displays

The following tables contain the meaning of the status and error displays. Remedies for diagnostics alarms can be found in section Diagnostics alarms (Page 49).









LED DIAG

Table 6-1 LED DIAG fault display

LED DIAG	Meaning
 Off	Backplane bus supply of the system is interrupted or switched off
 Flashes	Module parameters not assigned
 On	Module parameters assigned and no module diagnostics
 Flashes	Module parameters assigned and module diagnostics



Channel status/channel error LED

Table 6-2 Status and error display of the LED channel status / channel error

LEDs		Meaning
Channel status	Channel error	
 Off	 Off	Channel deactivated or no load voltage L+
 On	 Off	Channel activated and no channel diagnostics
 Off	 On	Channel activated and channel diagnostics
 On	 On	Not permitted (error)

PWR LED

Table 6-3 Status display of the PWR LED

PWR LED	Meaning
 Off	Supply voltage L+ missing
 On	Supply voltage L+ present

6.2 Interrupts

Evaluating hardware interrupts with IO controller

The module generates a hardware interrupt at the following events:

- Violation of low limit 1
- Violation of high limit 1
- Violation of low limit 2
- Violation of high limit 2

You can obtain detailed information on the event in the hardware interrupt organization block with the "RALARM" (read additional interrupt information) instruction and in the STEP 7 online help.

The module channel that triggered the hardware interrupt is entered in the start information of the organization block. The following figure shows the assignment to the bits of double word 8 in local data.

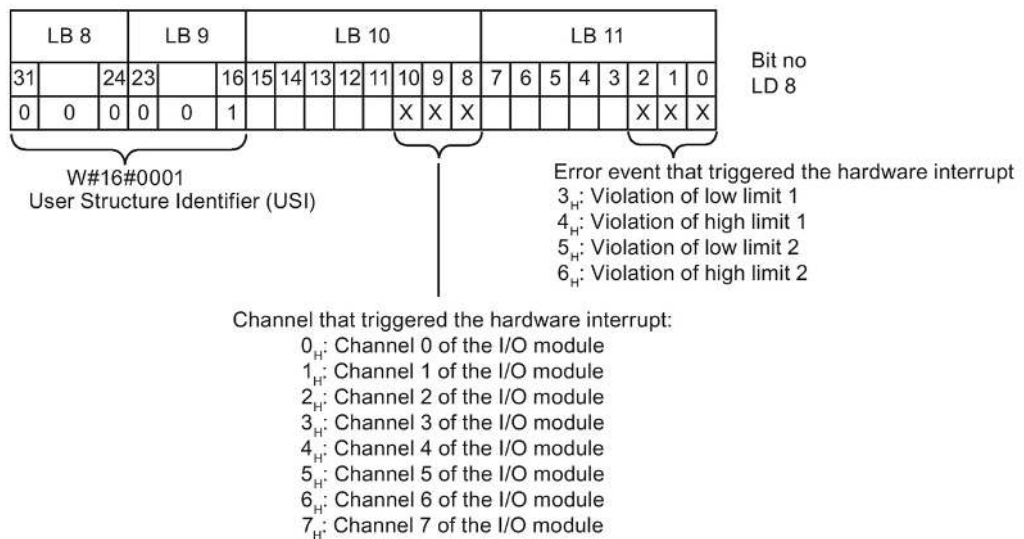

Figure 6-2 OB start information

Structure of the additional interrupt information

Table 6- 4 Structure of the additional interrupt information

Data block name	Content	Comment	Bytes
USI (User Structure Identifier)	W#16#0001	additional interrupt information for hardware interrupts of the I/O module	2
Channel that triggered the hardware interrupt.			
Channel	B#16#00 to B#16#07	Channel 0 to 7 of the I/O module	1
Event that triggered the hardware interrupt.			
Event	B#16#03	Violation of low limit 1	1
	B#16#04	Violation of high limit 1	
	B#16#05	Violation of low limit 2	
	B#16#06	Violation of high limit 2	

Diagnostic error interrupt

The module generates a diagnostic error interrupt at the following events:

- Channel temporarily unavailable
- Hardware interrupt lost
- Reference channel error
- Error
- Violation of low limit
- Violation of high limit
- Wire break
- Supply voltage missing
- Parameter assignment error

6.3 Diagnostics alarms

A diagnostics alarm is generated and the DIAG-LED flashes on the module for each diagnostics event. You can read out the diagnostics alarms, for example, in the diagnostics buffer of the CPU. You can evaluate the error codes with the user program.

Table 6- 5 Diagnostics alarms, their meaning and remedies

Diagnostics alarms	Error code	Meaning	Remedy
Wire break	6H	Resistance of sensor circuit too high	Use a different sensor type or modify the wiring, for example, using cables with larger cross-section
		Wire break between the module and sensor	Connect the cable
		Channel not connected (open)	<ul style="list-style-type: none"> Deactivate diagnostics Connect or deactivate the channel
Violation of high limit ¹	7H	Value lies above the overrange.	Correct module/sensor interplay
		Wire break ²	See Wire break
Violation of low limit ¹	8H	Value lies below the underrange.	Correct module/sensor interplay
Error	9H	Internal module error has occurred (diagnostics alarm on channel 0 applies to the entire module).	Replace module
Parameter assignment error	10H	The module cannot evaluate parameters for the channel. Incorrect parameter assignment.	<ul style="list-style-type: none"> Correct the parameter assignment (diagnostics wire break set only with the permitted measuring ranges).
Supply voltage missing	11H	Missing or insufficient supply voltage L+	<ul style="list-style-type: none"> Check the supply voltage L+ at the BaseUnit Check BaseUnit type
Reference channel error (reference junction)	15H	Reference temperature of the reference junction for the TC channel being operated with compensation is invalid.	<ul style="list-style-type: none"> Check BaseUnit type Select correct reference junction through parameter assignment³ Check whether the reference junction (reference channel of the group 0, 1, 2, 3) is only assigned once as the sender in the entire setup.

6.3 Diagnostics alarms

Diagnostics alarms	Error code	Meaning	Remedy
Hardware interrupt lost	16H	At least one hardware interrupt could not be reported because there were too many pending hardware interrupts.	Correct the program or the process
Channel temporarily unavailable	1FH	Firmware update in progress or update has been canceled. The module does not read any process values in this state.	<ul style="list-style-type: none"> • Wait for firmware update. • Restart the firmware update.
		The channel is currently being calibrated.	<ul style="list-style-type: none"> • Complete calibration.

- ¹ The alarm refers to the diagnostics and depends on the configured measuring range.
- ² For resistor and thermal resistor measuring ranges with deactivated diagnostics for "wire break", this is reported by the "Violation of high limit" diagnostic.
- ³ Shared Device and diagnostics "Reference temperature": If the sender and receiver of the reference junction temperature of a group are assigned to different IO controllers, you may need to download both configurations again in the case of diagnostics. First download the configuration containing the receiver.

Note

Diagnostic messages in the measured value of analog input modules

Each analog input module supplies the measured value 7FFF_H or 8000_H depending on the parameter assignment when an error is detected.

Technical specifications

Technical specifications of the AI 8xRTD/TC 2-wire HF

The following table shows the technical specifications as of 09/2019. You will find a data sheet including daily updated technical specifications on the Internet (<https://support.industry.siemens.com/cs/ww/en/pv/6ES7134-6JF00-0CA1/td?dl=en>).

Article number	6ES7134-6JF00-0CA1
General information	
Product type designation	AI 8xRTD/TC 2-wire HF
HW functional status	From FS05
Firmware version	V2.1
<ul style="list-style-type: none"> FW update possible 	Yes
usable BaseUnits	BU type A0, A1
Color code for module-specific color identification plate	CC00
Product function	
<ul style="list-style-type: none"> I&M data 	Yes; I&M0 to I&M3
<ul style="list-style-type: none"> Isochronous mode 	No
<ul style="list-style-type: none"> Measuring range scalable 	Yes
Engineering with	
<ul style="list-style-type: none"> STEP 7 TIA Portal configurable/integrated from version 	V16, V17 / V18
<ul style="list-style-type: none"> STEP 7 configurable/integrated from version 	V5.5 SP3 / V5.5 SP4
<ul style="list-style-type: none"> PCS 7 configurable/integrated from version 	V8.1 SP1
<ul style="list-style-type: none"> PROFIBUS from GSD version/GSD revision 	One GSD file each, Revision 3 and 5 and higher
<ul style="list-style-type: none"> PROFINET from GSD version/GSD revision 	GSDML V2.35
Operating mode	
<ul style="list-style-type: none"> Oversampling 	No
<ul style="list-style-type: none"> MSI 	No
CiR - Configuration in RUN	
Reparameterization possible in RUN	Yes
Calibration possible in RUN	Yes
Supply voltage	
Rated value (DC)	24 V
permissible range, lower limit (DC)	19.2 V
permissible range, upper limit (DC)	28.8 V
Reverse polarity protection	Yes

Article number	6ES7134-6JF00-OCA1
Input current	
Current consumption, max.	35 mA
Address area	
Address space per module	
• Address space per module, max.	16 byte; + 1 byte for QI information
Hardware configuration	
Automatic encoding	
• Mechanical coding element	Yes
Selection of BaseUnit for connection variants	
• 2-wire connection	BU type A0, A1
Analog inputs	
Number of analog inputs	8
permissible input voltage for voltage input (destruction limit), max.	30 V
Constant measurement current for resistance-type transmitter, typ.	2 mA
Cycle time (all channels), min.	Sum of the basic conversion times and additional processing times (depending on the parameterization of the active channels)
Technical unit for temperature measurement adjustable	Yes; °C/°F/K
Input ranges (rated values), voltages	
• -1 V to +1 V	Yes; 16 bit incl. sign
– Input resistance (-1 V to +1 V)	1 MΩ
• -250 mV to +250 mV	Yes; 16 bit incl. sign
– Input resistance (-250 mV to +250 mV)	1 MΩ
• -50 mV to +50 mV	Yes; 16 bit incl. sign
– Input resistance (-50 mV to +50 mV)	1 MΩ
• -80 mV to +80 mV	Yes; 16 bit incl. sign
– Input resistance (-80 mV to +80 mV)	1 MΩ
Input ranges (rated values), thermocouples	
• Type B	Yes; 16 bit incl. sign
– Input resistance (Type B)	1 MΩ
• Type C	Yes; 16 bit incl. sign
– Input resistance (Type C)	1 MΩ
• Type E	Yes; 16 bit incl. sign
– Input resistance (Type E)	1 MΩ
• Type J	Yes; 16 bit incl. sign
– Input resistance (type J)	1 MΩ
• Type K	Yes; 16 bit incl. sign
– Input resistance (Type K)	1 MΩ

Article number	6ES7134-6JF00-0CA1
<ul style="list-style-type: none"> • Type L <ul style="list-style-type: none"> – Input resistance (Type L) • Type N <ul style="list-style-type: none"> – Input resistance (Type N) • Type R <ul style="list-style-type: none"> – Input resistance (Type R) • Type S <ul style="list-style-type: none"> – Input resistance (Type S) • Type T <ul style="list-style-type: none"> – Input resistance (Type T) • Type U <ul style="list-style-type: none"> – Input resistance (Type U) • Type TXK/TXK(L) to GOST <ul style="list-style-type: none"> – Input resistance (Type TXK/TXK(L) to GOST) 	Yes; 16 bit incl. sign 1 MΩ Yes; 16 bit incl. sign 1 MΩ Yes; 16 bit incl. sign 1 MΩ Yes; 16 bit incl. sign 1 MΩ Yes; 16 bit incl. sign 1 MΩ Yes; 16 bit incl. sign 1 MΩ Yes; 16 bit incl. sign 1 MΩ
Input ranges (rated values), resistance thermometer <ul style="list-style-type: none"> • Ni 100 <ul style="list-style-type: none"> – Input resistance (Ni 100) • Ni 1000 <ul style="list-style-type: none"> – Input resistance (Ni 1000) • LG-Ni 1000 <ul style="list-style-type: none"> – Input resistance (LG-Ni 1000) • Ni 120 <ul style="list-style-type: none"> – Input resistance (Ni 120) • Ni 200 <ul style="list-style-type: none"> – Input resistance (Ni 200) • Ni 500 <ul style="list-style-type: none"> – Input resistance (Ni 500) • Pt 100 <ul style="list-style-type: none"> – Input resistance (Pt 100) • Pt 1000 <ul style="list-style-type: none"> – Input resistance (Pt 1000) • Pt 200 <ul style="list-style-type: none"> – Input resistance (Pt 200) • Pt 500 	Yes; 16 bit incl. sign 1 MΩ Yes; 16 bit incl. sign 1 MΩ Yes; 16 bit incl. sign 1 MΩ Yes; 16 bit incl. sign 1 MΩ Yes; 16 bit incl. sign 1 MΩ Yes; 16 bit incl. sign 1 MΩ Yes; 16 bit incl. sign 1 MΩ Yes; 16 bit incl. sign 1 MΩ Yes; 16 bit incl. sign 1 MΩ Yes; 16 bit incl. sign 1 MΩ Yes; 16 bit incl. sign 1 MΩ

Article number	6ES7134-6JF00-OCA1
– Input resistance (Pt 500)	1 MΩ
Input ranges (rated values), resistors	
• 0 to 150 ohms	Yes; 15 bit
– Input resistance (0 to 150 ohms)	1 MΩ
• 0 to 300 ohms	Yes; 15 bit
– Input resistance (0 to 300 ohms)	1 MΩ
• 0 to 600 ohms	Yes; 15 bit
– Input resistance (0 to 600 ohms)	1 MΩ
• 0 to 3000 ohms	Yes; 15 bit
– Input resistance (0 to 3000 ohms)	1 MΩ
• 0 to 6000 ohms	Yes; 15 bit
– Input resistance (0 to 6000 ohms)	1 MΩ
• PTC	Yes; 15 bit
– Input resistance (PTC)	1 MΩ
Thermocouple (TC)	
Temperature compensation	
– parameterizable	Yes
– Reference channel of the module	Yes
– internal comparison point	Yes; with BaseUnit type A1
– Reference channel of the group	Yes
– Number of reference channel groups	4; Group 0 to 3
– fixed reference temperature	Yes
Cable length	
• shielded, max.	200 m; 50 m with thermocouples
Analog value generation for the inputs	
Measurement principle	integrating (Sigma-Delta)
Integration and conversion time/resolution per channel	
• Resolution with overrange (bit including sign), max.	16 bit
• Integration time, parameterizable	Yes
• Basic conversion time, including integration time (ms)	
– additional processing time for wire-break check	2 ms; In the ranges resistance thermometers, resistors and thermocouples
• Interference voltage suppression for interference frequency f1 in Hz	16.6 / 50 / 60 Hz
• Conversion time (per channel)	180 / 60 / 50 / (67.5 / 22.5 / 18.75) ms

Article number	6ES7134-6JF00-0CA1
Smoothing of measured values	
<ul style="list-style-type: none"> Number of smoothing levels 	4; None; 4/8/16 times
<ul style="list-style-type: none"> parameterizable 	Yes
Encoder	
Connection of signal encoders	
<ul style="list-style-type: none"> for voltage measurement 	Yes
<ul style="list-style-type: none"> for resistance measurement with two-wire connection 	Yes
<ul style="list-style-type: none"> for resistance measurement with three-wire connection 	No
<ul style="list-style-type: none"> for resistance measurement with four-wire connection 	No
Errors/accuracies	
Linearity error (relative to input range), (+/-)	0.01 %; ±0.1 % for resistance thermometers and resistance
Temperature error (relative to input range), (+/-)	0.0009 %/K; ±0.005 % / K at thermocouple
Crosstalk between the inputs, min.	-50 dB
Repeat accuracy in steady state at 25 °C (relative to input range), (+/-)	0.05 %
Operational error limit in overall temperature range	
<ul style="list-style-type: none"> Voltage, relative to input range, (+/-) 	0.1 %
<ul style="list-style-type: none"> Resistance, relative to input range, (+/-) 	0.1 %
Basic error limit (operational limit at 25 °C)	
<ul style="list-style-type: none"> Voltage, relative to input range, (+/-) 	0.05 %
<ul style="list-style-type: none"> Resistance, relative to input range, (+/-) 	0.05 %
Interference voltage suppression for $f = n \times (f1 \pm 1 \%)$, $f1 =$ interference frequency	
<ul style="list-style-type: none"> Series mode interference (peak value of interference < rated value of input range), min. 	70 dB; With conversion time 67.5 / 22.5 / 18.75 ms: 40 dB
<ul style="list-style-type: none"> Common mode voltage, max. 	10 V
<ul style="list-style-type: none"> Common mode interference, min. 	90 dB
Interrupts/diagnostics/status information	
Alarms	
<ul style="list-style-type: none"> Diagnostic alarm 	Yes
<ul style="list-style-type: none"> Limit value alarm 	Yes; two upper and two lower limit values in each case
Diagnoses	
<ul style="list-style-type: none"> Monitoring the supply voltage 	Yes
<ul style="list-style-type: none"> Wire-break 	Yes; channel by channel
<ul style="list-style-type: none"> Group error 	Yes

Article number	6ES7134-6JF00-0CA1
<ul style="list-style-type: none"> • Overflow/underflow 	Yes; channel by channel
Diagnostics indication LED	
<ul style="list-style-type: none"> • Monitoring of the supply voltage (PWR-LED) 	Yes; green PWR LED
<ul style="list-style-type: none"> • Channel status display 	Yes; green LED
<ul style="list-style-type: none"> • for channel diagnostics 	Yes; red LED
<ul style="list-style-type: none"> • for module diagnostics 	Yes; green/red DIAG LED
Potential separation channels	
<ul style="list-style-type: none"> • between the channels 	No
<ul style="list-style-type: none"> • between the channels and backplane bus 	Yes
<ul style="list-style-type: none"> • between the channels and the power supply of the electronics 	Yes
Permissible potential difference between the inputs (UCM)	10 V DC
Isolation	
Isolation tested with	707 V DC (type test)
Ambient conditions	
Ambient temperature during operation	
<ul style="list-style-type: none"> • horizontal installation, min. 	-30 °C
<ul style="list-style-type: none"> • horizontal installation, max. 	60 °C
<ul style="list-style-type: none"> • vertical installation, min. 	-30 °C
<ul style="list-style-type: none"> • vertical installation, max. 	50 °C
Altitude during operation relating to sea level	
<ul style="list-style-type: none"> • Installation altitude above sea level, max. 	2 000 m; On request: Installation altitudes greater than 2 000 m
Dimensions	
Width	15 mm
Height	73 mm
Depth	58 mm

Operational and basic error limits for thermal resistors

Error limits for thermal resistors	
Operational limit (in the entire temperature range, in relation to input range)	
• Pt 100, Pt 200, Pt 500, Pt 1000 standard	±1.0 K
• Pt 100, Pt 200, Pt 500, Pt 1000 climatic	± 0.25 K
• Ni 100, Ni 120, Ni 200, Ni 500, Ni 1000 standard and climatic	± 0.4 K
Basic error limit (operational limit at 25 °C, in relation to input range)	
• Pt 100, Pt 200, Pt 500, Pt 1000 standard	± 0.6 K
• Pt 100, Pt 200, Pt 500, Pt 1000 climatic	± 0.13 K
• Ni 100, Ni 120, Ni 200, Ni 1000 standard and climatic	± 0.2 K

Operational and basic error limits for thermocouples ¹

Error limits for thermocouples	
Operational limit for thermocouples (in the entire temperature range)	±1.5 K
Basic error limit for thermocouples (operational limit at 25 °C)	±1 K
Overall error limits when using internal compensation	
• Operational limit (in the entire temperature range at static thermal state, ambient temperature change < 0.3 K/min)	± 2.5 K
• Basic error limit (operational limit at 25 °C at static thermal state, ambient temperature change < 0.3 K/min)	±1.5 K

- ¹ The indicated error limits apply as of the following temperatures:
- Thermocouple type T: -200 °C
 - Thermocouple type K: -100 °C
 - Thermocouple type B: +700 °C
 - Thermocouple type N: -150 °C
 - Thermocouple type E: -150 °C
 - Thermocouple type R: +200 °C
 - Thermocouple type S: +100 °C

Dimension drawing

See manual ET 200SP BaseUnits

(<http://support.automation.siemens.com/WW/view/en/59753521>)

Parameter data record

A.1 Dependencies when configuring with GSD file

When configuring the module with a GSD file, remember that the settings of some parameters are dependent on each other.

Configuring with a PROFINET GSD file

The table lists the properties and their dependencies on the measurement type and measuring range for PROFINET.

Table A-1 Dependencies of the measurement type / measuring range

Measurement type	Measuring range	Temperature coefficient	Reference junction	Temperature unit	Conductor resistance
Deactivated	*	*	*	*	*
Voltage	±50 mV, ±80 mV, ±250 mV, ±1 V	*	*	*	*
Resistor	150 Ω, 300 Ω, 600 Ω, 3 kΩ, 6 kΩ	*	*	*	x
Resistor	PTC	*	*	*	*
Thermal resistor	Pt100 climatic	Pt 0.00385055 Pt 0.003916 Pt 0.003902 Pt 0.00392 Pt 0.00385	Reference channel of group 0, 1, 2, 3	Degrees Celsius	x
			No reference channel mode	Degrees Celsius Degrees Fahrenheit	
	Pt200 Pt500 Pt1000 climatic		No reference channel mode	Degrees Celsius Degrees Fahrenheit	
	Ni100 Ni120 Ni200 Ni500 Ni1000 climatic	Ni 0.00618 Ni 0.00672			
	LG-Ni 1000 climatic	LG-Ni 0.005			
Thermal resistor	Pt100 Pt200 Pt500 Pt1000 standard	Pt 0.00385055 Pt 0.003916 Pt 0.003902 Pt 0.00392 Pt 0.00385	No reference channel mode	Degrees Celsius Degrees Fahrenheit Kelvin	x
	Ni100 Ni120 Ni200 Ni500 Ni1000 standard	Ni 0.00618 Ni 0.00672			
	LG-Ni 1000 standard	LG-Ni 0.005			

A.1 Dependencies when configuring with GSD file

Measurement type	Measuring range	Temperature coefficient	Reference junction	Temperature unit	Conductor resistance
Thermocouple	Type B, N, E, R, S, J, L, T, K, U, C, TXK	*	Reference channel of the module ¹	Degrees Celsius Degrees Fahrenheit Kelvin	*
			Internal reference junction		
			Reference channel of group 0, 1, 2, 3 ²		
			Fixed reference temperature		

x = property is allowed, – = property is **not allowed**, * = property is not relevant

¹ Use of "Reference channel of the module":

- Channel 0 must be set as "Pt100 climatic" with temperature unit: "Degrees Celsius".
- For each TC channel of this module that is intended to use channel 0 as reference, "Reference junction" must be set to "Reference channel of the module".

² Use of "Reference channel of group 0, 1, 2, 3":

- An RTD channel must be set as "Pt100 climatic" with temperature unit: "Degree Celsius".
- The "Reference junction" of this channel must be configured with "Reference channel of group 0, 1, 2, 3".
- There must only be one RTD channel with "Reference junction" = "Reference channel of group 0, 1, 2, 3" per group 0, 1, 2, 3 and I/O device!
- Each TC channel in the I/O device which is to use this reference must be configured with "Reference channel of group 0, 1, 2, 3" at "Reference junction".
- If the reference channel is on channel 0, it can be used simultaneously as "Reference channel of the module".

Configuring with a PROFINET GSD file

The table lists the properties and their dependencies on the measurement type for PROFINET.

Table A- 2 Dependencies on the measurement type

Measurement type	Scalable measuring range	Measuring range resolution	Diagnostics				
			Underflow	Overflow	Wire break	Missing supply voltage L+	Reference junction
Deactivated	*	*	*	*	*	*	*
Voltage	–	*	x	x	–	x	–
Resistor	–	*	x	x	x	x	–
Resistor	–	*	x	–	–	x	–
Thermal resistor	x	2 and 3 decimal places	x	x	x	x	–
Thermocouple	x	2 and 3 decimal places	x	x	x	x	x ¹⁾

x = property is allowed, – = property is **not allowed**, * = property is not relevant

¹ Property is not relevant if "Fixed reference temperature" is used

Configuring with a PROFIBUS GSD file

The table lists the properties and their dependencies on the measurement type and measuring range for PROFIBUS.

Measurement type	Measuring range	Temperature coefficient	Slot reference junction	Temperature unit	Diagnostics			
					Underflow / overflow	Wire break	Missing supply voltage L+	Reference junction
Deactivated	*	*	*	*	*	*	*	*
Voltage	±50 mV ±80 mV ±250 mV ±1 V	*	*	*	x	–	x	–
Resistor	150 Ω 300 Ω 600 Ω 3 kΩ 6 kΩ	*	*	*	x	x	x	–
Resistor	PTC ³	*	*	*	x	–	x	–
Thermal resistor	Pt100 climatic	Pt 0.0038505 5 Pt 0.003916 Pt 0.003902	Reference channel of group 0, 1, 2, 3	Degrees Celsius	x	x	x	–
		Pt 0.00392 Pt 0.00385	No reference channel mode	Degrees Celsius Degrees Fahrenheit	x	x	x	–
	Pt200 Pt500 Pt1000 climatic	Pt 0.0038505 5 Pt 0.003916 Pt 0.003902 Pt 0.00392 Pt 0.00385	No reference channel mode	Degrees Celsius Degrees Fahrenheit	x	x	x	–
Thermal resistor	Pt100 Pt200 Pt500 Pt1000 standard	Pt 0.0038505 5 Pt 0.003916 Pt 0.003902 Pt 0.00392 Pt 0.00385	No reference channel mode	Degrees Celsius Degrees Fahrenheit Kelvin	x	x	x	–
				Degrees Celsius Degrees Fahrenheit	x	x	x	–
				Degrees Celsius Degrees Fahrenheit Kelvin	x	x	x	–
Thermal resistor	Ni100 Ni120 Ni200 Ni500 Ni1000 climatic	Ni 0.00618 Ni 0.00672	No reference channel mode	Degrees Celsius Degrees Fahrenheit	x	x	x	–
				Degrees Celsius Degrees Fahrenheit	x	x	x	–
				Degrees Celsius Degrees Fahrenheit Kelvin	x	x	x	–

A.1 Dependencies when configuring with GSD file

Measure	Measuring	Temperatu	Slot	Temperatu	Diagnostics			
Thermal resistor	LG-Ni 1000 climatic	LG-Ni 0.005	No reference channel mode	Degrees Celsius Degrees Fahrenheit	x	x	x	–
	LG-Ni 1000 standard	LG-Ni 0.005	No reference channel mode	Degrees Celsius Degrees Fahrenheit Kelvin	x	x	x	–
Thermocouple	Type B, N, E, R, S, J, L, T, K, U, C, TXK	*	Reference channel of the module ¹	Degrees Celsius Degrees Fahrenheit Kelvin	x	x	x	x
			Internal reference junction Reference channel of group 0, 1, 2, 3 ²					
			Fixed reference temperature	Degrees Celsius Degrees Fahrenheit Kelvin	x	x	x	*

x = property is allowed, – = property is **not allowed**, * = property is not relevant

- 1 Use of the "Reference channel of the module":
 - Channel 0 must be set to "Pt100 climatic" with the temperature unit "Degrees Celsius".
 - For each TC channel of this module that is intended to use channel 0 as reference, "Reference junction" must be set to "Enable".
- 2 Use of "Reference channel of group 0":
 - An RTD channel must be configured as "Pt100 climatic" with temperature unit "Degree Celsius".
 - "Reference channel of group 0, 1, 2, 3" must be configured as the "Reference junction" of this channel.
 - There must only be one RTD channel with "Reference junction activated" = "Enabled" per group and line!
 - Each TC channel of this line which is to use this reference must be configured with "Enabled" for "Reference junction activated".
- 3 Underflow = 8000H; wire break and overflow lead to 01H (triggered) → (no diagnostics), wire break and overflow are therefore not relevant.

A.2 Parameter assignment and structure of parameter data record

The data record of the module has an identical structure, regardless of whether you configure the module with PROFIBUS DP or PROFINET IO. With data record 128, you can reconfigure the module in your user program regardless of your programming. This means that you can use all the functions of the module even if you configured it via PROFIBUS-GSD.

Parameter assignment in the user program

You can reassign the module parameters in RUN. For example, the measuring range of selected channels can be changed in RUN without having an effect on the other channels.

Changing parameters in RUN

The "WRREC" instruction is used to transfer the parameters to the module using data record 128. The parameters set with STEP 7 will not be changed on the CPU, which means that the parameters set in STEP 7 will be valid again after a restart.

Output parameter STATUS

If errors occur when transferring parameters with the "WRREC" instruction, the module continues operation with the previous parameter assignment. The STATUS output parameter contains a corresponding error code.

You will find a description of the "WRREC" instruction and the error codes in the STEP 7 online help.

Structure of data record 128

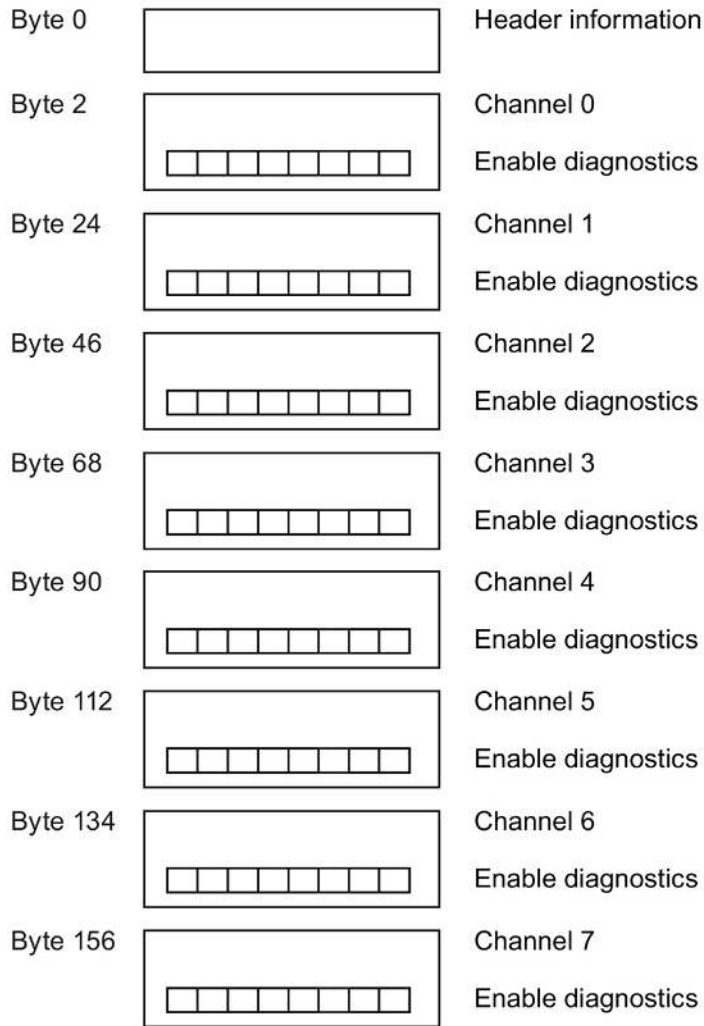

Figure A-1 Structure of data record 128

Header information

The figure below shows the structure of the header information.

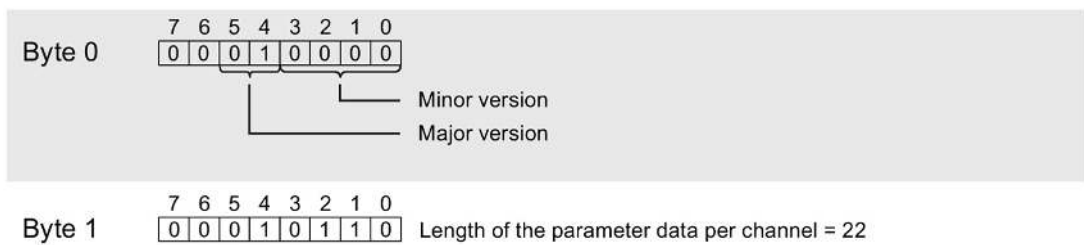

Figure A-2 Header information

Parameters

The figure below shows the structure of the parameters for channels 0 to 7.

You can activate a parameter by setting the corresponding bit to "1".

* $x = 2 + (\text{channel number} \times 22)$; channel number = 0 to 7

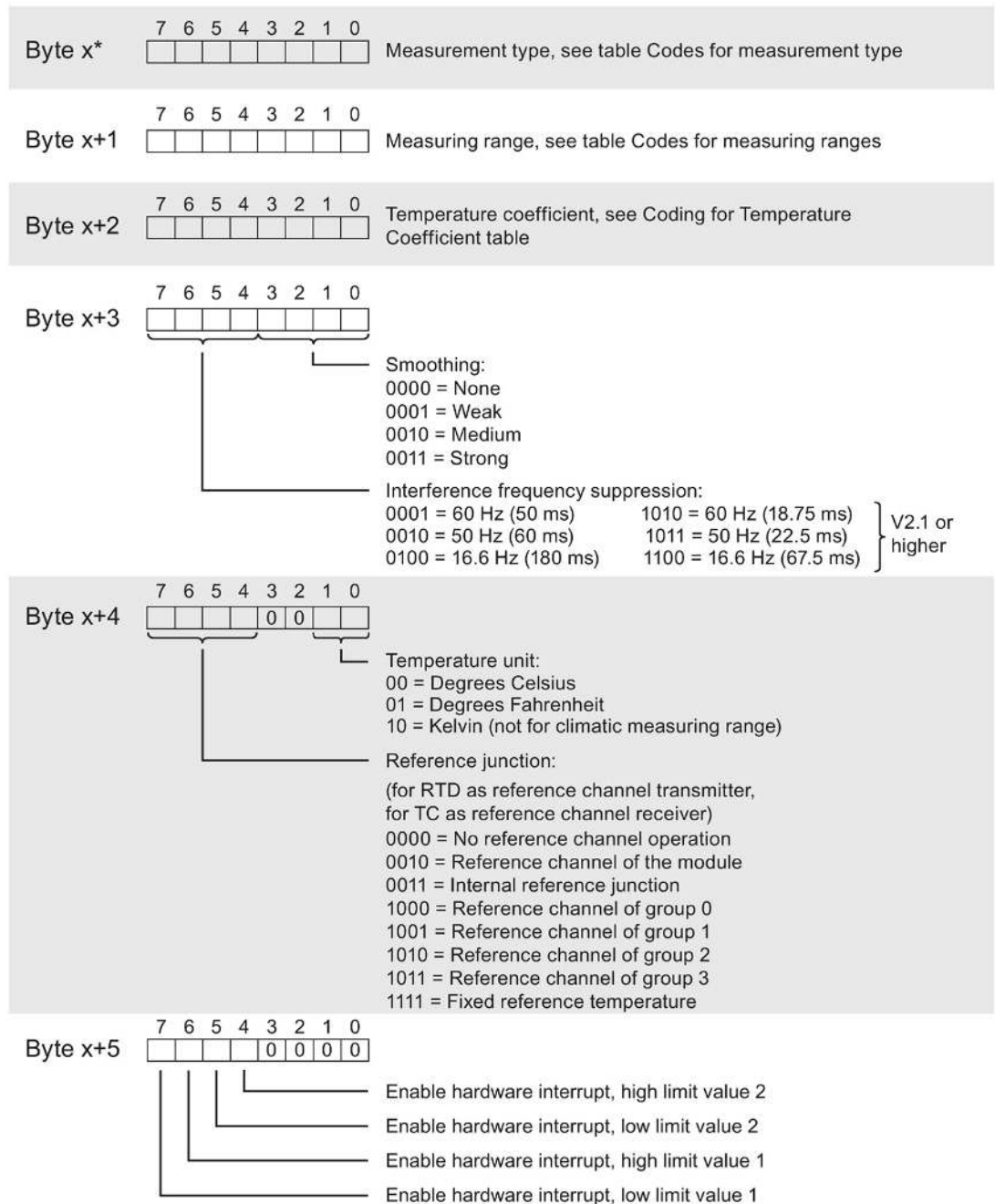

A.2 Parameter assignment and structure of parameter data record

Figure A-3 Structure DS128 AI 4RTD TC 234wire x+5

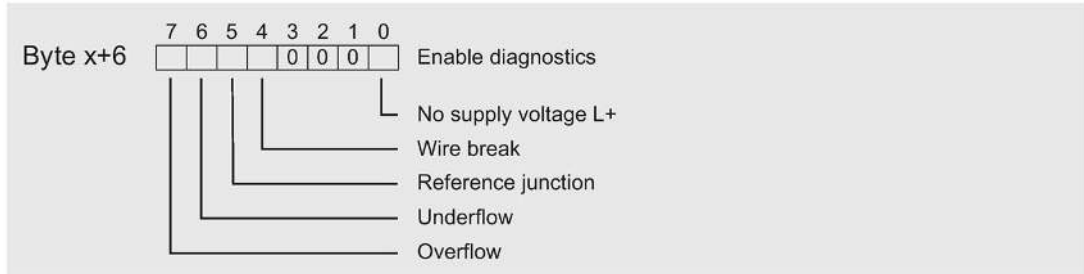

Figure A-4 Structure_of_the_data_record_AI 4RTD TC 234wire_Part2

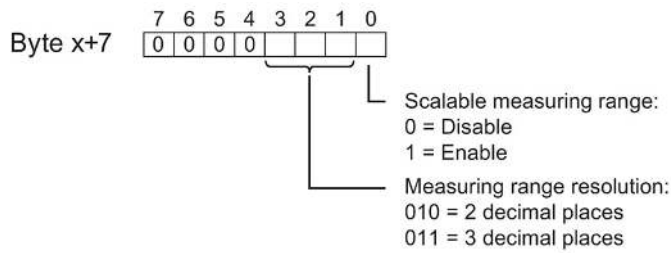
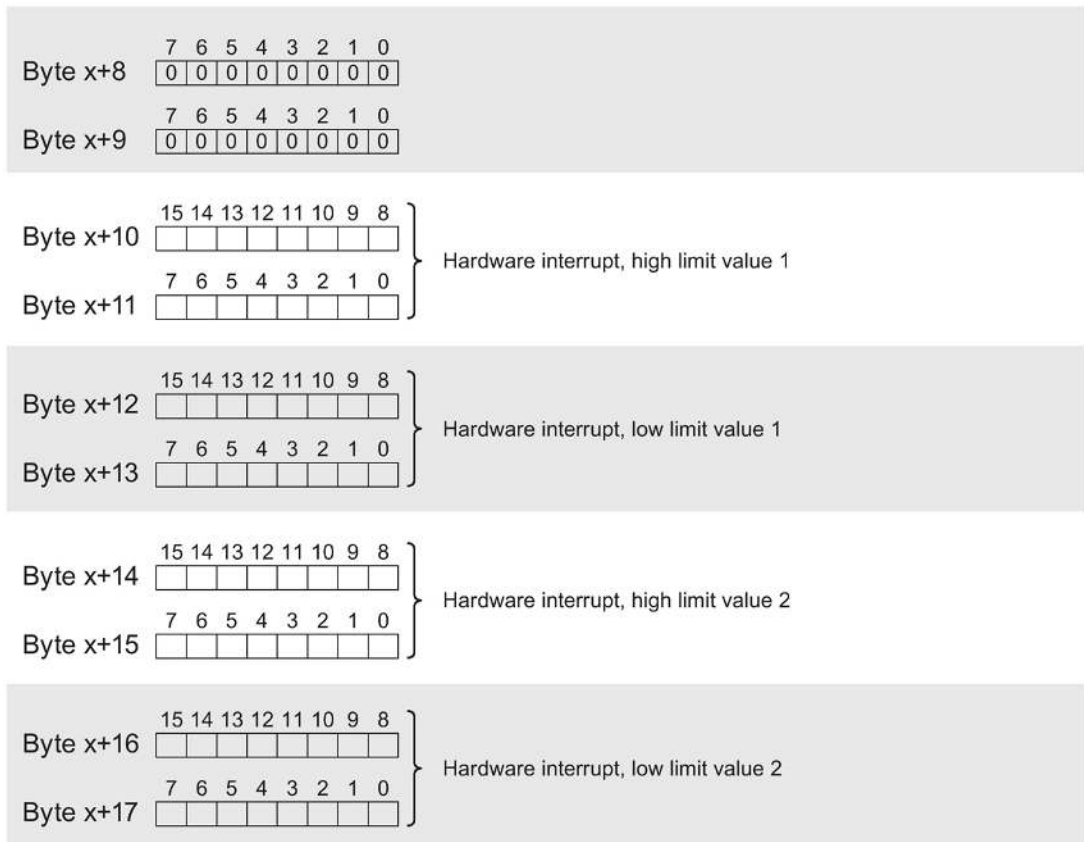

Figure A-5 Structure DS128 AI8 Byte x+7



A.2 Parameter assignment and structure of parameter data record

Figure A-6 Structure DS128 AI 4RTD TC 234wire x+17

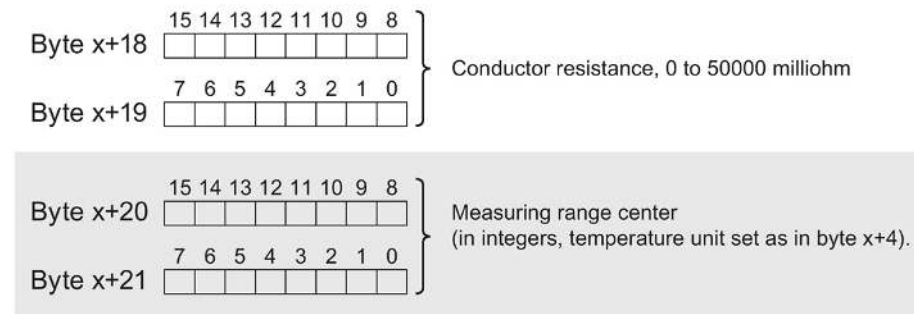

Figure A-7 Structure of byte x to x+21 for channel 0 to 7

Codes for measurement type

The following table contains the codes for the measurement types of the analog input module. You must enter these codes at byte x (see previous figure).

Table A-3 Codes for measurement type

Measurement type	Code
Deactivated	0000 0000
Voltage	0000 0001
Resistor, 2-wire connection	0000 0110
Thermal resistor, 2-wire connection	0000 1001
Thermocouple	0000 1010

Codes for measuring range

The following table contains the codes for the measuring ranges of the analog input module. You must enter these codes at byte x+1 (see previous figure).

Table A-4 Codes for measuring range

Measuring range	Code
Voltage	
50 mV	0000 0001
80 mV	0000 0010
250 mV	0000 0011
1 V	0000 0101
Resistor	
150 Ω	0000 0001
300 Ω	0000 0010
600 Ω	0000 0011
3 k Ω	0000 0100
6 k Ω	0000 0101
PTC	0000 1111
Thermal resistor climatic	
Pt 100	0000 0000
Pt 200	0000 0111
Pt 500	0000 1000
Pt 1000	0000 1001
Thermal resistor standard	
Pt 100	0000 0010
Pt 200	0000 1011
Pt 500	0000 0100
Pt 1000	0000 0101
Thermal resistor climatic	
Ni 100	0000 0001
Ni 120	0000 1101
Ni 200	0001 0001
Ni 500	0001 0011
Ni 1000	0000 1010
Thermal resistor standard	
Ni 100	0000 0011
Ni 120	0000 1100
Ni 200	0001 0000
Ni 500	0001 0010
Ni 1000	0000 0110

A.2 Parameter assignment and structure of parameter data record

Measuring range	Code
Thermal resistor	
LG Ni 1000 climatic	0001 1101
LG Ni 1000 standard	0001 1100
Thermocouple	
Type B	0000 0000
Type N	0000 0001
Type E	0000 0010
Type R	0000 0011
Type S	0000 0100
Type J	0000 0101
Type L	0000 0110
Type T	0000 0111
Type K	0000 1000
Type U	0000 1001
Type C	0000 1010
Type TXK	0000 1011

Codes for temperature coefficient

The following table contains the codes for the temperature coefficients of the analog input module. You must enter these codes at byte x+2 (see previous figure).

Table A- 5 Codes for temperature coefficient for temperature measurement

Temperature coefficient	Code
Pt 0.00385055	0000 0000
Pt 0.003916	0000 0001
Pt 0.003902	0000 0010
Pt 0.00392	0000 0011
Pt 0.00385	0000 0100
Ni 0.00618	0000 1000
Ni 0.00672	0000 1001
LG-Ni 0.005	0000 1010

Limits for hardware interrupts

The following tables contain the permitted limits for hardware interrupts (in each case, the usable value is given). The limits depend on the selected measurement type and the selected measuring range. The value for the overflow must be larger than the value for the underflow. The limits are specified as decimal values. The conversion to the respective temperature unit is (1 digit = 0.1) for the standard range and (1 digit = 0.01) for the climate range, see section Representation of analog values (Page 75).

Table A-6 Limits for resistor and voltage

Resistor (all possible measuring range settings)	Voltage	
32510	32510	Overflow
1	-32511	Underflow

Table A-7 Limits for thermocouple types B, C, and E

Thermocouple									
Type B			Type C			Type E			
°C	°F	K	°C	°F	K	°C	°F	K	
20699	32765	23431	24999	32765	27731	11999	21919	14731	Overflow
-1199	-1839	1533	-1199	-1839	1533	-2699	-4539	33	Underflow

Table A-8 Limits for thermocouple types R, S, J, and L

Thermocouple									
Types R, S			Type J			Type L			
°C	°F	K	°C	°F	K	°C	°F	K	
20189	32765	22921	14499	26419	17231	11499	21019	14231	Overflow
-1699	-2739	1033	-2099	-3459	633	-1999	-3279	733	Underflow

Table A-9 Limits for thermocouple types T, K, and U

Thermocouple									
Type T			Type K			Type U			
°C	°F	K	°C	°F	K	°C	°F	K	
5399	10039	8131	16219	29515	18951	8499	15619	11231	Overflow
-2699	-4539	33	-2699	-4539	33	-1999	-3279	733	Underflow

A.2 Parameter assignment and structure of parameter data record

Table A- 10 Limits for thermocouple types N and TXK

Thermocouple						
Type N			Type TXK			
°C	°F	K	°C	°F	K	
15499	28219	18231	10499	19219	13231	Overflow
-2699	-4539	33	-1999	-3279	733	Underflow

Table A- 11 Limits for thermal resistor

Thermal resistor						
	Standard			Climatic		
	°C	°F	K	°C	°F	
Pt	9999	18319	12731	15499	31099	Overflow
	-2429	-4053	303	-14499	-22899	Underflow
Ni, Ni-LG	2949	5629	5681	29499	32765	Overflow
	-1049	-1569	1683	-10499	-15699	Underflow

A.3 Errors when transferring the data record

Error transferring the data record

The module always checks all values of the data record to be sent. The module applies the values from the data record only when all values have been transmitted without errors.

The WRREC instruction for writing data records returns corresponding error codes when errors occur in the STATUS parameter, see also the description of the "STATUS" parameter in the STEP 7 online help).

The following table shows the module-specific error codes and their meaning for parameter data record 128.

Error code in STATUS parameter (hexadecimal)				Meaning	Solution
Byte 0	Byte 1	Byte 2	Byte 3		
DF	80	B0	xx	Number of the data record unknown.	Enter a valid number for the data record.
DF	80	B1	xx	Length of the data record incorrect.	Enter a valid value for the data record length.
DF	80	B2	xx	Slot invalid or cannot be accessed.	<ul style="list-style-type: none"> • Check the station to determine whether the module is plugged or pulled. • Check the assigned values for the parameters of the WRREC instruction.
DF	80	E0	xx	Wrong version or error in the header information.	Correct the version, length and number of parameter blocks.
DF	80	E1	xx	Parameter error	Check the parameters of the module.

A.4 Switchable wire break check

Function

The "Switchable wire break check" is available for thermocouples. It switches off the wire break check for the module.

This is required, for example, to calibrate thermocouples, since the test current necessary for a wire break check leads to measurement errors during calibration.

The function has no effect on channels that are not assigned in the thermocouple mode.

Note

Startup and parameter reassignment

The wire break check is switched on again at each startup and during any parameter reassignment of the module.

Switch-off via the user program

You can deactivate the wire break check using data record 237.

Table A- 12 Structure of data record 237, switchable wire break check

Byte	Function	Format	Value	Description
0	Command	UBYTE	80 _H	Wire break check
1	Identifier	UBYTE	00 _H	Not relevant
2	Channel number	UBYTE	FF _H	All channels
3	Calibration step	UBYTE	FF _H	First triggering
4	Measurement type	UBYTE	00 _H	Not relevant
5	Measuring range	UBYTE	00 _H	Not relevant
6	Action	UBYTE	01 _H	Deactivate wire break check
			02 _H	Activate wire break check
7...17	Reserved	UBYTE	00 _H	Not relevant

Representation of analog values

This appendix shows the analog values for all measuring ranges supported by the analog input module AI 8xRTD/TC 2-wire HF.

Measured value resolution

The resolution of the analog values differs depending on the analog module and its parameter assignment.

Each analog value is written left aligned to the tags. The bits marked with "x" are set to "0".

Note

Temperature values

The digitized temperature values are the result of a conversion in the analog module. The following resolution therefore does not apply to temperature values.

Table B- 1 Resolution of the analog values

Resolution in bits including sign	Values		Analog value	
	Decimal	Hexadecimal	High byte	Low byte
14	4	4H	Sign 0 0 0 0 0 0 0	0 0 0 0 0 1 x x
15	2	2H	Sign 0 0 0 0 0 0 0	0 0 0 0 0 0 1 x
16	1	1H	Sign 0 0 0 0 0 0 0	0 0 0 0 0 0 0 1

B.1 Measured values for wire break and reference channel mode

Measured values for wire break

Table B-2 Measured values for a wire break as a function of enabled diagnostic information in RTD and TC operating modes

Programmable diagnostics		Measured value		Explanation
Wire break	Underflow			
Enable	*	32767	7FFF _H	The "wire break" diagnostics is reported.
Disable	*	32767	7FFF _H	No diagnostics reported. A wire-break check is carried out (i.e. test current flows).
Disable ¹	*	Undefined		No "wire break" diagnostics is reported. No wire-break check is carried out (i.e. no test current flows). This is required to calibrate thermocouples, since the measuring current necessary for a wire-break check leads to measurement errors during calibration.

* Parameter assignment not relevant

¹ The wire-break check can only be disabled via data set 237.

Table B-3 Measured values in case of a line break in a TC measurement with enabled reference junction (reference channel) depending on enabled diagnostic information

Case	Programmable diagnostics				Measured value			
	Reference channel		TC channel		Reference channel		TC channel	
	Wire break	Underflow	Wire break	Underflow				
1	Enable ³	* ³	*	* ²	32767 ³	7FFF _H ³	32767 ⁴	7FFF _H ⁴
2	Disable ³	* ³	*	* ²	32767 ³	7FFF _H ³	32767 ⁴	7FFF _H ⁴
3	*	*	Enable ³	* ³	Valid	Valid	32767 ³	7FFF _H ³
4	*	*	Disable ³	* ³	Valid	Valid	32767 ³	7FFF _H ³
5	*	*	Disable ^{1,3}	* ³	Valid	Valid	Undefined	

* Parameter assignment not relevant

¹ The wire-break check can only be disabled via data set 237.

² Diagnostics is suppressed in the event of a reference channel error.

³ Channel with line break

⁴ Measured value taken from the reference channel

Explanations of the cases:

Case	Reference channel	TC channel
1	The "wire break" diagnostics is reported. This has a higher priority than the "Underflow" diagnostics.*	The "Reference channel error" diagnostics is reported if this is enabled. Where own pending diagnostic information ("overflow" or "underflow") is reported as outgoing. Wire break diagnostics is detected independently of the measured value and has the same priority as the "Reference channel error" diagnostics. Both items of diagnostic information can be pending simultaneously. The measured value of the reference channel (RTD channel) is adopted for the TC channel. The validity of the measured value of the TC channel is irrelevant.
2	No diagnostics reported. A wire-break check is carried out (i.e. test current flows).*	<i>Behavior corresponds to case 1.</i>
3	<i>Measured values are in the valid measuring range</i>	The "wire break" diagnostics is reported.*
4	<i>Measured values are in the valid measuring range</i>	No diagnostics reported. A wire-break check is carried out (i.e. test current flows).*
5	<i>Measured values are in the valid measuring range</i>	No "wire break" diagnostics is reported. No wire-break check is carried out (i.e. no test current flows). This is required to calibrate thermocouples, since the measuring current necessary for a wire-break check leads to measurement errors during calibration.*

* Channel with wire break

B.2 Representation of input ranges

In the following tables, you can find the digitized representation of the bipolar and unipolar input ranges. The resolution is 16 bits.

Table B- 4 Bipolar input ranges

Dec. value	Measured value in %	Data word																Range
		2 ¹⁵	2 ¹⁴	2 ¹³	2 ¹²	2 ¹¹	2 ¹⁰	2 ⁹	2 ⁸	2 ⁷	2 ⁶	2 ⁵	2 ⁴	2 ³	2 ²	2 ¹	2 ⁰	
32767	>117.589	0	1	1	1	1	1	1	1	1	1	1	1	1	1	1	1	Overflow
32511	117.589	0	1	1	1	1	1	1	0	1	1	1	1	1	1	1	1	Overrange
27649	100.004	0	1	1	0	1	1	0	0	0	0	0	0	0	0	0	1	
27648	100.000	0	1	1	0	1	1	0	0	0	0	0	0	0	0	0	0	Nominal range
1	0.003617	0	0	0	0	0	0	0	0	0	0	0	0	0	0	0	1	
0	0.000	0	0	0	0	0	0	0	0	0	0	0	0	0	0	0	0	
-1	-0.003617	1	1	1	1	1	1	1	1	1	1	1	1	1	1	1	1	
-27648	-100.000	1	0	0	1	0	1	0	0	0	0	0	0	0	0	0	0	Underrange
-27649	-100.004	1	0	0	1	0	0	1	1	1	1	1	1	1	1	1	1	
-32512	-117.593	1	0	0	0	0	0	0	1	0	0	0	0	0	0	0	0	Underflow
-32768	<-117.593	1	0	0	0	0	0	0	0	0	0	0	0	0	0	0	0	

Table B- 5 Unipolar input ranges

Dec. value	Measured value in %	Data word																Range
		2 ¹⁵	2 ¹⁴	2 ¹³	2 ¹²	2 ¹¹	2 ¹⁰	2 ⁹	2 ⁸	2 ⁷	2 ⁶	2 ⁵	2 ⁴	2 ³	2 ²	2 ¹	2 ⁰	
32767	>117.589	0	1	1	1	1	1	1	1	1	1	1	1	1	1	1	1	Overflow
32511	117.589	0	1	1	1	1	1	1	0	1	1	1	1	1	1	1	1	Overrange
27649	100.004	0	1	1	0	1	1	0	0	0	0	0	0	0	0	0	1	
27648	100.000	0	1	1	0	1	1	0	0	0	0	0	0	0	0	0	0	Nominal range
1	0.003617	0	0	0	0	0	0	0	0	0	0	0	0	0	0	0	1	
0	0.000	0	0	0	0	0	0	0	0	0	0	0	0	0	0	0	0	
-1	-0.003617	1	1	1	1	1	1	1	1	1	1	1	1	1	1	1	1	
-4864	-17.593	1	1	1	0	1	1	0	1	0	0	0	0	0	0	0	0	Underrange
-32768	<-17.593	1	0	0	0	0	0	0	0	0	0	0	0	0	0	0	0	

B.3 Representation of analog values in voltage measuring ranges

The following tables list the decimal and hexadecimal values (codes) of the possible voltage measuring ranges.

Table B- 6 Voltage measuring range ± 1 V

Values		Voltage measuring range		Range
Dec.	Hex.	± 1 V		
32767	7FFF	> 1.176 V		Overflow
32511	7EFF	1.176 V		Overrange
27649	6C01			
27648	6C00	1 V		Nominal range
20736	5100	0.75 V		
1	1	36.17 μ V		
0	0	0 V		
-1	FFFF			
-20736	AF00	-0.75 V		
-27648	9400	-1 V		Underrange
-27649	93FF			
-32512	8100	-1.176 V		
-32768	8000	<-1.176 V		

Table B- 7 Voltage measuring range ± 500 mV to ± 50 mV

Values		Voltage measuring range			Range
Dec.	Hex.	± 250 mV	± 80 mV	± 50 mV	
32767	7FFF	> 294.0 mV	> 94.1 mV	> 58.8 mV	Overflow
32511	7EFF	294.0 mV	94.1 mV	58.8 mV	Overrange
27649	6C01				
27648	6C00	250 mV	80 mV	50 mV	Nominal range
20736	5100	187.5 mV	60 mV	37.5 mA	
1	1	9.04 μ V	2.89 μ V	1.81 μ V	
0	0	0 mV	0 mV	0 mV	
-1	FFFF				
-20736	AF00	-187.5 mV	-60 mV	-37.5 mV	
-27648	9400	-250 mV	-80 mV	-50 mV	Underrange
-27649	93FF				
-32512	8100	-294.0 mV	-94.1 mV	-58.8 mV	
-32768	8000	<-294.0 mV	<-94.1 mV	<-58.8 mV	

B.4 Representation of analog values for resistance-type sensors

The following tables list the decimal and hexadecimal values (codes) of the possible resistance-type sensors.

Table B- 8 Resistance-type sensors from 150 Ω to 6000 Ω

Values		Resistance-type sensor range					Range
Dec.	Hex.	150 Ω	300 Ω	600 Ω	3000 Ω	6000 Ω	
32767	7FFF	> 176.38 Ω	> 352.77 Ω	> 705.53 Ω	> 3527.7 Ω	> 7055.3 Ω	Overflow
32511	7EFF	176.38 Ω	352.77 Ω	705.53 Ω	3527.7 Ω	7055.3 Ω	Overrange
27649	6C01						
27648	6C00	150 Ω	300 Ω	600 Ω	3000 Ω	6000 Ω	Nominal range
20736	5100	112.5 Ω	225 Ω	450 Ω	2250 Ω	4500 Ω	
1	1	5.43 m Ω	10.85 m Ω	21.70 m Ω	108.5 m Ω	217 m Ω	
0	0	0 Ω	0 Ω	0 Ω	0 Ω	0 Ω	
-32768	8000	(negative values are physically impossible)					Underflow ¹

¹ If the resistors are not connected correctly or the conductor resistance is too high

B.5 Representation of analog values for thermal resistors

Note

A higher resolution can be configured for the measuring range for the standard thermal resistors, see section Scalable measuring range (Page 37).

The tables below list the decimal and hexadecimal values (codes) of the thermal resistors.

Table B-9 Thermal resistor Pt 100, 200, 500, 1000 standard

Pt x00 standard in °C (1 digit = 0.1 °C)	Values		Pt x00 standard in °F (1 digit = 0.1 °F)	Values		Pt x00 standard in K (1 digit = 0.1 K)	Values		Range
	Dec.	Hex.		Dec.	Hex.		Dec.	Hex.	
> 1000.0	32767	7FFF	> 1832.0	32767	7FFF	> 1273.2	32767	7FFF	Overflow
1000.0	10000	2710	1832.0	18320	4790	1273.2	12732	31BC	Overrange
:	:	:	:	:	:	:	:	:	
850.1	8501	2135	1562.1	15621	3D05	1123.3	11233	2BE1	
850.0	8500	2134	1562.0	15620	3D04	1123.2	11232	2BE0	Nominal range
:	:	:	:	:	:	:	:	:	
-200.0	-2000	F830	-328.0	-3280	F330	73.2	732	2DC	
-200.1	-2001	F82F	-328.1	-3281	F32F	73.1	731	2DB	Underrange
:	:	:	:	:	:	:	:	:	
-243.0	-2430	F682	-405.4	-4054	F02A	30.2	302	12E	
< -243.0	-32768	8000	< -405.4	-32768	8000	< 30.2	32768	8000	Underflow

Table B-10 Thermal resistor Pt 100, 200, 500, 1000 climatic

Pt x00 climatic in °C (1 digit = 0.01 °C)	Values		Pt x00 climatic in °F (1 digit = 0.01 °F)	Values		Range
	Dec.	Hex.		Dec.	Hex.	
> 155.00	32767	7FFF	> 311.00	32767	7FFF	Overflow
155.00	15500	3C8C	311.00	31100	797C	Overrange
:	:	:	:	:	:	
130.01	13001	32C9	266.01	26601	67E9	
130.00	13000	32C8	266.00	26600	67E8	Nominal range
:	:	:	:	:	:	
-120.00	-12000	D120	-184.00	-18400	B820	
-120.01	-12001	D11F	-184.01	-18401	B81F	Underrange
:	:	:	:	:	:	
-145.00	-14500	C75C	-229.00	-22900	A68C	
< -145.00	-32768	8000	< -229.00	-32768	8000	Underflow

Representation of analog values

B.5 Representation of analog values for thermal resistors

Table B- 11 Thermal resistor Ni 100, 120, 200, 500, 1000, LG-Ni 1000 standard

Ni x00 standard in °C (1 digit = 0.1 °C)	Values		Ni x00 standard in °F (1 digit = 0.1 °F)	Values		Ni x00 standard in K (1 digit = 0.1 K)	Values		Range
	Dec.	Hex.		Dec.	Hex.		Dec.	Hex.	
> 295.0	32767	7FFF	> 563.0	32767	7FFF	> 568.2	32767	7FFF	Overflow
295.0	2950	B86	563.0	5630	15FE	568.2	5682	1632	Overrange
:	:	:	:	:	:	:	:	:	
250.1	2501	9C5	482.1	4821	12D5	523.3	5233	1471	Nominal range
250.0	2500	9C4	482.0	4820	12D4	523.2	5232	1470	
:	:	:	:	:	:	:	:	:	Underrange
-60.0	-600	FDA8	-76.0	-760	FD08	213.2	2132	854	
-60.1	-601	FDA7	-76.1	-761	FD07	213.1	2131	853	Underflow
:	:	:	:	:	:	:	:	:	
-105.0	-1050	FBE6	-157.0	-1570	F9DE	168.2	1682	692	
< -105.0	-32768	8000	< -157.0	-32768	8000	< 168.2	32768	8000	

Table B- 12 Thermal resistor Ni 100, 120, 200, 500, 1000, LG-Ni 1000 climatic

Ni x00 climatic in °C (1 digit = 0.01 °C)	Values		Ni x00 climatic in °F (1 digit = 0.01 °F)	Values		Range
	Dec.	Hex.		Dec.	Hex.	
> 295.00	32767	7FFF	> 327.66	32767	7FFF	Overflow
295.00	29500	733C	327.66	32766	7FFE	Overrange
:	:	:	:	:	:	
250.01	25001	61A9	280.01	28001	6D61	Nominal range
250.00	25000	61A8	280.00	28000	6D60	
:	:	:	:	:	:	Underrange
-60.00	-6000	E890	-76.00	-7600	E250	
-60.01	-6001	E88F	-76.01	-7601	E24F	Underflow
:	:	:	:	:	:	
-105.00	-10500	D6FC	-157.00	-15700	C2AC	
< - 105.00	-32768	8000	< - 157.00	-32768	8000	

B.6 Representation of analog values for thermocouples

Note

A higher resolution can be configured for thermocouples, see section Scalable measuring range (Page 37).

The tables below list the decimal and hexadecimal values (codes) of the thermocouples.

Table B- 13 Thermocouple type B

Type B in °C	Values		Type B in °F	Values		Type B in K	Values		Range
	Dec.	Hex.		Dec.	Hex.		Dec.	Hex.	
> 2070.0	32767	7FFF	> 3276.6	32767	7FFF	> 2343.2	32767	7FFF	Overflow
2070.0	20700	50DC	3276.6	32766	7FFE	2343.2	23432	5B88	Overrange
:	:	:	:	:	:	:	:	:	
1820.1	18201	4719	2786.6	27866	6CDA	2093.3	20933	51C5	Nominal range
1820.0	18200	4718	2786.5	27865	6CD9	2093.2	20932	51C4	
:	:	:	:	:	:	:	:	:	
0.0	0	0000	32.0	320	0140	273.2	2732	0AAC	Underrange
-0.1	-1	FFFF	31.9	319	013F	273.1	2731	0AAB	
:	:	:	:	:	:	:	:	:	
-120.0	-1200	FB50	-184.0	-1840	F8D0	153.2	1532	05FC	Underflow
< -120.0	-32768	8000	< -184.0	-32768	8000	< 153.2	-32768	8000	

Table B- 14 Thermocouple type C

Type C in °C	Values		Type C in °F	Values		Type C in K	Values		Range
	Dec.	Hex.		Dec.	Hex.		Dec.	Hex.	
> 2500.0	32767	7FFF	> 3276.6	32767	7FFF	> 2773.2	32767	7FFF	Overflow
2500.0	25000	61A8	3276.6	32766	7FFE	2773.2	27732	6C54	Overrange
:	:	:	:	:	:	:	:	:	
2315.1	23151	5A6F	2786.6	27866	6CDA	2588.3	25883	651B	Nominal range
2315.0	23150	5A6E	2786.5	27865	6CD9	2588.2	25882	651A	
:	:	:	:	:	:	:	:	:	
0.0	0	0000	32.0	320	0140	273.2	2732	0AAC	Underrange
-0.1	-1	FFFF	31.9	319	013F	273.1	2731	0AAB	
:	:	:	:	:	:	:	:	:	
-120.0	-1200	FB50	-184.0	-1840	F8D0	153.2	1532	05FC	Underflow
< -120.0	-32768	8000	< -184.0	-32768	8000	< 153.2	-32768	8000	

Representation of analog values

B.6 Representation of analog values for thermocouples

Table B- 15 Thermocouple type E

Type E in °C	Values		Type E in °F	Values		Type E in K	Values		Range
	Dec.	Hex.		Dec.	Hex.		Dec.	Hex.	
> 1200.0	32767	7FFF	> 2192.0	32767	7FFF	> 1473.2	32767	7FFF	Overflow
1200.0	12000	2EE0	2192.0	21920	55A0	1473.2	14732	398C	Overrange
:	:	:	:	:	:	:	:	:	
1000.1	10001	2711	1832.1	18321	4791	1273.3	12733	31BD	
1000.0	10000	2710	1832.0	18320	4790	1273.2	12732	31BC	Nominal range
:	:	:	:	:	:	:	:	:	
-270.0	-2700	F574	-454.0	-4540	EE44	3.2	32	0020	
< -270.0	-32768	8000	< -454.0	-32768	8000	< 3.2	-32768	8000	Underflow

Table B- 16 Thermocouple type J

Type J in °C	Values		Type J in °F	Values		Type J in K	Values		Range
	Dec.	Hex.		Dec.	Hex.		Dec.	Hex.	
> 1450.0	32767	7FFF	> 2642.0	32767	7FFF	> 1723.2	32767	7FFF	Overflow
1450.0	14500	38A4	2642.0	26420	6734	1723.2	17232	4350	Overrange
:	:	:	:	:	:	:	:	:	
1200.1	12001	2EE1	2192.1	21921	55A1	1473.3	14733	398D	
1200.0	12000	2EE0	2192.0	21920	55A0	1473.2	14732	398C	Nominal range
:	:	:	:	:	:	:	:	:	
-210.0	-2100	F7CC	-346.0	-3460	F27C	63.2	632	0278	
< -210.0	-32768	8000	< -346.0	-32768	8000	< 63.2	-32768	8000	Underflow

Table B- 17 Thermocouple type K

Type K in °C	Values		Type K in °F	Values		Type K in K	Values		Range
	Dec.	Hex.		Dec.	Hex.		Dec.	Hex.	
> 1622.0	32767	7FFF	> 2951.6	32767	7FFF	> 1895.2	32767	7FFF	Overflow
1622.0	16220	3F5C	2951.6	29516	734C	1895.2	18952	4A08	Overrange
:	:	:	:	:	:	:	:	:	
1372.1	13721	3599	2501.7	25017	61B9	1645.3	16453	4045	
1372.0	13720	3598	2501.6	25016	61B8	1645.2	16452	4044	Nominal range
:	:	:	:	:	:	:	:	:	
-270.0	-2700	F574	-454.0	-4540	EE44	3.2	32	0020	
< -270.0	-32768	8000	< -454.0	-32768	8000	< 3.2	-32768	8000	Underflow

Table B- 18 Thermocouple type L

Type L in °C	Values		Type L in °F	Values		Type L in K	Values		Range
	Dec.	Hex.		Dec.	Hex.		Dec.	Hex.	
> 1150.0	32767	7FFF	> 2102.0	32767	7FFF	> 1423.2	32767	7FFF	Overflow
1150.0	11500	2CEC	2102.0	21020	521C	1423.2	14232	3798	Overrange
:	:	:	:	:	:	:	:	:	
900.1	9001	2329	1652.1	16521	4089	1173.3	11733	2DD5	
900.0	9000	2328	1652.0	16520	4088	1173.2	11732	2DD4	Nominal range
:	:	:	:	:	:	:	:	:	
-200.0	-2000	F830	-328.0	-3280	F330	73.2	732	02DC	
< -200.0	-32768	8000	< -328.0	-32768	8000	< 73.2	-32768	8000	Underflow

Table B- 19 Thermocouple type N

Type N in °C	Values		Type N in °F	Values		Type N in K	Values		Range
	Dec.	Hex.		Dec.	Hex.		Dec.	Hex.	
> 1550.0	32767	7FFF	> 2822.0	32767	7FFF	> 1823.2	32767	7FFF	Overflow
1550.0	15500	3C8C	2822.0	28220	6E3C	1823.2	18232	4738	Overrange
:	:	:	:	:	:	:	:	:	
1300.1	13001	32C9	2372.1	23721	5CA9	1573.3	15733	3D75	
1300.0	13000	32C8	2372.0	23720	5CA8	1573.2	15732	3D74	Nominal range
:	:	:	:	:	:	:	:	:	
-270.0	-2700	F574	-454.0	-4540	EE44	3.2	32	0020	
< -270.0	-32768	8000	< -454.0	-32768	8000	< 3.2	-32768	8000	Underflow

Table B- 20 Thermocouples R and S

Types R, S in °C	Values		Types R, S in °F	Values		Types R, S in K	Values		Range
	Dec.	Hex.		Dec.	Hex.		Dec.	Hex.	
> 2019.0	32767	7FFF	> 3276.6	32767	7FFF	> 2292.2	32767	7FFF	Overflow
2019.0	20190	4EDE	3276.6	32766	7FFE	2292.2	22922	598A	Overrange
:	:	:	:	:	:	:	:	:	
1769.1	17691	451B	3216.3	32163	7DA3	2042.3	20423	4FC7	
1769.0	17690	451A	3216.2	32162	7DA2	2042.2	20422	4FC6	Nominal range
:	:	:	:	:	:	:	:	:	
-50.0	-500	FE0C	-58.0	-580	FDBC	223.2	2232	08B8	
-50.1	-501	FE0B	-58.1	-581	FDBB	223.1	2231	08B7	Underrange
:	:	:	:	:	:	:	:	:	
-170.0	-1700	F95C	-274.0	-2740	F54C	103.2	1032	0408	
< -170.0	-32768	8000	< -274.0	-32768	8000	< 103.2	< 1032	8000	Underflow

Representation of analog values

B.6 Representation of analog values for thermocouples

Table B- 21 Thermocouple type T

Type T in °C	Values		Type T in °F	Values		Type T in K	Values		Range
	Dec.	Hex.		Dec.	Hex.		Dec.	Hex.	
> 540.0	32767	7FFF	> 1004.0	32767	7FFF	> 813.2	32767	7FFF	Overflow
540.0	5400	1518	1004.0	10040	2738	813.2	8132	1FC4	Overrange
:	:	:	:	:	:	:	:	:	
400.1	4001	0FA1	752.1	7521	1D61	673.3	6733	1AAD	
400.0	4000	0FA0	752.0	7520	1D60	673.2	6732	1AAC	Nominal range
:	:	:	:	:	:	:	:	:	
-270.0	-2700	F574	-454.0	-4540	EE44	3.2	32	0020	
< -270.0	-32768	8000	< -454.0	-32768	8000	< 3.2	-32768	8000	Underflow

Table B- 22 Thermocouple type U

Type U in °C	Values		Type U in °F	Values		Type U in K	Values		Range
	Dec.	Hex.		Dec.	Hex.		Dec.	Hex.	
> 850.0	32767	7FFF	> 1562.0	32767	7FFF	> 1123.2	32767	7FFF	Overflow
850.0	8500	2134	1562.0	15620	2738.0	1123.2	11232	2BE0	Overrange
:	:	:	:	:	:	:	:	:	
600.1	6001	1771	1112.1	11121	2B71	873.3	8733	221D	
600.0	6000	1770	1112.0	11120	2B70	873.2	8732	221C	Nominal range
:	:	:	:	:	:	:	:	:	
-200.0	-2000	F830	-328.0	-3280	F330	73.2	732	02DC	
< -200.0	-32768	8000	< -328.0	-32768	8000	< 73.2	-32768	8000	Underflow

Table B- 23 Thermocouple type TXK (GOST)

Type TXK in °C	Values		Type TXK in °F	Values		Type TXK in K	Values		Range
	Dec.	Hex.		Dec.	Hex.		Dec.	Hex.	
> 1050.0	32767	7FFF	> 1922.0	32767	7FFF	>1323.2	32767	7FFF	Overflow
1050.0	10500	2904	1922.0	19220	4B14	1323.2	13232	33B0	Overrange
:	:	:	:	:	:	:	:	:	
800.1	8001	1F41	1472.1	14721	3981	1073.3	10733	29ED	
800.0	8000	1F40	1472.0	14720	3980	1073.2	10732	29EC	Nominal range
:	:	:	:	:	:	:	:	:	
0.0	0	0000	32.0	320	0140	273	2730	0AAA	
:	:	:	:	:	:	:	:	:	
-200.0	-2000	F830	-328.0	-3280	F330	73.2	732	02DC	
< -200.0	-32768	8000	< -328.0	-32768	8000	<73.2	-32768	8000	Underflow