



Questo manuale d'istruzione è fornito da trovaprezzi.it. Scopri tutte le offerte per [Sony E 15mm F1.4 G Sony](#)
E o cerca il tuo prodotto tra le [migliori offerte di Obiettivi per Fotocamere](#)



Questo manuale d'istruzione è fornito da trovaprezzi.it. Scopri tutte le offerte per [Sony E 15mm F1.4 G Sony](#)
E o cerca il tuo prodotto tra le [migliori offerte di Obiettivi per Fotocamere](#)

SONY®

5-028-667-01(1)

交換レンズ Interchangeable Lens Objectif interchangeable 可更换镜头

取扱説明書
Operating Instructions
Mode d'emploi
Manual de instrucciones
使用说明书



E 15mm
F1.4 G

E-mount

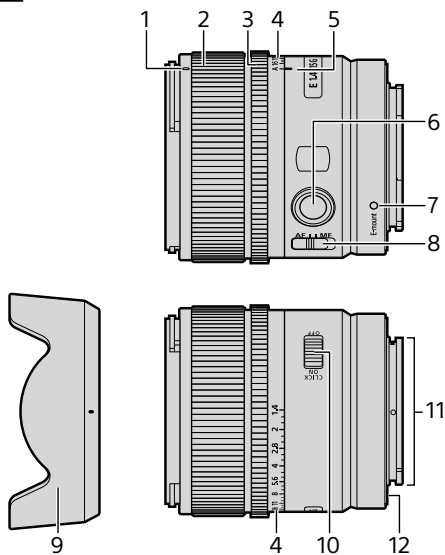
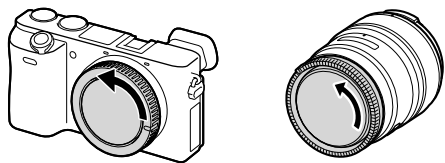
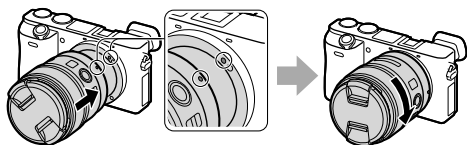
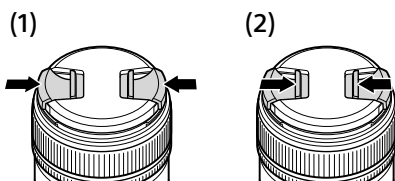

SEL15F14G

A**B****1-1****1-2****1-3**

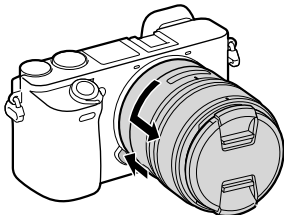
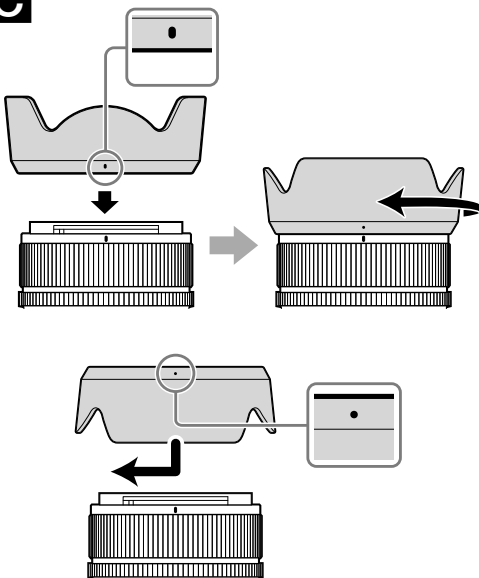
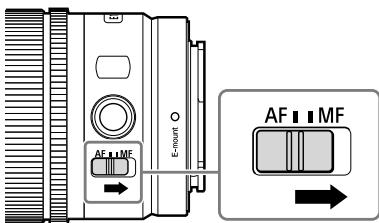
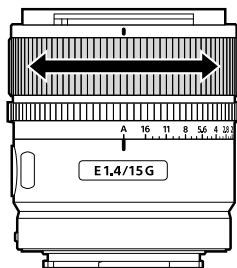
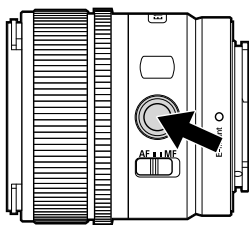
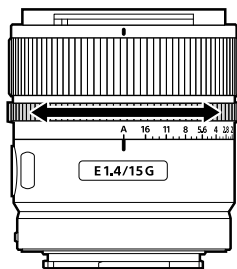
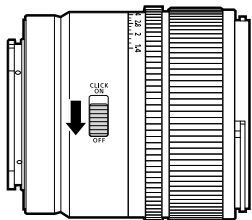
B**2****C****D****(1)****(2)****E****F****a**

This instruction manual explains how to use lenses. Precautions common to all lenses such as notes on use are found in the separate "Precautions before using". Be sure to read both documents before using your lens.

This lens is designed for Sony α camera system E-mount cameras. You cannot use it on A-mount cameras.

For further information on compatibility, visit the web site of Sony in your area, or consult your dealer of Sony or local authorized service facility of Sony.

For Customers in the U.S.A.

For question regarding your product or for the Sony Service Center nearest you, call 1-800-222-SONY (7669).

Supplier's Declaration of Conformity

Trade Name : SONY

Model : SEL15F14G

Responsible Party : Sony Electronics Inc.

Address : 16535 Via Esprillo, San Diego, CA 92127

U.S.A.

Telephone Number : 858-942-2230

This device complies with part 15 of the FCC rules.

Operation is subject to the following two conditions:

- (1) This device may not cause harmful interference, and (2) this device must accept any interference received, including interference that may cause undesired operation.

Notes on Use

- Do not leave the lens exposed to the sun or a bright light source. Internal malfunction of the camera body and lens, smoke, or a fire may result due to the effect of light focusing. If circumstances necessitate leaving the lens in sunlight, be sure to attach the lens caps. When shooting against the sun, keep the sun completely out of the angle of view.
- When carrying a camera with the lens attached, always firmly hold both the camera and the lens.
- This lens is not water-proof, although designed with dust-proofness and splash-proofness in mind. If using in the rain etc., keep water drops away from the lens.
- If the lens alone is shaken or if a camera with the lens attached is shaken while the camera is turned off, an internal component of the lens may rattle. This, however, does not indicate a malfunction. In addition, while you carry around the lens, your movement may cause the internal lens groups to shake. This, however, does not affect the performance of the lens groups.
- Using this unit with products from other manufacturers may affect its performance, leading to accidents or malfunction.

Precautions on using a flash

- With certain combinations of lens and flash, the lens may partially block the light of the flash, resulting in a shadow at the bottom of the picture. In such a case, adjust the focal length or the shooting distance before shooting.

Vignetting

- When using the lens, the corners of the screen become darker than the center. To reduce this phenomena (called vignetting), close the aperture by 1 to 2 stops.

A Identifying the Parts

- 1 Lens hood index
- 2 Focusing ring
- 3 Aperture ring
- 4 Aperture scale
- 5 Aperture index
- 6 Focus hold button
- 7 Mounting index
- 8 Focus mode switch
- 9 Lens hood
- 10 Aperture click switch
- 11 Lens contacts*
- 12 Lens mount rubber ring

* Do not touch the lens contacts.

B Attaching and Detaching the Lens

To attach the lens

(See illustration **B-1**.)

- 1** Remove the rear lens cap and the camera body cap.
- 2** Align the white index on the lens barrel with the white index on the camera (mounting index), then insert the lens into the camera mount and rotate it clockwise until it locks.
 - Do not press the lens release button on the camera when mounting the lens.
 - Do not mount the lens at an angle.
- 3** Remove the front lens cap.
 - You can attach/detach the front lens cap in two ways, (1) and (2). When you attach/detach the lens cap with the lens hood attached, use method (2).

To detach the lens

- 1** Attach the front lens cap.
- 2** While holding down the lens release button on the camera, rotate the lens counterclockwise until it stops, then detach the lens. (See illustration **B-2**.)

C Attaching the Lens Hood

It is recommended that you use a lens hood to reduce flare and ensure maximum image quality.

Align the red line on the lens hood with the red line on the lens (lens hood index), then insert the lens hood into the lens mount and rotate it clockwise until it clicks into place and the red dot on the lens hood is aligned with the red line on the lens.

- If the lens hood is not rotated until it clicks into place, there is a possibility that a shadow appears on captured images or the lens hood falls off.
- If the flash light is partially blocked by the lens hood, a shadow may appear at the bottom of captured images. In such a case, remove the lens hood.
- When storing, fit the lens hood onto the lens backwards.

D Focusing

- The focus mode switch of this lens does not function with some camera models.

For further information on compatibility, visit the web site of Sony in your area, or consult your dealer of Sony or local authorized service facility of Sony.

To switch AF (auto focus)/

MF (manual focus)

The focus mode can be switched between AF and MF on the lens.

For AF photography, both the camera and lens should be set to AF. For MF photography, either or both the camera or lens should be set to MF.

To set the focus mode on the lens

Slide the focus mode switch to the appropriate mode, AF or MF (1).

- Refer to the camera manuals to set the focus mode of the camera.
- In MF, turn the focusing ring to adjust the focus (2) while looking through the viewfinder, etc.

To use a camera equipped with an AF/MF control button

- By pressing the AF/MF control button during AF operation, you can temporarily switch to MF.
- Pressing the AF/MF control button during MF operation lets you temporarily switch to AF if the lens is set to AF and the camera to MF.

E Using the Focus Hold Buttons

- The focus hold button of this lens does not function with some camera models.

For further information on compatibility, visit the web site of Sony in your area, or consult your dealer of Sony or local authorized service facility of Sony.

Press the focus hold button in AF to cancel AF. The focus is fixed and you can release the shutter on the fixed focus. Release the focus hold button while pressing the shutter button halfway to start AF again.

F Adjusting the Aperture

When you align "A" on the aperture scale to the aperture index, the camera is set to auto iris mode and the exposure is set by the camera. And you can adjust the amount of light between f/1.4 and f/16 by rotating the aperture ring.

Notes

Set the aperture click switch to "OFF" when shooting movies. (See illustration **F-a**.)

When the aperture click switch is set to "OFF," the sound of the aperture ring is reduced. (For movie recording)

If you change the aperture value while shooting a movie with the aperture click switch set to "ON," the sound of the aperture ring will be recorded.

Specifications

Product name (Model name)	E 15mm F1.4 G (SEL15F14G)
Focal length (mm)	15
35mm equivalent focal length*1 (mm)	22.5
Lens groups-elements	12-13
Angle of view*2	87°
Minimum focus*3 (m (feet))	
Auto focus	0.2 (0.66)
Manual focus	0.17 (0.56)
Maximum magnification (X)	
Auto focus	0.12
Manual focus	0.15
Minimum aperture	f/16
Filter diameter (mm)	55
Dimensions (maximum diameter × height) (approx., mm (in.))	66.6 × 69.5 (2 5/8 × 2 3/4)
Mass (approx., g (oz))	219 (7.8)
SteadyShot	No

*1 This is the equivalent focal length in 35mm format when mounted on an Interchangeable Lens Digital Camera equipped with an APS-C sized image sensor.

*2 Angle of view is the value for Interchangeable Lens Digital Cameras equipped with an APS-C sized image sensor.

*3 Minimum focus is the distance from the image sensor to the subject.

- Depending on the lens mechanism, the focal length may change with any change in shooting distance. The focal lengths given above assume the lens is focused at infinity.

Included items

(The number in parentheses indicates the number of pieces.)

Lens (1), Front lens cap (1), Rear lens cap (1), Lens hood (1), Set of printed documentation

Design and specifications are subject to change without notice.

α and **G** are trademarks of Sony Group Corporation.



5028667011

<https://www.sony.net/>

©2021 Sony Corporation
Printed in China