

The Ramp Basin

Junior

Junior Ramp Basin 100 1200mm

Size: 1200 x 380 x 100mm

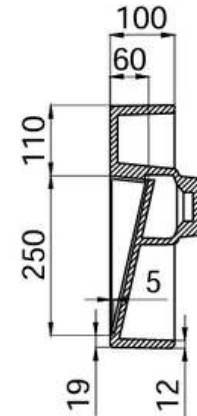
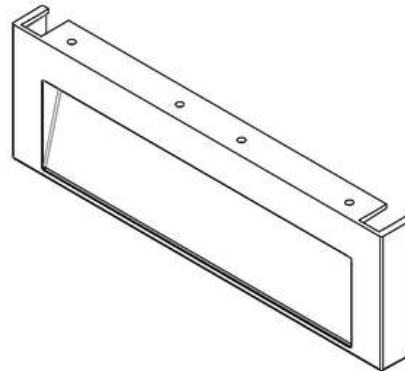
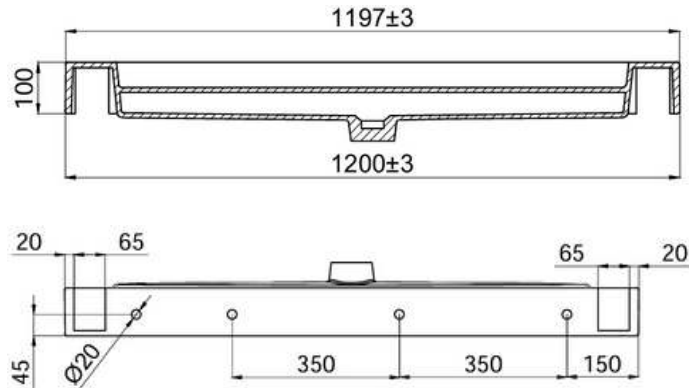
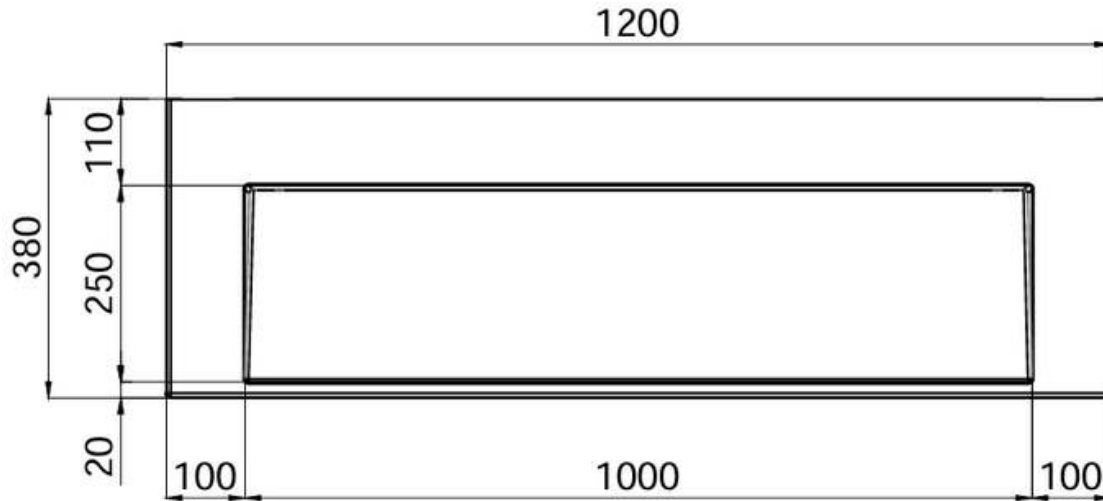

Net Weight: Approximately 35kg

Unit: mm (3mm tolerance)

Composition: Matte White Solid Surface 12mm/20mm

Upgrades & Additions:

- Matte white (Standard)
- Gloss finish
- Colour
- Tap hole or no tap hole
- Custom sizing
- Up to 3 wastes depending on basin length

Notes:

- 40mm waste
- Brackets and screws included
- 10 year manufacturers warranty

INTERNATIONAL
Phone: +61 1800 462 946
Email: info@therampbasinfactory.com
Web: www.therampbasinfactory.com

AUSTRALIA
Phone: 1800 462 946
Email: info@stonebaths.com.au
Web: www.stonebaths.com.au

NEW ZEALAND
Phone: 0800 001 872
Email: info@stonebaths.co.nz
Web: www.stonebaths.co.nz

Industry leaders since 2004

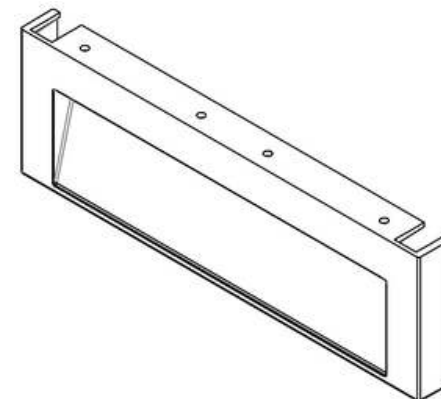
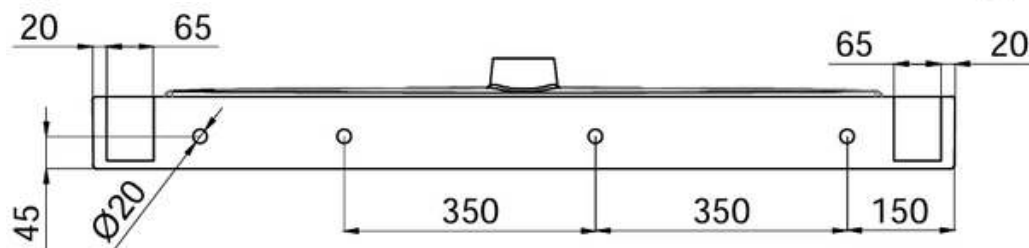
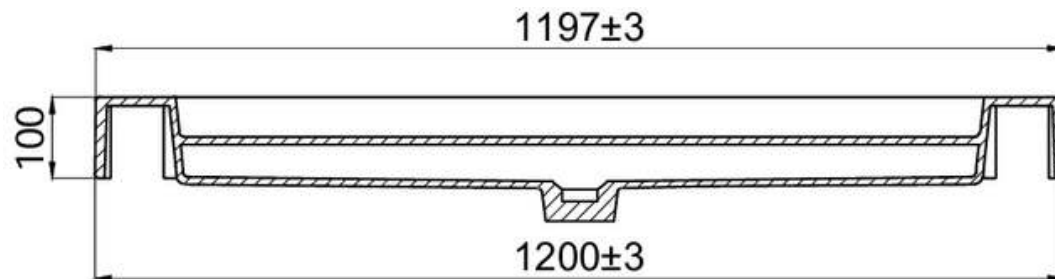
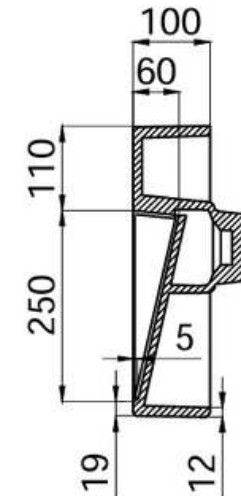
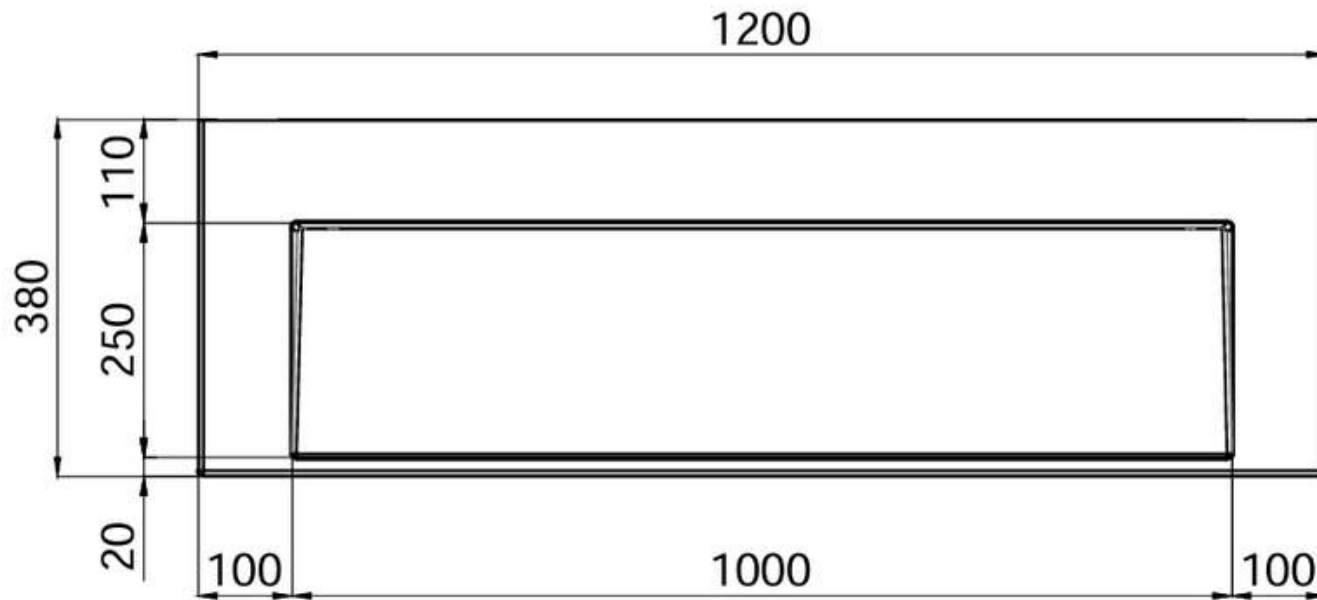

INTERNATIONAL
 Phone: +61 1800 462 946
 Email: info@therampbasinfactory.com
 Web: www.therampbasinfactory.com

AUSTRALIA
 Phone: 1800 462 946
 Email: info@stonebaths.com.au
 Web: www.stonebaths.com.au

NEW ZEALAND
 Phone: 0800 001 872
 Email: info@stonebaths.co.nz
 Web: www.stonebaths.co.nz

1. Prepare the tools and accessories

Tools required - Drill, level, pencil, screwdriver
Brackets, screws and fasteners included as pictured

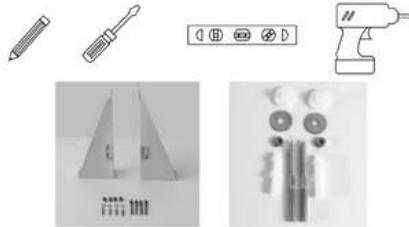

4. Secure the sink to the wall

Secure the sink to the wall with the mounting brackets and screws. Insert the first fastener and use a level to ensure the basin is straight. When the sink is properly aligned insert the remaining wall fasteners. Secure the basin with 4 fasteners for basins up to 1500mm. Longer basins require 6-8 fasteners.

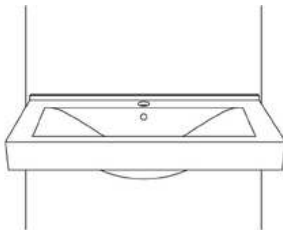

2. Predrill ramp

Bracket and screw holes are pre-drilled at the time of manufacture. On-site, holes can be drilled with a commercial drill and toughened drill bit to match the studs in the wall at the back of the basin. Drill at high speed.

Tapholes can be drilled with a 35mm round cutout drill bit at high speed. Mark the position to the center of the back panel.

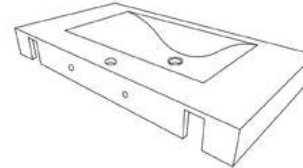

5. Connect and finishing

Connect all supply hoses to the faucet and connect the waste. Turn on the water supply to check for any leaking from the water supply lines or sink.

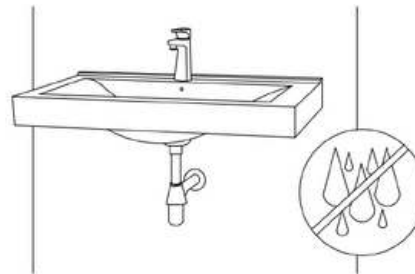

3. Mark and drill pilot holes on the wall

Determine the height you want the basin to sit ensuring the pre-drilled holes in the basin line up with the internal wall studs/nogs. Place basin against the wall and use a level to ensure it is straight. Mark the location of the bracket screw and fastener holes with a pencil then drill the pilot holes in the wall. The brackets can be secured to support the basin while you mark out the mounting holes.

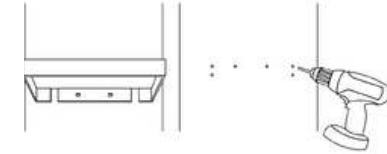

NOTE - Ramp basins with benchtop mounted faucets may require water pressure restrictors to reduce splash. This will be important with The Junior 100 Ramp Basins.