



PRO 2.85
DSP
DIGITAL AUDIO PROCESSOR

2(in)1
STANDARD
+ DYNAMIC PEAK



The installation of this product must be made by a qualified professional.

Index

- 01 • Warranty terms
 - Technical assistance
- 02 • Introduction
 - Safety requirements
 - Key recommendations
 - Safety
- 03 • DSP Overview
 - Screens & basic operation
- 04 • Output selection keys
 - Menu & parameters navigation
- 05 • Menu structure & description
 - Audio menu
 - Input/output routing
- 06 • Band equalizer
 - Input graphic equalizer
 - Crossover
- 07 • Delay
 - How to set the delay parameter value
- 08 • Phase
 - Limiter
 - RMS limiter (only in DYNAMIC PEAK mode)
- 09 • Limiter parameters
 - PEAK limiter (only in DYNAMIC PEAK mode)
- 10 • Output level
 - Output param. eq.
 - Mirror outputs
- 11 • Audio generator
 - Language
 - Save config.
- 12 • Load config.
 - Password / lock
 - EQ presets
 - Text message
- 13 • Select mode
 - Example of processor input and output wiring
- 14 • Technical Features

Warranty terms

TARAMPS, located on Julio Budisk RD, SN, KM 30 – Alfredo Marcondes, SP - Brazil, ZIP CODE 19180-000, warrants this product against any defects on terms of project, manufacturing, assembling, and/or with solidarity, due to project vices which cause it improper or inadequate to its original use within 12 months from the date of purchase. In case of defect during the warranty period, TARAMPS responsibility is limited to the repairing or replacement of the device of its own manufacture.

This warranty excludes:

- Damaged products by improper installation, water infiltration, violation by unauthorized individuals;
- Tamper or torn warranty seal;
- Cases in which the product is not used in adequate conditions;
- Defects caused by accessories, modifications or features attached to the product;
- The product with damage from falling, bumps or nature related problems (flooding, lightning, etc);
- Warranty card is not properly filled or torn;
- Costs involving uninstallation, reinstallation of equipment as well the shipment to the factory;
- Damage of any kind, due to problems in the product, as well as losses caused by discontinued use of the product.

Technical assistance

For international support, check on our website:

www.taramps.com.br/en/rede-de-assistencias-tecnicas or contact direct the factory support:

Phones: +55 18 3266-4050 / +55 18 99751-4273

E-mail: service@taramps.com.br

Introduction

Read this manual before installing the product. In case of questions contact our technical support:

+55 (18) 3266-4050 or www.taramps.com.br.



At the end of its lifespan, this product must not be disposed of in household waste. Look for an electronic equipment collection or recycling center for proper disposal.



Safety requirements

To ensure proper use, please read through this manual before using the PRO 2.8S. It is specially important that you know the **CAUTIONS** contained here.

- The installation of this product must be done by a qualified professional.
- Use the correct tools for installing this product.
- This product is for use with 12V batteries. Always check the voltage before installing.
- This product must be installed in a firm location and away from heat sources.
- Never install the product in places exposed to dust, humidity and water. Pay attention to install it far from fuel tank, fuel lines, heat sources and other parts of the vehicle.
- Be sure to install protection fuse or a circuit braker near to the battery. Follow the current rating as indicated here in this manual. The use of improper fuse or circuit breaker can result in overheat, smoke, damage to the product, injury or burns.
- Avoid running wires over or through sharp edges. Use rubber or plastic grommets to protect any wires routed through the car.
- Automotive sound systems may produce high sound pressure levels. Avoid continuous exposure to levels over 85dB to prevent permanent hearing loss.

Key recommendations

The wire gauge for power supply connections is 1,5mm² (15 AWG) for positive and negative wires, and 0,50mm² (20 AWG) for remote signal wire.

For protection against overload, install a fuse on positive wire, close to battery terminal (1A). See page 12.

- 1 - ⚡Power supply negative: Connect to negative pole of battery.
- 2 - Remote signal input: Connect to remote signal output from head unit.
- 3 - Remote ouput: For connection in amplifiers
- 4 - ⚡Powe supply positive: Connect to positive pole (12V) of battery.

⚠ Safety

As you read this manual, pay attention to the safety symbols.



This symbol with **“CAUTION”** is intended to alert the user to the presence of important instructions. Failure to heed the instructions will result in risk of injury to user or product damage.



Taramps reserves the right to modify the contents of this document at any time without prior notice and does not have the obligation to apply the changes in units which were previously produced.

DSP Overview

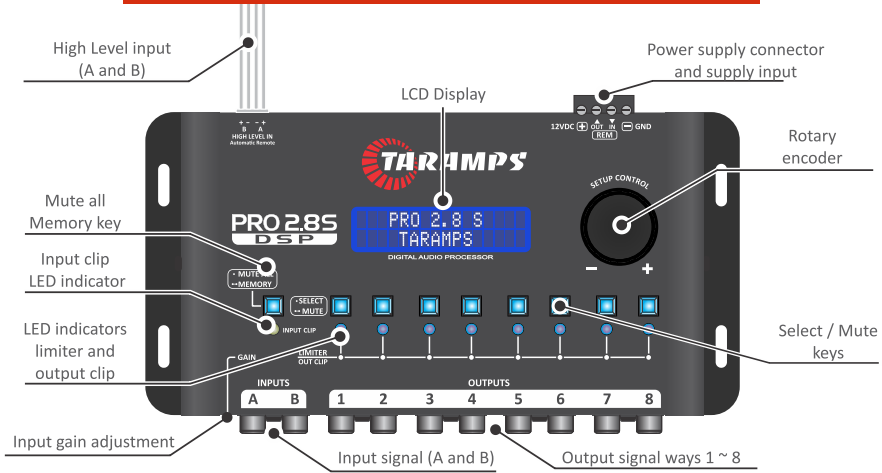

Input gain adjustment: With this adjustment in the MAXIMUM position, the DSP accepts signals of up to 2V RMS at the input. (Normal sensitivity). With the gain adjustment at MINIMUM, it is possible to apply signals from up to 9V RMS, without distorting the input. (Minimum sensitivity).

RCA input signal: Input for low level/high impedance signals (RCA).

WIRED input signal: Input for high level/low impedance signals (from the speaker output of multimedia centers or head unit).

It has the function of turn on through the input signal, therefore it does not need to use the REMOTE IN wire of the power connector when using this input.

Note: The system was designed for use in practically all head units and multimedia centers on the market. However, in some head units, the turn on function may not be obtained due to the type of audio output circuit. In this case, use turn on through the REMOTE wire normally.

Input clip LED indicator: Indicates that the signal is reaching the maximum limit of the processor input, which causes signal distortion. If this indicator lights up, reduce the processor input gain or adjust the level into source.

Limiter/clip LEDs indicators: Has dual functions: Indicate that the signal from the output has reached the maximum level (when the limiter is off) or that the limiter has activated (when the signal reaches the threshold set on the limiter).

Power connector: See page 12.

Screens & basic operation:



INITIAL SETUP: When turned on for the first time, the processor waits for the language to be set. Choose the desired language and confirm with a short press on the encoder.

Turning the encoder knob (clockwise or counterclockwise), adjusts the master volume (Input volume).



Output selection keys

Short press (click) on the key of each output(1 to 8) It performs an adjustment of the individual gain in each output.

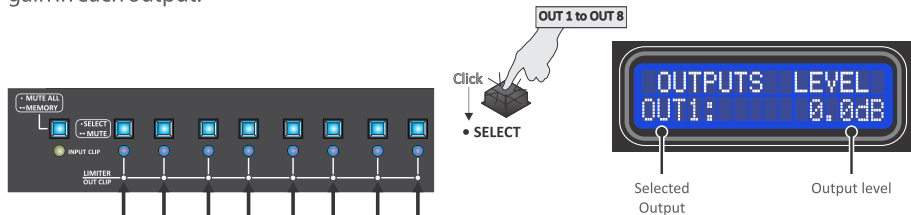

General mute: Short press the mute all / memory key to mute all outputs simultaneously. Press again to reactivate.

Individual mute: Long press the output key (1 to 8) until its light goes off. To exit individual mute, long press it again.

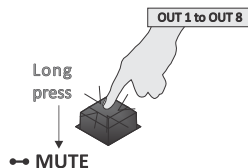

Short press on the center of the encoder, to access the MAIN MENU and its functions.
Long press on the center of the encoder returns to the previous menu on.

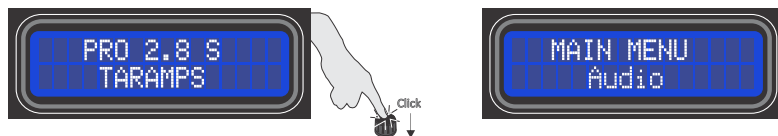

Menu & parameters navigation

Use the encoder, turning it left (decrease) or right (increase). Menu selection, options or parameter changes can be made by pressing the center of the encoder.

Note: On any of the audio adjustment screens, short pressing the output keys (1 to 8) allow you to check and adjust the parameters of each channel without leaving the desired menu.

Tip: To fine-tune a parameter or increase/decrease the number after the decimal point, turn the encoder slowly. For example, when adjusting the signal level (dB), the increase will be 0.1 dB when turning the encoder slowly, and 1 dB when turning it continuously and fast.



The PRO 2.8S is factory configured in STANDARD mode.

To access the DYNAMIC PEAK setting, go to the MAIN MENU on the last option "Mode Selection". See page 13.

Menu structure & Description

PT-BR	ENG	ESP
MENU PRINCIPAL :	MAIN MENU :	MENU PRINCIPAL :
1-Áudio	1-Audio	1-Audio
2-Gerador De Áudio	2-Audio Generator	2-Generador Audio
3-Idioma	3-Language	3-Idioma
4-Salva Config.	4-Save Config	4-Guardar Config
5-Carrega Config	5-Load Config	5-Cargar Config
6-Senha / Bloqueio	6-Password / Lock	6-Contraseña / Bloqueo
7-Presets EQ	7-EQ Presets	7-Preset EQ
8-Mensagem / Texto	8-Text / Message	8-Mensaje de Texto
9-Selecionar modo	9-Mode Selection	9-Modo seleccion

Long press the encoder to return to the main screen.

1- Audio menu: Adjusts and controls related to audio processing:

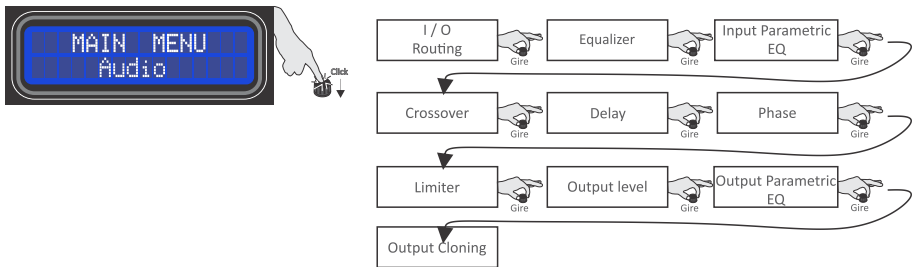

I/O Routing: Set the internal connections between outputs and inputs. Available options: A, B or A+B (sum of the two inputs).

E.g.: setting the OUT 1 output to A, its signal will only come from input A.



Use the OUTx keys to select the desired way

Turn the rotary encoder to select the input

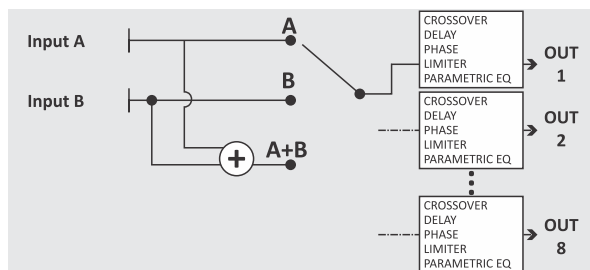

-Input graphic equalizer: It has 15 equalization bands, with attenuation/gain of up to 12 dB, at the central frequencies defined in the ISO standard (25 to 16 KHz, 2/3 octave).

It acts simultaneously on A and B inputs.

Only available in Standard mode

The Pro 2.8S has 12 predefined equalizations, selectable in MAIN MENU > EQ Presets.

Click on the center of the encoder to select the desired parameter

Turn the encoder to change the selected parameter

-Input parametric equalizer: Equalizer with adjustable parameters, acts simultaneously on inputs A and B.

G = Filter gain/attenuation (-12dB to +12dB)

F = Central filter actuation frequency, adjustable from 10Hz to 22KHz

Q = Filter width adjustment, from 0.4 (widest) to 10.0 (narrowest)

1 band in Standard mode
5 bands on DYNAMIC PEAK

Click on the center of the encoder to select the desired parameter

Turn the encoder to change the selected parameter

Gain or attenuation

Center frequency Width (Q)

+12dB
0dB
-12dB

10Hz 22KHz

Q
G+ Gain
G- Attenuation
F

-Crossover: Sets the high-pass (HPF) and low-pass (LPF) filters to be applied to the output paths. The cutoff frequencies are adjustable from 10Hz to 22KHz and are available in Butterworth, Linkwitz Riley filter types in different attenuations (-6, -12, -18, -24, -30, -36, -42 and -48dB octave).

High Pass Frequency selection (HPF)

Selected output

Cut off Frequency

Final Cutoff Freq. (LPF) Selection

Output way selection

Cut off Frequency

HPF

10Hz 22KHz

LPF

10Hz 22KHz

FILTER TYPE / ATTENUATION:

OFF:	Off
LR12	Linkwitz - Riley c/ -12dB/octave
LR18	Linkwitz - Riley c/ -18dB/octave
LR24	Linkwitz - Riley c/ -24dB/octave
LR30	Linkwitz - Riley c/ -30dB/octave
LR36	Linkwitz - Riley c/ -36dB/octave
LR42	Linkwitz - Riley c/ -42dB/octave
LR48	Linkwitz - Riley c/ -48dB/octave
BT6	Butterworth c/ -6dB/octave
BT12	Butterworth c/ -12dB/octave
BT18	Butterworth c/ -18dB/octave
BT24	Butterworth c/ -24dB/octave
BT30	Butterworth c/ -30dB/octave
BT36	Butterworth c/ -36dB/octave
BT42	Butterworth c/ -42dB/octave
BT48	Butterworth c/ -48dB/octave

Delay: Set the delay to be applied to audio signal, for systems alignment. The position of transducer's voice coil should be taken in account in order to set the optimal delay value.

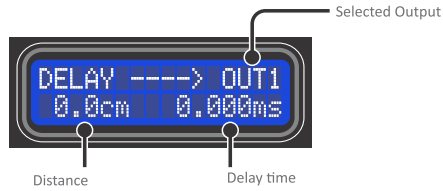

Rotate the rotary encoder to set the delay amount to be applied.

The voice coils of each transducers isn't aligned inside the acoustic box, so there is some delay that can degrade the perfect audio playing. The **Delay** feature apply different delay amount for each output way, in order to get the perfect audio alignment.

How to set the delay parameter value (centimeter):

- 1 Set the reference coil (*) farthest from the box panel (in our example, the reference was the center of the horn coil)
- 2 Measure the other channels and find the measure **A** . Set the closest measurement (in cm) for each channel.
- 3 Repeat the procedure for the other channels (the channel selection can be done through the keys of each channel).

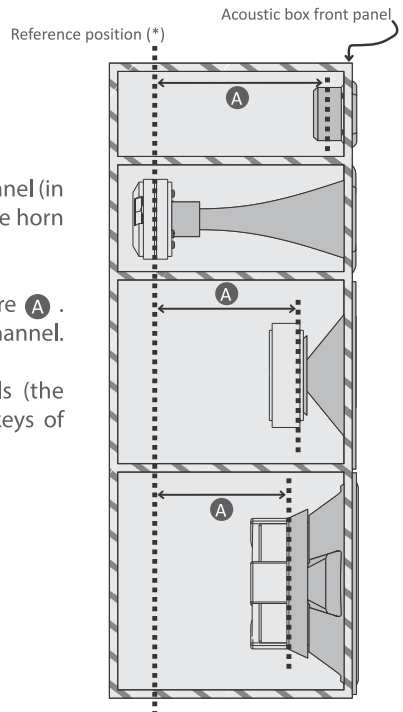

-Phase: Allows inverting the phase of the channel output signal, selecting option [180]. Select the channel using the OUT1 to OUT8 selection keys and select the desired phase by turning the encoder.

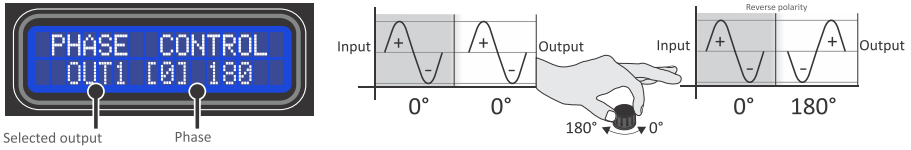

-Limiter: Sets the limiter, which acts as a limiter for the maximum signal level of the processor output, so as not to exceed the power limit defined for each channel.

Modes: **MAN** = Manual Attack and Release adjustment; **AUT**: Sets the Attack and Release parameters automatically, according to the channel's cutoff frequency (HPF).

Limiter parameters:

T = Threshold – Point at which the limiter begins to act (indicated by the RED LED on each channel turning on). To turn the limiter off, turn the encoder clockwise until [OFF] appears in the threshold value.

A = Attack – Time that the limiter waits before reducing the gain after the signal exceeds the threshold.

R = Release – Time that the limiter takes to return to the original gain after the signal drops below the threshold.

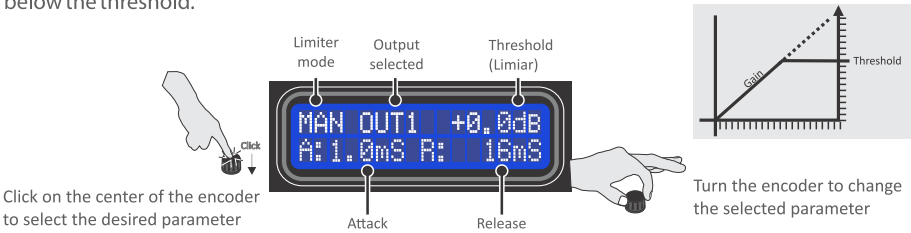

PEAK limiter (only in DYNAMIC PEAK mode)

-Limiter: Acts as a limiter for the maximum signal level of the processor output, so as not to exceed the power limit supported for each system transducer.

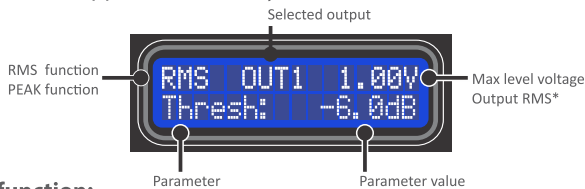

Limiter in RMS function:

Limiter that acts with reference to the RMS value of the audio signal, prevents overheating of the speakers due to excessive power.

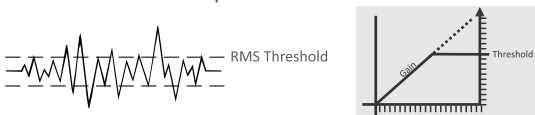

* According to Threshold selected. The accuracy of this measurement depends on the signal frequency as a function of the Attack time. At low frequencies, very fast attack times can affect measurement accuracy.

Limiter parameters:

Modes: **MANUAL** = Manual Attack, Hold and Release adjustment; **AUTO**: Sets the Attack, Hold and Release parameters automatically, according to the channel frequency cutoff (HPF).

Threshold – Point when the limiter begins to act (indicated by the RED LED on each lane turning on). To turn off the limiter, turn the encoder clockwise until [OFF] appears in the threshold value.

Attack, or Attack time – Time needed to limiter reduce the gain after the signal reaches the threshold.

Hold – Time that the limiter keeps the signal attenuated even after its level drops below the threshold.

Release, or Release time – Time needed to limiter return to the original gain after the signal drops below the threshold.

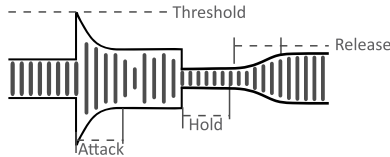

Limiter in peak function (DYNAMIC PEAK mode only)

Limiter that acts with reference to the PEAK value of the audio signal, prevents mechanical damage and overheating of the speakers due to excessive displacement.

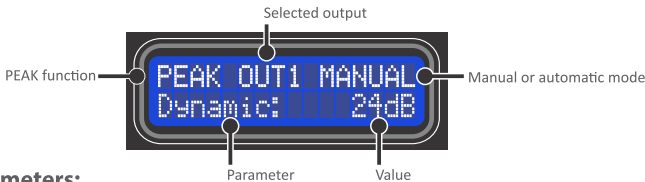

Limiter parameters:

Modes: **MANUAL** = Manual Release adjustment; **AUTO**: Sets the Release parameter automatically, according to the channel frequency cutoff (HPF).

Dynamic – Point when the limiter acts (indicated by the lighting of the RED LED on each channel) with reference to the peak value of the signal in relation to the threshold defined in the RMS limiter (Music Dynamics).

Hold – Time that the limiter keeps the signal attenuated even after its level drops below the threshold (Dynamic).

Release, or Release time – Time needed to for the limiter to return to the original gain after the signal drops below the threshold.

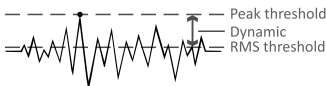

Examples:

Signal type	Dynamic
Sinusoidal	3 dB
Pink noise	6 ~ 12 dB
Heavy rock	10 ~ 12 dB
Rock / Pop	12 ~ 15 dB
Jazz	15 ~ 20 dB
Vocal	15 dB
Orchestra	10 ~ 24 dB
Bass	6 dB

- Output level: Sets the level of each output individually, allowing you to apply up to +15 dB of gain or -45 dB of attenuation, regardless of the overall volume. Select the channel using the selection keys (1 to 8) and adjust the level by rotating the encoder.

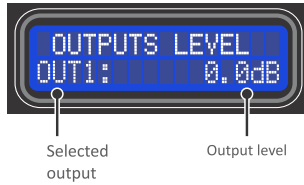

Note: This function can be accessed outside the menu by simply pressing the corresponding output key when on the main screen.

-Output parameter EQ: 1-band equalizer with adjustable parameters for:

G = Filter gain/attenuation (-12dB to +12dB)

F = Filter actuation center frequency, adjustable from 10Hz to 22KHz

Q = Filter width adjustment, from 0.4 (widest) to 10.0 (narrowest)

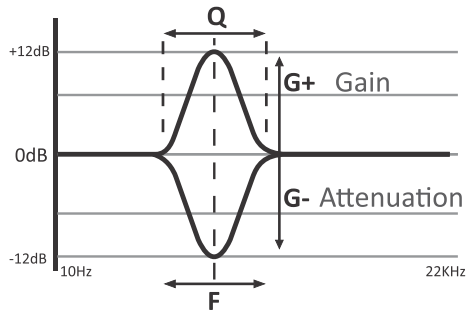
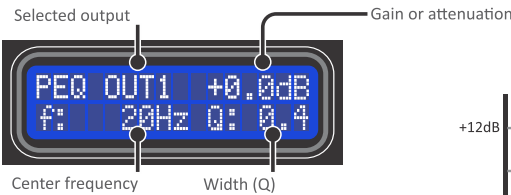

-Output Cloning: Allows you to use the parameters of another channel, creating a "clone" of an already configured output.

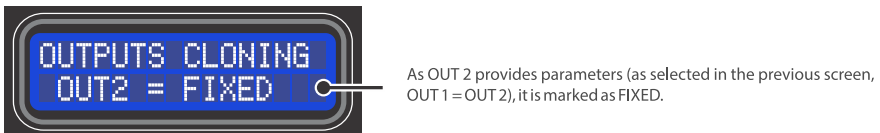
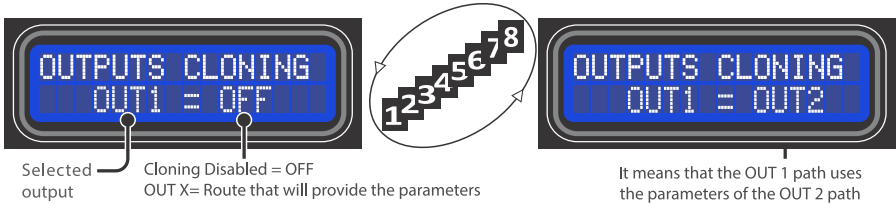



2-) Audio Generator: Sine wave generator, with frequency and variable amplitude. With 4 modes:

- **Fixed Frequency:** Sine generator with frequency (10Hz to 22KHz) and amplitude (-60dB to 0dB) adjustments. Note that when activating the generator, the signal is sent to all outputs and it is possible to adjust the other functions and parameters in real time, as the generator remains active and defined as a signal source when in the ON position, even when accessing another function.



*The voltage level shown is informative and may differ depending on the processing settings (Equalization, crossover, limiter, etc...).

- **Sweep (Slow / Medium / Fast):** It performs a signal sweep, with the initial and final frequency defined by the user, which remains in a continuous cycle (repeating) until the generator is turned OFF. There are 3 sweep speeds available.

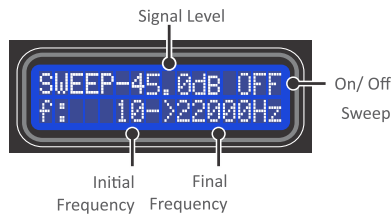

3-) Language: Choose the desired language (Portuguese, English or Spanish)



4-) Save config: Allows you to choose the memory location and assign a convenient name to these settings. Selecting which memory location, click on the encoder center to switch to the text. Rotate the encoder to select the desired letter, click on the center of the encoder to move to the next character. To erase, rotate the encoder until "<" + short press on the center of the encoder. To finish editing and save the memory name, place the cursor after the last character + long press on the center of the encoder and confirm "YES".

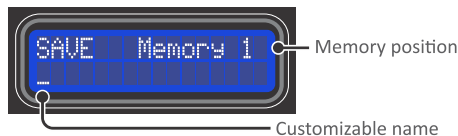



5-) Load config: Load a previously saved configuration or the factory default setting. Rotate the encoder to select the desired memory, click on the center of the encoder to select and then confirm. Important: when you select the FACTORY SETTINGS option, the previously saved settings will be lost.



6-) Password / lock: Allows you to lock the processor using a password (the default password is 1234) or change the password to a personalized one, with 4 digits. NOTE: When locking the processor, a padlock icon will appear in the upper right corner of the screen. A password will be required to access the settings. To reset the processor to factory settings without accessing the menu (e.g. due to lost/forgotten password), just turn on the processor while keeping the keys of outputs 1 and 2 and the center of the encoder pressed simultaneously. This will erase the contents of user settings memories and reset the product to initial setup.

7-) EQ Presets: The Pro 2.85 has 12 preset equalizer curves. Select the music style and press the encoder to apply the equalization curve:

- FLAT
- LOUDNESS
- BASS BOOST
- MID-BASS BOOST
- TREBLE BOOST
- POWERFUL
- ELECTRONIC
- ROCK STYLE
- HIP-HOP STYLE
- POP MUSIC
- VOCAL
- COMPETITION

8-) Text message: Defines a text of up to 15 alphanumeric characters to be displayed as screen saver animation. Enable the function by selecting ON and with a short press on the center of the encoder, and go to text editing (blinking cursor). Rotate the encoder to select the desired letter, click the center of the encoder to move to the next character. To erase, turn the encoder until "<" + short press on the center of the encoder. To finish editing and save the text, place the cursor after the last character + long press in the center of the encoder. After about 3 seconds of no activity on the main screen, the text will be displayed as an animation on the screen.

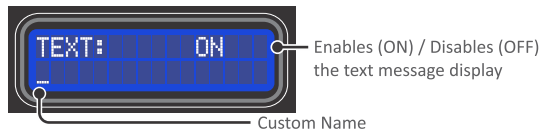

9-) Select mode: Selects the PRO 2.8S operating mode. STANDARD MODE or DYNAMIC PEAK.

The STANDARD mode presents functions in a way that facilitates adjustment for common audio systems.

The DYNAMIC PEAK system incorporates some advanced features, especially in the limiter.

RESOURCE	STANDARD	DYNAMIC PEAK
15-band graphic EQ	✓	✗
Input parametric EQ	1x	5x
RMS limiter	✓	✓
Peak limiter	✗	✓
Threshold limiter	-24dB a 0 dB	-48dB a 0 dB

Example of connecting processor inputs and outputs

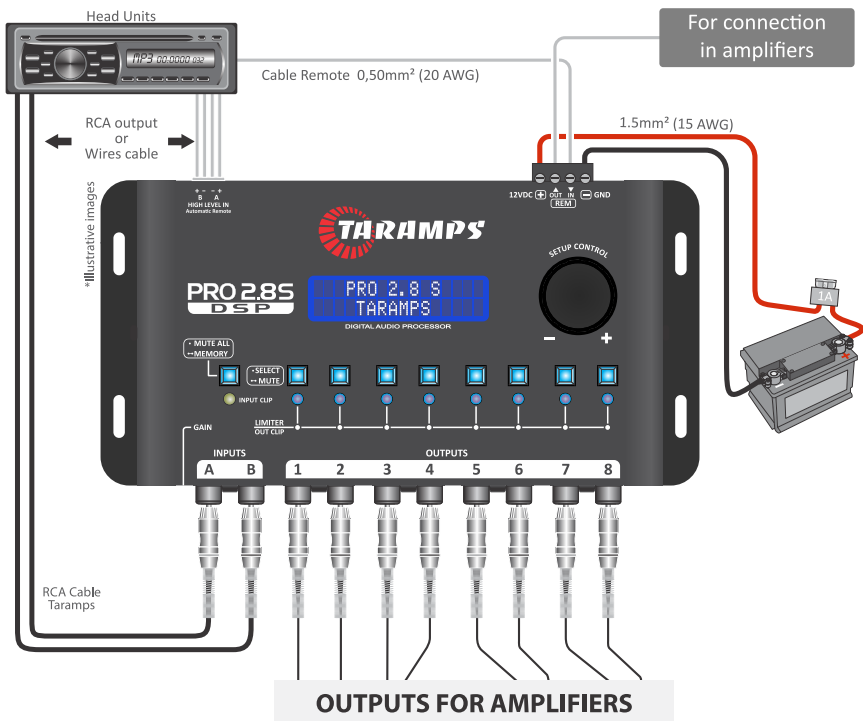

Check power polarity and recommended gauge. It is recommended to install a 1 A fuse on the positive supply cable.

Technical features

Processing

Resolution.....	24bits
Sampling rate.....	48KHz

Inputs and Outputs:

Number of input channels.....	2
Number of output channels.....	8
Input / output routing.....	A, B, A+B
Master gain adjustment.....	-80 a 0dB
Output gain adjustment.....	-45 a +15dB
Input impedance (RCA).....	10K ohms
Input impedance (high level).....	50 ohms
Output impedance.....	47 ohms
Maximum input level (RCA).....	9VRMS (Min. gain) / 2VRMS (Max. gain)
Maximum input level (High level).....	28Vpp (10V RMS)
Maximum output level.....	5,6Vpp (2V RMS)
Frequency response (-1dB).....	10Hz ~ 22KHz
Total harmonic distortion.....	0,01%
Signal / Noise Ratio.....	>90dB
Crosstalk (separation between channels).....	>80dB

Input graphic equalizer, 15 bands, 2/3 octave and 12 presets:

Frequencies.....	25,40,63,100,160,250,400,630,1K,1.6K,2.5K,4K,6.3K,10K,16KHz
Attenuation / Gain.....	-12dB to +12dB

STANDARD mode only

Input Parametric EQ:

Center Frequency.....	variable from 10Hz to 22KHz
Attenuation/Gain.....	-12dB to +12dB
Q Factor Adjustment.....	0.4 to 10

Crossover (HPF e LPF):

Cutoff frequency.....	variable from 10Hz to 22KHz
Linkwitz Riley Filters.....	-12,-18,-24,-30,-36,-42,-48dB/octave
Butterworth Filters.....	-6,-12,-18, -24, -30 -36, -42,-48dB/octave

Alignment (Delay):.....8,0mS (275cm)

Phase:.....0 / 180°

STANDARD mode only

Adjustable RMS limiter:

Threshold.....	-24 to 0dB
Attack.....	0.1mS to 100mS
Release.....	1mS to 1600mS

DYNAMIC PEAK mode only

Adjustable RMS Limiter:

Threshold.....	-48 to 0dB (8mV to 2VRMS)
Attack.....	0.1mS to 100mS
Hold.....	0 to 2000mS
Release.....	1mS to 2000mS

Output parametric EQ:

Central Frequency.....	variable from 10Hz to 22KHz
Attenuation / Gain.....	-12dB to +12dB
Q Factor Adjustment.....	0.4 to 10

Adjustable PEAK Limiter:

Adjustable Threshold/Dynamics.....	3 to 36dB
Hold.....	0 to 2000mS
Release.....	1mS to 2000mS

Individual MUTE function and general mute on outputs

Audio generator (Sine waveform)

Frequency range.....	Variable from 10Hz to 22KHz
Gain.....	-60 a 0dB
Modes.....	Fixed Frequency / 3 speed sweep

Languages:.....Portuguese, English and Spanish

Setting memory positions:Factory default + 3 assignable positions

Screensaver function:Text up to 15 characters

Access protection: 4 password digits (customizable)

Supply Voltage.....9 to 17VDC

Nominal consumption (12.6V).....0.30A

Dimensions (WxHxD).....198 x 37 x 113mm (7.80" x 1.46" x 4.45)

Weight.....0.45Kg (0.99lb)



+55 18 3266-4050

Manufactured by:
TARAMPS ELECTRONICS LTDA
TAX ID: 11.273.485/0001-03
Júlio Budisk RD, SN, KM 30
Alfredo Marcondes - SP
Made in Brazil
www.taramps.com.br