

OWNER'S MANUAL

Patio Furniture Swivel Chair

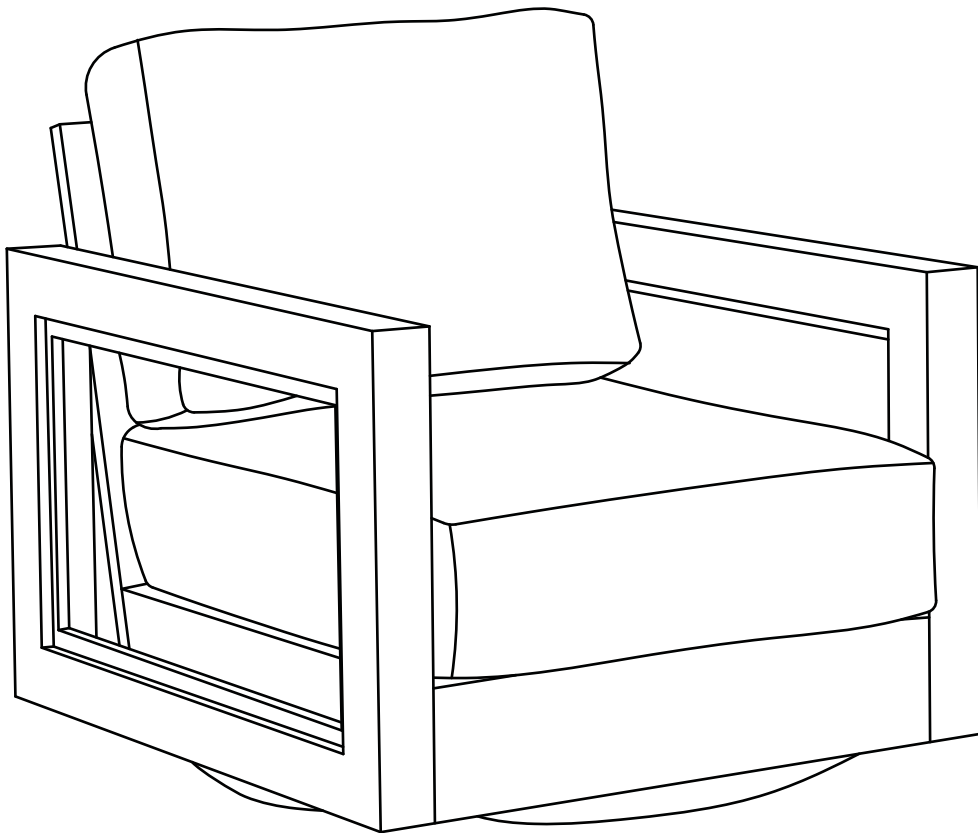

Scan the QR code to watch the installation video.



SAFETY PRECAUTIONS

WARNING



Please read and understand this entire manual before attempting to assemble or install this product.



Compare the parts in the box with those on the parts list provided - make sure that none are missing.



Some parts may have sharp edges. Please wear protective gloves when assembling or installing this product.



Choose and measure the location where you intend to place your gazebo - make sure your location is large enough. Choose a large assembly area where you can lay out and pre-assemble all parts for the gazebo.



Children and pets should be kept from your assembly area if possible. Supervise children and pets if they are in the assembly area.



Check all bolts for tightness before use, and periodically check and tighten bolts as necessary.

General Notes:

- ★ This item is heavy. Please handle it with care. Four or more people are required for this assembly.
 - ★ You will need these additional tools: a ladder and an adjustable wrench.
 - ★ Once a unit has been pre-assembled in each step, please set it aside until further instructions.
 - ★ The assembly process must be completed on a solid surface in strict accordance with the requirements of the instructions.
 - ★ You do not need to remove the gazebo in severe weather like rain and snow. However, please clear the roof in time to prevent damage to the frame and iron roof due to heavy snow or heavy rain.
 - ★ We care about your experience. Please feel free to contact us if you have any issues or comments. We will try to offer you efficient solutions ASAP.
-

WARRANTY COVERAGE REQUIREMENTS:

- ★ Pictures of the damaged parts.
 - ★ The order number of your product.
 - ★ Please gather all of this information BEFORE you contact us.
 - ★ Do not use this item in a way inconsistent with the manufacturer's instructions, as this could void the product warranty.
-

PRODUCT WARRANTY INSTRUCTION



Free Warranty Period:

The free warranty period starts from the product receipt date and lasts one year.



Coverage during the Free Warranty Period:

1. If any components of the purchased product are damaged due to non-human-induced reasons (natural wear and tear excluded), corresponding new parts will be replaced free of charge.
2. If the entire purchased product is damaged due to non-human-induced reasons (natural wear and tear excluded) and cannot be further used, corresponding parts or a brand-new product will be replaced free of charge.



Coverage after the Free Warranty Period:

After the warranty period expires, replacement components will be provided to customers at cost price for continued service.



Additional Services:

After purchasing the product, customers can consult our staff for any product-related inquiries.

ACCESSORIES DISPLAY

A

Back

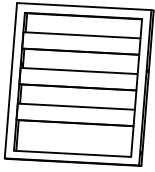

1PC

B

Seat

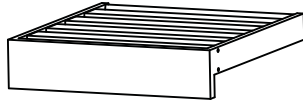

1PC

C

Left Arm



1PC

D

Right Arm



1PC

E

TR

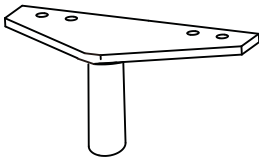

1PC

F

Holder

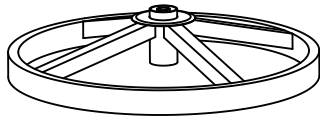

1PC

G

Sheet

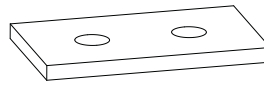

2PCS

H

M6 Washer

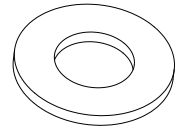

10PCS

I

M6 Wrench

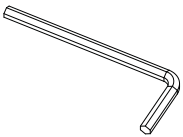

1PC

J

Spanner

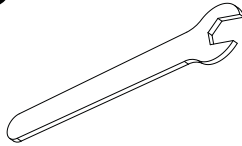

2PCS

K

Bolt M6x35

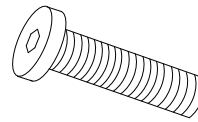

6PCS

L

Bolt M6x55

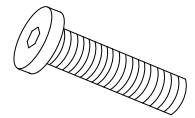

4PCS

M

M8 Washer

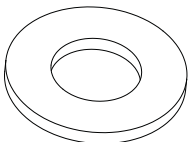

8PCS

N

Spring Washer

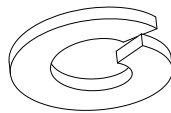

8PCS

O

Bolt M8x50

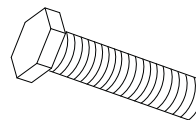

4PCS

P

Nut



4PCS

Q

Back Cushion

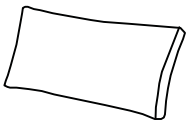

1PC

R

Seat Cushion

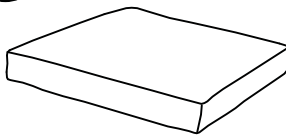

1PC

PRODUCT ASSEMBLY

STEP 1

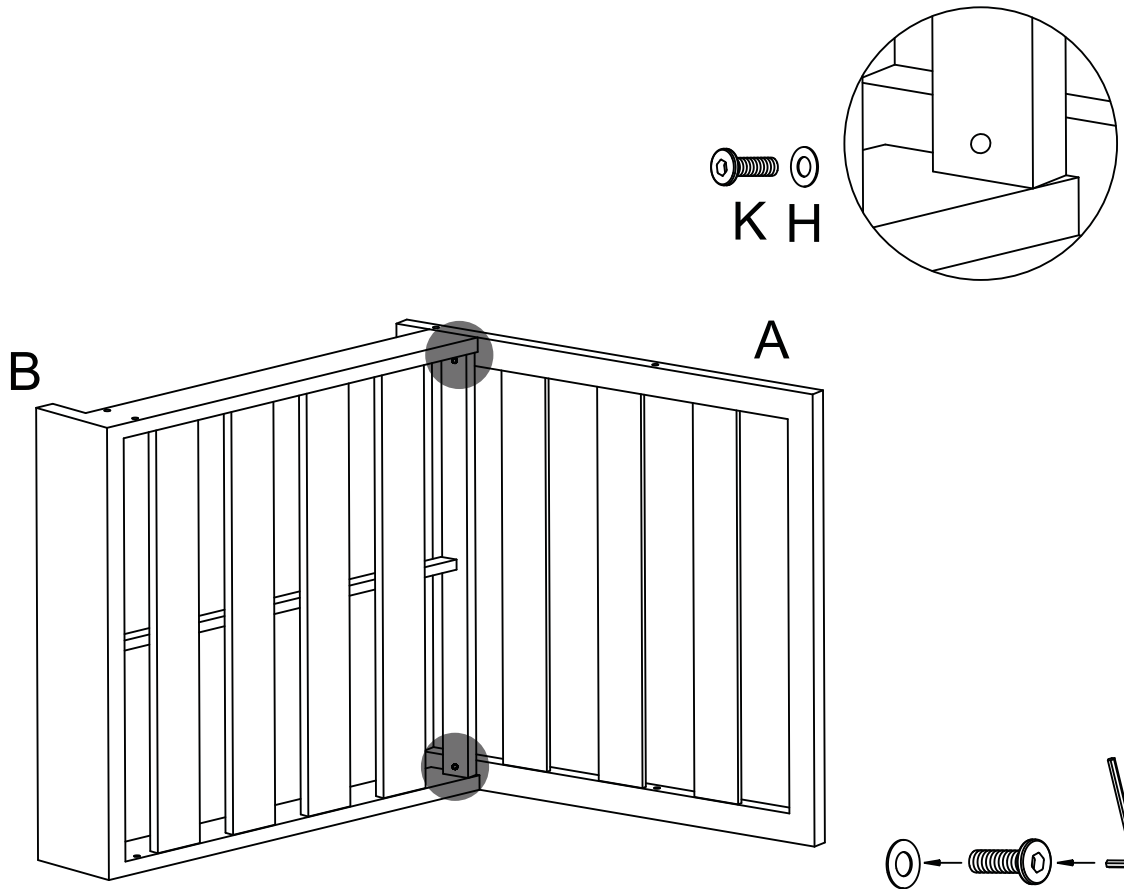
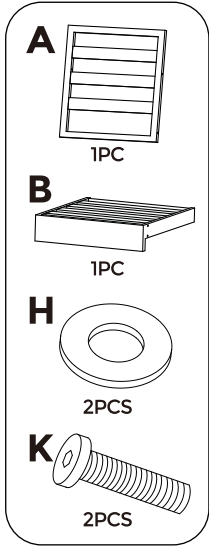

STEP 2

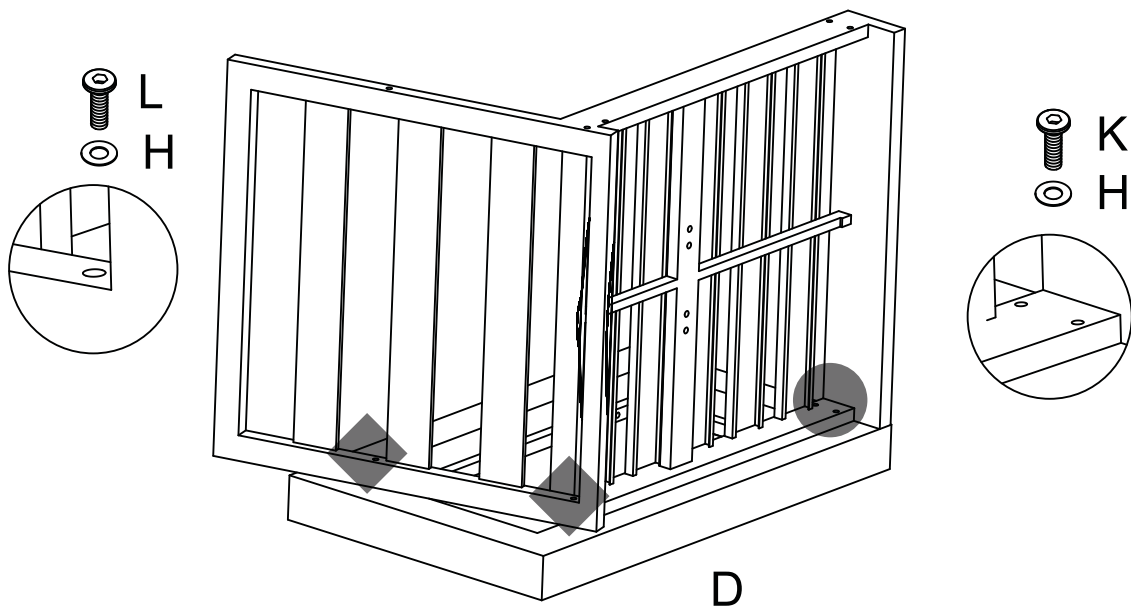
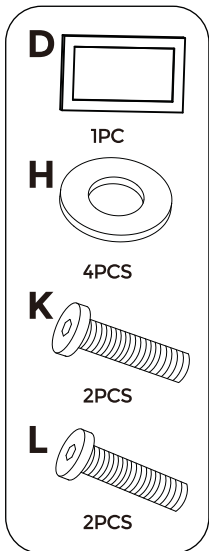

PRODUCT ASSEMBLY

STEP 3

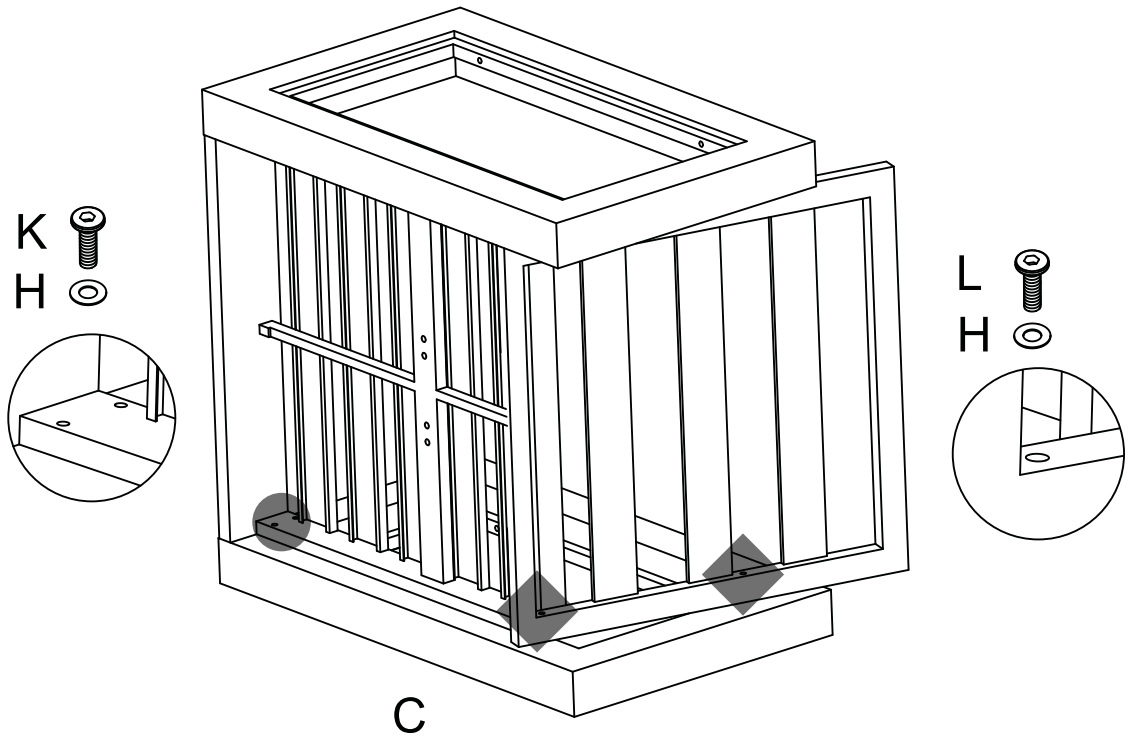
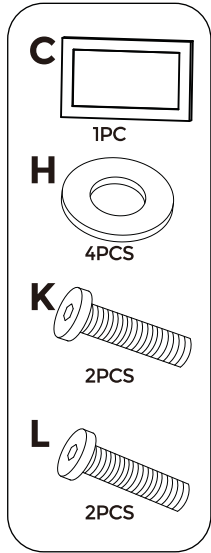

STEP 4

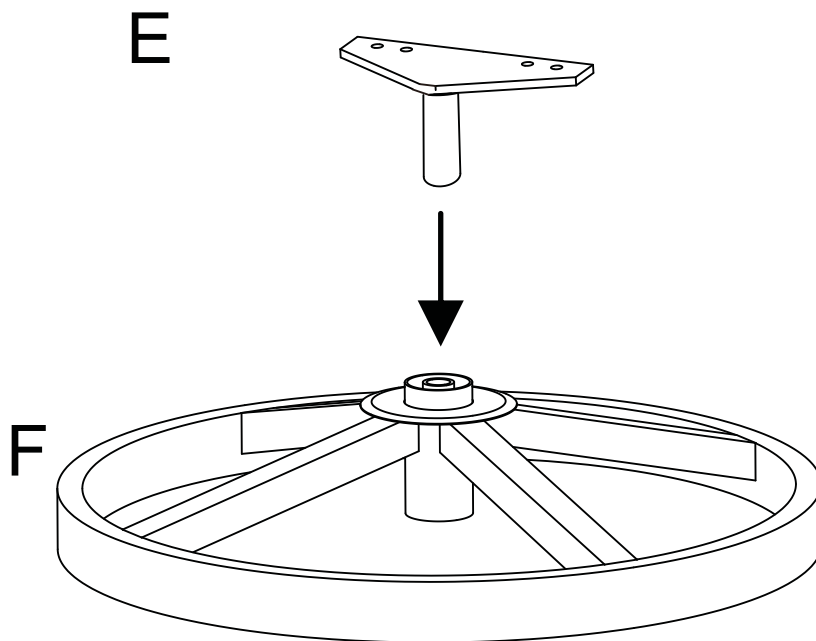
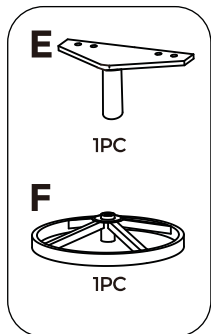

PRODUCT ASSEMBLY

STEP 5

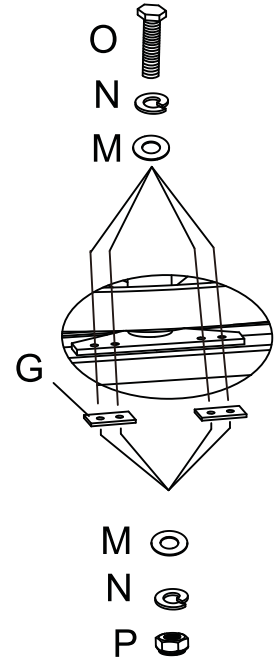
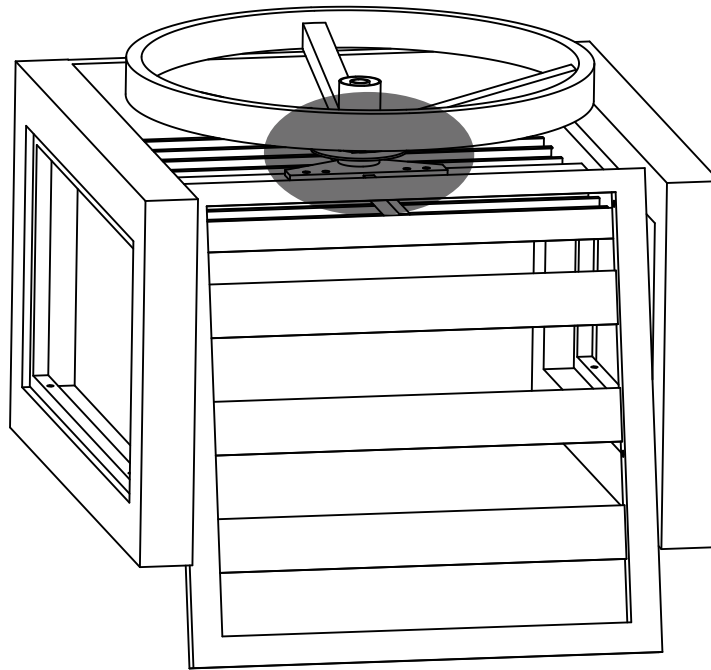
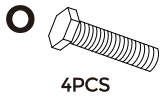
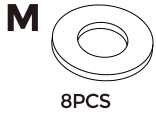
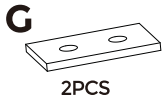

STEP 6

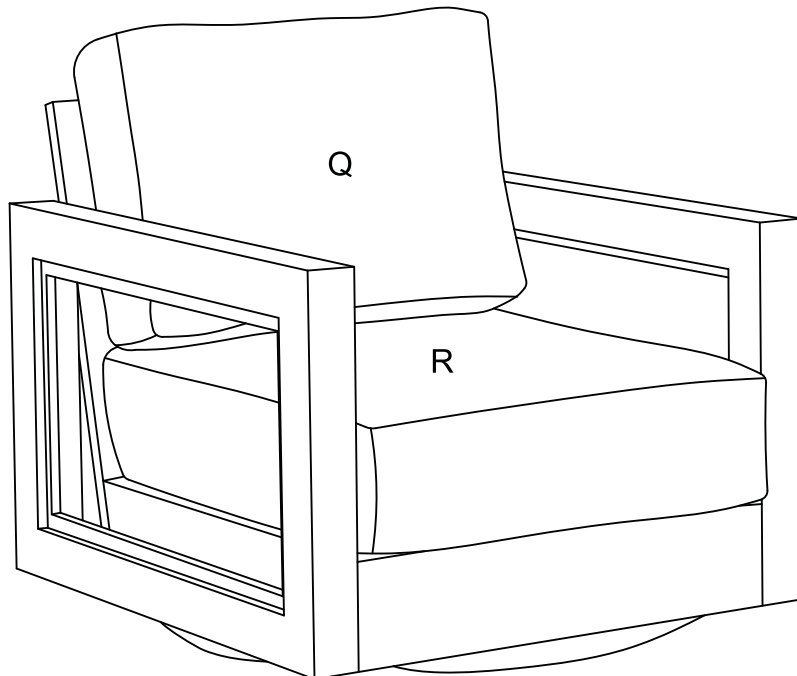
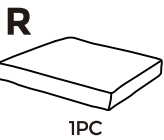
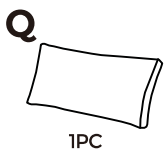

PRODUCT ASSEMBLY

COMPLETE

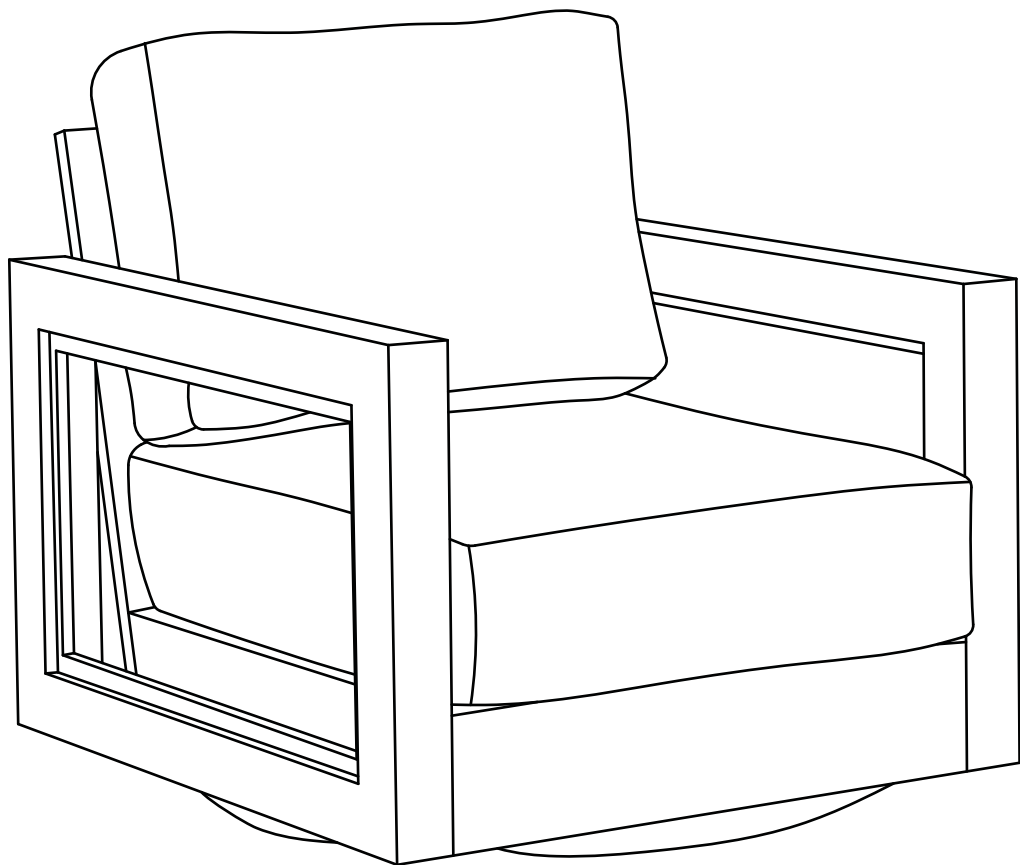

OWNER'S MANUAL

Patio Side Table

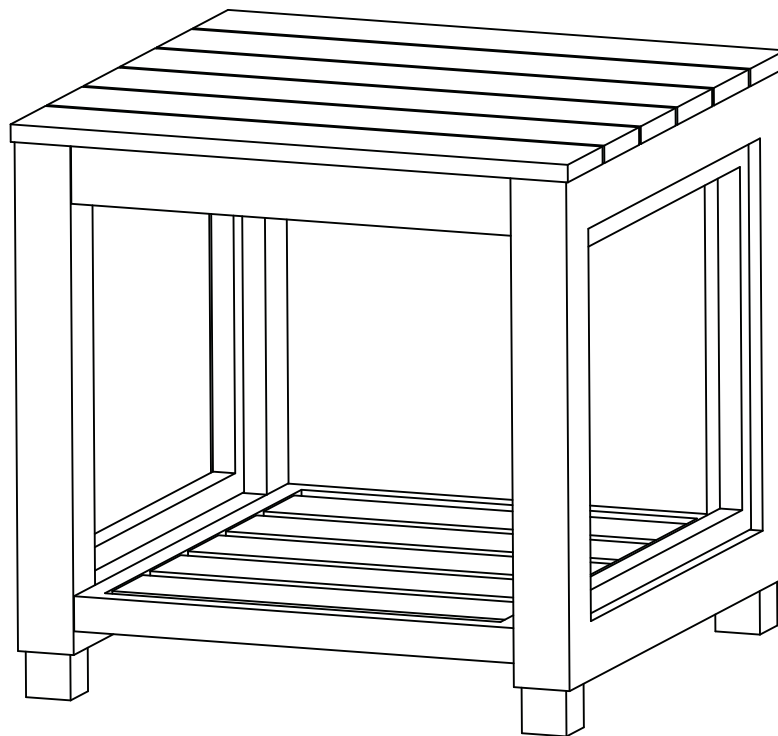

ACCESSORIES DISPLAY

A

Upper

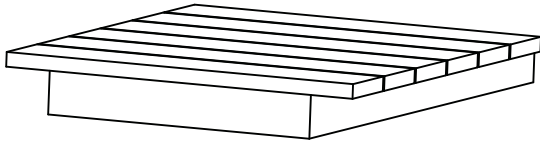

1PC

B

Leg

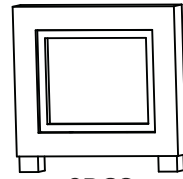

2PCS

C

Lower



1PC

D

Washer

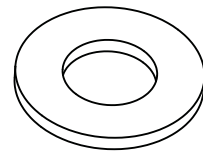

8PCS

E

Bolt M6 X 35

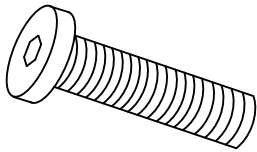

8PCS

F

Wrench

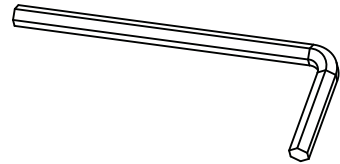

1PC

STEP 1

A



1PC

B



2PCS

D

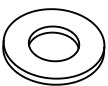

4PCS

E

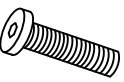

4PCS

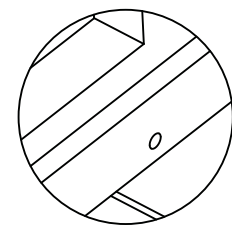
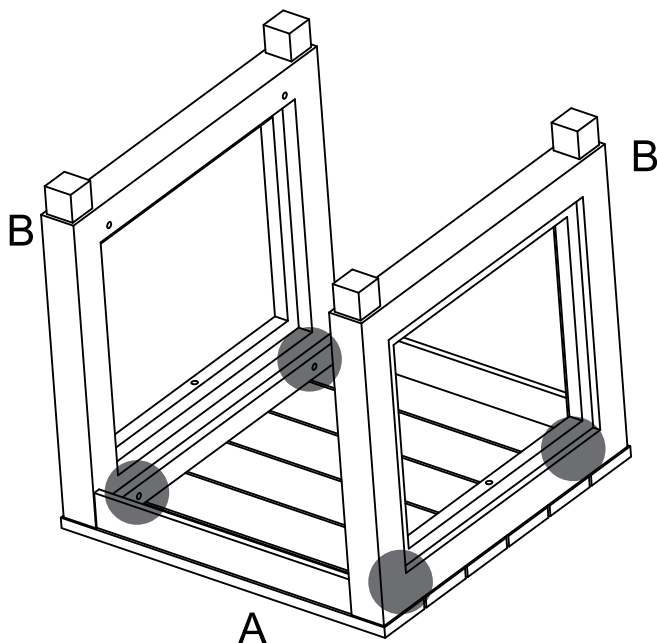

D E

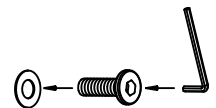

PRODUCT ASSEMBLY

STEP 2

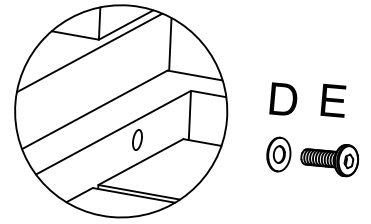
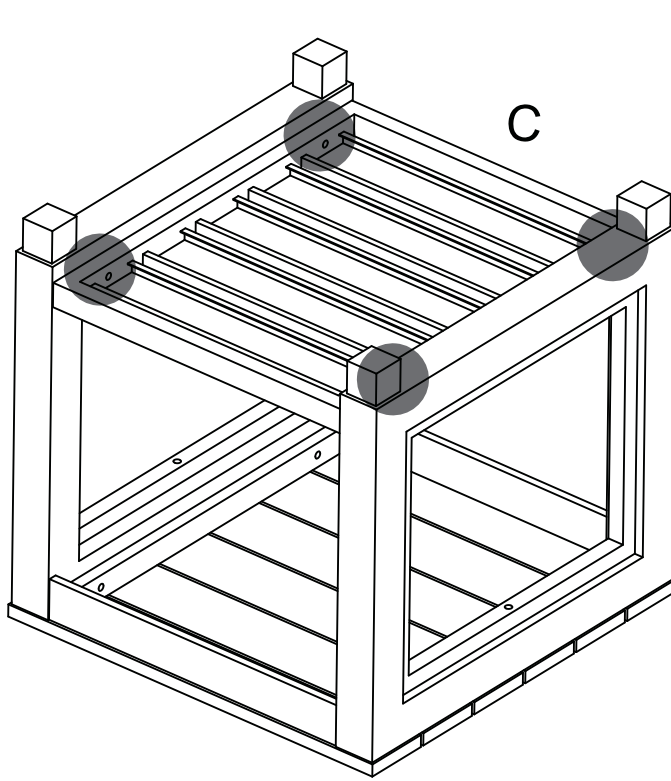
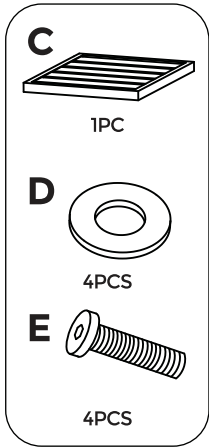

COMPLETE

