

TIMEGUARD®

2x 10W LED Wi-Fi PIR Twin Floodlight - Black

Model: LED200WFB



Installation & Operating Instructions



1. General Information

These instructions should be read carefully and retained for further reference and maintenance.

Note: Timeguard reserve the right to alter these instructions at any time. Up to date instructions will always be available for download at www.timeguard.com

2. Safety

- Before installation or maintenance, ensure the mains supply to the luminaire is switched off and the circuit supply fuses are removed or the circuit breaker turned off.
- It is recommended that a qualified electrician is consulted or used for the installation of this luminaire and install in accordance with the current IEE wiring and Building Regulations.
- Check that the total load on the circuit including when this luminaire is fitted does not exceed the rating of the circuit cable, fuse or circuit breaker.
- To clean use a clean dry cloth only. Do not use liquid cleaners.

3. Technical Specifications

- Mains Supply: 230V AC 50Hz
- This luminaire is of class II construction
- Energy Usage: 17 Kwh/1000h
- Beam Angle (Per Spotlight): 120°
- Lamp Adjustment Pan and Tilt: Left and Right 35°
, Downward 80°
- Lumen Output: 2000lm
- Colour Temperature: 3000K - 6500K
- Operating Temperature: -20°C to +50°C
- Back Box Mounting Hole Centres: 84mm
- IP Rating: IP55

- Motion Detection Range: Up to 10m at a 2.5m mounting height
- Detection Angle: 140°
- Full Light Time On Adjustment: 5 seconds to 60 minutes
- 2nd Stage Time On Adjustment: 1 minute to 8 hours
- Lux Adjustment: 10 to 1000 lux
- Standby Power Consumption: 0.5W
- PIR Warm Up Duration: 5-10 seconds (approx)
- Manual Override: Yes (App Based)
- Hi-Lo Dimming (2nd Stage Lighting): Yes (In App Configuration)
- CE / UKCA Compliant
- Construction: Polycarbonate
- Product Dimensions (H x W x D): 205mm x 195mm x 78mm
- With Corner Bracket (H x W x D): 205mm x 195mm x 95mm

2

4. Operating Modes (Tuya Smart App)

Manual Override: Turn the light ON / OFF as required.

Temperature Wheel: Sets the colour temperature of the luminaire.

Delay Setting: Delay either the startup or shutdown times of the luminaire.

Schedule: Setup timed ON/OFF parameters for the luminaire to switch on/off during a 7 day period.

PIR Options: Enable or Disable the PIR.

Motion Distance: Change the PIR's sensitivity settings.

Lux Adjustment: Change the PIR activation triggers based on the ambient light i.e. trigger light when dark, after evenings or after dusk.

Light Duration: ON time of the luminaire after triggered via the PIR.

Hi-Lo Dimming (2nd Stage Lighting): Set the brightness and duration of the luminaire once there is no movement detected.

5. Tuya Smart App Requirements

- Smartphone/Tablet with at least iOS 11.0 or Android 7.0.
Minimum requirements subject to Tuya Inc. and not Timeguard.
- WLAN-enabled router: 2.4GHz (Separate Band)

6. Selecting a location

- The PIR has a number of detection zones, at various vertical and horizontal angles as shown. See image A

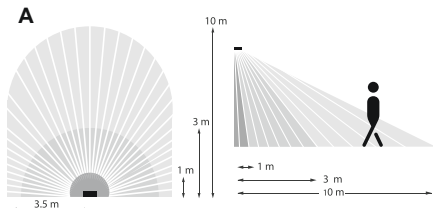

- The best all-round coverage is achieved with the floodlight mounted at the optimum height of 2.5 metres. See image B.

- Appropriate positioning of the PIR is required to ensure optimum performance.
- The PIR is more sensitive to movement across its field of vision than directly towards it. Therefore position the floodlight so that its PIR looks across the likely approach path where possible.
- Avoid positioning the floodlight where there are any sources of heat in the detection area of its PIR (extractor fans, tumble dryer or boiler exhausts etc.) including opposite any other light sources such as other security floodlights.
- Reflective surfaces (e.g. pools of water or white painted walls) and overhanging branches may cause false activation under extreme conditions.
- During extreme weather the PIR may exhibit unusual behaviour. This does not indicate a fault with the product. Once normal weather conditions return, the PIR will resume normal operation.

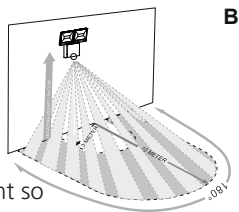

7a. Installation

This section covers installation without the use of the corner bracket. If the corner bracket is required for installation refer to section 7b Installation (Corner Bracket).

- Mark the position of the mounting holes on the wall using the back box as a template (See image 1).

Drill the holes ensuring not to infringe with any gas/water pipes or electrical cables that may be hidden below the surface.

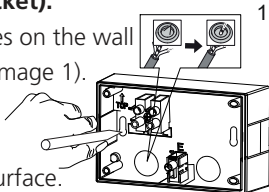

- Insert the rawl plugs into the holes.
- Pass the mains supply cables through the back box, using the appropriate knockouts and cable entry points to prepare for termination. Ensure the grommets are used to maintain the IP rating of the luminaire.

- Fix the back box to the wall using the two mounting screws, making sure it is the correct way up. Take care not to over-tighten the screws to prevent damage to the back box. (See Image 2).

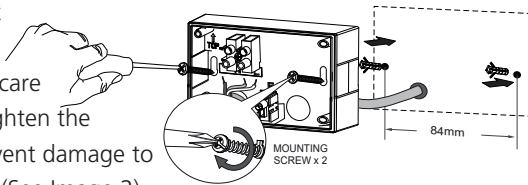

- The mains supply cable can now be terminated. Please refer to section 8 (Connection Diagram).

7b. Installation (Corner Bracket)

- Mark the position of the mounting holes on the wall using the corner bracket as a template (See image 3). Drill the holes ensuring not to infringe with any gas/water pipes or electrical cables that may be hidden below the surface.
- Insert the rawl plugs into the holes. If mounted to an external corner, as shown, there is a thin web of plastic that needs to be removed with cutters before installation. The corner bracket can also be used for internal corners (not shown).
- Fix the corner bracket to the wall using the two mounting screws, making sure it is the correct way up. Take care not to over-tighten the screws to prevent damage to the corner bracket.
- Pass the mains supply cable through the back box, using the appropriate knockouts and cable entry points to prepare for termination. Ensure the grommets are used to maintain the IP rating of the luminaire. (See Image 4)

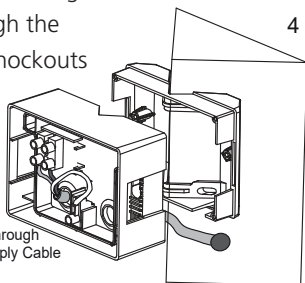
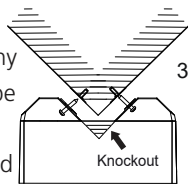

- The back box can then be secured to the corner bracket using the x4 Philips screws. (See image 5).
- The mains supply cable can now be terminated. Please refer to section 8 (Connection Diagram).

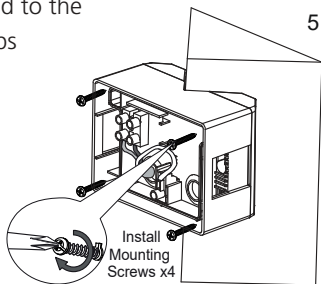

8. Connection Diagram

**230V AC 50Hz
MAINS SUPPLY**

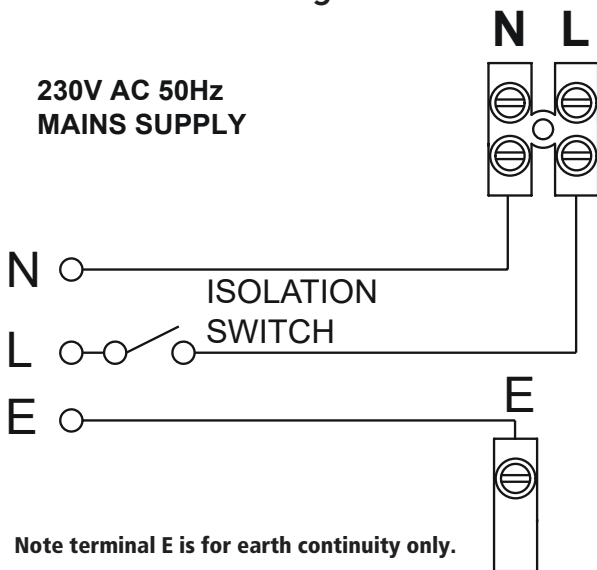

Note terminal E is for earth continuity only.

230V 50Hz Mains Supply

Live Supply (Brown or Red)

L

Neutral Supply (Blue or Black) to

N

Earth (Green/Yellow) to

E

- After the mains supply cable has been terminated. Re-connect the luminaire to the back box ensuring that the two lugs firmly latch on the left and right hand side, indicated by a 'click'.

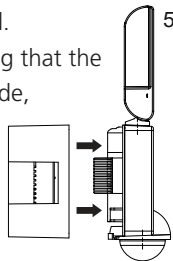

9. Downloading App & Registration

Note: the mobile or tablet device must be connected to a 2.4GHz band on the router. Pairing on the 5GHz band will result in pairing timing out or being unsuccessful. Refer to your ISP (Internet Service Provider) on separating the bands if required.

- Ensure your phone or tablet is connected to your local Wi-Fi network.
- Download the Tuya Smart App onto your phone or tablet by searching for **'Tuya Smart'** on Google Play or the App Store. You can also scan the QR code below applicable to your device.



- Install the App and open it to the registration screen. Click on the # **'Register'** button.
- Tap **'Agree'** to accept the privacy policy.
- Choose your region by selecting your **'Country Code'**. Enter your email address and phone number and click **'Get Verification Code'**.
- Enter the verification code sent to the email address or phone number that you provided. Once you have successfully entered the code, the app will automatically move you to the password screen.

- Assign a password (this must be between 6 to 20 characters including letters and digits) and click **'Done'**. The App home page will now appear.

10. Pairing Your Device(s)

Note: if you are using a VPN, make sure this is disabled before continuing, and ensure that the 2.4GHz Wi-Fi band is enabled for this device, separate from the 5GHz band.

- Once you are on the home page of the Tuya Smart App press the plus button **'⊕'** on the top right hand side of the app.
- Under the **'Add Manually'** menu, select the **'Lighting'** category on the left hand side of the app. Then select **'PIR Light (Wi-Fi+BLE)'** from the devices list.
- Turn the isolation switch off,on,off,on,off,on. The luminaire will begin breathing (dim up/down) indicating pairing mode is active.
- Select the **'Confirm the indicator is blinking or breathing'** option on the App, then press the **'Blink quickly'** button to begin the pairing process.
- Enter the Wi-Fi password for the network your mobile or tablet is currently connected to and then press the **'next'** button.
- Shortly into the pairing process, the luminaire will stop breathing and become stable. This indicates that the device has joined the network.
- Once the device has been added to your account you may assign it a name or allocate it to a room location setup in the app.

8

11. Smart Home Assistant

For Smart Home Assistant services such as Google Home or Amazon Alexa, follow the on-board instructions on the TuyaSmart App. This can be found under the 'Me' section on the home page of the App.

Note: The Smart Home Assistant services supported by the TuyaSmart App may change as it is a 3rd party App Service. Any services that may be removed are the responsibility of TuyaSmart developers and not Timeguard.

12. Controls Screen

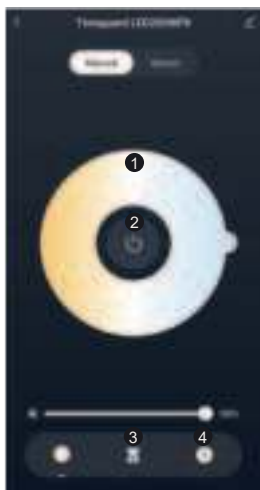

1

Temperature Wheel: Sets the colour temperature of the luminaire.

Left: Warm White Right: Cool White

2

Manual Override: Switch ON/OFF the luminaire as required. Note this is a permanent state.

3

Delay Setting: Delay either the startup or shutdown times of the luminaire. Note this function reverses the current state of the luminaire after a certain amount of time.

4

Schedule: Setup timed ON/OFF parameters for the luminaire to switch on/off during a 7 day period.

9

1

PIR Options: Enables or Disables the PIR.

2

Motion Distance: Change the PIR's sensitivity settings.

3

Lux Adjustment: Change the PIR activation triggers based on the ambient light i.e. trigger light when dark, after evenings or after dusk.

4

Linked Devices: Trigger other Wi-Fi lighting when the PIR is activated. (Device Grouping).

4

Event Records: Review when the luminaire has been triggered. (Log of events)





1

Full Light Duration: Set the timeout duration of the luminaire after being triggered via the PIR.

2

Hi-Lo Dimming (2nd Stage Lighting): Enable the light to stay on at a dimmed level once the PIR detects there is no movement in the detection area.

3

Hi-Lo Dimming (2nd Stage Brightness): Set the brightness of the luminaire once the full light duration period has ended.

4

Hi-Lo Dimming (2nd Stage Duration): Set the timeout duration of the dimmed light on the luminaire once the full light duration period has ended.

10

3 Year Guarantee

In the unlikely event of this product becoming faulty due to defective material or manufacture, within 3 years of the date of purchase, please return it to your supplier with proof of purchase and it will be replaced free of charge. For years 2 to 3 or with any difficulty in the first year, telephone our helpline.

Note: a proof of purchase is required in all cases.

For all eligible replacements (where agreed by Timeguard), the customer is responsible for all shipping/postage charges outside of the UK. All shipping costs are to be paid in advance before a replacement is sent.



If you experience problems, do not immediately return the unit to the store.

Email the Timeguard Customer Helpline:

HELPLINE

helpline@timeguard.com

or call the helpdesk on 020 8450 0515

Qualified Customer Support Coordinators will be online to assist in resolving your query.



A **theben** Group Company

For a product brochure please contact:

Timeguard Limited.

Victory Park 400 Edgware Road,
London NW2 6ND

Sales Office: 02084521112
or email csc@timeguard.com

www.timeguard.com

67.058.705 (Issue 1)