

# TOTAL

One-Stop Tools Station

TOTAL

## ROTARY HAMMER



# 1500W

# Security instructions



## Caution

Read all safety warnings and all instructions. Failure to follow the warnings and instructions may result in electric shock, fire, and/or serious injury.

*Note: Save all warnings and instructions for future reference.*

### 1) Work area safety

- a. Keep the work area clean and well lit to prevent accidents.
- b. Do not use power tools in explosive atmospheres, such as in the presence of flammable liquids, gases, or dust that can cause fires.
- c. Keep children and other unauthorized persons away while using a power tool. Distractions can cause you to lose control of the tool.

### 2) electrical safety

- a. Power tool plugs must match the outlet. Never modify the plug in any way. Using a suitable plug reduces the risk of electric shock.
- b. Avoid bodily contact with grounded surfaces such as pipes, radiators, ranges, and refrigerators. There is an increased risk of electric shock if your body is grounded.
- c. Do not expose power tools to rain or wet conditions. Water entering a power tool will increase the risk of electrical shock.
- d. Never use the cord to carry, pull or unplug the power tool. Keep the cable away from heat or oil.
- e. When using a power tool outdoors, use an extension cord suitable for outdoor use.
- f. If using the tool in a damp location is unavoidable, use a Residual Current Device (RCD) protected supply to reduce the risk of electric shock.

### 3) Personal security

- a. Always stay alert, watch what you are doing and use common sense when using the tool.
- b. Do not use a power tool if you are tired or under the influence of medication or other substances.
- c. Wear personal protective equipment. Always wear eye protection. Protective equipment such as a dust mask, non-slip safety shoes, hard hat, or hearing protection used in the proper conditions will reduce personal injury. Also don't wear loose clothing or jewelry.
- d. Prevent the tool from turning on unintentionally. Make sure the switch is in the off position before connecting to power source and moving.
- e. Remove any adjusting wrenches or wrenches before turning on the power tool. An adjustable wrench or wrench placed in a rotating part of the power tool can cause serious injury.
- f. If devices are used for dust extraction and collection, make sure they are properly connected. Properly use these devices and you will reduce dust-related hazards.

### 4) Use and care of power tools

- a. Do not force the tool. Use the correct power tool for each use.

- b. Do not use the power tool if its power switch does not work. Any power tool that cannot be controlled with the switch is dangerous and must be repaired.
- c. Disconnect the plug from the power source before making any adjustments, changing accessories, or storing the tool to avoid accidental starting of the tool.
- d. Use the power tool, accessories and bits etc. in accordance with these instructions, taking into account the working conditions and the work to be carried out. Using the power tool for operations other than those intended could result in a hazardous situation.
- e. Store power tools out of the reach of children and do not allow people unfamiliar with the tool to use it.
- f. Keep power tools. Check for misalignment or binding of moving parts, breakage of parts, and any other conditions that may affect the operation of power tools. If it is damaged, have the power tool repaired before using it. Many accidents are caused by poorly maintained power tools.
- g. Keep cutting tools sharp and clean. Properly maintained cutting tools with sharp cutting edges are less likely to bind and are easier to control.

#### 5) Service

- a. Have your power tool serviced by a qualified person and use replacement parts recommended by the manufacturer. This will ensure that the safety of the power tool is maintained.

## Safety rules for correct use



Double insulation for additional protection



Please read the instruction manual before use.



CE conformity.



Wear safety glasses, hearing protection and a dust mask.



Waste electrical products must not be disposed of with household waste. Please recycle at the appropriate facilities. Check with your local authority or retailer for recycling advice.



Security alert. Use only accessories supported by the manufacturer.

## Additional security warnings

- Wear ear protectors. Exposure to noise can cause hearing loss.
- Use auxiliary handles, if supplied with the tool. Loss of control can cause personal injury.
- Hold power tool by insulated gripping surfaces when performing an operation where the cutting accessory may contact hidden wiring or its own cord.
- The cutting accessory coming into contact with a live cable could cause an electric shock to the operator.
- Always route the cable to the rear, away from the machine.
- Do not carry the machine by the cable.
- When working with the machine, always hold it firmly with both hands and stand firm.
- During breaks in work or when the tool is not in use (for example, changing work tools, repairs, cleaning, adjustment), disconnect the tool from the mains.
- Unqualified people cannot use this tool.
- Keep tool accessories out of the reach of children.
- Use only original accessories recommended by the manufacturer.

## Other risks

Even when the power tool is used as prescribed, it is not possible to eliminate all residual risk factors:

- a. Health defects resulting from vibration emission if the power tool is used for a longer period of time or if it is not managed and maintained properly.
- b. Injuries and property damage due to broken fixtures breaking suddenly.



### Caution

This power tool produces an electromagnetic field during operation. This field can, in some circumstances, interfere with active or passive medical implants.

To reduce the risk of serious injury, we recommend that persons with medical implants consult their physician before using this power tool.



If the cable is damaged or cut during work, do not touch the cable, immediately unplug the tool. Never use the machine with a damaged cable.

The machine must not be damp and must not be used in a humid environment.



### Attention

Safe operation of this machine is only possible when the operating or safety information is fully read and the instructions contained therein are strictly followed.



## Technical data

Technical sheet of the hammer drill	
<b>Power</b>	1500W
<b>Voltage</b>	220-240V~50/60Hz
<b>No load speed</b>	850/min
<b>Impact rate</b>	4400/min
<b>Energy</b>	5.5J
<b>Concrete drilling capacity</b>	32mm
<b>Steel drilling capacity</b>	13mm
<b>Wood drilling capacity</b>	42mm

## Product description

1. Spare chuck
2. Drill chuck
3. Dust cap
4. Lock sleeve
5. Auxiliary handle
6. Unlock button
7. Operating mode selection switch 1
8. Operating mode selection switch 2
9. ON/OFF switch

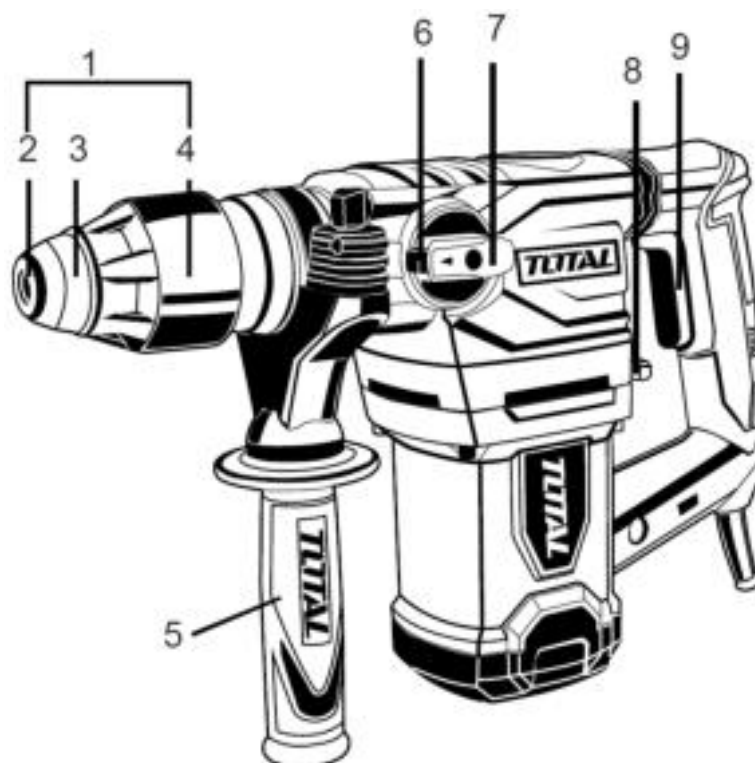

*Note: The machine is designed for impact drilling in concrete, brick and stone. It is also suitable for non-impact drilling in wood, metal, ceramics and plastic.*

*Note 2: Not all accessories illustrated or described may not be included in the standard delivery.*

# Set up

## Before using

Watch out for hidden power lines or gas and water pipes. Check the work area with devices such as a metal detector.

Always use the correct supply voltage. The power supply voltage must match the value indicated on the nameplate of the machine.

## Change of bits

Take care that the dust cap is not damaged when changing bits.

## Insert bits

- Clean and lightly the tool before inserting them.
- Insert the dust free bit into the chuck by turning until it clicks into place.
- The bit locks itself. He check the lock by pulling on it.

## Pull drill bits

Pull the locking sleeve back and hold it while removing the bit. Only use bits that fit the screw heads.

## Set up

- Power on: press the ON/OFF switch
- Power off: release the ON/OFF switch

## Work instructions

### Drilling overload stop

If the bit jams or binds, the rotation of the bit is interrupted. Due to the forces that occur, you should always hold the machine with both hands and take a safe stance. The machine must be used only with an auxiliary handle.

### Auxiliary handle

You can obtain a safe position when working with the tool rotated by holding the auxiliary handle. Loosen and turn the handle attachment counterclockwise.

To tighten the auxiliary handle:

- Loosen the wing screw on the auxiliary handle
- Set the drilling depth at the depth stop.
- Retighten the thumb screw.

# Operating modes



## Hammer drill mode

Turn the mode dial to  and turn the switch to 





*Note: When changing operating modes, please turn ON/OFF switch slightly.*

## Chisel mode

Turn the mode selector switch to  and then turn the switch to the direction 



## Drill mode

Turn the mode selector switch to  and then turn the switch to the direction 



# Maintenance

## Sharpening of chiseling tools

With sharp insert tools, good working performance and long service life are achieved.

Therefore, sharpen the chisel regularly. Sharpen the tool on a grinding wheel (eg alumina oxide) with a constant supply of water.

## For safe operation

- Always keep the machine and the ventilation slots clean.
- Clean the tool holder daily.

## Replacing the dust cap

Damaged dust caps should be replaced as dust seeping into the chuck can cause tool errors.

- Pull back and hold the locking sleeve.
- Remove the dust cap with a suitable tool.
- With the locking sleeve removed, pull on the new cap until it is seated firmly on the collet and the locking sleeve can slide forward again.

Should the machine fail despite the care taken in manufacturing and testing, contact your official TOTAL brand dealer.

## Environment



- Do not dispose of electrical appliances as unsorted municipal waste, use separate collection facilities.
- Contact your local authority for information on available collection systems.
- If electrical appliances are disposed of in landfills, hazardous substances can seep into the groundwater and enter the food chain, harming your health and well-being.
- Recycle raw materials instead of disposing of them as waste.
- The machine, accessories and packaging must be sorted for environmentally friendly recycling.
- Plastic components are labeled for categorized recycling.

## Exploded view

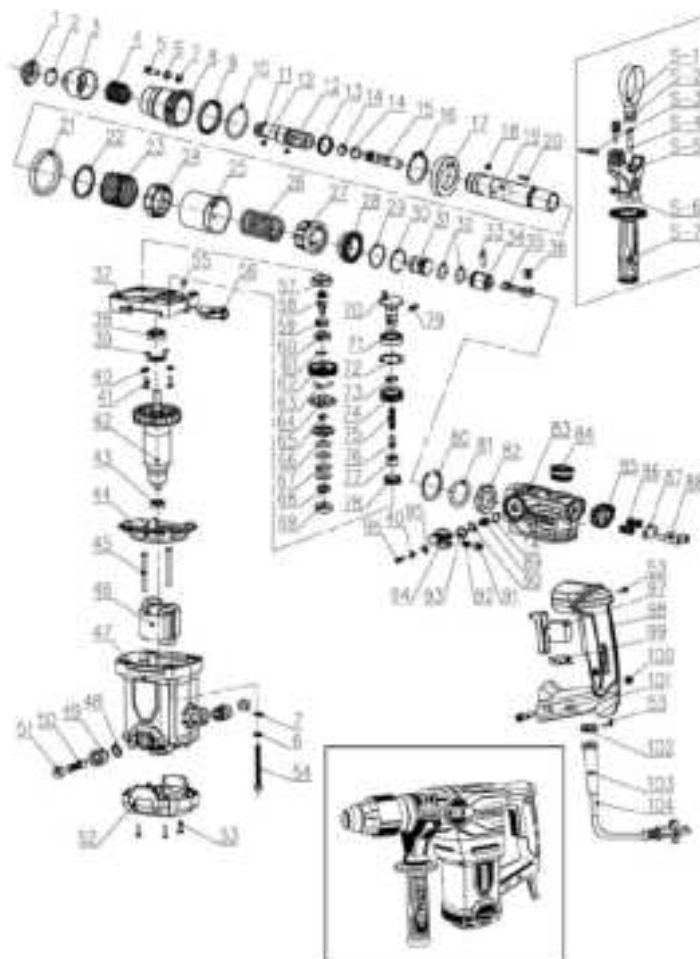

# TOTAL

One-Stop Tools Station

TOTAL

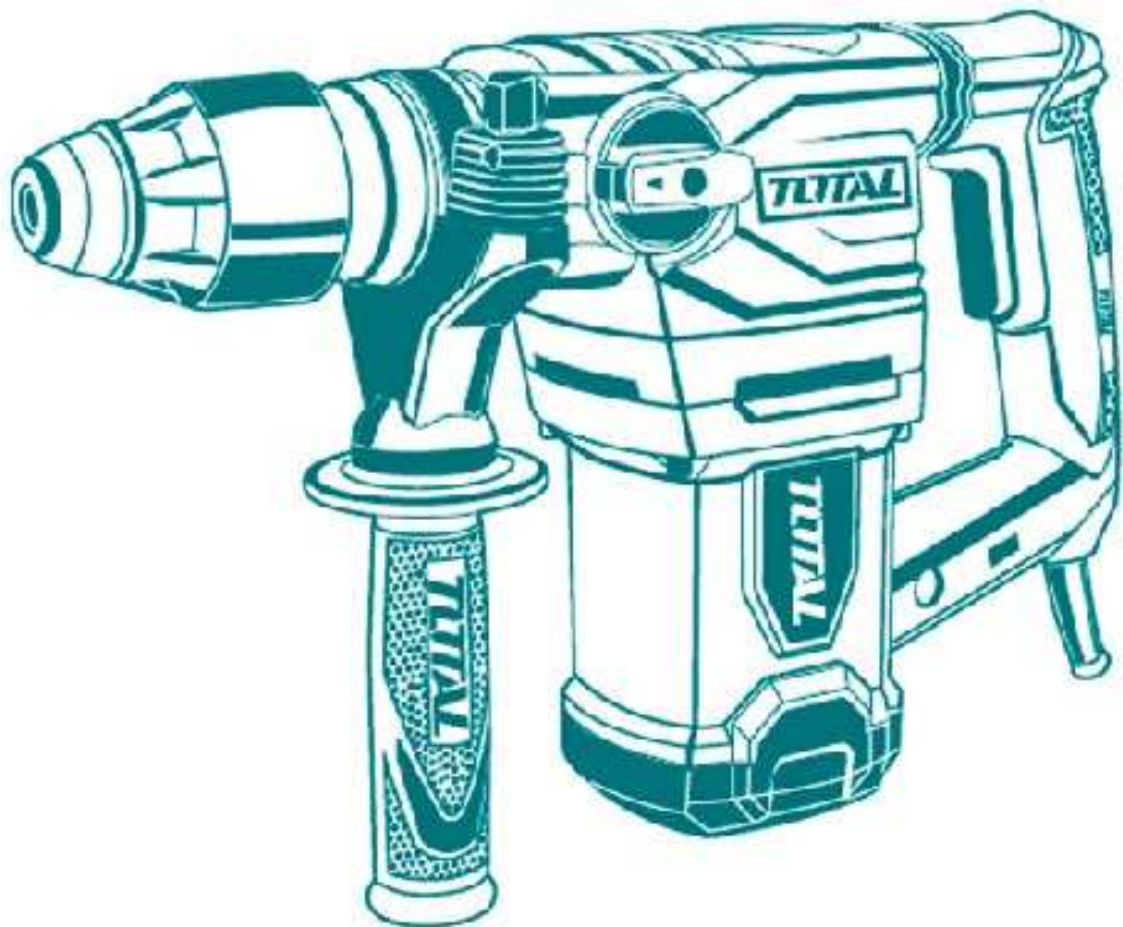

**ROTARY HAMMER**

**1500W**