



# TOWELRADS



## “*SMART Thermostatic*” Electronic control for towel radiators

**SMART Thermostatic** is an electronic thermostat for the automatic control of electric towel radiators. Using internal sensor, it is capable of keeping the temperature of the towel radiator to a desired value. Ten different electric resistances are available in a range between 100W and 1000W.

Operative modes: Comfort, Stand-by/Antifreeze, Boost 2h, P1, P2.

• **“Comfort” mode:** The thermostat keeps the towel radiators temperature at the level set by the user.

• **“Boost 2h” mode:** the heating element is activated for a period of 2 hours independently of the configured temperature. The temperature is automatically controlled so as not to exceed 65°C. At the end of the 2 hour period, the device returns to “Comfort” mode.

• **“P1” and “P2” mode:** The control system enters “Boost” mode for 2 hours; after that it returns into “Comfort” mode for 22 or 10 hours (configurable by the user P1 or P2) and then it enters again into “Boost” mode for 2 hours, repeating the same procedure endlessly.

• **“Standby/Antifreeze” mode:** if the temperature drops below 10°C the device will automatically activate the control system in order the internal liquid freezing



Available colors: - White  
- Chrome

**SMART Thermostatic** is a certified product: 



## “SMART Thermostatic” Electronic control for towel radiators

### TECHNICAL CHARACTERISTICS

Product	Electronic control for electric towel radiators
Applications	Towel radiators
Insulation class	Class I, Class 2
IP Level	IP44
Temperature setting	Digital
Selectable temperature range	40°C + 65°C 10°C Antifreeze
Operational temperature	-10°C + 40°C
Maximal power	See table or figure below
Supply Voltage	230VAC 50Hz
Dimensions	See table or figure below
Warranty	2 years

Approval mark	CE
Case	ABS-VO
Environmental directive	WEEE, RoHS
Operative modes	Comfort, Boost 2h, P1, P2, Stand-by/Antifreeze, Key-lock.
Thermostat status indicators	Boost/Timer led (red/green/amber). Comfort Bar with 6 LEDs: 1 blue, 1 green, 2 yellows, 2 reds.
Connection to mains	3 Cables (neutral, live, earth); Italian plug L.120cm; 2 Cables (neutral, live).Swiss plug L.120cm; spina Uk L.120cm; Schuko plug.
Available colors	White (RAL9016); Chrome
Maximal temperature of the thermal	152°C

Power	(W)	100	200	250	300	400	500	600	700	750	800	900	1000
Watt density	(W/Cm <sup>2</sup> )	1.1	2.3	4	3.2	3.4	4	3.6	3.6	3.6	3.6	3.7	3.7
L (heating element)	(mm)	350	350	370	370	430	450	560	630	700	700	760	830

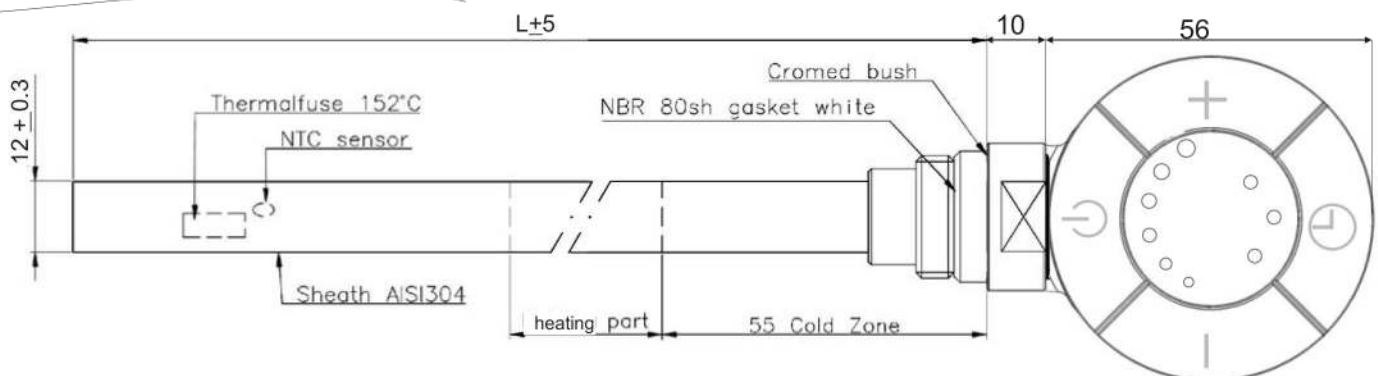

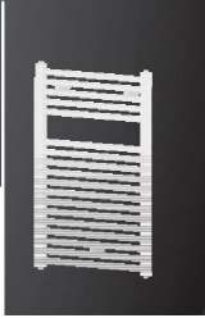

## **“SMART Thermostatic”** Electronic control for towel radiators

### **WARNING**

### **RISK OF ELECTRIC SHOCK!**

**Disconnect power supply before proceeding with installation.**

Please read carefully before using the device.

- Must be installed by a qualified electrician.
- The present device has been designed for exclusive use on a towel radiator.
- The thermostat in combination with a heating element is designed for heating the liquid contained inside a towel radiator. Any other use is forbidden.
- Before using, carefully ensure that the line voltage is the same as that specified for the thermostat (see technical specifications).
- Only use heating elements compatible with the type of used towel radiator
- Disconnect power supply before cleaning or before performing maintenance of the product.
- In case of damage to the supply cable, turn off the device and do not touch. The damaged power supply cables can be replaced by the manufacturer or by an authorized service center. Failure to either adheres to the above rules could lead to compromised system safety and invalidate the warranty.
- Store the heating element exclusively in the protecting packaging.
- Replacement of the heating element can be done exclusively by the product manufacturer.



## “SMART Thermostatic” Electronic control for towel radiators

### Installation Guide

**Must be installed by a qualified electrician.**

- Disconnect the device from power supply before proceeding with installation or maintenance.
- Protect the device with a 30mA RCD circuit breaker and an isolating switch to disconnect from

- 1) Insert the heating element in the threaded opening located on the bottom part of the radiator.
- 2) Securely fasten the electric resistance to the body of the towel radiator with a 22mm wrench.
- 3) The special sheath ensures a secure mounting and eventually allows a slight supplemental torsion to perfectly align the thermostat with the radiator.
- 4) Tilt the radiator as in fig. 3, making sure that the opening on top of the radiator is located on the highest side. **WARNING.** Do not lean the radiator on the electronic control!
- 5) Fill the radiator with the specific liquid.
- 6) Put the radiator back in vertical position and check the internal level of the liquid (fig. 4).
- 7) Ensure a proper fastening of the heating element in the radiator.
- 8) Connect the device to mains and start heating (the top opening of the radiator must remain open!).
- 9) Set the maximal temperature and check the level of the internal liquid.
  - Due to thermal expansion the liquid could brim over the radiator.
  - Remove the exceeding liquid (be careful to avoid burns!) in order to keep the thermostat dry and avoid the liquid reaching the border.
- 10) When the level of the liquid stops growing wait for additional 5 minutes then stop heating.

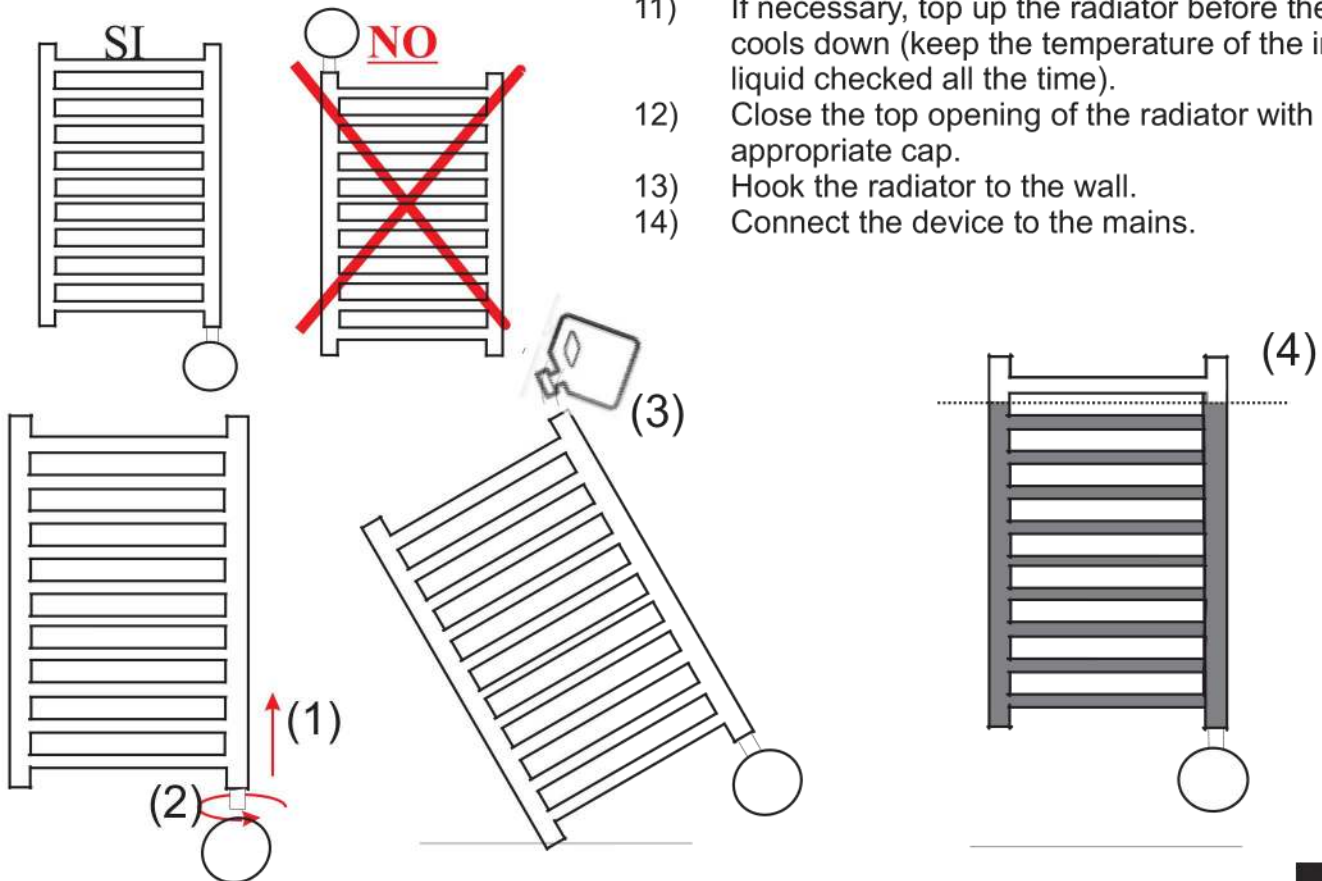

- 11) If necessary, top up the radiator before the liquid cools down (keep the temperature of the internal liquid checked all the time).
- 12) Close the top opening of the radiator with the appropriate cap.
- 13) Hook the radiator to the wall.
- 14) Connect the device to the mains.



## “SMART Thermostatic” Electronic control for towel radiators

### User manual

#### “Comfort Bar”:

Indicates the selected temperature and further accessory information

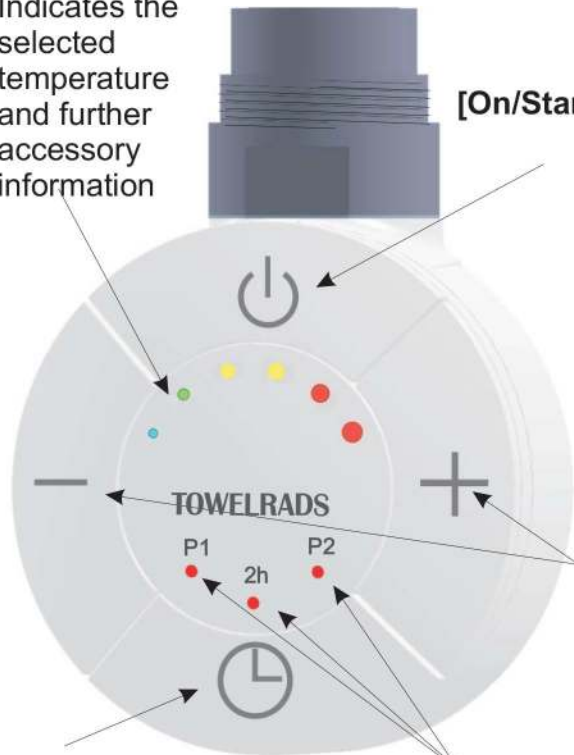

[On/Stand-by] button

1/2" GAS thread for fastening on the radiator

[+] and [-] buttons: For setting the desired temperature

[Boost/program] button: For choosing between on of: "Boost 2h", "P1" and "P2" modes.

3 red LEDs indicate to the user which mode is activated: "Boost 2h", "P1", "P2"

Heating element



Power cord

Internal NTC sensor: Used for automatic temperature control

#### Comfort bar

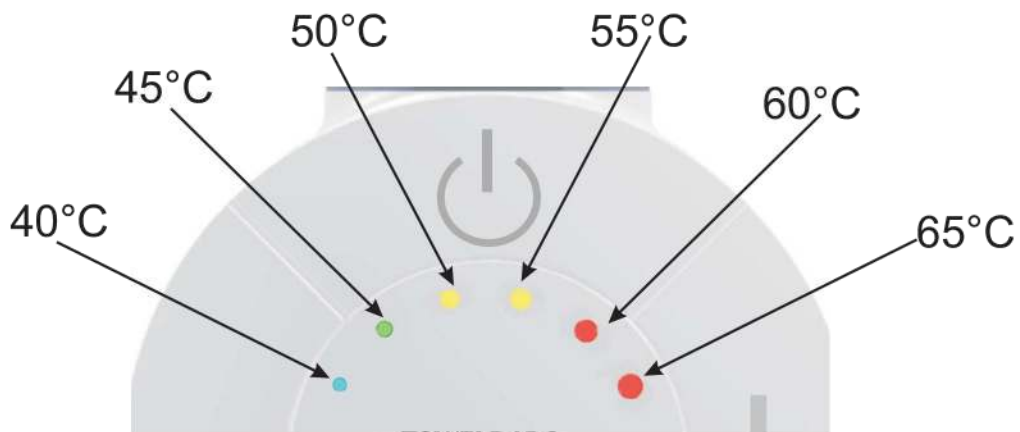

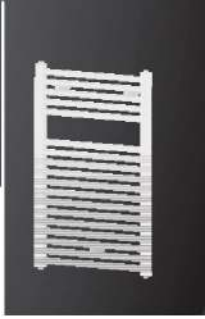

## “*SMART Thermostatic*” Electronic control for towel radiators

### User Guide

Press the [On/Standby] button to turn on the device or to enter the “Standby / Antifreeze” mode.

#### NOTE:

The device will beep twice for 0.5 seconds when put into "Standby/Antifreeze" mode.  
The device will beep once for 1 second when turned on.

**"Comfort" mode:** In this mode the desired temperature of the radiator is selected. The temperature value is set through the [+] and [-] buttons to one of the following values: 40°C, 45°C, 50°C, 55°C, 60°C, 65°C.

The rightmost lit or blinking LED in the “Comfort bar” indicates the selected temperature. A blinking LED indicates that the corresponding temperature has not yet been reached during the heating phase. When a certain temperature level is reached, the corresponding LED stops blinking and remains lit.



Turn on the device. Pressing 4 times the [+] button, the desired temperature is set to a value of 55°C (the first 4 LEDs from the left start blinking).



The radiator starts heating. When the temperature of the radiator reaches 40°C the first (blue) LED stops blinking and remains lit.



The temperature rises above 40°C



And so forth, to reach the led that indicates 55°C. When all the LEDs stop blinking, the radiator has reached the desired temperature.

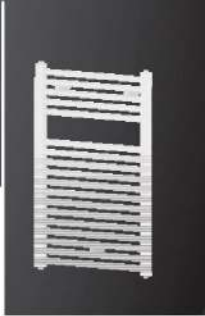

## “SMART Thermostatic” Electronic control for towel radiators

**"P1" mode:** to activate this mode press the **[Boost/program]** button until the led "P1" is lit.

In this mode the thermostat activates for 2 hours the "Boost" function; after 2 hours the thermostat returns to the "Comfort" mode for 22 hours. So long as this mode is not deactivated, this sequence is repeated cyclically.

To deactivate the function press the **[Boost/program]** button until you are returned the "Comfort" mode.

The "P1" blinks in the period the "Boost" mode is ON (2h).

The "P1" remains lit in the period the "Comfort" mode is ON (22h).

N.B. during the first cycle, the length of the "Comfort" mode is of 21 hours.

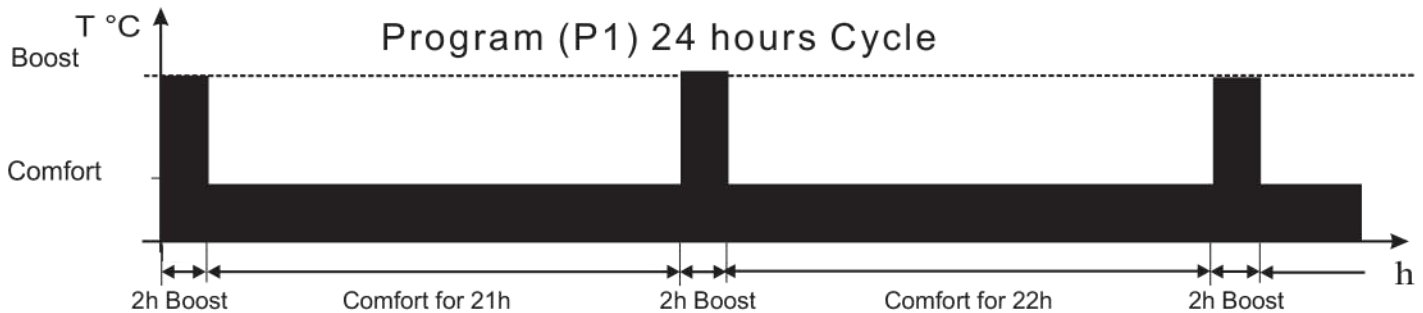

**"P2" mode:** to activate this mode press the **[Boost/program]** button until the led "P2" is lit.

In this mode the thermostat activates for 2 hours the "Boost" function; after 2 hours the thermostat returns to the "Comfort" mode for 10 hours. So long as this mode is not deactivated, this sequence is repeated cyclically.

To deactivate the function press the **[Boost/program]** button until you are returned the "Comfort" mode.

The "P2" blinks in the period the "Boost" mode is ON (2h).

The "P2" remains lit in the period the "Comfort" mode is ON (10h).

N.B. during the first cycle, the length of the "Comfort" mode is of 9 hours.

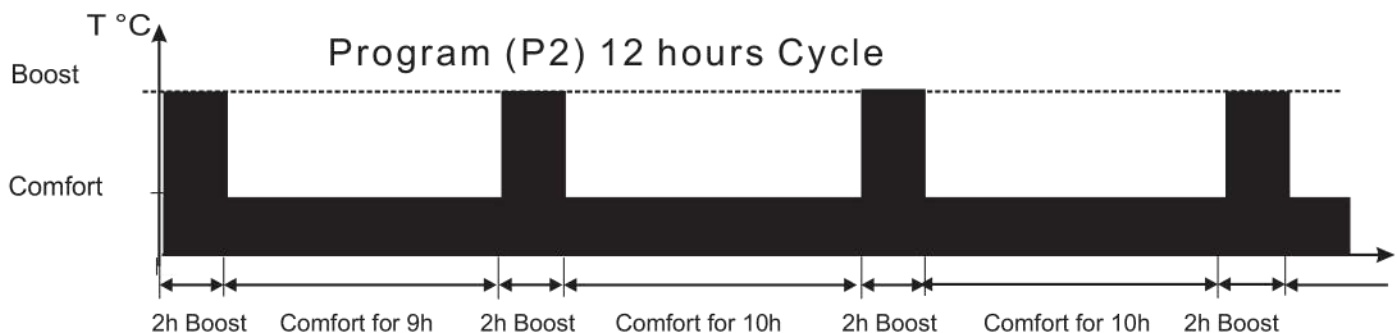

**N.B. The maximal temperature during the "Boost" period in "P1" and "P2" mode is limited to 65°C**



## “SMART Thermostatic” Electronic control for towel radiators

**"Boost 2h" mode:** to activate this mode press the **[Boost/program]** button until the "2h" led is lit.

This mode activates the heating element to the maximal power for 2h (for safety reasons the maximal temperature of the towel radiator is limited to 65°C).

To exit the "Boost" mode, press the **[Boost/program]** button until you return to the "Comfort" mode.

The 2h led remains lit for the whole time that the function is active.

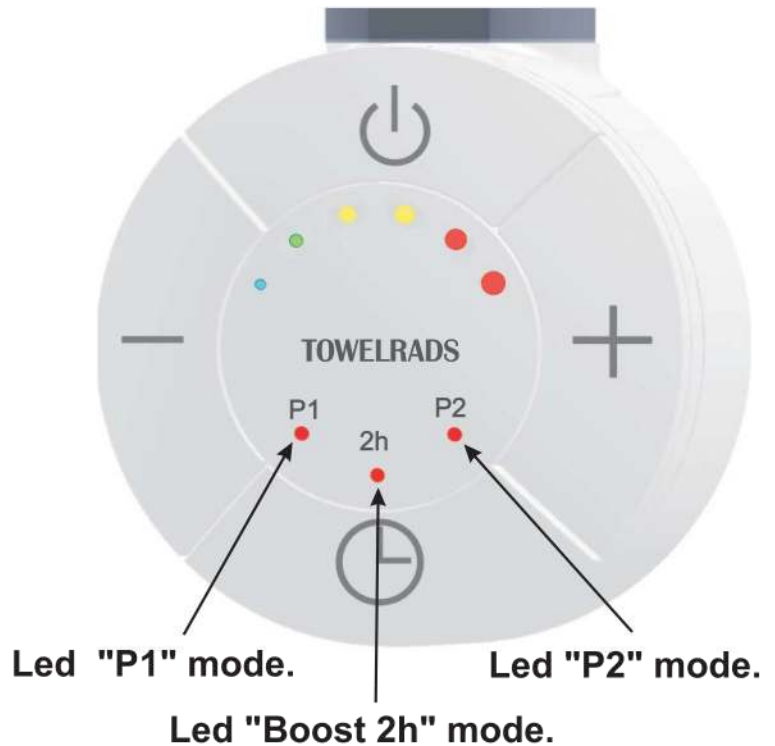

### Function diagrams

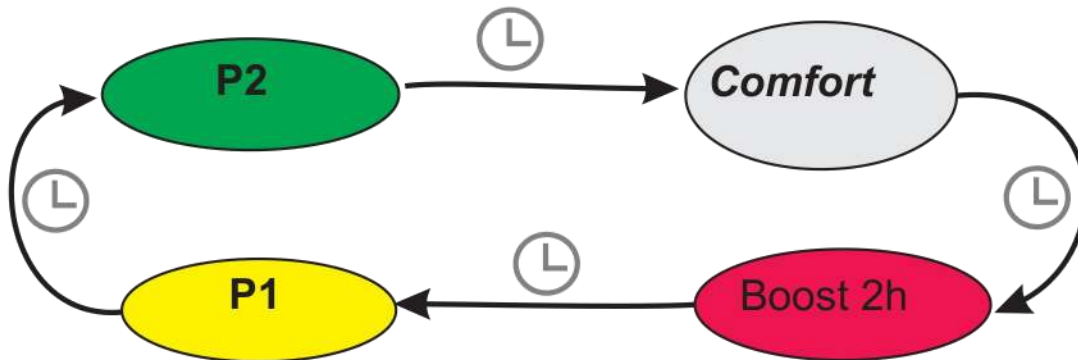

Press the **[Boost/Program]** button to select the operative mode



### Function diagram or Boost/Timer LEDs.

<b>2h red led blinking</b>	"Boost" active. The heating element is active for 120 minutes (the maximal temperature of the radiator is limited to 65°C).
<b>P1 red led blinking</b>	"Boost" (P1) active. The heating element is active for 120 minutes (the maximal temperature of the radiator is limited to 65°C).
<b>P1 red led</b>	Return to "Comfort" mode for 22h.
<b>P2 red led blinking</b>	"Boost" (P2) active. The heating element is active for 120 minutes (the maximal temperature of the radiator is limited to 65°C).
<b>P2 red led</b>	Return to "Comfort" mode for 10h.

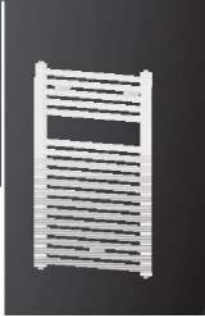

## “*SMART Thermostatic*” Electronic control for towel radiators

**Key-lock function:** press simultaneously the [+ ] and [- ] buttons for 3 seconds to activate the key-lock function, which prevents the inadvertent use of the keypad, with the exception of the [On/Standby] button. To deactivate the function, repeat the same procedure. When the key lock function is activated, the device beeps twice. When key lock is deactivated, the device beeps four times.

### Additional indications provided by the “Comfort Bar”:

- The two central (yellow) LEDs blink when a button is pressed: Key lock is active.
- The external (blue and red) external LEDs blink: Failure on the temperature sensor, the heating element is deactivated. Contact customer support.

### Notes.

In case of interruption of the power supply, the system will recover from the previous operative mode\*, with the exception of "Boost 2h", "P2" and "P1" modes.

\*the status of the thermostat is saved after 5 seconds from the last modification.

**Accessory:** To allow a mixed usage of the SMART device, connect the T-piece to the towel radiator, insert the SMART device into the vertical manifold of the T-piece and connect the return line of the heating circuit to the orthogonal connector of the T-piece.



**Available Colors:** White, Chrome.

**Repairing:** they must be carried out by authorized personnel in order not to void the warranty.

The manufacturer reserves the right to make any changes to the product described in this manual, at any time, and without prior warning.



### DISPOSAL

This product may not be treated as ordinary household waste. It has to be disposed in proper waste collection sites. In case of replacement it shall be returned to Towelrads.

Such an end-of-life treatment of the product will preserve the environment and will reduce consumption of natural resources.

This symbol applied to the present product indicates the obligation to bring it to a proper waste collection site, in order to let it be disposed according to 2012/19/EU (RAEE - WEEE) directives.