

 **TRIO**

**HF
TRANSCEIVER**

TS-130SE
TS-130S/TS-130V



The TS-130 Series is an incredibly compact, full-featured, reasonably priced, all solid-state HF SSB/CW transceiver for mobile and fixed operation. It covers 3.5 to 29.7 MHz (including the three new amateur bands!) and is loaded with operating features such as digital display, IF shift, speech processor, narrow/wide filter selection (for both SSB modes), and optional (DFC-230) digital frequency controller. The TS-130SE and TS-130S run high power, and the TS-130V is a low-power version for QRP operation.

80-10 METERS, INCLUDING THREE NEW BANDS

The TS-130 Series covers all amateur frequencies between 3.5 and 29.7 MHz, including the new 10, 18 and 24.5 MHz bands. It receives WWV on 10 MHz, for checking the calibration of the highly accurate digital display. Transmit and receive modes include LSB, USB and CW.

BUILT-IN SPEECH PROCESSOR

The speech processor in the TS-130 Series combines an audio compression amplifier with changes in ALC time constant to provide extra audio punch and to increase average SSB output power, while suppressing sideband splatter.

CW NARROW/WIDE SELECTION

The "N-W" switch allows selection of wide and narrow CW bandwidths, when an optional CW filter is installed.

In the wide ("W") position, the IF filter bandwidth is the same as in the SSB mode (2.4 kHz), for easy tuning of CW signals. In the narrow ("N") position, greater selectivity is provided if the optional YK-88C (500 Hz) or YK-88CN (270 Hz) CW filter is installed.

SSB NARROW SELECTION

The "N-W" switch, besides allowing selection of CW bandwidths, also allows a narrow SSB bandwidth to be selected, when the optional YK-88SN (1.8 kHz) filter is installed. This filter is especially handy during contests and in DX pileups, when QRM is especially heavy.

SIDEBAND MODE SELECTED AUTOMATICALLY

The appropriate sideband mode is selected automatically on each band (LSB on 80 and 40 meters, USB on 30 meters and above). A mode-switch position is also provided for reversing these modes.

OPTIONAL DFC-230 DIGITAL FREQUENCY CONTROLLER

Combined with the optional compact DFC-230 Digital Frequency Controller, the TS-130 Series has optimum frequency-control functions. The DFC-230 is compact enough for mobile operation, and features a 20 Hz step digital VFO, four memories, and digital display. Supplied with the DFC-230 is an UP/DOWN microphone which allows remote frequency control. The TS-130 Series may also be used with the VFO-120 or VFO-230, as well as the DFC-230.

OPTIMUM PERFORMANCE IN A COMPACT PACKAGE

Miniaturized circuits and all solid-state design have contributed to the extremely small size of the TS-130 Series as well as its optimum operating features and performance. The TS-130 Series is the ultimate HF transceiver for fixed or mobile use, and is easily transported to virtually any location for portable operation (such as Field Day, vacation sites, or DX-peditions).

ALL SOLID-STATE...EASY TO OPERATE

Two power versions are available in the TS-130 Series. The TS-130SE, TS-130S run 200W PEP/160W DC input on 80 - 15 meters and 160W PEP/140W DC on 12 and 10 meters. The TS-130V runs 25W PEP/20W DC input on all bands. A solid-state, wideband final amplifier in both versions eliminates transmitter tuning. Efficient wideband RF amplifier stages in the receiver eliminate preselector peaking as well. To operate, simply set the band switch and VFO to the desired frequency.

BUILT-IN DIGITAL DISPLAY

A standard feature in the TS-130 Series

SPEECH PROCESSOR WAVE FORM

OFF

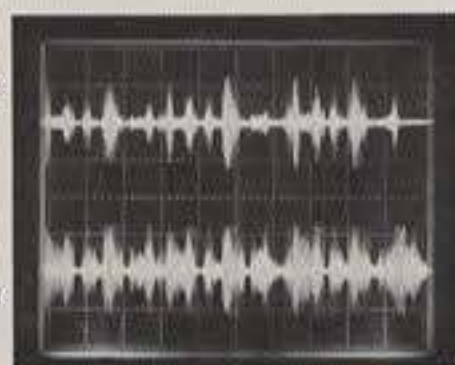

Compression level 10dB

ATTENUATION CHARACTERISTICS OF EACH FILTER

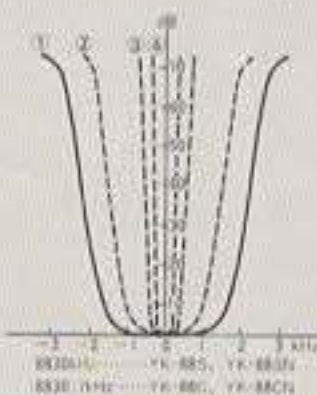

- ① Built-in SSB filter
- ② Optional YK-88SN (1.8kHz) filter
- ③ Optional YK-88C (500 Hz) filter
- ④ Optional YK-88CN (270 Hz) filter

SSB	WIDE	2.4 kHz
	NARROW	(1.8 kHz YK-88SN option)
CW	WIDE	2.4 kHz
	NARROW	(500 Hz YK-88C option) or (270 Hz YK-88CN option)

ired rea-
for both
(includ-
optimum
tech pro-
and CW
roller.
TS-130V



is a built-in digital frequency display. The six-digit display indicates actual operating frequency to 100 Hz on any band and in any mode without recalibration. The display also indicates remote VFO or fixed-channel frequency, RIT shift, and CW transmit/receive shifts. The display's green fluorescent tubes provide fatigue-free viewing over long operating periods. An analog subdial provides backup frequency indication continuously.

IF SHIFT ELIMINATES QRM

TRIO's famous IF shift system allows the IF passband to be moved around the received signal and away from interfering signals and sideband splatter. Selectivity improves even more with the installation of the optional YK-88SN 1.8 kHz filter, YK-88C 500 Hz filter, or YK-88CN 270 Hz filter.

INNOVATIVE SINGLE-CONVERSION PLL SYSTEM

The TS-130 Series utilizes a new PLL circuit which does not require a crystal element for each band. As shown in the diagram, the VCO frequency is obtained in the PLL circuit by synthesizing the VFO and CAR frequencies, the 10 MHz reference frequency supplied by the

counter, and the divided frequency of 500 kHz. Band changing is accomplished by changing the preset division ratio of the programmable divider in the PLL. This eliminates the need for a heterodyne crystal element for each operating band, resulting in simplification of circuitry, and a marked improvement in overall stability. The single-conversion PLL system also improves the spurious characteristics during transmission and reception, and makes IF shift operation and monodial indication available on any mode.

BUILT-IN RF ATTENUATOR

The carefully designed TS-130 Series receiver front-end includes a 20 dB RF attenuator which may be switched in to provide optimum rejection of intermodulation distortion.

BUILT-IN COOLING FAN (TS-130S ONLY)

When the temperature of the heatsink for the final amplifier rises to 90 degrees centigrade because of long transmissions, the cooling fan is activated automatically.

(FA-4: Cooling fan unit for TS-130SE)
—option

PROTECTION CIRCUIT FOR FINAL TRANSISTOR

To assure maximum reliability and performance, the final amplifier stage is protected through use of circuitry that monitors VSWR (TS-130SE, TS-130S and TS-130V), and temperature (TS-130SE, TS-130S). Output power is automatically reduced when either parameter is at variance with normal operating conditions.

Under operating conditions such as are typical in normal use, the built-in protective circuit will not ordinarily be called upon to perform its function. For those operators who engage in especially lengthy CW, AFSK, or other severe types of operation, a cooling fan unit model FA-4, is available. The fan is automatically switched on or off as necessary to minimize the possibility of a power reduction resulting from excessive temperature rise.

EXPANDED FREQUENCY COVERAGE

The TS-130 Series built-in stable VFO, as well as the optional VFO-120 remote VFO, covers more than 50 kHz above and below each 500 kHz band. The optional DFC-230 and VFO-230 cover about 100 kHz above and below each band.

HOW IF SHIFT ELIMINATES INTERFERENCE



① Center ③ Interference
② Shift width ④ Desired signal

SENSITIVITY/SUPPRESSION CHARACTERISTICS

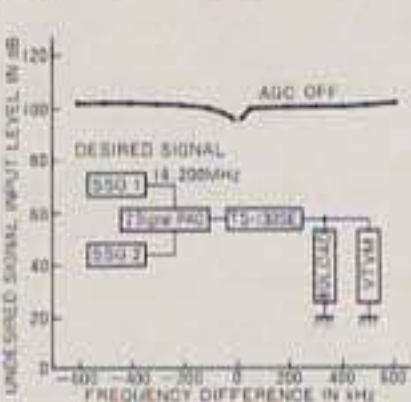

ADJACENT TRANSMIT SPURIOUS CHARACTERISTICS

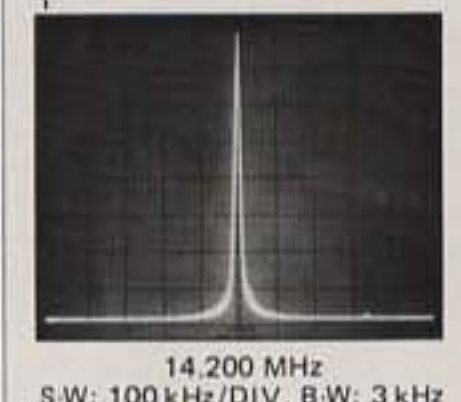

OUTPUT POWER (CW)

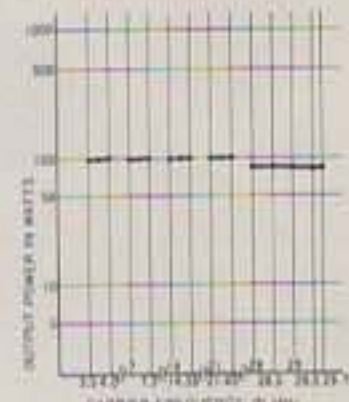

BUILT-IN VOX CIRCUIT

The compact TS-130 Series features VOX as well as push-to-talk operation. VOX gain, VOX delay, and anti-VOX controls are on top of the cabinet, for easy adjustment. The system also allows semi-break-in operation on CW, with the sidetone-oscillator circuit.

BUILT-IN NOISE BLANKER

The TS-130 Series features an effective noise-blanker circuit. A new type of filter on the input circuit of the noise blanker minimizes the effects of adjacent-channel signals on the operation of the blanker. The noise blanker eliminates pulse-type interference such as ignition noise, which can be a problem particularly on the higher HF bands.

ENHANCED SELECTIVITY WITH INNOVATIVE MCF

IF selectivity in the TS-130 Series is determined by a new type of monolithic crystal filter. The built-in SSB filter and the optional YK-88SN, YK-88C and YK-88CN filters have the same outstanding characteristics as an eight-pole crystal filter, but are manufactured in much smaller packages.

BUILT-IN 25 kHz MARKER

A built-in marker provides 25 kHz signals

FREQUENCY COMPOSITION DIAGRAM

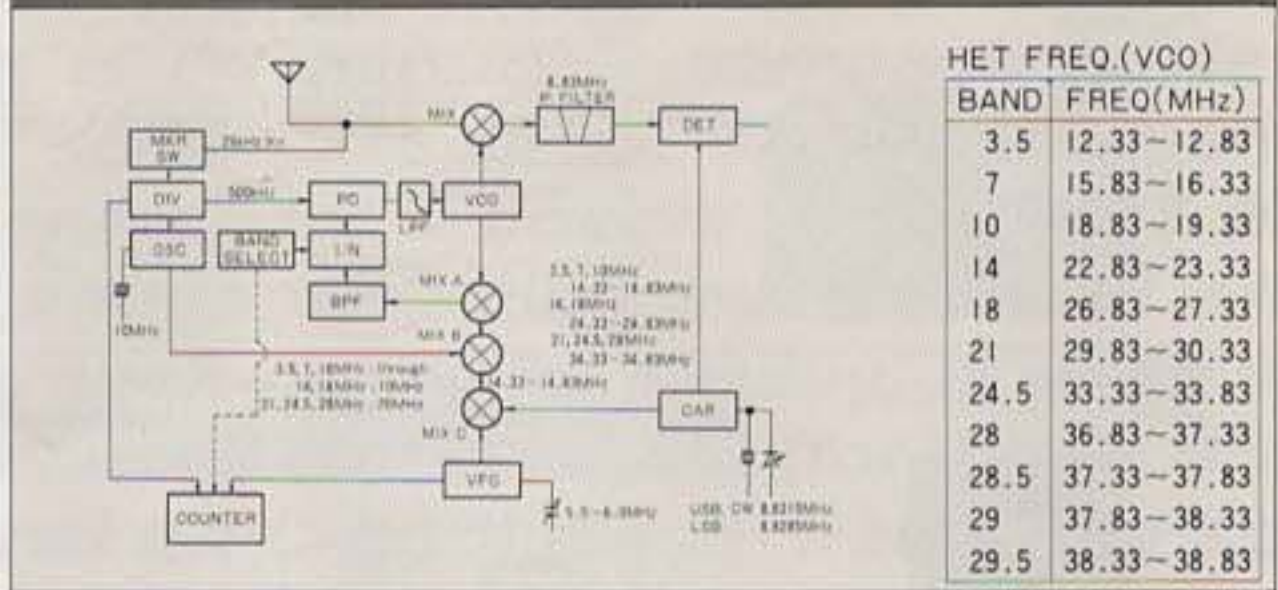

which are derived from the 10 MHz master oscillator. The 25 kHz marker provides an accurate frequency reference for the TS-130 Series or any other rig to be calibrated.

RUGGED CONSTRUCTION AND HANDSOME STYLING

The TS-130 Series is styled to enhance the appearance of any fixed or mobile station, while providing maximum ease of operation with a functional layout of controls. The transceiver, with its front panel of rugged alloy die casting and advanced mechanical engineering throughout, will take virtually any rough treatment typically encountered in mobile, portable, or contest operation.

OTHER VERSATILE PROVISIONS

- The front-panel meter functions as an S-meter on receive and as an Ic (TS-130SE, TS-130S) or RF (TS-130V) meter and ALC meter (for adjusting microphone gain) on transmit.
- FIX channel capability.
- Built-in 25 kHz Marker.
- RIT, VFO, and FIX front-panel LED indicators.
- Capability to operate with any impedance microphone from 500Ω to 50 kΩ.
- Accessory terminal for use with linear amplifier or other equipment.

TS-130SE/130S/130V BLOCK DIAGRAM

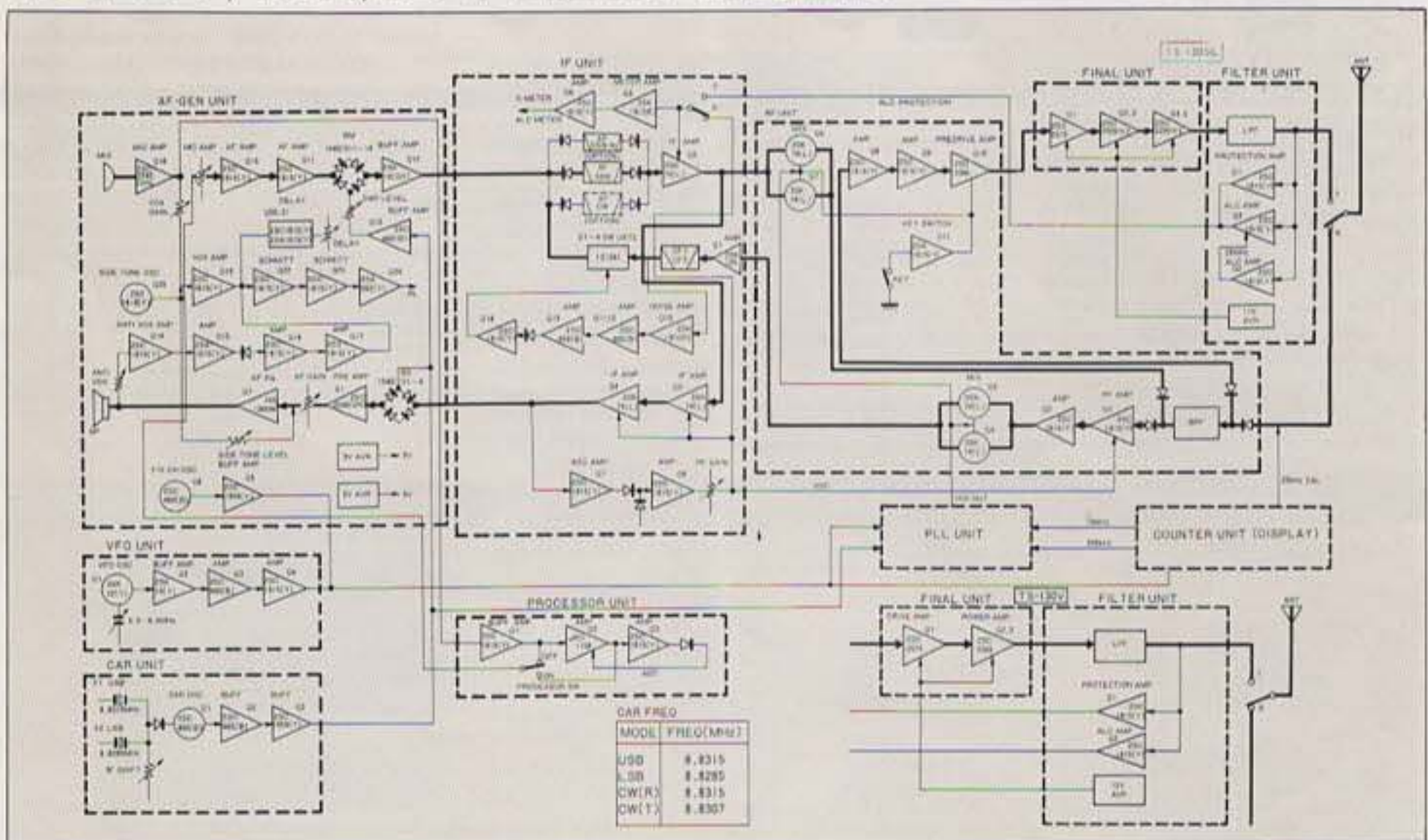

OPTIONAL ACCESSORIES

TL-922 HF Linear Amplifier



The TL-922 is an HF linear amplifier operating at maximum legal power, and employing a pair of 3-500Z high performance transmitting tubes. (Without the three new amateur bands.)

FEATURES

- Employment of high performance transmitting tube, EIMAC 3-500Z (option) • AB₂ class G-G circuit • Excellent IMD (intermodulation products distortion) characteristics • Perfect safety protection • Newly developed DELAY circuit of blower stop • Variable threshold level type ALC circuit • Employment of eye-ease two meter system • Matching with TRIO HF transceivers and transmitters.

SPECIFICATIONS

- Frequency range: 160 meter band = 1.8 to 2.0 MHz, 80 meter band: 3.5 to 4.0 MHz, 40 meter band = 7.0 to 7.3 MHz, 20 meter band = 14.0 to 14.35 MHz, 15 meter band = 21.0 to 21.45 MHz, 10 meter band = 28.0 to 29.7 MHz
- Mode: SSB, CW, RTTY • Drive power: 80W or more for full output • RF input power: SSB = 2,000W PEP, CW/RTTY = 1,000W DC • Circuitry: AB₂ Class grounded-grid linear amplifier • Input impedance: 50Ω • Output impedance: 50 to 75Ω • Tubes: EIMAC 2 x 3-500Z (option) • Power requirement: 220/240V AC, 50/60 Hz • Dimensions: 390 (15.6)W x 190 (7.6)H x 407 (16.3)D mm (inch) • Weight: 31 kg (68.2 lbs.)

VFO-230 Digital Remote VFO



MA-5 5 Band Helical Type HF Mobile Antenna

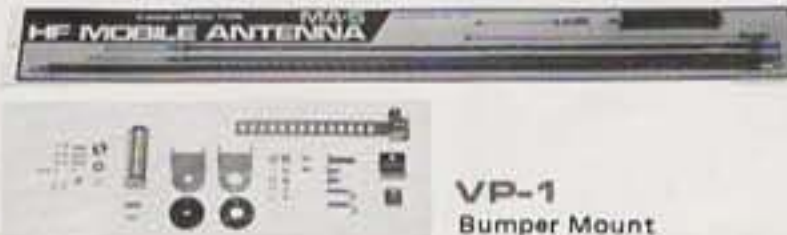

TL-120 HF Linear Amplifier

(Without the three new amateur bands.)
Can be used with TS-130V / TS-120V.

3.5 ~ 21 MHz	SSB 200W PEP CW 160W DC
28 MHz	SSB 160W PEP CW 140W PEP



FA-4 Fan Unit (For TS-130SE)

Power source: From TS-130SE
Dimensions: 150.5 (6.0)W x 89.5 (3.6) mm (inch)
Weight: 170g (0.37 lbs.)



YK-88SN 1.8 kHz SSB narrow filter

YK-88CN
270 Hz CW narrow filter
YK-88C
500 Hz CW filter



MB-100 Mobile Mount



HC-10 Digital World Clock



MC-60 (N4) (50kΩ/500Ω) Deluxe Desk Top Microphone



MC-50 (50kΩ/500Ω) Desk Top Microphone



MC-30S (500Ω) MC-35S (50kΩ) Noise-Cancelling Hand Microphones



SP-40 (4Ω) Compact Mobile Speaker



HS-6 (12.5Ω) Light-weight Headphones



HS-5 (8Ω) Deluxe Headphones



HS-4 (8Ω) Headphones



RD-20 (For TS-130V) RF Dummy Load (20W Continuous)



TS-130SE/130S/130V SPECIFICATIONS

[GENERAL]

Frequency range:

80m band	3.5 ~ 4.0 MHz
40m band	7.0 ~ 7.3 MHz
*30m band	10.1 ~ 10.15 MHz (10.0 MHz WWV)
20m band	14.0 ~ 14.35 MHz
*17m band	18.068 ~ 18.168 MHz
15m band	21.0 ~ 21.45 MHz
*12m band	24.89 ~ 24.99 MHz
10m band	28.0 ~ 29.7 MHz

* Receive only. (Transmission on these bands is possible with a small modification.)

Mode: SSB/CW
Frequency stability: Within 100 Hz during any 30 minute period after warmup. Within ±1 kHz during the first hour after 1 minute of warmup.

RF output impedance: 50Ω

Power requirement:

TS-130SE/130S		TS-130V	
RX: 0.7A	13.8V DC	RX: 0.7A	13.8V DC
TX: 19A	13.8V DC	TX: 4A	13.8V DC

Dimensions:

TS-130SE/130S		TS-130V	
241 (9.6)W x 94 (3.8)H		241 (9.6)W x 94 (3.8)H	
x 293 (11.7)D mm (inch)		x 235 (9.4)D mm (inch)	

Weight:

TS-130SE/130S		TS-130V	
5.6 kg (12.3 lbs.)		4.9 kg (10.8 lbs.)	

[TRANSMITTER]

Final power input:

TS-130SE/130S	TS-130V
80m ~ 15m band 200W PEP for SSB operation 160W DC for CW operation	All band 25W PEP for SSB operation 20W DC for CW operation
12m ~ 10m band 160W PEP for SSB operation 140W DC for CW operation	

Carrier suppression: Better than 40 dB
Unwanted sideband suppression: Better than 50 dB
Spurious radiation: Better than 40 dB
Audio input impedance: 500Ω ~ 50 kΩ

[RECEIVER]

Sensitivity: 0.25 μV at 10 dB S/N

Selectivity:

• SSB/CW WIDE = 2.4 kHz (-6 dB), 4.2 kHz (-60 dB)
SSB NARROW = 1.8 kHz (-6 dB), 3.3 kHz (-60 dB)
with optional YK-88SN filter
CW NARROW = 500 Hz (-6 dB), 1.5 kHz (-60 dB)
with optional YK-88C filter
or 270 Hz (-6 dB), 1.5 kHz (-60 dB)
with optional YK-88CN filter

Image ratio: Better than 50 dB
IF rejection: Better than 70 dB
Audio output power: 1.5W
Audio output impedance: 4 ~ 16Ω

Note: Circuit and ratings may change without notice due to developments in technology.



DFC-230
Digital Frequency Controller



The very compact DFC-230 digital frequency controller provides maximum efficiency and flexibility for mobile and fixed operation, by combining a 20 Hz step digital VFO with four memories.

FEATURES

- 20 Hz step digital VFO: Highly stable, with smooth tuning
- For memories: Frequency can be transferred from VFO to memory or from memory to VFO. An audible "beep" indicate memory input and recall
- Built-in digital display: Shows digital VFO or memory frequency. The display range is selected automatically to cover 900.0-599.9 or 400.0-099.9, according to the band
- Compact size: Only 148 (5.9)W x 51 (2.0)H x 166 (6.6)D mm (inch). Perfect for mobile installation
- UP/DOWN manual scan: Frequency can be shifted with UP/DOWN microphone (supplied with DFC-230) or with FAST/STEP switch on front panel. Scan speed is selectable in single, slow, or fast continuous 20 Hz steps from the UP/DOWN microphone.
- Cross-operation switch: Allows split frequency operation, with transceiver VFO on transmit and DFC-230 (VFO or memory) on receive, or vice versa
- RIT (receiver incremental tuning): Wide frequency range with either digital VFO or memory, using the main tuning knob, UP/DOWN microphone, or FAST/STEP switch, while RIT switch is on
- Expanded frequency coverage: About 100 kHz above and below each 500 kHz band.
- RIT, VFO, and MEMO indicators: LEDs show functions in operation
- Compatibility with TS-130SE/130S/130V, TS-830S, and TS-120S/120V.

SPECIFICATIONS

- Oscillating frequency: 5.4-6.1 MHz
- Frequency Stability: 1×10^{-5} (at normal temperature), 3×10^{-5} (0-50°C)
- Output Signal: 0.2V +3 dB, -1 dB
- Power requirement: 9V DC, 30 mA, 13.8V DC, 300 mA (obtained from TS-130SE/130S/130V, TS-830S, or TS-120S/V)
- Dimensions: 148 (5.9)W x 51 (2.0)H x 166 (6.6)D mm (inch)
- Weight: 1.3 kg (2.9 lbs.)

VFO-120
Remote VFO



Allows split-frequency operation when DX chasing, net monitoring, and finding an unused frequency while retaining the original frequency.

The VFO-120 also incorporates T.F.SET switch which prevents transmitting on the wrong frequency during split-frequency operation and also allows quick setting of transmit frequency. LED indicators show VFO functions at a glance.

SPECIFICATIONS

- Oscillator frequency: 5.5-6.0 MHz
- Oscillator circuit: Clapp
- Output voltage: 0.2V ± 1 dB
- Frequency stability: Within 100 Hz per 30 minutes after 3 minutes warm-up
- Power source: From TS-130 SE/130S/130V.
- Dimensions: 123 (4.9)W x 96 (3.8)H x 235 (9.4)D mm (inch)
- Weight: 2.5 kg (5.5 lbs.)

PS-30
DC Power Supply
(For TS-130SE/130S
and TL-120)



Supplies regulated 13.8V DC at 20A intermittent load with complete ease and safety due to the use of generous heat sinks and an automatic reset electronic overload trip.

SPECIFICATIONS

- Power consumption: approx. 470W
- Output voltage: 13.8V DC
- Output current: 20A (intermittent load 50% duty cycle), 15A (continuous load current)
- Output voltage fluctuation: Within ±700 mV (at 20A load current), Within 400 mV at 2-20A load current
- Ripple voltage: less than 20 mV at 13.8V DC, 20A
- Power requirements: 220/240V AC
- Dimensions: 180 (7.2)W x 133 (5.3)H x 287 (11.5)D mm (inch)
- Weight: 8.9 kg (19.6 lbs.)

PS-20
DC Power Supply
(For TS-130V)



Supplies regulated 13.8V DC at 4A continuous, 4.5A intermittent load with complete ease and safety due to the use of generous heat sinks and an automatic reset electronic overload trip.

SPECIFICATIONS

- Power consumption: approx. 100W
- Output voltage: 13.8V DC
- Output current: 4.5A (intermittent load 50% duty cycle), 4A (Continuous load current)
- Output voltage fluctuation: Within ±50 mV (at load current 4A), Within 0.1V at 0-4A of load current
- Ripple voltage: less than 5 mV at 13.8V DC, 4A
- Power requirements: 220/240V AC
- Dimensions: 123 (4.9)W x 96 (3.8)H x 235 (9.4)D mm (inch)
- Weight: 3.8 kg (8.4 lbs.)

SP-120
External Speaker



An attractive, compact speaker to match the TS-130SE/130S/130V styling. It is designed for fixed-station use. This low-distortion speaker provides clear reproduction of the high-quality audio from the TS-130SE/130S/130V.

SPECIFICATIONS

- Speaker diameter: 7.5 cm
- Max. input power: 1W
- Input impedance: 8Ω
- Frequency response: 300 Hz - 5 kHz
- Dimensions: 123 (4.9)W x 96 (3.8)H x 235 (9.4)D mm (inch)
- Weight: 1.3 kg (2.9 lbs.)

AT-130
Antenna Tuner



The AT-130 is a compact and lightweight antenna tuner designed for base or mobile use. (Includes the new three bands.)

SPECIFICATIONS

- (Antenna Coupler)
- Frequency range: 8 amateur bands from 3.5 to 29.7 MHz
- Input impedance: 50Ω
- Output impedance: 20 to 300Ω unbalanced
- Through power: 150W max. (3.5 MHz band, 120W)
- Insertion loss: less than 0.5 dB at optimum match (SWR meter)
- Frequency range: 3.5 to 29.7 MHz
- Max. power: 150W
- Measurable range: 1 : 1 to 10 : 1
- Min. power required: 2W (General)
- INPUT connector: UHF type (50Ω)
- ANT connector: UHF type (50Ω) GND: Wing nut and STUD
- Dimensions: 152 (6.1)W x 60 (2.4)H x 159 (6.4)D mm (inch)
- Weight: 1.6 kg (3.5 lbs.) approx.

Distributed by

LOWE ELECTRONICS LTD.

Bentley Bridge Chesterfield Rd. Matlock Derbyshire DE4 5LE, England

A product of

TRIO-KENWOOD CORPORATION

17-5, 2-chome, Shibuya, Shibuya-ku, Tokyo 150, Japan