

4-LAYER INSTRUCTIONS

Please read the installation manual carefully before use

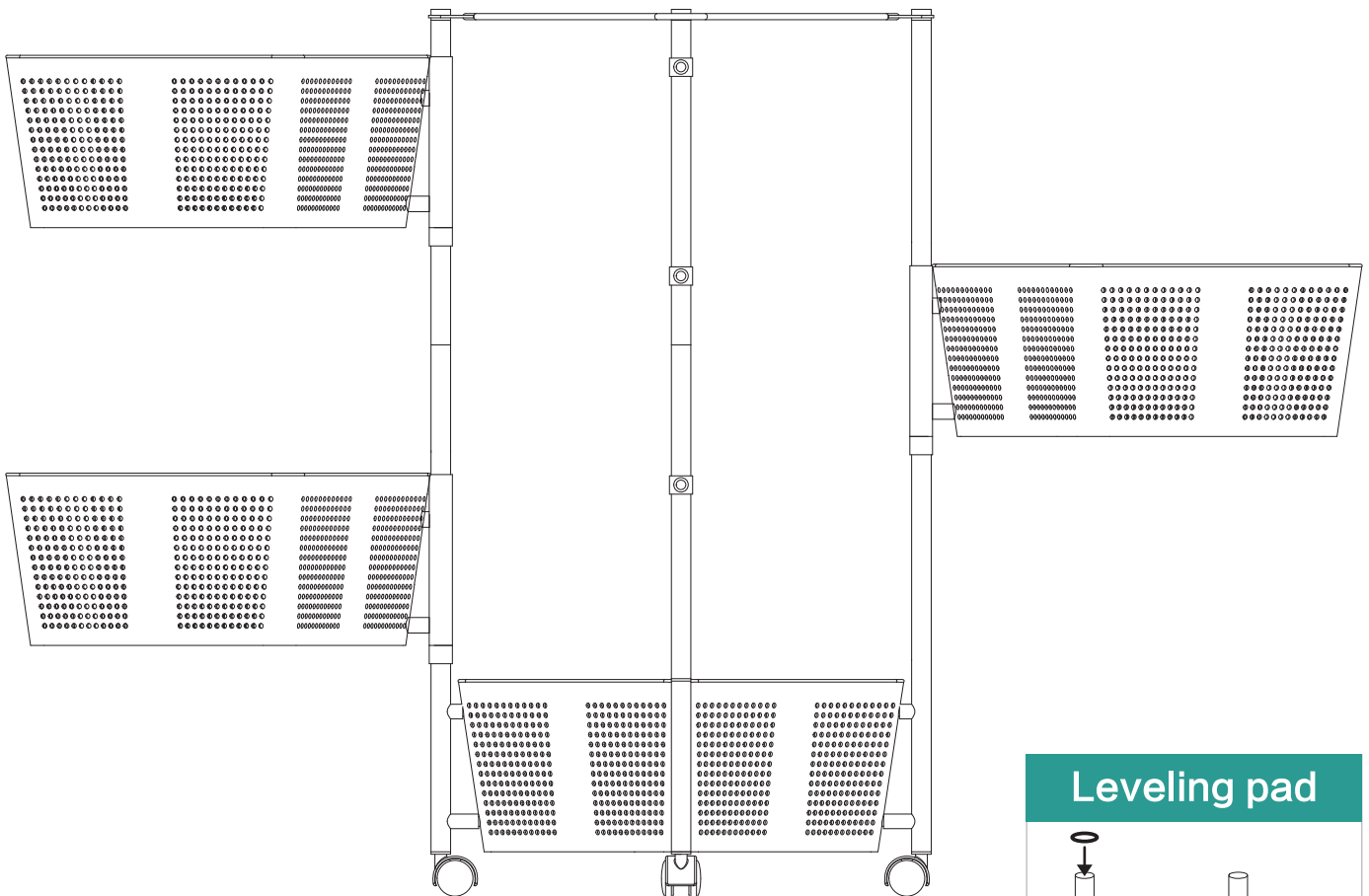

Leveling pad

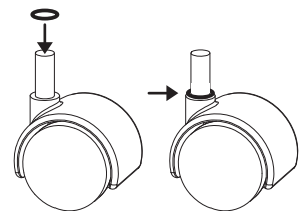

The leveling pad is presented as a gift. If the four feet are uneven, please insert it into the wheel for use.



Warm tips:

1. Please put the heavy objects on the bottom basket;
2. Keep left and right balance when rotating and opening;
3. The basket shall be closed and put back after taking and placing articles;

* Due to product update and iteration, or there is a slight deviation between the appearance of some products and the real thing, please refer to the real thing

• Accessories List

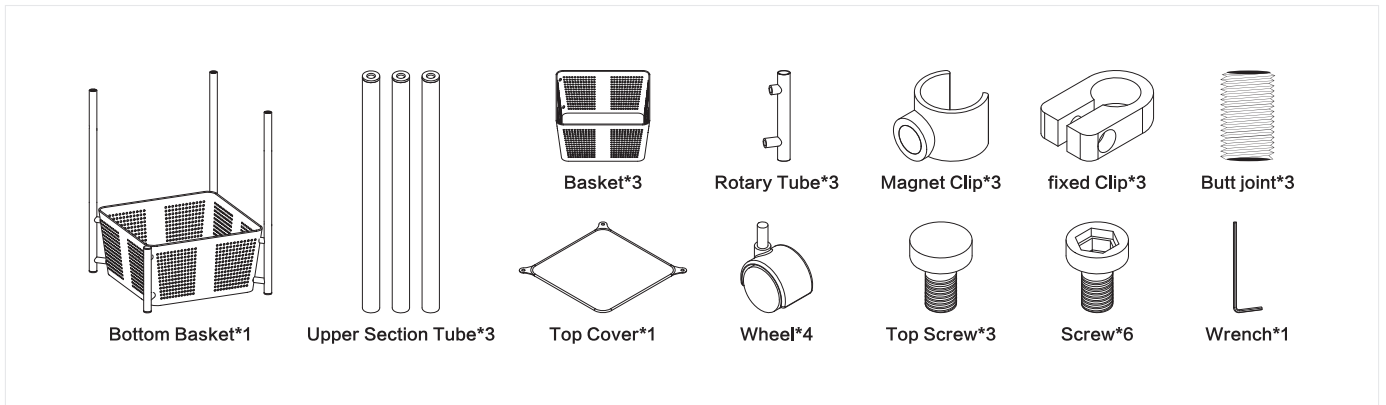

⚠ Please check whether the quantity of accessories is complete before installation

• Installation procedure

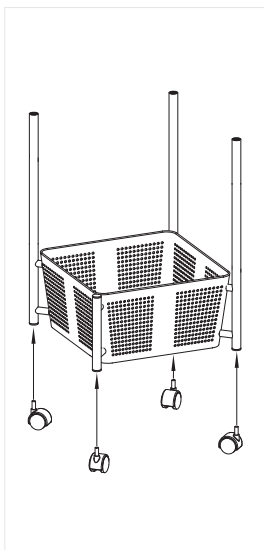

1. Insert the wheels into the bottom hole.

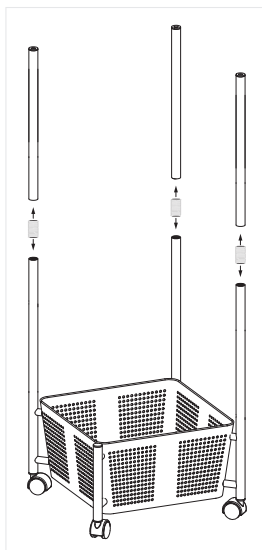

2. Install the upper pipe section and lock the joint connection through the screw thread

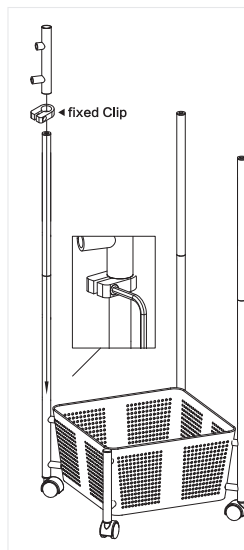

3. Install fixed clip and put the rotary tube in, one rotary tube must have one fixed clip to avoid it run up and down.

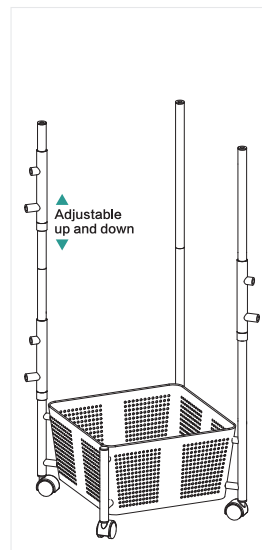

4. See picture above, fixed clip and rotary tube finished

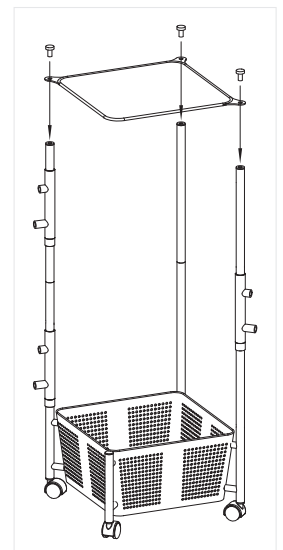

5. Install top cover and use top screws to fix it.

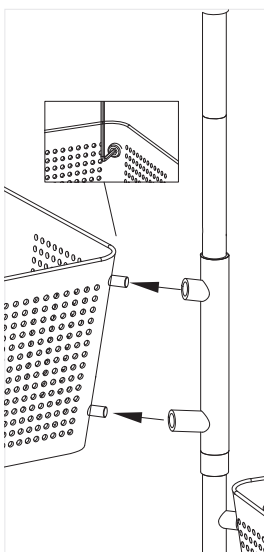

6. Install the baskets, make sure the holes and rotary tubes are in right position and lock screw tightly.

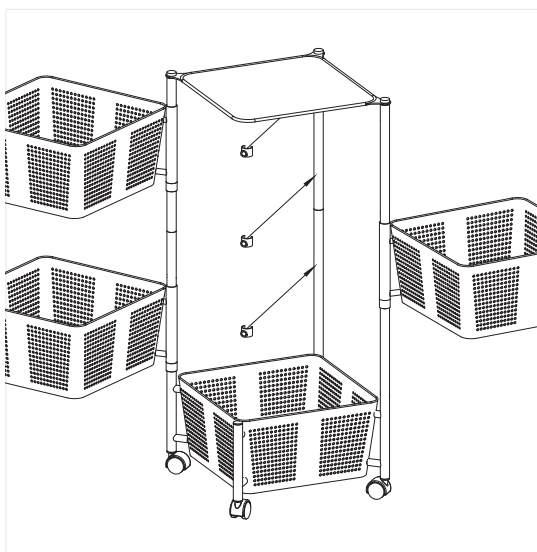

7. Put the magnet clip in suitable position, to pull the baskets.

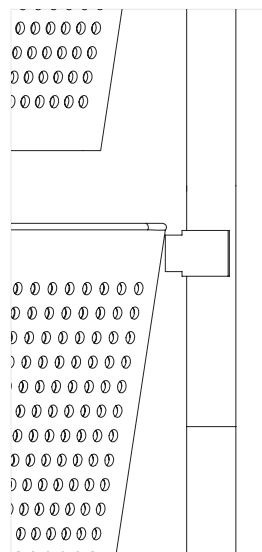

8. See picture above, magnet clip position.

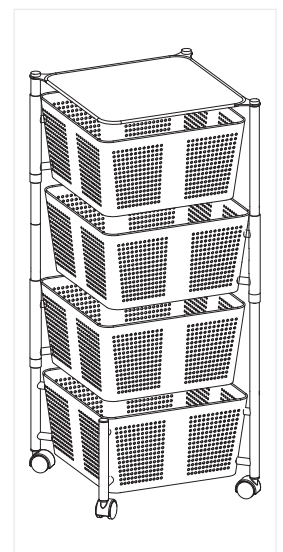

9. Installation completed